

# RTK0EE0013D10001BJ

## Electrical Characteristics of 915-MHz-Band RF Transceiver (FCC Part 15.247)

### Introduction

This document shows the electrical characteristics measurement results in the 915 MHz band with the RF part of the RTK0EE0013D10001BJ (R9A06G062GNP FCC-Compliant Sub-GHz Wireless Communication Evaluation Kit). The target regulation is “FCC Part 15.247” and the frequency band is 902MHz to 928MHz.

Note: The contents of this document are provided as an example for reference and do not guarantee the signal quality in systems. When implementing this example into an existing system, thoroughly evaluate the product in the overall system and apply the contents of this document at your own responsibility.

### Target Device

R9A06G062GNP

### Contents

1. Evaluation condition .....	3
1.1 System configuration.....	3
1.2 Temperature and supply voltage conditions .....	3
2. Electrical Characteristics .....	4
2.1 Current Characteristics.....	4
2.1.1 FSK (50kbps, modulation index = 1).....	4
2.1.2 OFDM (Option1, MCS6).....	4
2.2 TX Electrical Characteristics .....	5
2.2.1 FSK (50kbps, modulation index = 1).....	5
2.2.2 FSK (150kbps, modulation index = 0.5).....	10
2.2.3 OFDM (Option1, MCS6).....	15
2.2.4 OFDM (Option2, MCS6).....	20
2.2.5 OFDM (Option3, MCS6).....	25
2.2.6 OFDM (Option4, MCS6).....	30
2.3 RX Electrical Characteristics.....	35
2.3.1 FSK (50kbps, modulation index = 1).....	35
2.3.2 FSK (150kbps, modulation index = 0.5).....	38
2.3.3 OFDM (Option1, MCS6).....	41
2.3.4 OFDM (Option2, MCS6).....	44
2.3.5 OFDM (Option3, MCS6).....	47
2.3.6 OFDM (Option4, MCS6).....	50
3. Characteristics of FHSS operation .....	53
3.1 FSK.....	53
3.2 OFDM.....	55

4. Detailed information on the Evaluation Kit..... 57

Revision History ..... 58

## 1. Evaluation condition

### 1.1 System configuration

Figure 1 shows the RF part of Evaluation kit to be evaluated. Table 1 shows common evaluation conditions. The evaluation target described in this document is Daughter Board of Evaluation kit. The configuration of the evaluation kit including the motherboard can viewed at be the user's manual (r02uz0004ejxxx-sub-ghz).

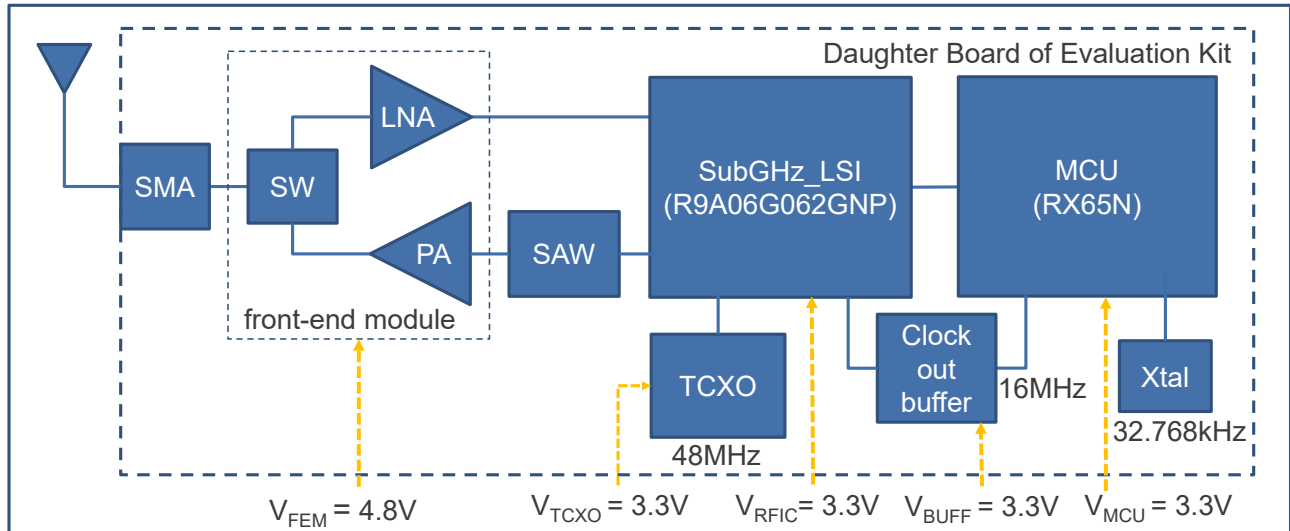


Figure 1 System configuration

### 1.2 Temperature and supply voltage conditions

Table 1 shows the temperature and voltage settings for each part during evaluation.

Table 1 Temperature and supply voltage conditions

Item	Conditions
Temperature	25deg C
MCU Main clock	96MHz
V <sub>FEM</sub>	Voltage supplied to FEM
V <sub>TCXO</sub>	Voltage supplied to TCXO
V <sub>RFIC</sub>	Voltage supplied to R9A06G062GNP
V <sub>BUFF</sub>	Voltage supplied to Clock out buffer IC
V <sub>MCU</sub>	Voltage supplied to MCU

## 2. Electrical Characteristics

### 2.1 Current Characteristics

#### 2.1.1 FSK (50kbps, modulation index = 1)

Table 2 shows the current value in each mode for each power supply.

**Table 2 Current Characteristics**

Item		RF Frequency [MHz]	TX Power [dBm]	Unit	Evaluation results
TX Mode	V <sub>RFIC</sub>	915.0	+28	mA	24.6
	V <sub>FEM</sub>			mA	536.2
	V <sub>MCU</sub>			mA	15.2
RX Mode	V <sub>RFIC</sub>	915.0	-	mA	17.5
	V <sub>FEM</sub>			mA	6.3
	V <sub>MCU</sub>			mA	15.2
Idle Mode	V <sub>RFIC</sub>	915.0	-	mA	5.8
	V <sub>FEM</sub>			uA	6.6
	V <sub>MCU</sub>			mA	15.1

#### 2.1.2 OFDM (Option1, MCS6)

Table 3 shows the current value in each mode for each power supply.

**Table 3 Current Characteristics**

Item		RF Frequency [MHz]	TX Power [dBm]	Unit	Evaluation results
TX Mode	V <sub>RFIC</sub>	915.2	+23	mA	39.8
	V <sub>FEM</sub>			mA	270.7
	V <sub>MCU</sub>			mA	15.2
RX Mode	V <sub>RFIC</sub>	915.2	-	mA	22.5
	V <sub>FEM</sub>			mA	6.3
	V <sub>MCU</sub>			mA	15.2
Idle Mode	V <sub>RFIC</sub>	915.2	-	mA	5.8
	V <sub>FEM</sub>			uA	6.6
	V <sub>MCU</sub>			mA	15.1

## 2.2 TX Electrical Characteristics

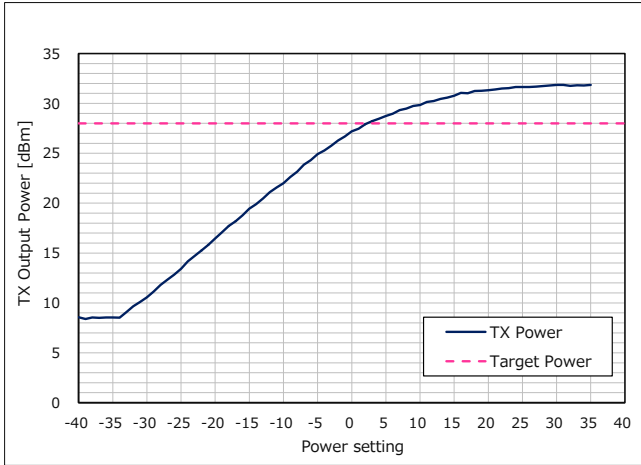
### 2.2.1 FSK (50kbps, modulation index = 1)

#### (1) TX Power sweep characteristics

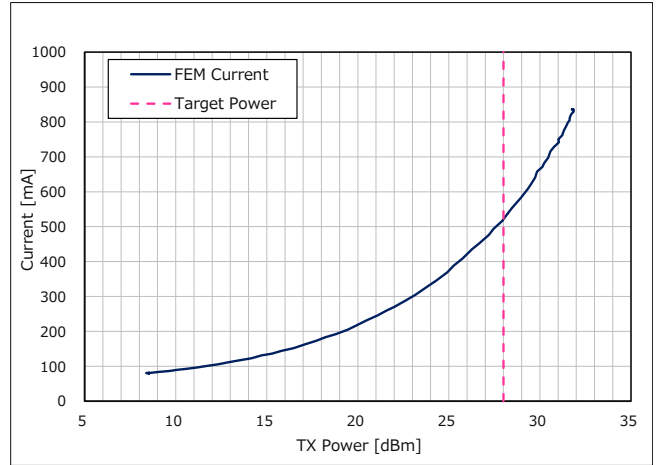
Signal condition: Frequency = 915MHz

**Table 4 TX Power sweep characteristics**

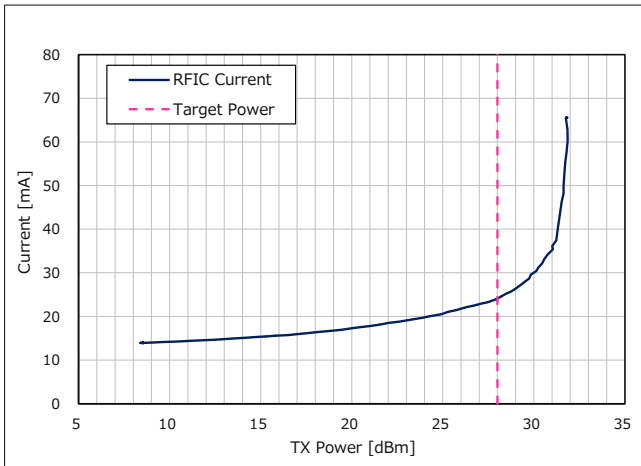
Items		Unit	Evaluation results
TX Power Range	Max	dBm	+31.8
	Min		8.5
	Variable power range	dB	23.3
Current Range	V <sub>FEM</sub>	Max	836.0
		Min	80.8
	V <sub>RFIC</sub>	Max	65.6
		Min	13.9



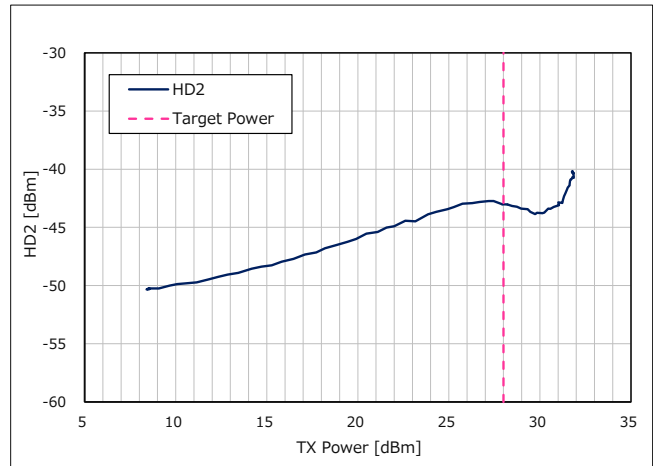
**Figure 2 Power Setting vs. TX Power (Frequency = 915MHz)**



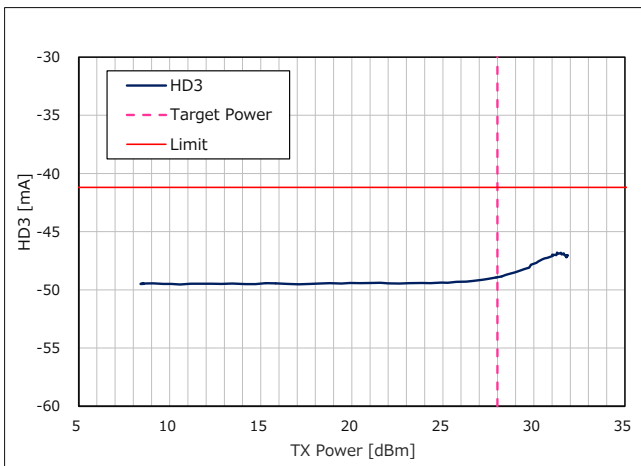
**Figure 3 TX Power vs. Current of  $V_{FEM}$  for TX mode (Frequency = 915MHz)**



**Figure 4 TX Power vs. Current of  $V_{RFIC}$  for TX mode (Frequency = 915MHz)**



**Figure 5 TX Power vs. 2nd Harmonics (Frequency = 915MHz)**



**Figure 6 TX Power vs. 3rd Harmonics (Frequency = 915MHz)**

**(2) TX Radio Regulations characteristics**

Signal condition: Target TX Power = +28dBm

**Table 5 TX Radio Regulations characteristics (1/2)**

Items		RF Frequency [MHz]	Unit	Evaluation results	Spec
TX Power		902.2	dBm	28.5	+30.0 (*1)
		915.0		28.4	
		927.8		28.2	
Harmonics	2nd	902.2	dBm /MHz	-44.4	-
		915.0		-43.1	
		927.8		-42.6	
	3rd	902.2		-48.2	-41.2 (*1)
		915.0		-48.8	
		927.8		-48.7	
Occupied Bandwidth		902.2	kHz	86.6	-
		915.0		86.0	
		927.8		86.1	
6dB Bandwidth (*2)		902.2	kHz	53.6	-
		915.0		53.7	
		927.8		53.6	
20dB Bandwidth (*2)		902.2	kHz	91.0	-
		915.0		91.7	
		927.8		92.7	
Adjacent Channel Power Ratio (M1_Lower, 150 kHz offset) (*3)		902.2	dBc	-56.8	-25 (*5)
		915.0		-56.7	
		927.8		-56.1	
Adjacent Channel Power Ratio (M1_Upper, 150 kHz offset) (*3)		902.2	dBc	-57.3	-25 (*5)
		915.0		-56.9	
		927.8		-56.5	
Adjacent Channel Power Ratio (M2_Lower, 300 kHz offset) (*3)		902.2	dBc	-64.3	-35 (*5)
		915.0		-63.7	
		927.8		-63.2	
Adjacent Channel Power Ratio (M2_Upper, 300 kHz offset) (*3)		902.2	dBc	-64.3	-35 (*5)
		915.0		-63.7	
		927.8		-63.4	
Deviation Offset		902.2	% rms	3.6	30 (*4)
		915.0		3.7	
		927.8		3.8	
Zero Crossing Error		902.2	% pk	-1.1	±12.5 (*4)
		915.0		1.3	
		927.8		-1.2	
Frequency tolerance (*6)		915.0	ppm	-0.15	±20 (*4)

(\*1) FCC 47 CFR Part15, Subpart C, Section 15.247

(\*2) Since 6dB Bandwidth is less than 500kHz, Digital modulation system is not applied.

Since 20dB Bandwidth is less than 250kHz, Frequency hopping system is applied.

(\*3) IEEE.802.15.4-2020

M1:  $1.5 \cdot R \cdot (h+1)$ , M2:  $3 \cdot R \cdot (h+1)$ , R(symbol rate): 50kbps, h(modulation index): 1

(\*4) Wi-SUN PHY Technical Specification - Amendment 1VA9 (11 Nov 2022). (\*5) IEEE.802.15.4-2020

(\*6) This characteristic depends on TCXO.

**Table 6 TX Radio Regulations characteristics (2/2)**

Items		RF Frequency [MHz]	Unit	Evaluation results	Spec
Unwanted emissions	30 - 88MHz	902.2	dBm /100kHz	-62.2	-55.2 (*1)
		915.0		-63.6	
		927.8		-63.5	
	88 - 216MHz	902.2	dBm /100kHz	-59.3	-51.7 (*1)
		915.0		-59.4	
		927.8		-60.0	
	216 - 614MHz	902.2	dBm /100kHz	-58.7	-49.2 (*1)
		915.0		-58.8	
		927.8		-59.4	
	960 - 1722.2MHz	902.2	dBm /MHz	-47.5	-41.2 (*1)
		915.0		-46.6	
		927.8		-47.0	
	2200 - 5460MHz	902.2	dBm /MHz	-47.4	-41.2 (*1)
		915.0		-48.0	
		927.8		-47.8	
	7250 - 9200MHz	902.2	dBm /MHz	-51.4	-41.2 (*1)
		915.0		-51.8	
		927.8		-51.8	
Tx out of band emission (Band edge)	Lower 870 - 902MHz	902.2	dBc	-47.8	-20 (*2)
		915.0		-78.3	
		927.8		-79.7	
	Upper 928 - 960MHz	902.2	dBc	-79.8	-20 (*2)
		915.0		-79.4	
		927.8		-47.8	

(\*1) In the FCC standard, spurious emissions are specified by electric field intensity (V / m). Since this document is the result of the wired condition, the value converted to the power value (dBm) is used.

Power (dBm)@3m =  $10 \cdot \log(300E^2)$ , E = electric field intensity (V / m)

(\*2) FCC 47 CFR Part15, Subpart C, Section 15.247



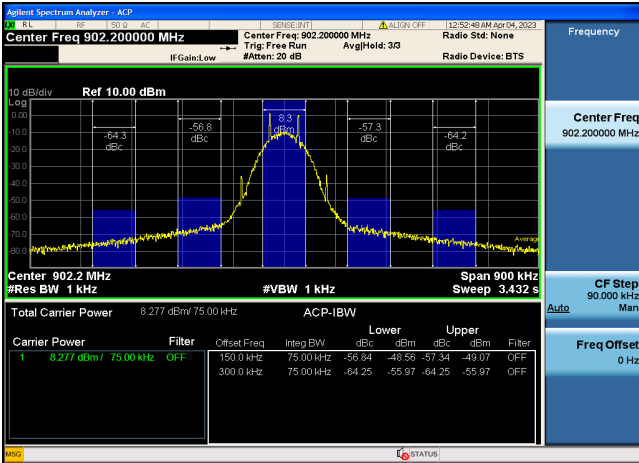


Figure 7 Transmit Spectrum (Frequency = 902.2MHz)

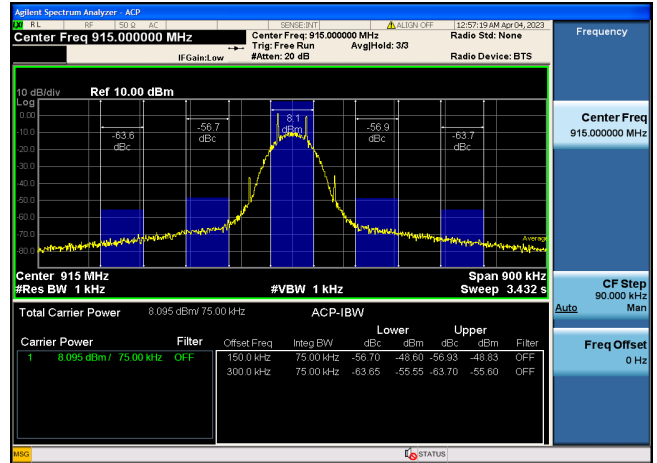


Figure 8 Transmit Spectrum (Frequency = 915.0MHz)

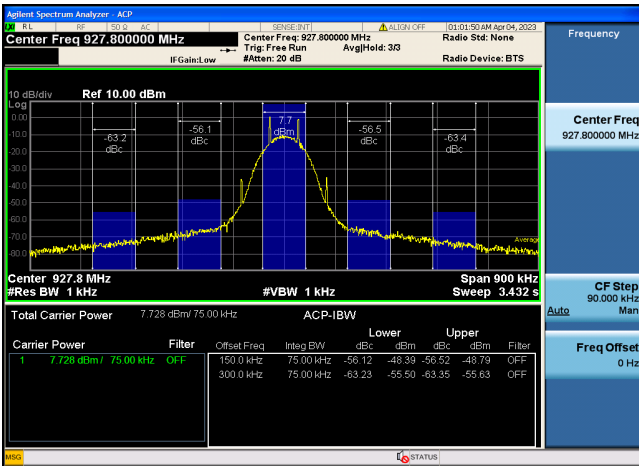


Figure 9 Transmit Spectrum (Frequency = 927.8MHz)

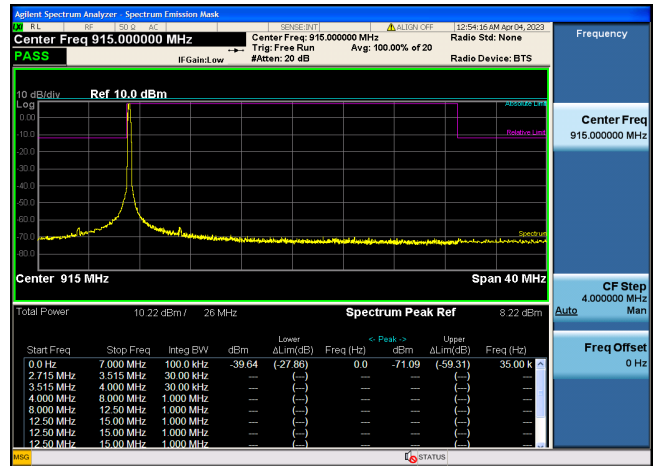


Figure 10 TX Out of Band Emissions for Operational Frequency Band (Frequency = 902.2MHz)

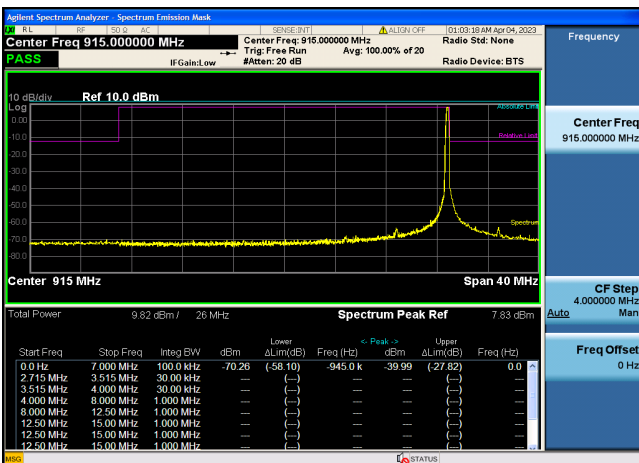


Figure 11 TX Out of Band Emissions for Operational Frequency Band (Frequency = 927.8MHz)

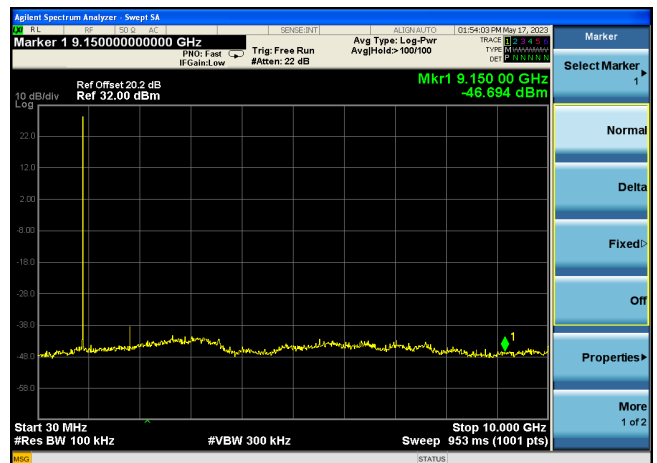


Figure 12 TX Spurious emission (Frequency = 915.0MHz)

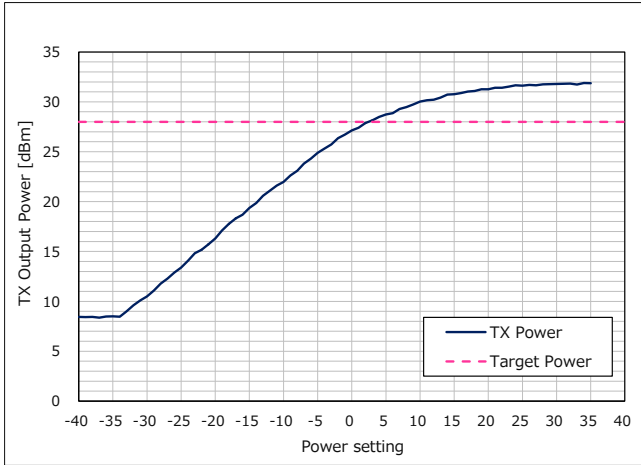
**2.2.2 FSK (150kbps, modulation index = 0.5)**

**(1) TX Power sweep characteristics**

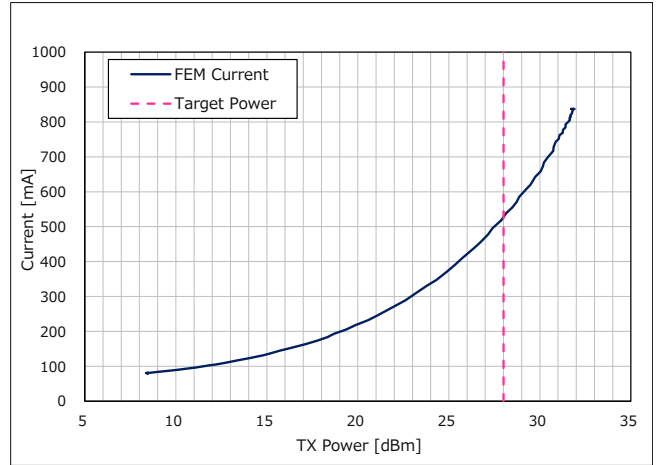
Signal condition: Frequency = 915.2MHz

**Table 7 TX Power sweep characteristics**

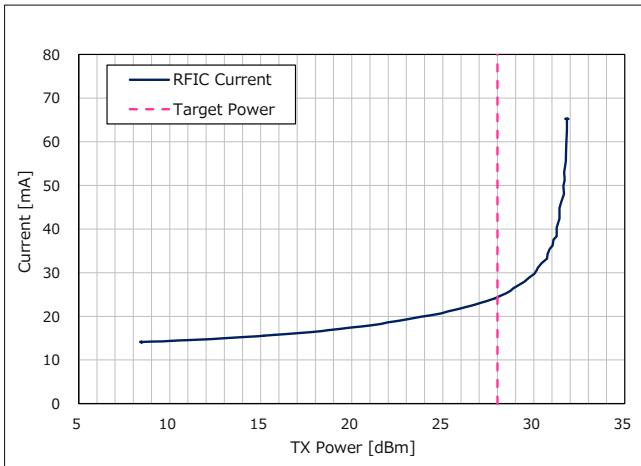
Items		Unit	Evaluation results
TX Power Range	Max	dBm	31.9
	Min		8.4
	Variable power range	dB	23.5
Current Range	V <sub>FEM</sub>	Max	837.0
		Min	80.9
	V <sub>RFIC</sub>	Max	65.3
		Min	14.1



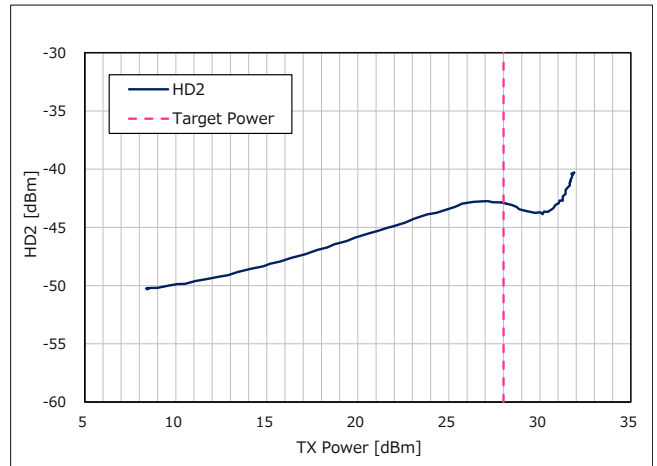
**Figure 13 Power Setting vs. TX Power (Frequency = 915.2MHz)**



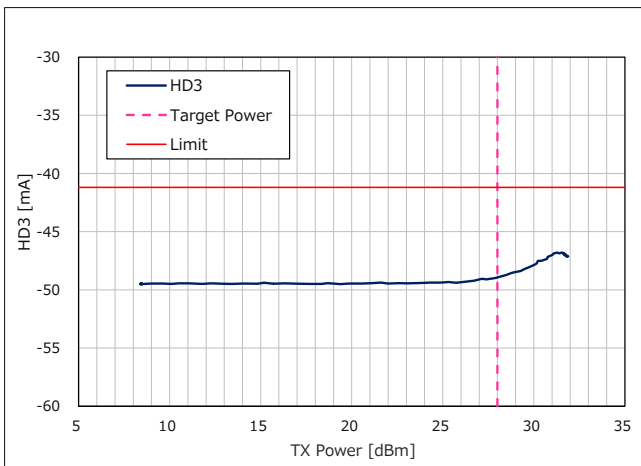
**Figure 14 TX Power vs. Current of  $V_{FEM}$  for TX mode (Frequency = 915.2MHz)**



**Figure 15 TX Power vs. Current of  $V_{RFIC}$  for TX mode (Frequency = 915.2MHz)**



**Figure 16 TX Power vs. 2nd Harmonics (Frequency = 915.2MHz)**



**Figure 17 TX Power vs. 3rd Harmonics (Frequency = 915.2MHz)**

**(2) TX Radio Regulations characteristics**

Signal condition: Target TX Power = +28dBm

**Table 8 TX Radio Regulations characteristics (1/2)**

Items		RF Frequency [MHz]	Unit	Evaluation results	Spec
TX Power		902.2	dBm	28.56	+30.0 (*1)
		915.2		28.28	
		927.8		28.06	
Harmonics	2nd	902.2	dBm /MHz	-44.1	-
		915.2		-43.2	
		927.8		-42.8	
	3rd	902.2		-48.2	-41.2 (*1)
		915.2		-48.8	
		927.8		-48.6	
Occupied Bandwidth		902.4	kHz	159.7	-
		915.2		163.2	
		927.6		161.5	
6dB Bandwidth (*2)		902.4	kHz	95.5	-
		915.2		95.7	
		927.6		95.3	
20dB Bandwidth (*2)		902.4	kHz	185.4	-
		915.2		187.3	
		927.6		187.4	
Adjacent Channel Power Ratio (M1_Lower, 337.5 kHz offset) (*3)		902.4	dBc	-55.2	-25 (*5)
		915.2		-55.0	
		927.6		-54.9	
Adjacent Channel Power Ratio (M1_Upper, 337.5 kHz offset) (*3)		902.4	dBc	-55.2	-25 (*5)
		915.2		-54.9	
		927.6		-54.9	
Adjacent Channel Power Ratio (M2_Lower, 675 kHz offset) (*3)		902.4	dBc	-64.3	-35 (*5)
		915.2		-64.0	
		927.6		-63.6	
Adjacent Channel Power Ratio (M2_Upper, 675 kHz offset) (*3)		902.4	dBc	-64.5	-35 (*5)
		915.2		-63.8	
		927.6		-63.8	
Deviation Offset		902.4	% rms	5.4	30 (*4)
		915.2		5.1	
		927.6		5.0	
Zero Crossing Error		902.4	% pk	-2.1	±12.5 (*4)
		915.2		2.5	
		927.6		2.3	
Frequency tolerance (*6)		915.2	ppm	-0.15	±20 (*4)

(\*1) FCC 47 CFR Part15, Subpart C, Section 15.247

(\*2) Since 6dB Bandwidth is less than 500kHz, Digital modulation system is not applied.

Since 20dB Bandwidth is less than 250kHz, Frequency hopping system is applied.

(\*3) IEEE.802.15.4-2020

M1:  $1.5 \cdot R \cdot (h+1)$ , M2:  $3 \cdot R \cdot (h+1)$ , R(symbol rate): 150kbps, h(modulation index): 0.5

(\*4) Wi-SUN PHY Technical Specification - Amendment 1VA9 (11 Nov 2022). (\*5) IEEE.802.15.4-2020

(\*6) This characteristic depends on TCXO.

**Table 9 TX Radio Regulations characteristics (2/2)**

Items		RF Frequency [MHz]	Unit	Evaluation results	Spec
Unwanted emissions	30 - 88MHz	902.4	dBm /100kHz	-63.2	-55.2 (*1)
		915.2		-63.1	
		927.6		-63.2	
	88 - 216MHz	902.4	dBm /100kHz	-59.9	-51.7 (*1)
		915.2		-60.3	
		927.6		-59.5	
	216 - 614MHz	902.4	dBm /100kHz	-59.4	-49.2 (*1)
		915.2		-59.5	
		927.6		-60.5	
	960 - 1722.2MHz	902.4	dBm /MHz	-48.0	-41.2 (*1)
		915.2		-47.9	
		927.6		-48.4	
	2200 - 5460MHz	902.4	dBm /MHz	-48.2	-41.2 (*1)
		915.2		-48.8	
		927.6		-48.6	
	7250 - 9200MHz	902.4	dBm /MHz	-52.0	-41.2 (*1)
		915.2		-51.8	
		927.6		-51.5	
Tx out of band emission (Band edge)	Lower 870 - 902MHz	902.4	dBc	-51.9	-20 (*2)
		915.2		-77.4	
		927.6		-78.0	
	Upper 928 - 960MHz	902.4	dBc	-79.3	-20 (*2)
		915.2		-77.1	
		927.6		-50.9	

(\*1) In the FCC standard, spurious emissions are specified by electric field intensity (V / m). Since this document is the result of the wired condition, the value converted to the power value (dBm) is used.

Power (dBm)@3m =  $10 \cdot \log(300E^2)$ , E = electric field intensity (V / m)

(\*2) FCC 47 CFR Part15, Subpart C, Section 15.247

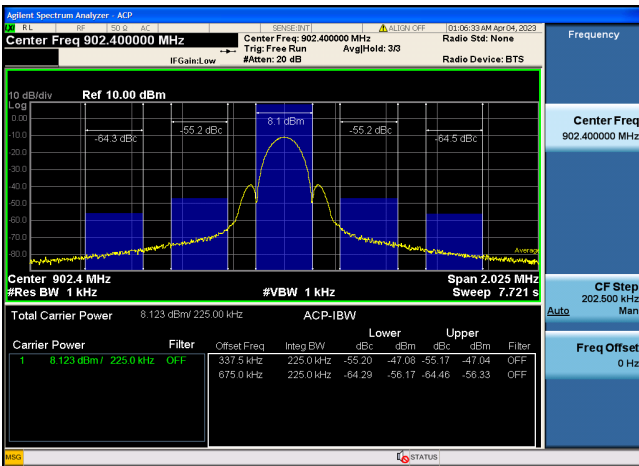


Figure 18 Transmit Spectrum (Frequency = 902.4MHz)

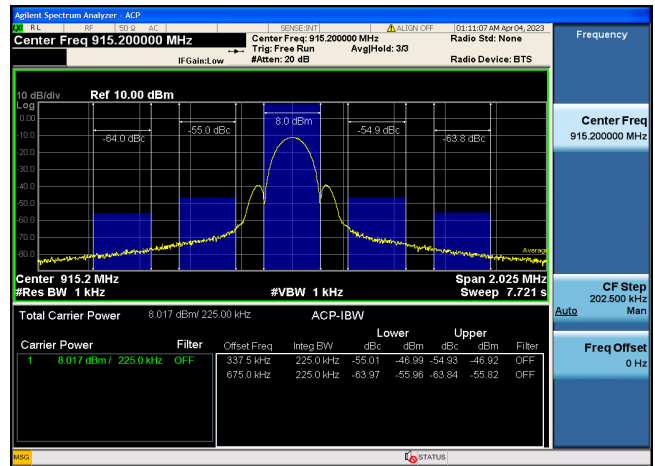


Figure 19 Transmit Spectrum (Frequency = 915.2MHz)

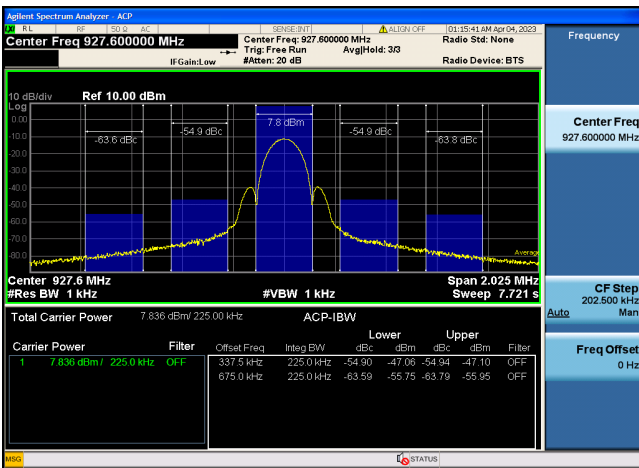


Figure 20 Transmit Spectrum (Frequency = 927.6MHz)

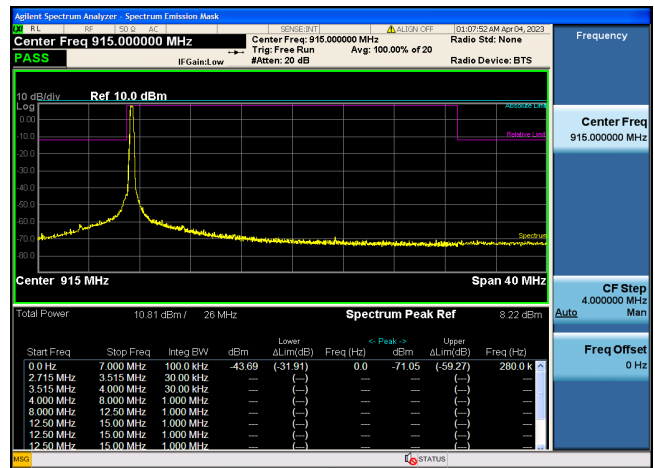


Figure 21 TX Out of Band Emissions for Operational Frequency Band (Frequency = 902.4MHz)

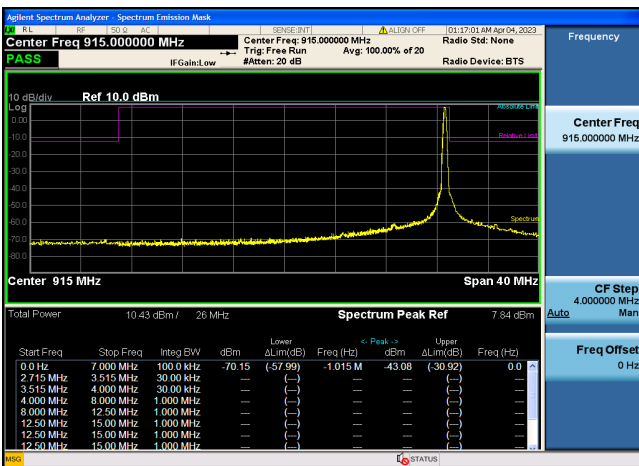


Figure 22 TX Out of Band Emissions for Operational Frequency Band (Frequency = 927.6MHz)



Figure 23 TX Spurious emission (Frequency = 915.2MHz)

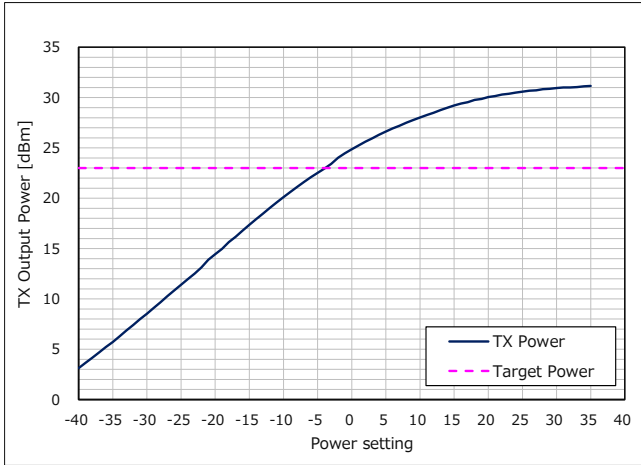
**2.2.3 OFDM (Option1, MCS6)**

**(1) TX Power sweep characteristics**

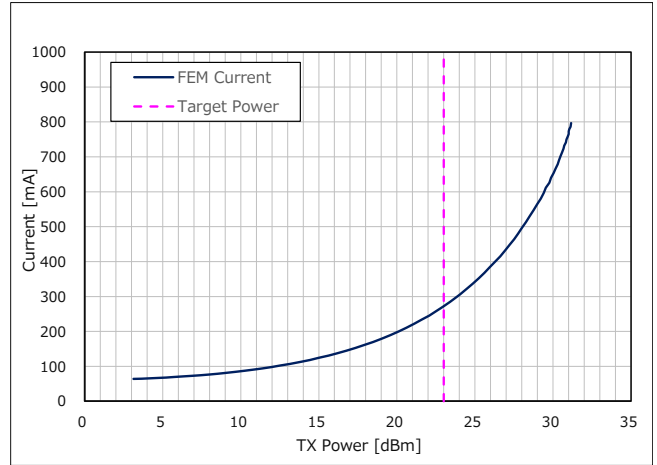
Signal condition: Frequency = 915.2MHz

**Table 10 TX Power sweep characteristics**

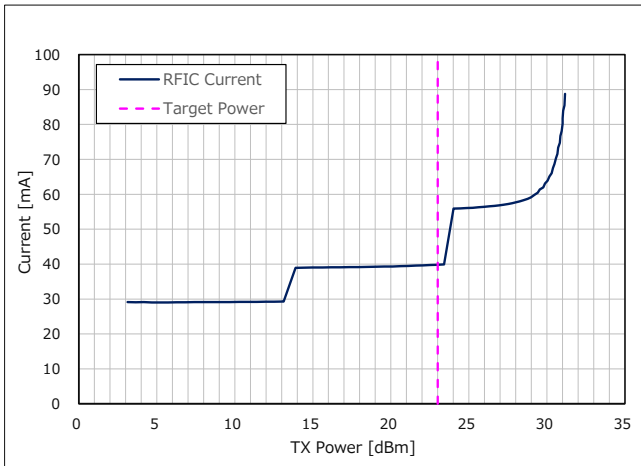
Items		Unit	Evaluation results
TX Power Range	Max	dBm	31.2
	Min		3.1
	Variable power range	dB	28.1
Current Range	V <sub>FEM</sub>	Max	796.7
		Min	64.0
	V <sub>RFIC</sub>	Max	88.8
		Min	29.1



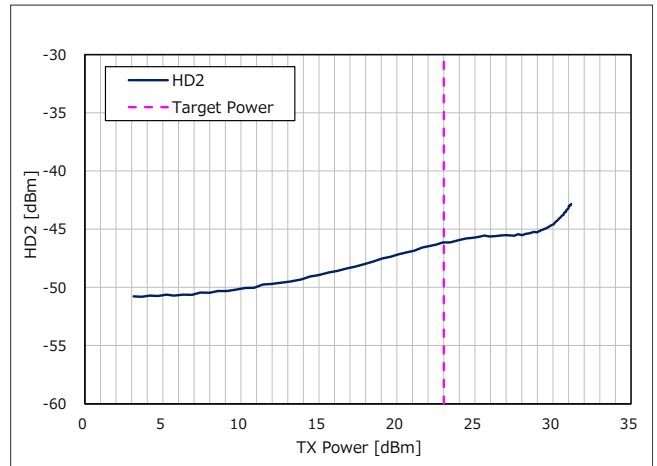
**Figure 24 Power Setting vs. TX Power (Frequency = 915.2MHz)**



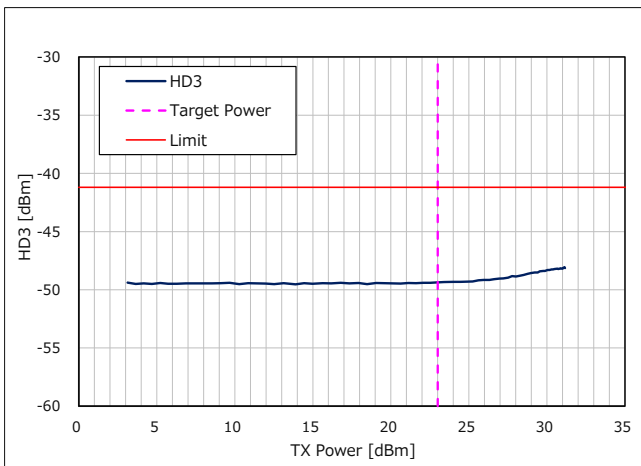
**Figure 25 TX Power vs. Current of  $V_{FEM}$  for TX mode (Frequency = 915.2MHz)**



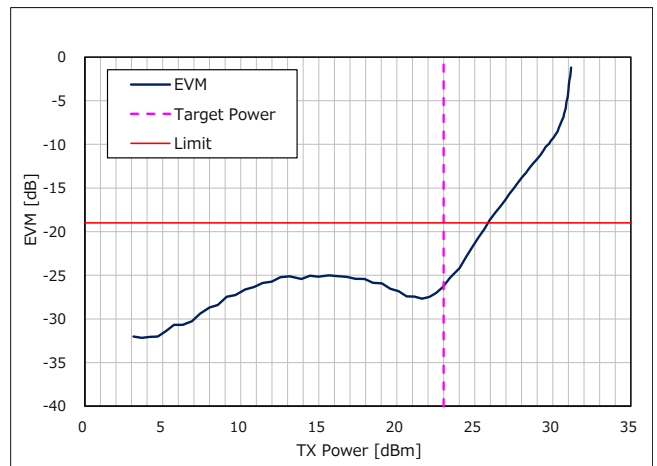
**Figure 26 TX Power vs. Current of  $V_{RFIC}$  for TX mode (Frequency = 915.2MHz)**



**Figure 27 TX Power vs. 2nd Harmonics (Frequency = 915.2MHz)**



**Figure 28 TX Power vs. 3rd Harmonics (Frequency = 915.2MHz)**



**Figure 29 TX Power vs. EVM (Frequency = 915.2MHz)**



**(2) TX Radio Regulations characteristics**

Signal condition: Target TX Power = +23dBm

**Table 11 TX Radio Regulations characteristics (1/2)**

Items		RF Frequency [MHz]	Unit	Evaluation results	Spec
TX Power		903.2	dBm	23.7	+30.0 (*1)
		915.2		23.1	
		927.2		23.3	
Harmonics	2nd	903.2	dBm /MHz	-46.2	-
		915.2		-46.2	
		927.2		-46.4	
	3rd	903.2		-49.0	-41.2 (*1)
		915.2		-49.4	
		927.2		-49.2	
Occupied Bandwidth		903.2	kHz	1088.9	-
		915.2		1092.5	
		927.2		1090.9	
6dB Bandwidth (*2)		903.2	kHz	1100.7	-
		915.2		1093.2	
		927.2		1092.4	
20dB Bandwidth (*2)		903.2	kHz	1155.5	-
		915.2		1152.2	
		927.2		1153.4	
Adjacent Channel Power Ratio	Lower	903.2	dBc	-32.5	-20 (*3)
		915.2		-33.2	
		927.2		-33.2	
	Upper	903.2		-32.8	
		915.2		-33.7	
		927.2		-33.5	
Alternate Channel Power Ratio	Lower	903.2	dBc	-48.8	-40 (*3)
		915.2		-49.4	
		927.2		-48.9	
	Upper	903.2		-49.0	
		915.2		-49.7	
		927.2		-49.6	
Modulation quality	EVM	903.2	dB	-24.9	-19 (*4)
		915.2		-26.2	
		927.2		-26.9	

(\*1) FCC 47 CFR Part15, Subpart C, Section 15.247

(\*2) Since 6dB Bandwidth is more than 500kHz, Digital modulation system is applied.

Since 20dB Bandwidth is more than 500kHz, Frequency hopping system is not applied.

(\*3) Wi-SUN PHY Technical Specification - Amendment 1VA9 (11 Nov 2022)

(\*4) IEEE.802.15.4-2020

**Table 12 TX Radio Regulations characteristics (2/2)**

Items		RF Frequency [MHz]	Unit	Evaluation results	Spec
Unwanted emissions	30 - 88MHz	903.2	dBm /100kHz	-65.1	-55.2 (*1)
		915.2		-65.0	
		927.2		-64.7	
	88 - 216MHz	903.2	dBm /100kHz	-60.1	-51.7 (*1)
		915.2		-60.5	
		927.2		-60.9	
	216 - 614MHz	903.2	dBm /100kHz	-61.7	-49.2 (*1)
		915.2		-62.4	
		927.2		-63.5	
	960 - 1722.2MHz	903.2	dBm /MHz	-47.8	-41.2 (*1)
		915.2		-49.6	
		927.2		-49.1	
	2200 - 5460MHz	903.2	dBm /MHz	-49.0	-41.2 (*1)
		915.2		-49.4	
		927.2		-49.2	
7250 - 9200MHz	903.2	dBm /MHz	-52.3	-41.2 (*1)	
	915.2		-51.3		
	927.2		-51.0		
Tx out of band emission (Band edge)	Lower 870 - 902MHz	903.2	dBc	-30.3	-20 (*2)
		915.2		-66.7	
		927.2		-68.0	
	Upper 928 - 960MHz	903.2	dBc	-67.8	-20 (*2)
		915.2		-66.4	
		927.2		-28.2	

(\*1) In the FCC standard, spurious emissions are specified by electric field intensity (V / m). Since this document is the result of the wired condition, the value converted to the power value (dBm) is used.

Power (dBm)@3m =  $10 \cdot \log(300E^2)$ , E = electric field intensity (V / m)

(\*2) FCC 47 CFR Part15, Subpart C, Section 15.247

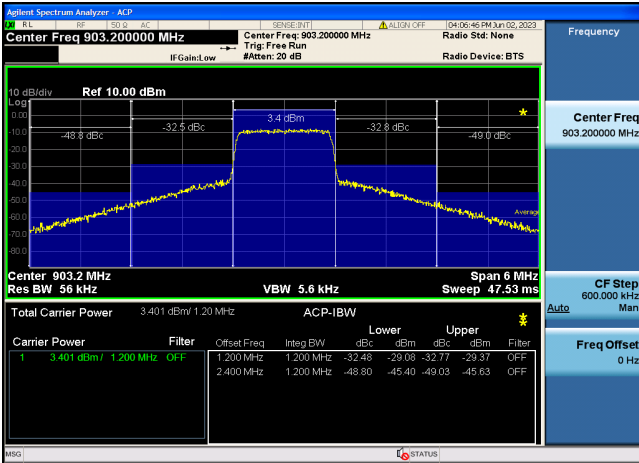


Figure 30 Transmit Spectrum (Frequency = 903.2MHz)

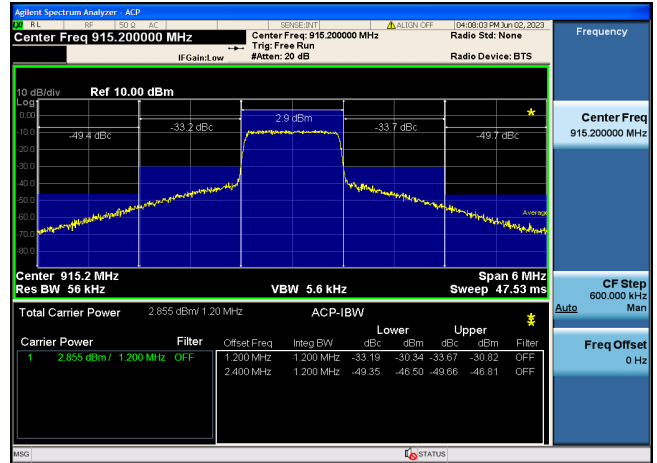


Figure 31 Transmit Spectrum (Frequency = 915.2MHz)

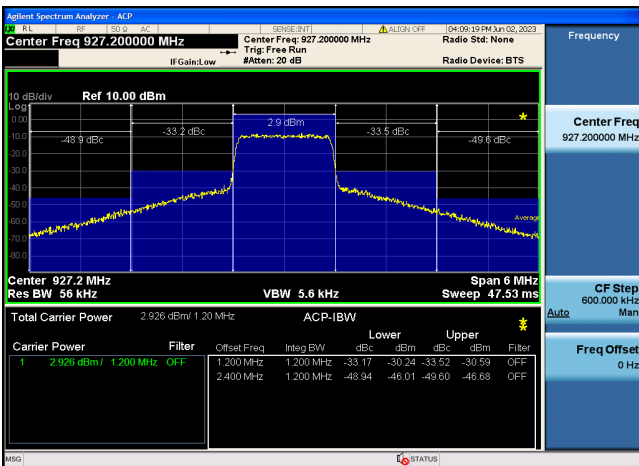


Figure 32 Transmit Spectrum (Frequency = 927.2MHz)

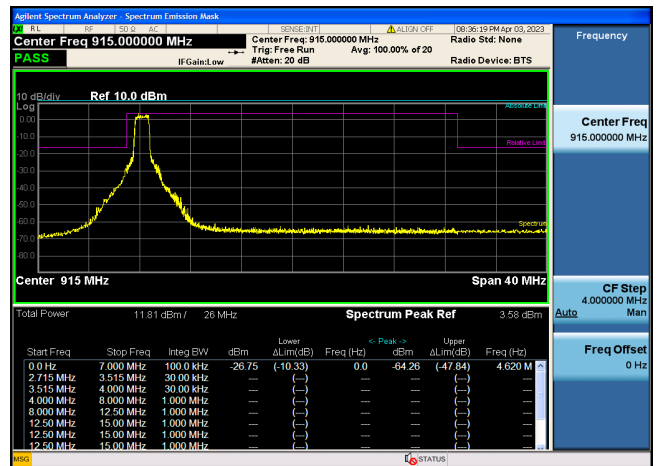


Figure 33 TX Out of Band Emissions for Operational Frequency Band (Frequency = 903.2MHz)

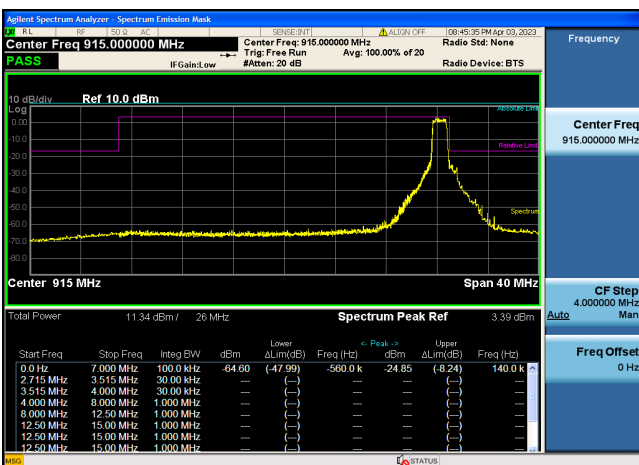


Figure 34 TX Out of Band Emissions for Operational Frequency Band (Frequency = 927.2MHz)

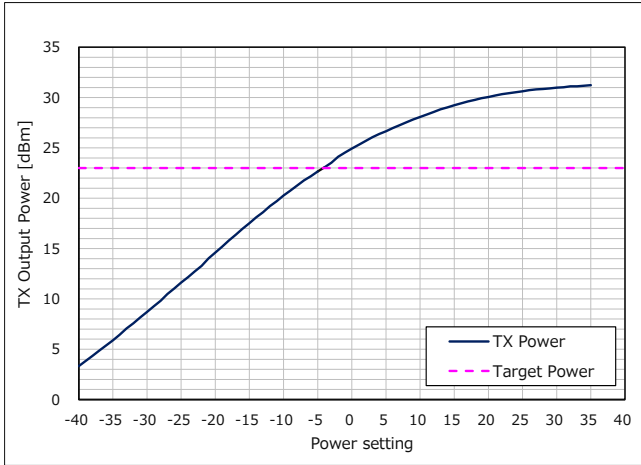
**2.2.4 OFDM (Option2, MCS6)**

**(1) TX Power sweep characteristics**

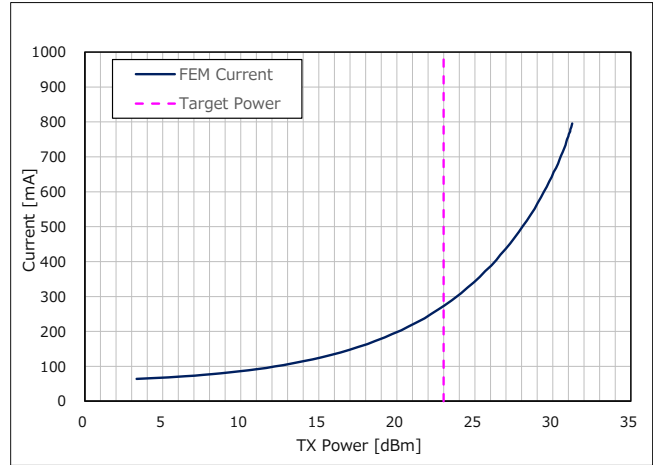
Signal condition: Frequency = 914.8MHz

**Table 13 TX Power sweep characteristics**

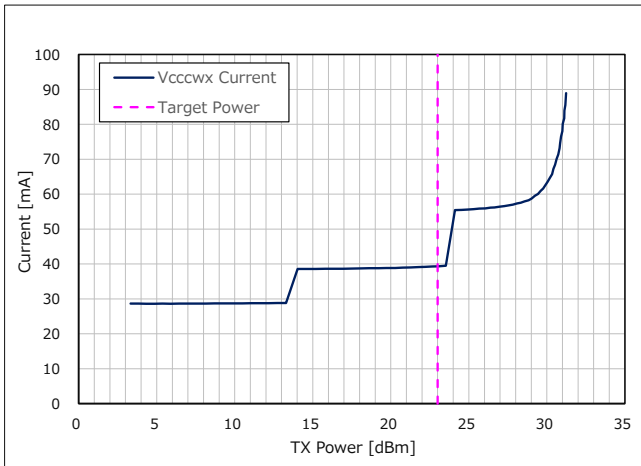
Items		Unit	Evaluation results
TX Power Range	Max	dBm	31.2
	Min		3.3
	Variable power range	dB	27.9
Current Range	V <sub>FEM</sub>	Max	795.5
		Min	64.3
	V <sub>RFIC</sub>	Max	88.9
		Min	28.7



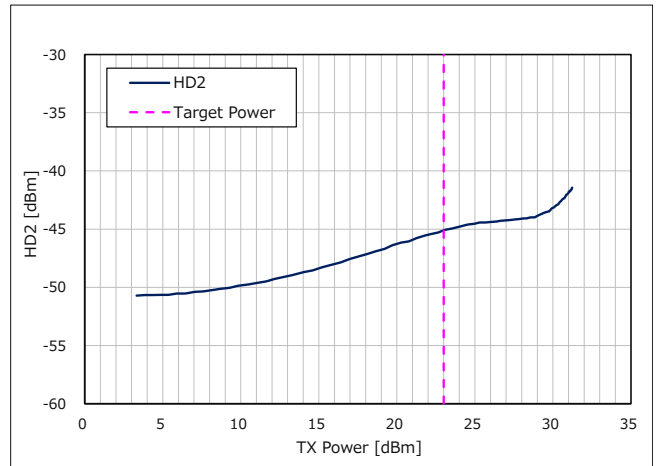
**Figure 35 Power Setting vs. TX Power (Frequency = 914.8MHz)**



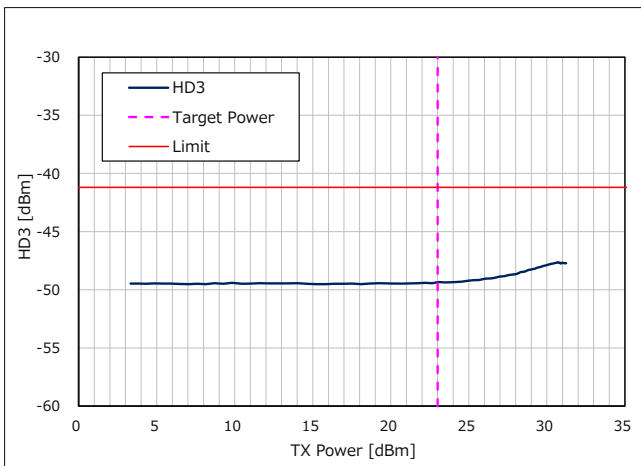
**Figure 36 TX Power vs. Current of  $V_{FEM}$  for TX mode (Frequency = 914.8MHz)**



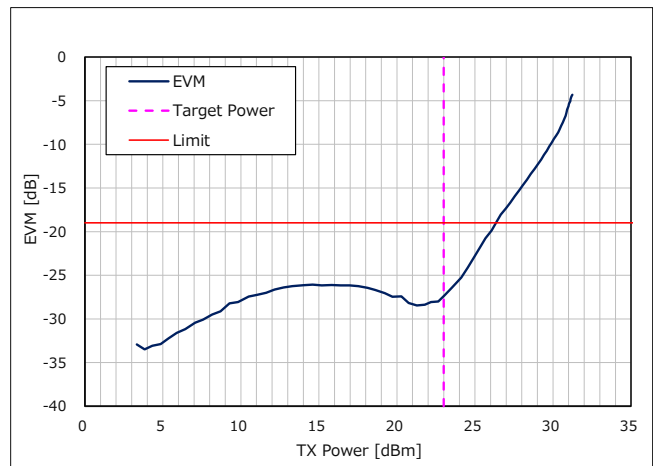
**Figure 37 TX Power vs. Current of  $V_{RFIC}$  for TX mode (Frequency = 914.8MHz)**



**Figure 38 TX Power vs. 2nd Harmonics (Frequency = 914.8MHz)**



**Figure 39 TX Power vs. 3rd Harmonics (Frequency = 914.8MHz)**



**Figure 40 TX Power vs. EVM (Frequency = 914.8MHz)**

**(2) TX Radio Regulations characteristics**

Signal condition: Target TX Power = +23dBm

**Table 14 TX Radio Regulations characteristics (1/2)**

Items		RF Frequency [MHz]	Unit	Evaluation results	Spec
TX Power		902.8	dBm	23.6	+30.0 (*1)
		914.8		23.2	
		927.6		23.3	
Harmonics	2nd	902.8	dBm /MHz	-45.0	-
		914.8		-45.1	
		927.6		-45.4	
	3rd	902.8		-49.0	-41.2 (*1)
		914.8		-49.4	
		927.6		-49.1	
Occupied Bandwidth		902.8	kHz	558.1	-
		914.8		556.2	
		927.6		555.5	
6dB Bandwidth (*2)		902.8	kHz	555.4	-
		914.8		551.8	
		927.6		552.8	
20dB Bandwidth (*2)		902.8	kHz	605.4	-
		914.8		603.7	
		927.6		609.4	
Adjacent Channel Power Ratio	Lower	902.8	dBc	-34.5	-20 (*3)
		914.8		-35.6	
		927.6		-35.8	
	Upper	902.8		-34.8	
		914.8		-35.5	
		927.6		-35.9	
Alternate Channel Power Ratio	Lower	902.8	dBc	-54.4	-40 (*3)
		914.8		-54.7	
		927.6		-54.6	
	Upper	902.8		-54.8	
		914.8		-55.0	
		927.6		-55.2	
Modulation quality	EVM	902.8	dB	-25.0	-19 (*4)
		914.8		-27.1	
		927.6		-27.5	

(\*1) FCC 47 CFR Part15, Subpart C, Section 15.247

(\*2) Since 6dB Bandwidth is more than 500kHz, Digital modulation system is applied.

Since 20dB Bandwidth is more than 500kHz, Frequency hopping system is not applied.

(\*3) Wi-SUN PHY Technical Specification - Amendment 1VA9 (11 Nov 2022)

(\*4) IEEE.802.15.4-2020

**Table 15 TX Power sweep characteristics (2/2)**

Items		RF Frequency [MHz]	Unit	Evaluation results	Spec
Unwanted emissions	30 - 88MHz	902.8	dBm /100kHz	-65.4	-55.2 (*1)
		914.8		-64.9	
		927.6		-62.8	
	88 - 216MHz	902.8	dBm /100kHz	-60.9	-51.7 (*1)
		914.8		-61.1	
		927.6		-60.2	
	216 - 614MHz	902.8	dBm /100kHz	-62.3	-49.2 (*1)
		914.8		-61.9	
		927.6		-62.8	
	960 - 1722.2MHz	902.8	dBm /MHz	-48.8	-41.2 (*1)
		914.8		-49.2	
		927.6		-49.2	
	2200 - 5460MHz	902.8	dBm /MHz	-49.0	-41.2 (*1)
		914.8		-49.4	
		927.6		-49.1	
7250 - 9200MHz	902.8	dBm /MHz	-51.4	-41.2 (*1)	
	914.8		-51.2		
	927.6		-51.1		
Tx out of band emission (Band edge)	Lower 870 - 902MHz	902.8	dBc	-37.0	-20 (*2)
		914.8		-68.9	
		927.6		-69.5	
	Upper 928 - 960MHz	902.8	dBc	-68.8	-20 (*2)
		914.8		-68.1	
		927.6		-23.0	

(\*1) In the FCC standard, spurious emissions are specified by electric field intensity (V / m). Since this document is the result of the wired condition, the value converted to the power value (dBm) is used.

Power (dBm)@3m =  $10 \cdot \log(300E^2)$ , E = electric field intensity (V / m)

(\*2) FCC 47 CFR Part15, Subpart C, Section 15.247

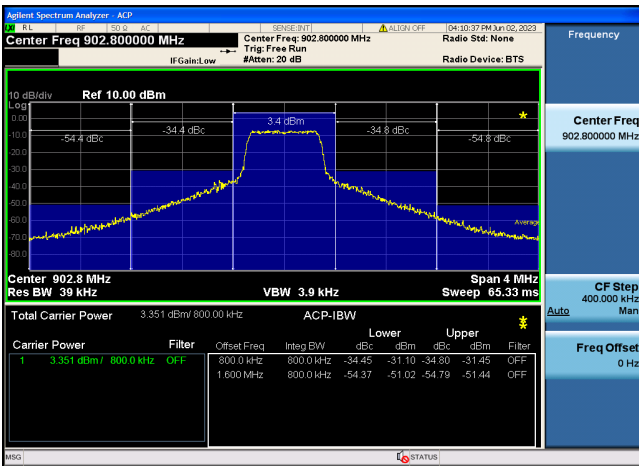


Figure 41 Transmit Spectrum (Frequency = 902.8MHz)

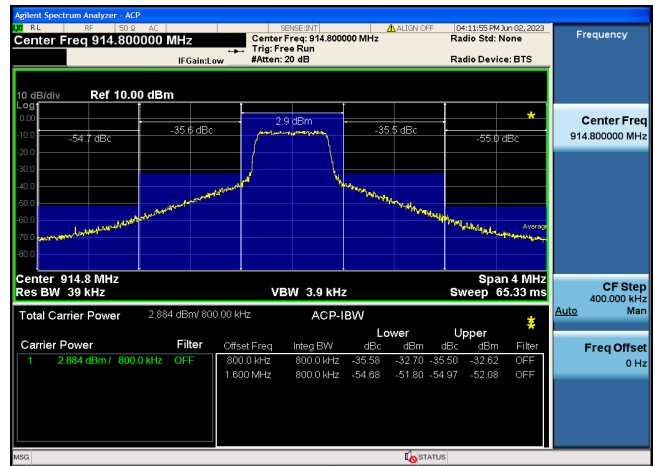


Figure 42 Transmit Spectrum (Frequency = 914.8MHz)

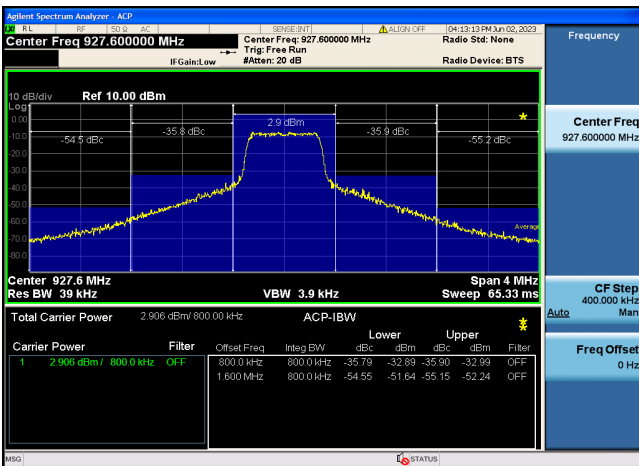


Figure 43 Transmit Spectrum (Frequency = 927.6MHz)

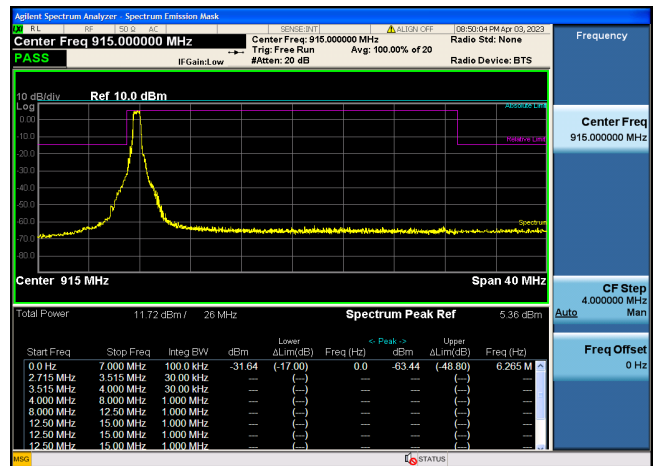


Figure 44 TX Out of Band Emissions for Operational Frequency Band (Frequency = 902.8MHz)

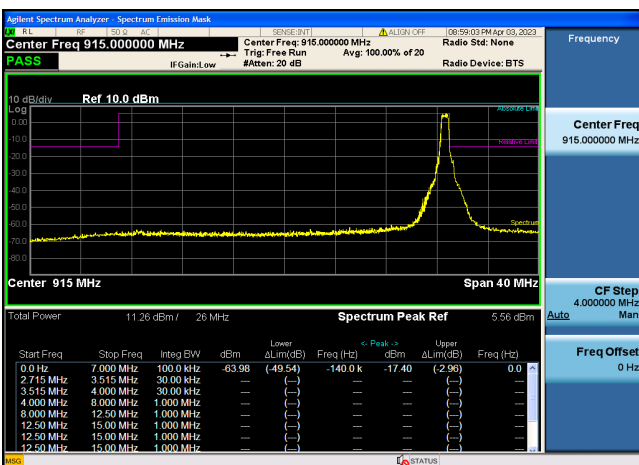


Figure 45 TX Out of Band Emissions for Operational Frequency Band (Frequency = 927.6MHz)



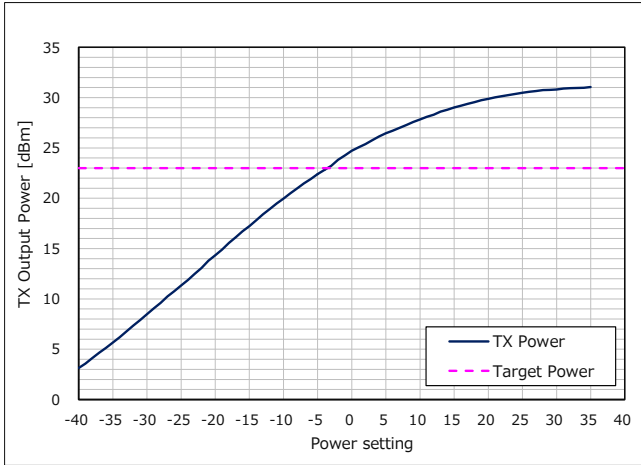
**2.2.5 OFDM (Option3, MCS6)**

**(1) TX Power sweep characteristics**

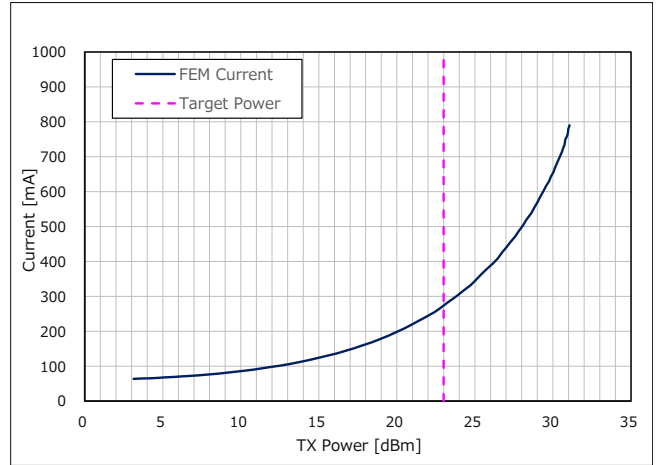
Signal condition: Frequency = 915.2MHz

**Table 16 TX Power sweep characteristics**

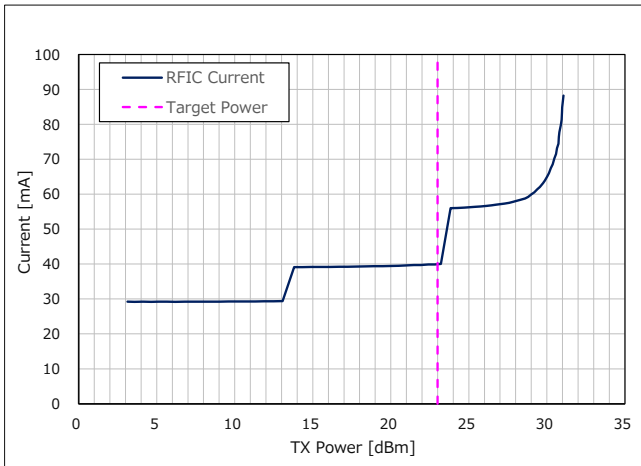
Items		Unit	Evaluation results
TX Power Range	Max	dBm	31.1
	Min		3.1
	Variable power range	dB	28.0
Current Range	V <sub>FEM</sub>	Max	789.9
		Min	63.9
	V <sub>RFIC</sub>	Max	88.2
		Min	29.2



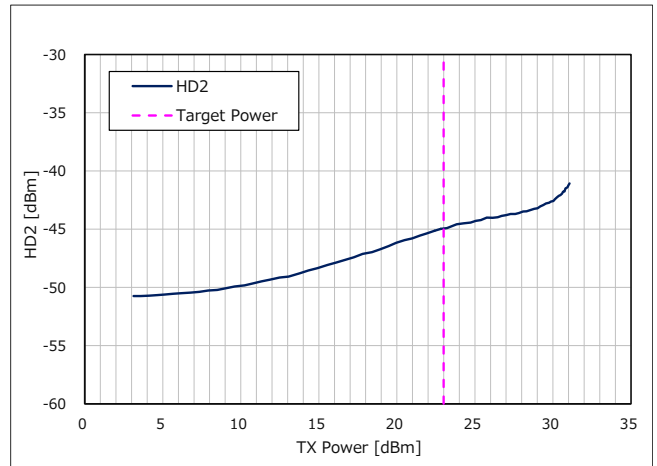
**Figure 46 Power Setting vs. TX Power (Frequency = 915.2MHz)**



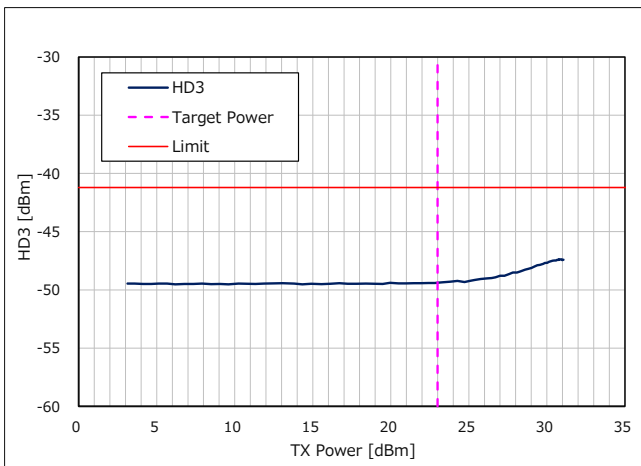
**Figure 47 TX Power vs. Current of  $V_{FEM}$  for TX mode (Frequency = 915.2MHz)**



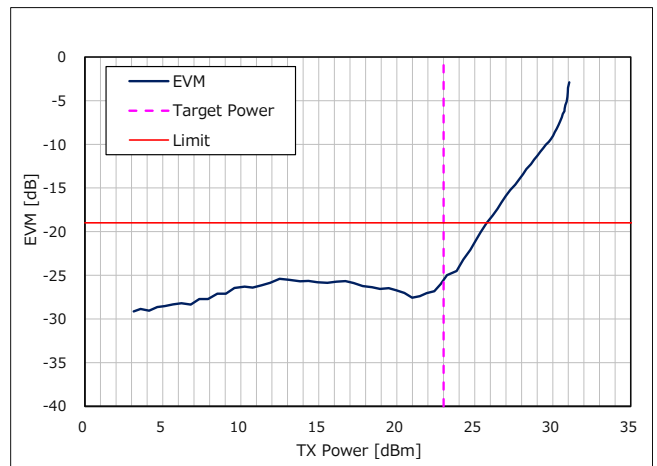
**Figure 48 TX Power vs. Current of  $V_{RFIC}$  for TX mode (Frequency = 915.2MHz)**



**Figure 49 TX Power vs. 2nd Harmonics (Frequency = 915.2MHz)**



**Figure 50 TX Power vs. 3rd Harmonics (Frequency = 915.2MHz)**



**Figure 51 TX Power vs. EVM (Frequency = 915.2MHz)**

**(2) TX Radio Regulations characteristics**

Signal condition: Target TX Power = +23dBm

**Table 17 TX Radio Regulations characteristics (1/2)**

Items		RF Frequency [MHz]	Unit	Evaluation results	Spec
TX Power		902.4	dBm	23.4	+30.0 (*1)
		915.2		23.0	
		927.6		23.0	
Harmonics	2nd	902.4	dBm /MHz	-44.9	-
		915.2		-45.0	
		927.6		-45.3	
	3rd	902.4		-48.9	-41.2 (*1)
		915.2		-49.4	
		927.6		-49.2	
Occupied Bandwidth		902.4	kHz	285.0	-
		915.2		284.5	
		927.6		284.0	
6dB Bandwidth (*2)		902.4	kHz	282.4	-
		915.2		281.8	
		927.6		281.7	
20dB Bandwidth (*2)		902.4	kHz	321.1	-
		915.2		319.6	
		927.6		320.2	
Adjacent Channel Power Ratio	Lower	902.4	dBc	-33.4	-20 (*3)
		915.2		-34.7	
		927.6		-34.9	
	Upper	902.4		-33.1	
		915.2		-34.3	
		927.6		-34.8	
Alternate Channel Power Ratio	Lower	902.4	dBc	-53.6	-40 (*3)
		915.2		-53.8	
		927.6		-53.9	
	Upper	902.4		-53.7	
		915.2		-54.5	
		927.6		-54.2	
Modulation quality	EVM	902.4	dB	-23.4	-19 (*4)
		915.2		-25.8	
		927.6		-26.0	

(\*1) FCC 47 CFR Part15, Subpart C, Section 15.247

(\*2) Since 6dB Bandwidth is less than 500kHz, Digital modulation system is not applied.

Since 20dB Bandwidth is less than 500kHz, Frequency hopping system is applied.

(\*3) Wi-SUN PHY Technical Specification - Amendment 1VA9 (11 Nov 2022)

(\*4) IEEE.802.15.4-2020

**Table 18 TX Radio Regulations characteristics (2/2)**

Items		RF Frequency [MHz]	Unit	Evaluation results	Spec
Unwanted emissions	30 - 88MHz	902.4	dBm /100kHz	-64.8	-55.2 (*1)
		915.2		-65.2	
		927.6		-65.0	
	88 - 216MHz	902.4	dBm /100kHz	-60.0	-51.7 (*1)
		915.2		-60.2	
		927.6		-60.1	
	216 - 614MHz	902.4	dBm /100kHz	-61.8	-49.2 (*1)
		915.2		-61.5	
		927.6		-62.8	
	960 - 1722.2MHz	902.4	dBm /MHz	-48.3	-41.2 (*1)
		915.2		-49.7	
		927.6		-49.0	
	2200 - 5460MHz	902.4	dBm /MHz	-48.9	-41.2 (*1)
		915.2		-49.4	
		927.6		-49.2	
7250 - 9200MHz	902.4	dBm /MHz	-51.3	-41.2 (*1)	
	915.2		-51.7		
	927.6		-51.2		
Tx out of band emission (Band edge)	Lower 870 - 902MHz	902.4	dBc	-34.0	-20 (*2)
		915.2		-71.4	
		927.6		-71.9	
	Upper 928 - 960MHz	902.4	dBc	-71.6	-20 (*2)
		915.2		-70.5	
		927.6		-33.8	

(\*1) In the FCC standard, spurious emissions are specified by electric field intensity (V / m). Since this document is the result of the wired condition, the value converted to the power value (dBm) is used.

Power (dBm)@3m = 10\*log(300E<sup>2</sup>), E = electric field intensity (V / m)

(\*2) FCC 47 CFR Part15, Subpart C, Section 15.247

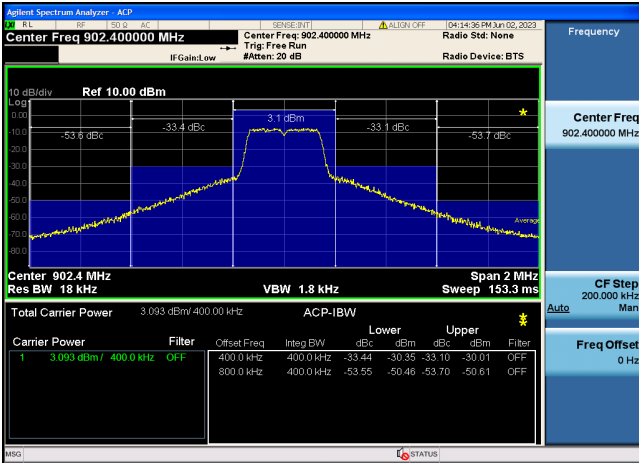


Figure 52 Transmit Spectrum (Frequency = 902.4MHz)

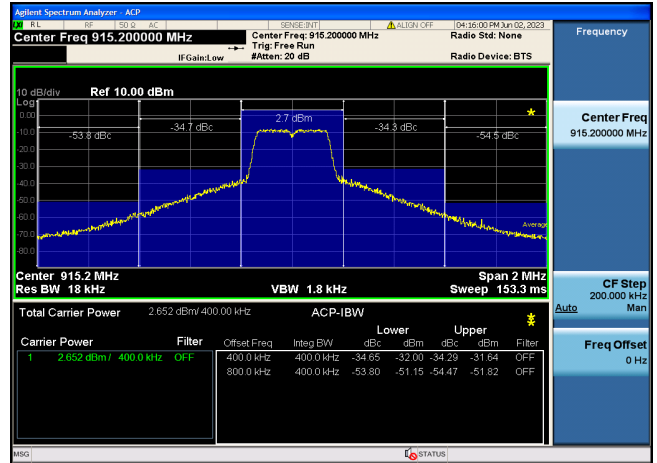


Figure 53 Transmit Spectrum (Frequency = 915.2MHz)

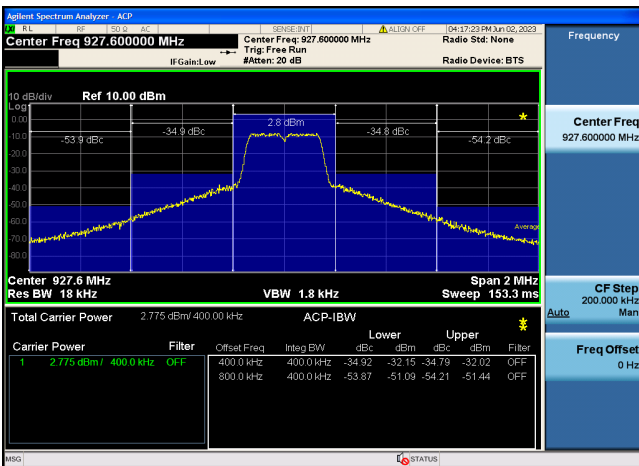


Figure 54 Transmit Spectrum (Frequency = 927.6MHz)

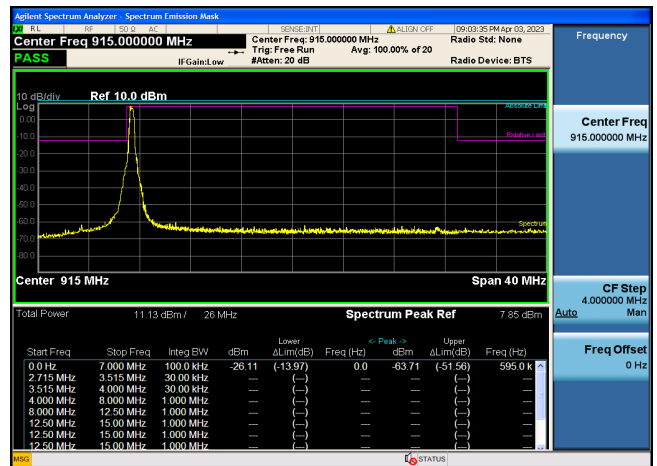


Figure 55 TX Out of Band Emissions for Operational Frequency Band (Frequency = 902.4MHz)

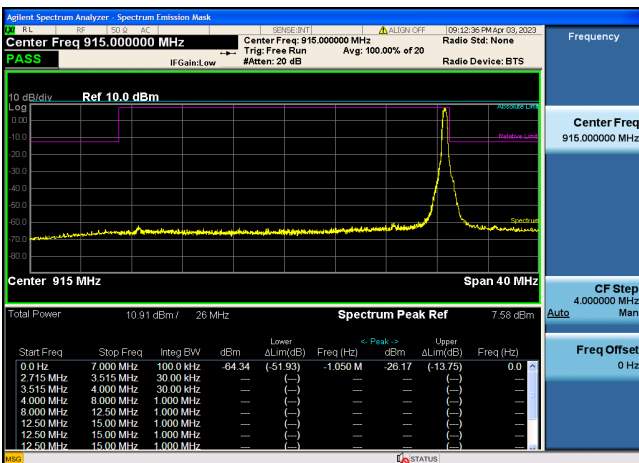


Figure 56 TX Out of Band Emissions for Operational Frequency Band (Frequency = 927.6MHz)

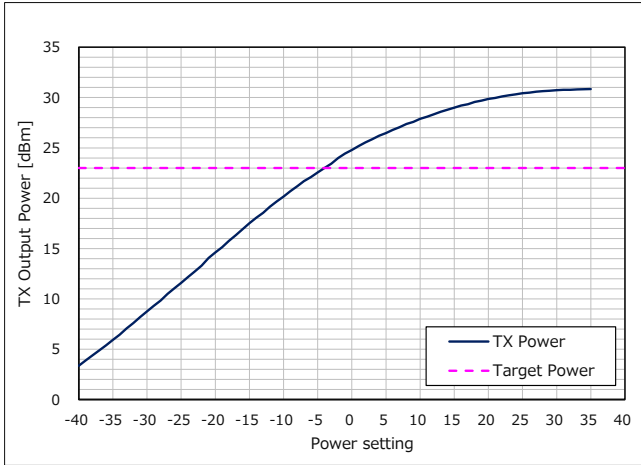
**2.2.6 OFDM (Option4, MCS6)**

**(1) TX Power sweep characteristics**

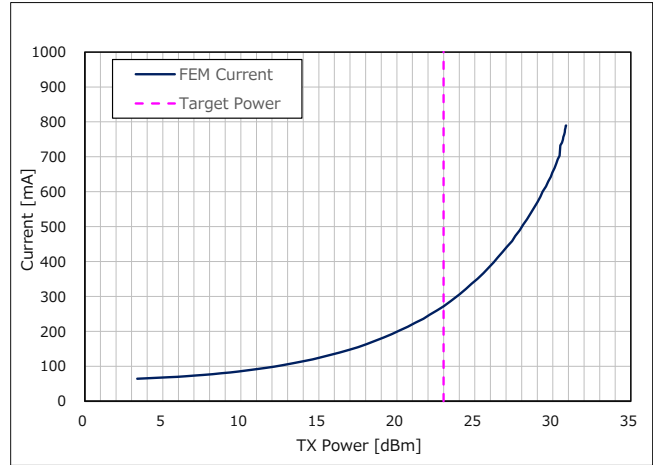
Signal condition: Frequency = 915MHz

**Table 19 TX Power sweep characteristics**

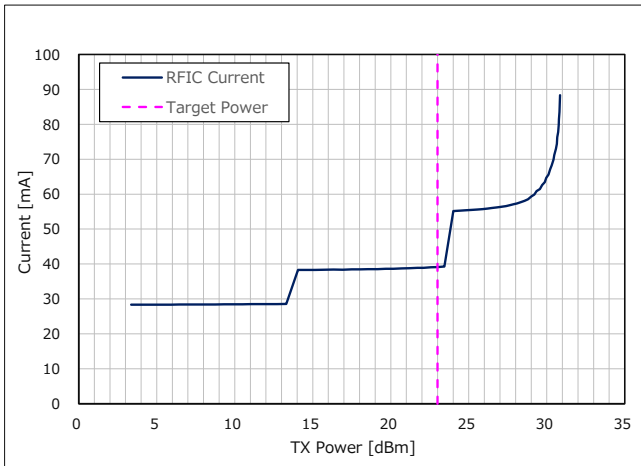
Items		Unit	Evaluation results
TX Power Range	Max	dBm	30.9
	Min		3.4
	Variable power range	dB	27.5
Current Range	V <sub>FEM</sub>	Max	789.7
		Min	64.3
	V <sub>RFIC</sub>	Max	88.4
		Min	28.4



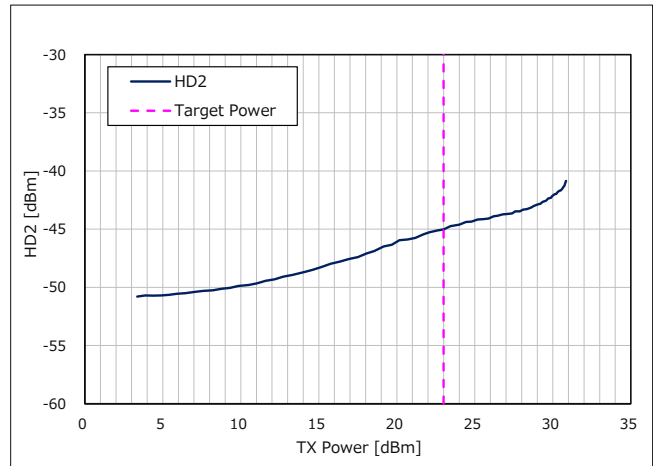
**Figure 57 Power Setting vs. TX Power (Frequency = 915MHz)**



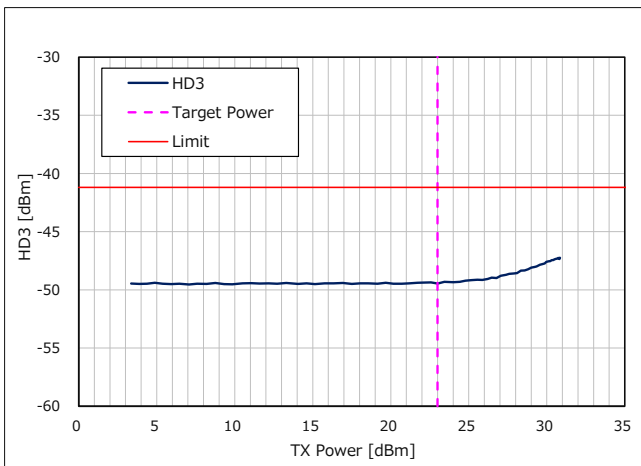
**Figure 58 TX Power vs. Current of  $V_{FEM}$  for TX mode (Frequency = 915MHz)**



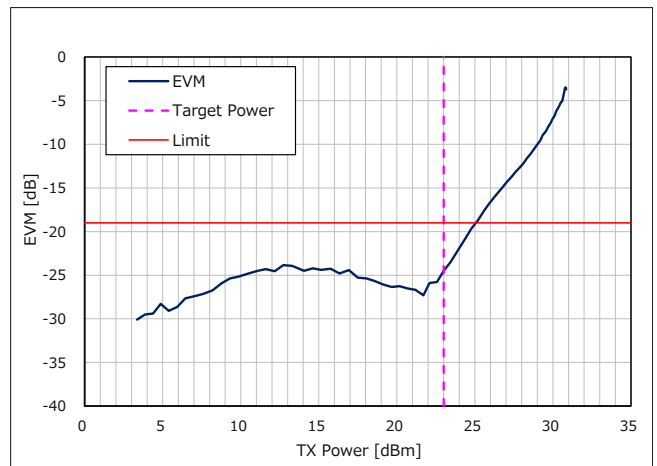
**Figure 59 TX Power vs. Current of  $V_{RFIC}$  for TX mode (Frequency = 915MHz)**



**Figure 60 TX Power vs. 2nd Harmonics (Frequency = 915MHz)**



**Figure 61 TX Power vs. 3rd Harmonics (Frequency = 915MHz)**



**Figure 62 TX Power vs. EVM (Frequency = 915MHz)**

**(2) TX Radio Regulations characteristics**

Signal condition: Target TX Power = +23dBm

**Table 20 TX Radio Regulations characteristics (1/2)**

Items		RF Frequency [MHz]	Unit	Evaluation results	Spec
TX Power		902.2	dBm	23.5	+30.0 (*1)
		915.0		23.2	
		927.8		23.2	
Harmonics	2nd	902.2	dBm /MHz	-44.8	-
		915.0		-44.9	
		927.8		-45.2	
	3rd	902.2		-48.9	-41.2 (*1)
		915.0		-49.5	
		927.8		-49.1	
Occupied Bandwidth		902.2	kHz	159.5	-
		915.0		158.7	
		927.8		158.8	
6dB Bandwidth (*2)		902.2	kHz	155.4	-
		915.0		154.6	
		927.8		153.8	
20dB Bandwidth (*2)		902.2	kHz	186.1	-
		915.0		180.3	
		927.8		181.1	
Adjacent Channel Power Ratio	Lower	902.2	dBc	-30.1	-20 (*3)
		915.0		-31.5	
		927.8		-31.7	
	Upper	902.2		-29.8	
		915.0		-31.1	
		927.8		-31.7	
Alternate Channel Power Ratio	Lower	902.2	dBc	-49.0	-40 (*3)
		915.0		-50.0	
		927.8		-50.0	
	Upper	902.2		-49.4	
		915.0		-50.4	
		927.8		-50.7	
Modulation quality	EVM	902.2	dB	-23.1	-19 (*4)
		915.0		-24.0	
		927.8		-24.0	

(\*1) FCC 47 CFR Part15, Subpart C, Section 15.247

(\*2) Since 6dB Bandwidth is less than 500kHz, Digital modulation system is not applied.

Since 20dB Bandwidth is less than 250kHz, Frequency hopping system is applied.

(\*3) Wi-SUN PHY Technical Specification - Amendment 1VA9 (11 Nov 2022)

(\*4) IEEE.802.15.4-2020



**Table 21 TX Radio Regulations characteristics (2/2)**

Items		RF Frequency [MHz]	Unit	Evaluation results	Spec
Unwanted emissions	30 - 88MHz	902.2	dBm /100kHz	-64.7	-55.2 (*1)
		915.0		-64.8	
		927.8		-63.4	
	88 - 216MHz	902.2	dBm /100kHz	-59.8	-51.7 (*1)
		915.0		-60.9	
		927.8		-60.7	
	216 - 614MHz	902.2	dBm /100kHz	-61.0	-49.2 (*1)
		915.0		-60.9	
		927.8		-62.0	
	960 - 1722.2MHz	902.2	dBm /MHz	-48.5	-41.2 (*1)
		915.0		-48.6	
		927.8		-48.7	
	2200 - 5460MHz	902.2	dBm /MHz	-48.9	-41.2 (*1)
		915.0		-49.5	
		927.8		-49.1	
	7250 - 9200MHz	902.2	dBm /MHz	-51.9	-41.2 (*1)
		915.0		-51.5	
		927.8		-51.6	
Tx out of band emission (Band edge)	Lower 870 - 902MHz	902.2	dBc	-24.2	-20 (*2)
		915.0		-72.7	
		927.8		-73.1	
	Upper 928 - 960MHz	902.2	dBc	-72.1	-20 (*2)
		915.0		-72.1	
		927.8		-25.5	

(\*1) In the FCC standard, spurious emissions are specified by electric field intensity (V / m). Since this document is the result of the wired condition, the value converted to the power value (dBm) is used.

Power (dBm)@3m =  $10 \cdot \log(300E^2)$ , E = electric field intensity (V / m)

(\*2) FCC 47 CFR Part15, Subpart C, Section 15.247

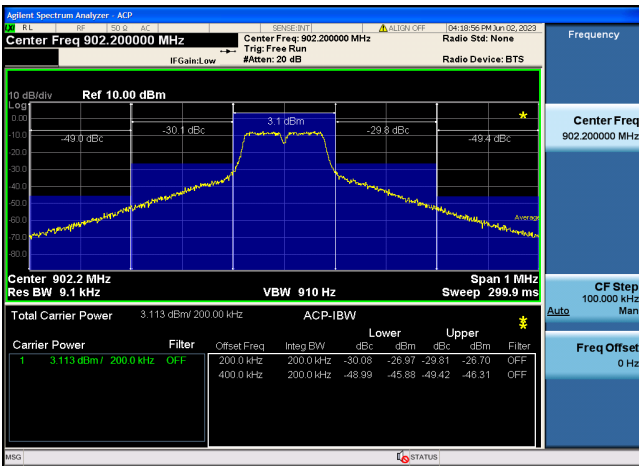


Figure 63 Transmit Spectrum (Frequency = 902.2MHz)

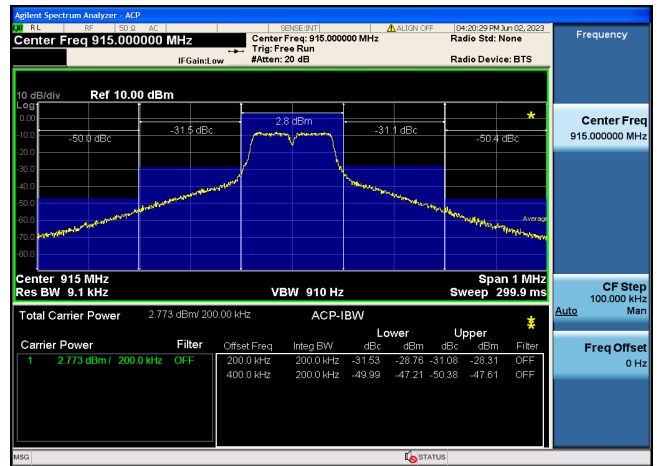


Figure 64 Transmit Spectrum (Frequency = 915MHz)

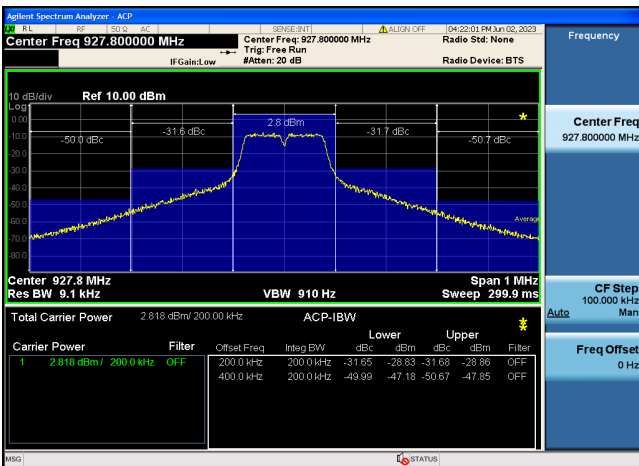


Figure 65 Transmit Spectrum (Frequency = 927.8MHz)

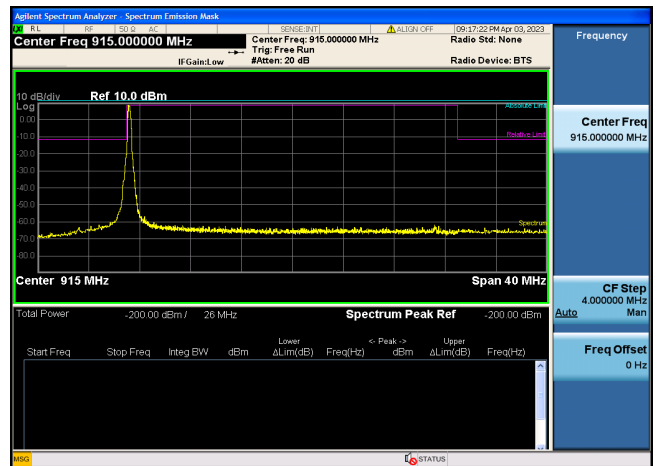


Figure 66 TX Out of Band Emissions for Operational Frequency Band (Frequency = 902.2MHz)

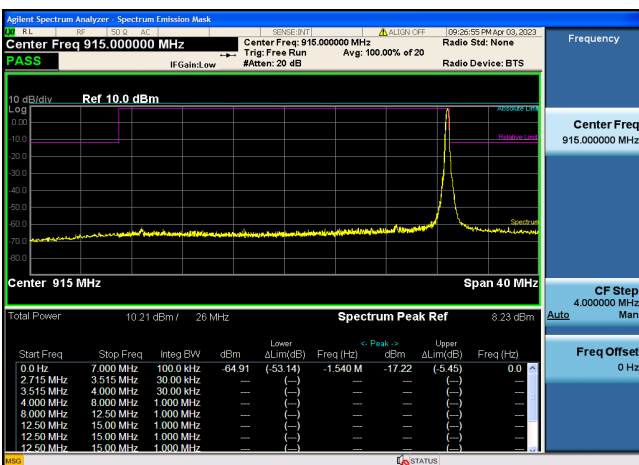


Figure 67 TX Out of Band Emissions for Operational Frequency Band (Frequency = 927.8MHz)

## 2.3 RX Electrical Characteristics

### 2.3.1 FSK (50kbps, modulation index = 1)

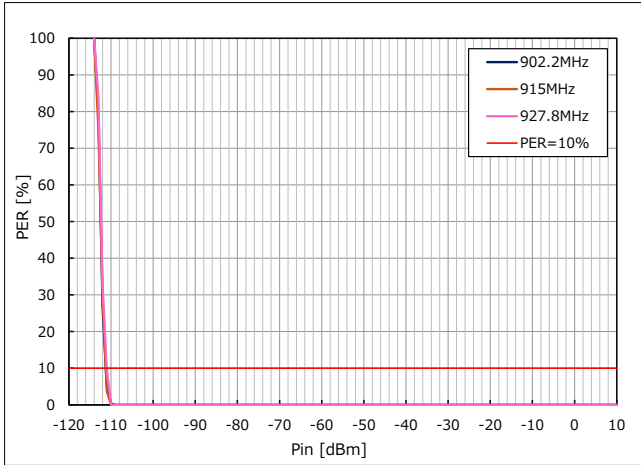
Table 22 RX Electrical Characteristics 1

Items			RF Frequency [MHz]	Unit	Evaluation result	Spec
Receiver sensitivity	PER < 10% Length 250 octets		902.2	dBm	-110	-91 (*4)
			915.0		-110	
			927.8		-110	
Maximum Input level	PER < 10% Length 250 octets		902.2	dBm	10	-
			915.0		10	
			927.8		10	
RSSI accuracy	Average	RSSI range: -110dBm to -21dBm (*1)	902.2	dB	1.0	-
			915.0		-1.0	
			927.8		-1.0	
	MAX		902.2		1.0	
			915.0		1.0	
			927.8		-1.0	
	MIN		902.2		-0.5	
			915.0		-1.0	
			927.8		-1.0	
ED accuracy	Average	ED range: -110dBm to -21dBm (*1)	902.2	dB	-1.5	-
			915.0		-2.0	
			927.8		-2.5	
	MAX		902.2		-1.5	
			915.0		-2.0	
			927.8		-2.5	
	MIN		902.2		-1.5	
			915.0		-2.0	
			927.8		-2.5	
Frequency tolerance	Max	PER < 10% Length 250 octets	915.0	ppm	≥ 50	±20
	Min				≤ -50	
Adjacent channel rejection	-200kHz	PER < 10% (*2) (*3) Length 250 octets	915.0	dB	39	10 (*4)
	+200kHz				40	
Alternate channel rejection	-400kHz	PER < 10% (*2) (*3) Length 250 octets	915.0	dB	50	30 (*4)
	+400kHz				51	
Co channel rejection	±0MHz	PER < 10% (*2) (*3) Length 250 octets	915.0	dB	-10	-
Blocking	+1MHz	PER < 10% (*2) (*3) Length 250 octets	915.0	dB	61	-
	-2MHz				65	
	+2MHz				65	
	-10MHz				69	
	+10MHz				69	
Image rejection	-1.1MHz-	PER < 10% (*2) (*3) Length 250 octets	915.0	dB	40	-
Receiver spurious emission	30 - 1000MHz		902.2	dBm /100kHz	-72.5	-
			915.0		-72.7	
			927.8		-72.7	
	1 - 10GHz		902.2	dBm /MHz	-58.5	-
			915.0		-58.3	
			927.8		-57.9	

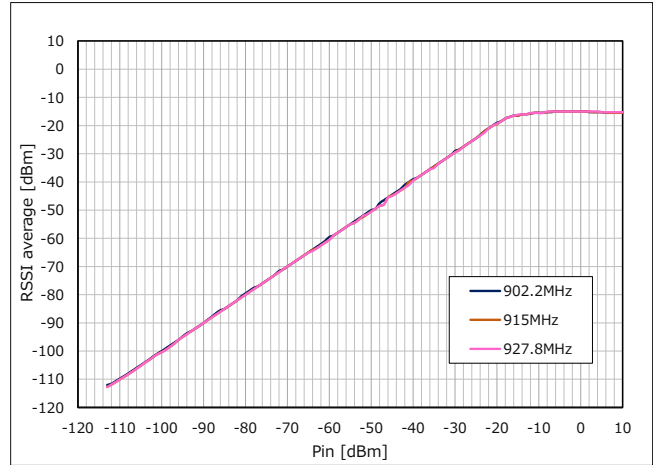
(\*1) Lower limit: RX sensitivity / Upper limit: Limit described in the user's manual (-5dBm) - FEM LNA gain (16dB).

(\*2) The level of the desired signal: RX sensitivity + 3dB (-107dBm)

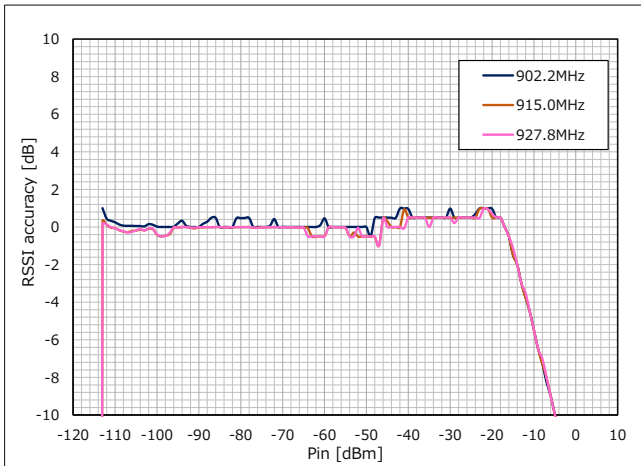
(\*3) Interference signal is non-modulated wave. (\*4) IEEE.802.15.4-2020.



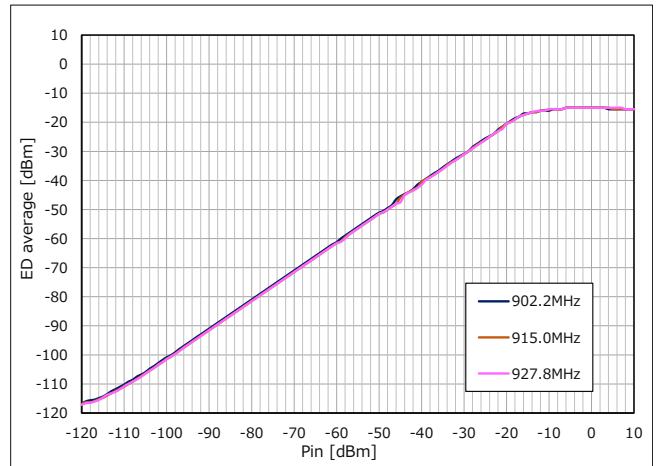
**Figure 68 RF Input Level vs. Packet Error Rate (Frequency = 902.2 / 915 / 927.8MHz)**



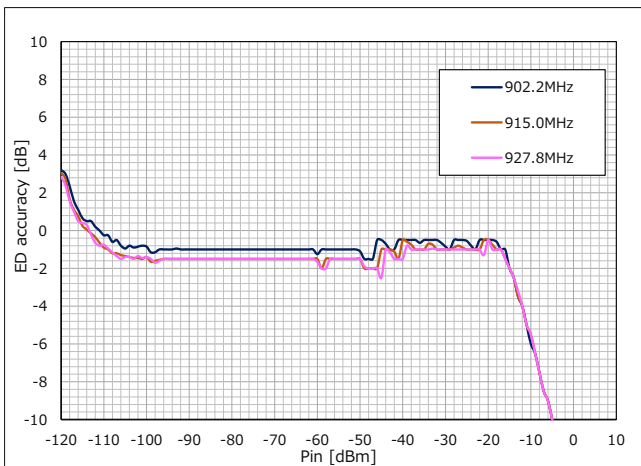
**Figure 69 RF Input Level vs. RSSI average (Frequency = 902.2 / 915 / 927.8MHz)**



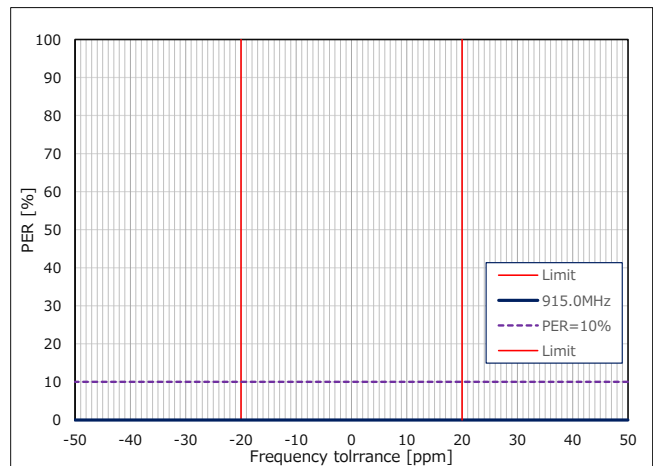
**Figure 70 RF Input Level vs. RSSI accuracy (Frequency = 902.2 / 915 / 927.8MHz)**



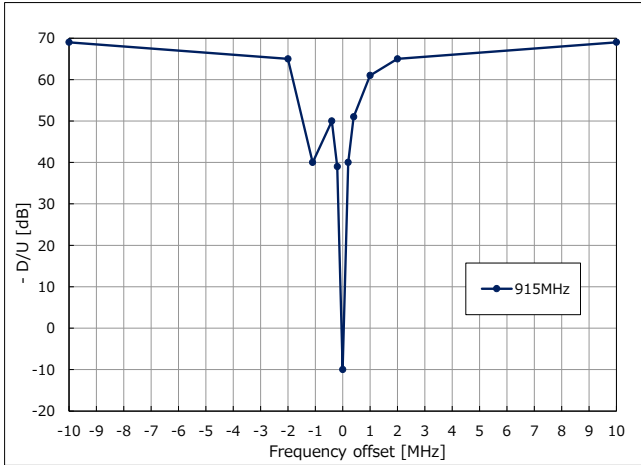
**Figure 71 RF Input Level vs. ED average (Frequency = 902.2 / 915 / 927.8MHz)**



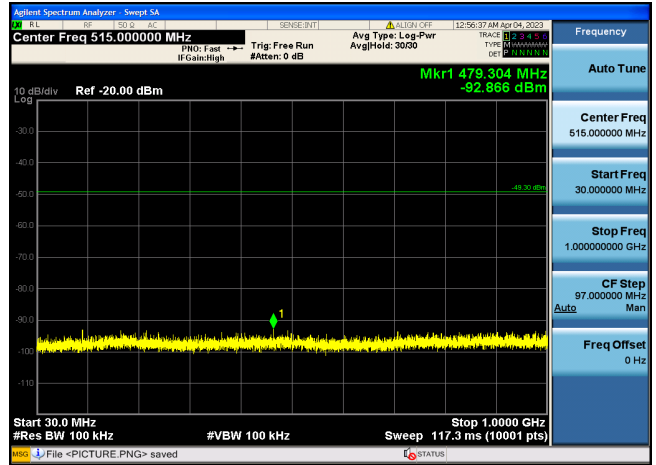
**Figure 72 RF Input Level vs. ED accuracy (Frequency = 902.2 / 915 / 927.8MHz)**



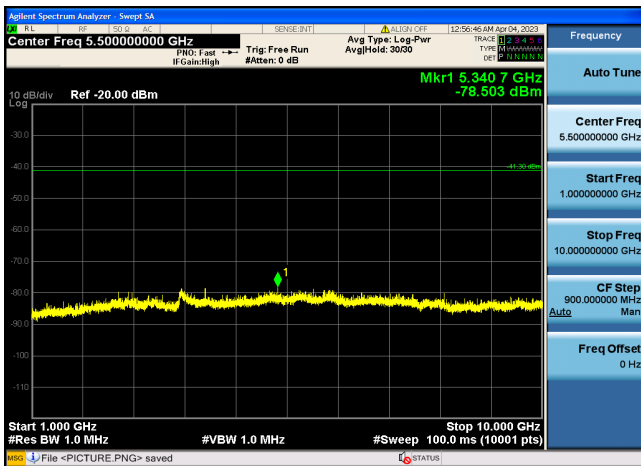
**Figure 73 RF Frequency tolerance vs. Packet Error Rate (Frequency = 915MHz)**



**Figure 74 RF Frequency offset vs. Desire/Unwanted Signal Ratio (Frequency = 915MHz)**



**Figure 75 Receiver spurious emission (30MHz -1GHz) (Frequency = 915MHz)**



**Figure 76 Receiver spurious emission (1GHz -10GHz) (Frequency = 915MHz)**

## 2.3.2 FSK (150kbps, modulation index = 0.5)

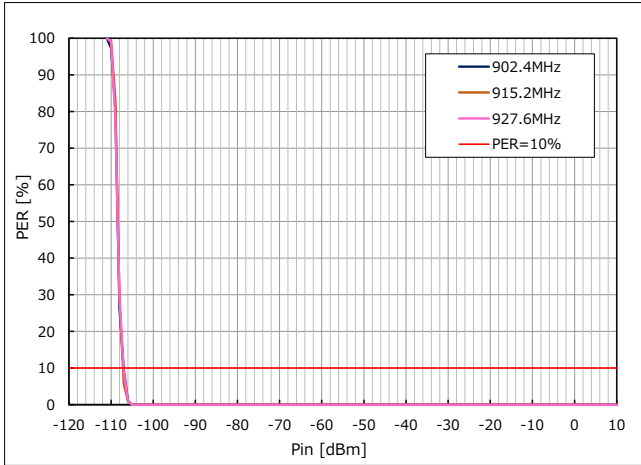
Table 23 RX Electrical Characteristics 2

Items			RF Frequency [MHz]	Unit	Evaluation result	Spec
Receiver sensitivity	PER < 10% Length 250 octets		902.4	dBm	-105	-86.2 (*4)
			915.2		-106	
			927.6		-106	
Maximum Input level	PER < 10% Length 250 octets		902.4	dBm	10	-
			915.2		10	
			927.6		10	
RSSI accuracy	Average	RSSI range: -106dBm to -21dBm (*1)	902.4	dB	0.9	-
			915.2		-1.0	
			927.6		-1.0	
	MAX		902.4		1.0	
			915.2		-1.0	
			927.6		-1.0	
	MIN		902.4		-1.0	
			915.2		-1.5	
			927.6		-1.5	
ED accuracy	Average	ED range: -106dBm to -21dBm (*1)	902.4	dB	-1.5	-
			915.2		-2.4	
			927.6		-2.5	
	MAX		902.4		-1.5	
			915.2		-2.0	
			927.6		-2.5	
	MIN		902.4		-1.5	
			915.2		-2.5	
			927.6		-2.5	
Frequency tolerance	Max	PER < 10% Length 250 octets	915.2	ppm	≥ 50	±20
	Min				≤ -50	
Adjacent channel rejection	-400kHz	PER < 10% (*2) (*3) Length 250 octets	915.2	dB	45	10 (*4)
	+400kHz				46	
Alternate channel rejection	-800kHz	PER < 10% (*2) (*3) Length 250 octets	915.2	dB	55	30 (*4)
	+800kHz				56	
Co channel rejection	±0MHz	PER < 10% (*2) (*3) Length 250 octets	915.2	dB	-8	-
Blocking	+1MHz	PER < 10% (*2) (*3) Length 250 octets	915.2	dB	57	-
	-2MHz				61	
	+2MHz				61	
	-10MHz				62	
	+10MHz				62	
Image rejection	-1.1MHz-	PER < 10% (*2) (*3) Length 250 octets	915.2	dB	43	-
Receiver spurious emission	30 - 1000MHz		902.4	dBm /100kHz	-72.1	-
			915.2		-72.9	
			927.6		-72.6	
	1 - 10GHz		902.4	dBm /MHz	-57.5	-
			915.2		-57.5	
			927.6		-57.9	

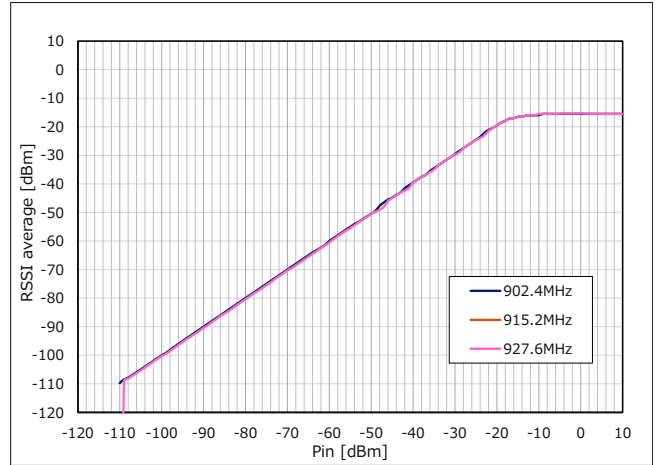
(\*1) Lower limit: RX sensitivity / Upper limit: Limit described in the user's manual (-5dBm) - FEM LNA gain (16dB).

(\*2) The level of the desired signal: RX sensitivity + 3dB (-103dBm)

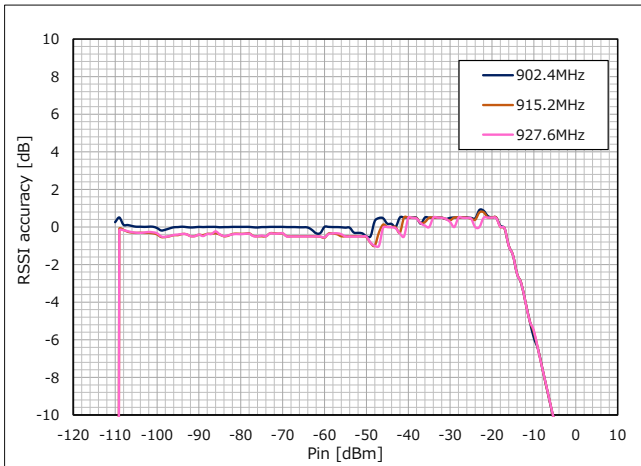
(\*3) Interference signal is non-modulated wave. (\*4) IEEE.802.15.4-2020.



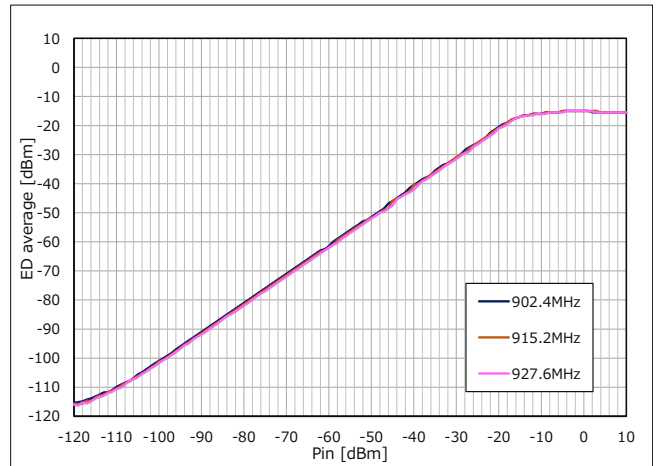
**Figure 77 RF Input Level vs. Packet Error Rate**  
(Frequency = 902.4 / 915.2 / 927.6MHz)



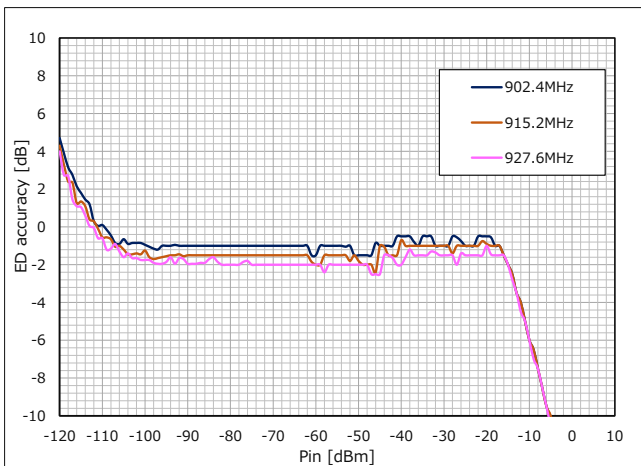
**Figure 78 RF Input Level vs. RSSI average**  
(Frequency = 902.4 / 915.2 / 927.6MHz)



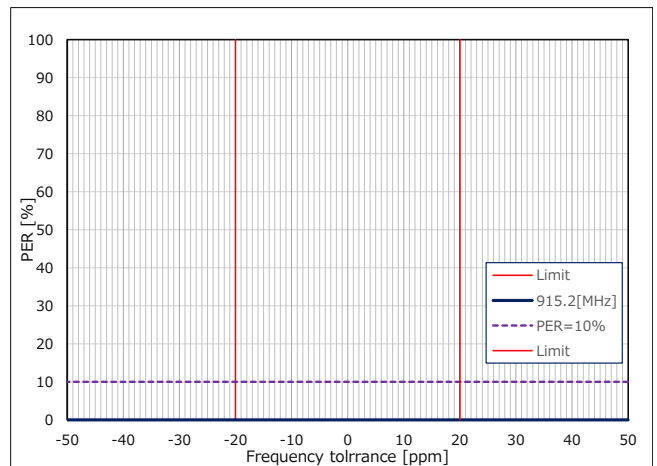
**Figure 79 RF Input Level vs. RSSI accuracy**  
(Frequency = 902.4 / 915.2 / 927.6MHz)



**Figure 80 RF Input Level vs. ED average**  
(Frequency = 902.4 / 915.2 / 927.6MHz)



**Figure 81 RF Input Level vs. ED accuracy**  
(Frequency = 902.4 / 915.2 / 927.6MHz)



**Figure 82 RF Frequency tolerance vs. Packet Error Rate**  
(Frequency = 915.2MHz)

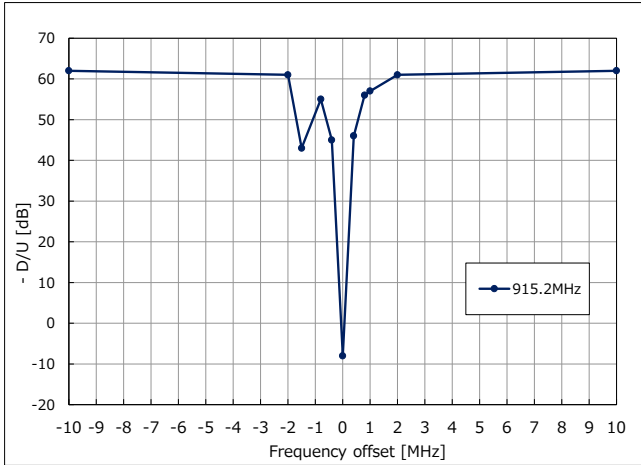


Figure 83 RF Frequency offset vs. Desire/Unwanted Signal Ratio (Frequency = 915.2MHz)

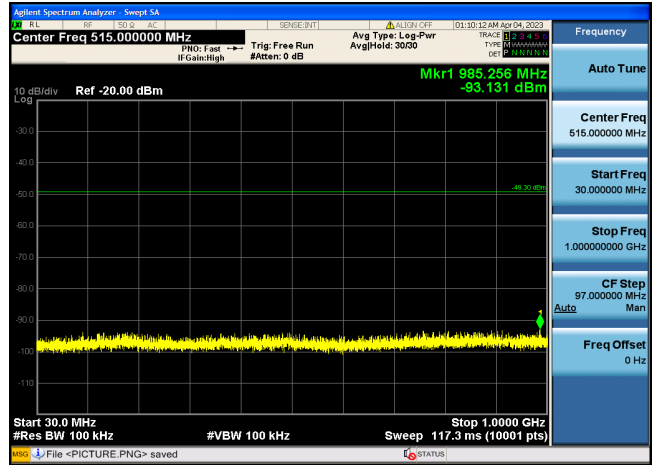


Figure 84 Receiver spurious emission (30MHz -1GHz) (Frequency = 915.2MHz)

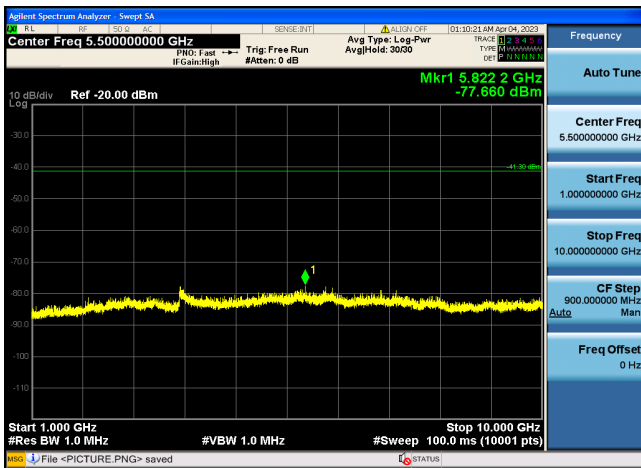


Figure 85 Receiver spurious emission (1GHz -10GHz) (Frequency = 915.2MHz)



**2.3.3 OFDM (Option1, MCS6)**
**Table 24 RX Electrical Characteristics 3**

Items			RF Frequency [MHz]	Unit	Evaluation result	Spec
Receiver sensitivity	PER < 10% Length 250 octets		903.2	dBm	-97	-85 (*6)
			915.2		-97	
			927.2		-97	
Maximum Input level	PER < 10% Length 250 octets		903.2	dBm	-13	-
			915.2		-12	
			927.2		-13	
RSSI accuracy	Average	RSSI range: -97dBm to -21dBm (*1)	903.2	dB	-1.2	-
			915.2		-2.0	
			927.2		-1.5	
	MAX		903.2		-1.0	
			915.2		-2.0	
			927.2		-1.5	
	MIN		903.2		-1.5	
			915.2		-2.0	
			927.2		-1.5	
ED accuracy	Average	ED range: -97dBm to -21dBm (*1)	903.2	dB	-2.0	-
			915.2		-2.5	
			927.2		-2.5	
	MAX		903.2		-2.0	
			915.2		-2.5	
			927.2		-2.5	
	MIN		903.2		-2.0	
			915.2		-2.5	
			927.2		-2.5	
Frequency tolerance	Max	PER < 10% Length 250 octets	915.2	ppm	≥ 50	±20
	Min				≤ -50	
Adjacent channel rejection	-1.2MHz	PER < 10% (*2) (*3) (*5) Length 250 octets	915.2	dB	23	2 (*7)
	+1.2MHz				22	
Alternate channel rejection	-2.4MHz	PER < 10% (*2) (*3) (*5) Length 250 octets	915.2	dB	40	26 (*7)
	+2.4MHz				41	
Co channel rejection	±0MHz	PER < 10% (*2) (*4) (*5) Length 250 octets	915.2	dB	-16	-23 (*7)
Blocking	-10MHz	PER < 10% (*2) (*3) (*5) Length 250 octets	915.2	dB	44	-
	+10MHz				45	
Image rejection	-1.3MHz	PER < 10% (*2) (*3) (*5) Length 250 octets	915.2	dB	22	-
Receiver spurious emission	30 - 1000MHz		903.2	dBm /100kHz	-73.0	-
			915.2		-72.0	
			927.2		-72.7	
	1 - 10GHz		903.2	dBm /MHz	-58.0	-
			915.2		-57.9	
			927.2		-58.0	

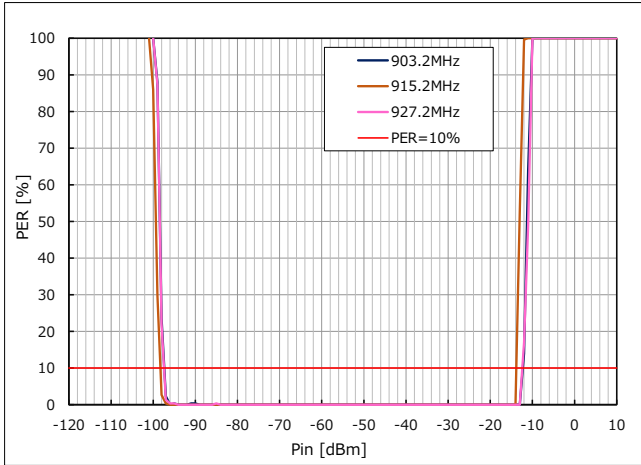
(\*1) Lower limit: RX sensitivity / Upper limit: Limit described in the user's manual (-5dBm) - FEM LNA gain (16dB).

(\*2) The level of the desired signal: RX sensitivity + 3dB (-94dBm)

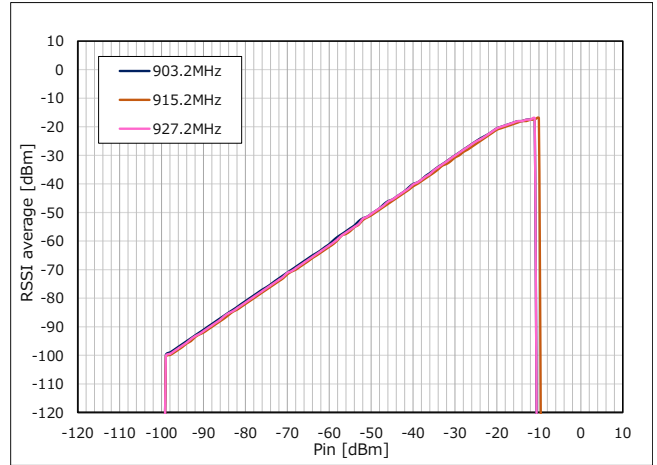
(\*3) Interference signal pattern defined by the certification body (\*4) Interference signal pattern without LTF and STF defined by Wi-SUN.

(\*5) Interference signal is modulated wave. (\*6) IEEE.802.15.4-2020.

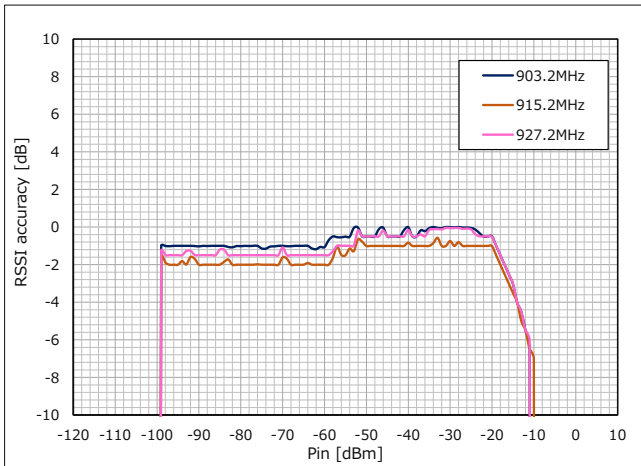
(\*7) Wi-SUN PHY Technical Specification - Amendment 1VA9 (11 Nov 2022)



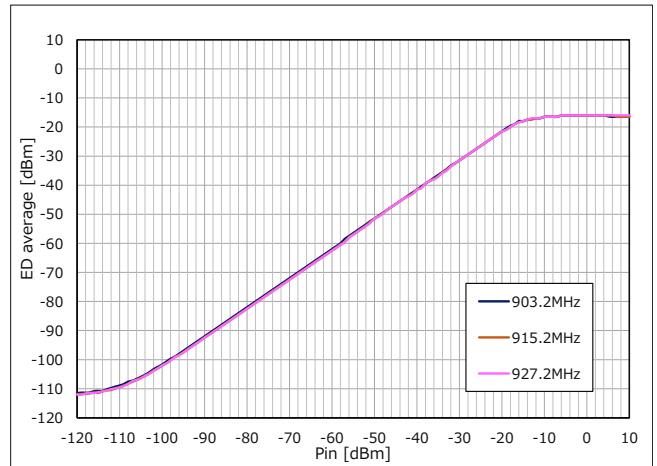
**Figure 86 RF Input Level vs. Packet Error Rate**  
(Frequency = 903.2 / 915.2 / 927.2MHz)



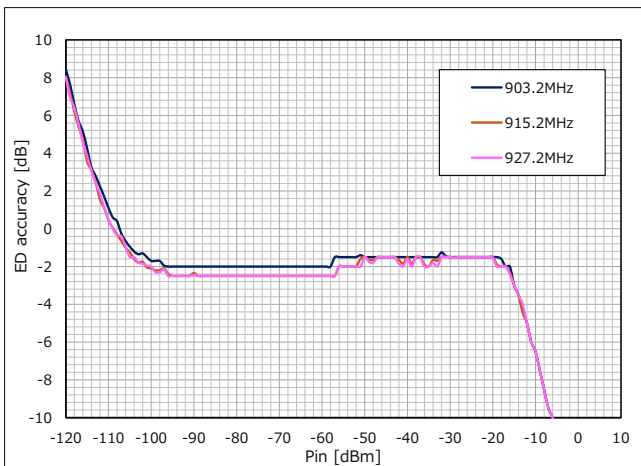
**Figure 87 RF Input Level vs. RSSI average**  
(Frequency = 903.2 / 915.2 / 927.2MHz)



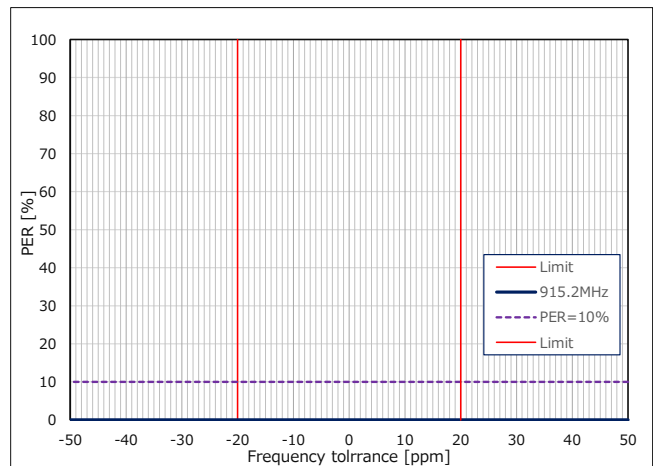
**Figure 88 RF Input Level vs. RSSI accuracy**  
(Frequency = 903.2 / 915.2 / 927.2MHz)



**Figure 89 RF Input Level vs. ED average**  
(Frequency = 903.2 / 915.2 / 927.2MHz)



**Figure 90 RF Input Level vs. ED accuracy**  
(Frequency = 903.2 / 915.2 / 927.2MHz)



**Figure 91 RF Frequency tolerance vs. Packet Error Rate**  
(Frequency = 915.2MHz)

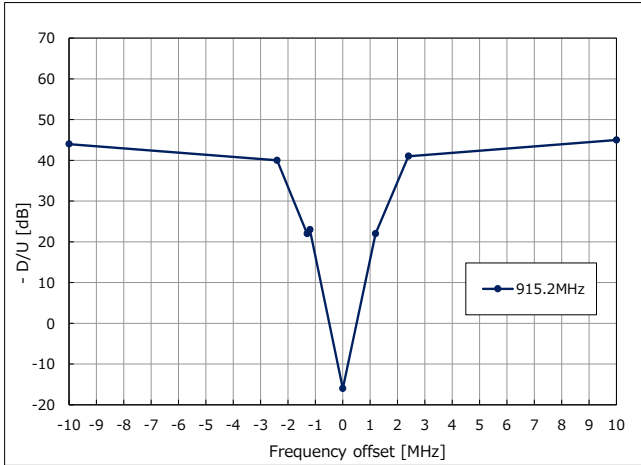


Figure 92 RF Frequency offset vs. Desire/Unwanted Signal Ratio (Frequency = 915.2MHz)

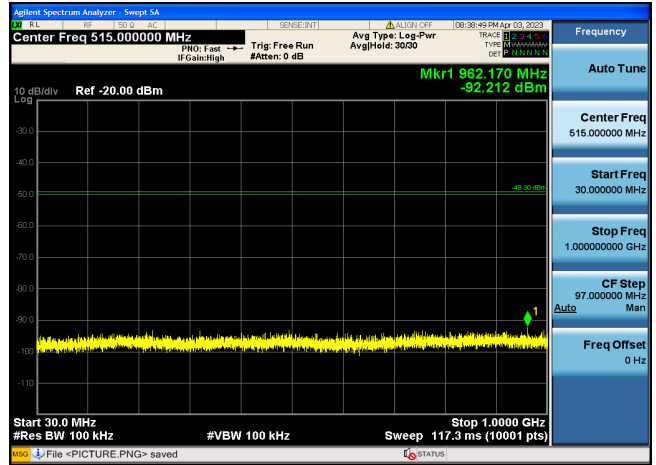


Figure 93 Receiver spurious emission (30MHz -1GHz) (Frequency = 915.2MHz)

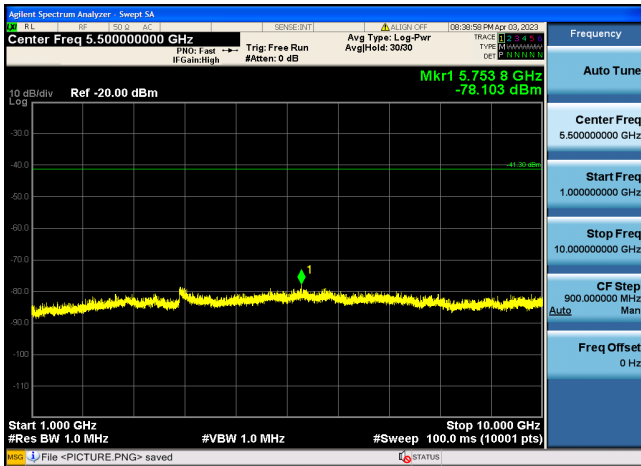


Figure 94 Receiver spurious emission (1GHz -10GHz) (Frequency = 915.2MHz)

## 2.3.4 OFDM (Option2, MCS6)

Table 25 RX Electrical Characteristics 4

Items			RF Frequency [MHz]	Unit	Evaluation result	Spec
Receiver sensitivity	PER < 10% Length 250 octets		902.8	dBm	-100	-88 (*6)
			914.8		-100	
			927.6		-100	
Maximum Input level	PER < 10% Length 250 octets		902.8	dBm	-18	-
			914.8		-18	
			927.6		-18	
RSSI accuracy	Average	RSSI range: -100dBm to -21dBm (*1)	902.8	dB	0.8	-
			914.8		0.6	
			927.6		-0.5	
	MAX		902.8		1.0	
			914.8		1.0	
			927.6		1.0	
	MIN		902.8		-0.5	
			914.8		-1.0	
			927.6		-1.0	
ED accuracy	Average	ED range: -100dBm to -21dBm (*1)	902.8	dB	-1.5	-
			914.8		-2.0	
			927.6		-2.0	
	MAX		902.8		-1.5	
			914.8		-2.0	
			927.6		-2.0	
	MIN		902.8		-1.5	
			914.8		-2.0	
			927.6		-2.0	
Frequency tolerance	Max	PER < 10% Length 250 octets	914.8	ppm	≥ 50	±20
	Min				≤ -50	
Adjacent channel rejection	-800kHz	PER < 10% (*2) (*3) (*5) Length 250 octets	914.8	dB	26	2 (*7)
	+800kHz				31	
Alternate channel rejection	-1.6MHz	PER < 10% (*2) (*3) (*5) Length 250 octets	914.8	dB	43	26 (*7)
	+1.6MHz				47	
Co channel rejection	±0MHz	PER < 10% (*2) (*4) (*5) Length 250 octets	914.8	dB	-16	-23 (*7)
Blocking	-2MHz	PER < 10% (*2) (*3) (*5) Length 250 octets	914.8	dB	47	-
	+2MHz				46	
	-10MHz				49	
	+10MHz				50	
Image rejection	-1.04MHz	PER < 10% (*2) (*3) (*5) Length 250 octets	914.8	dB	25	-
Receiver spurious emission	30 - 1000MHz		902.8	dBm /100kHz	-72.0	-
			914.8		-73.0	
			927.6		-72.5	
	1 - 10GHz		902.8	dBm /MHz	-58.0	-
			914.8		-57.8	
			927.6		-58.0	

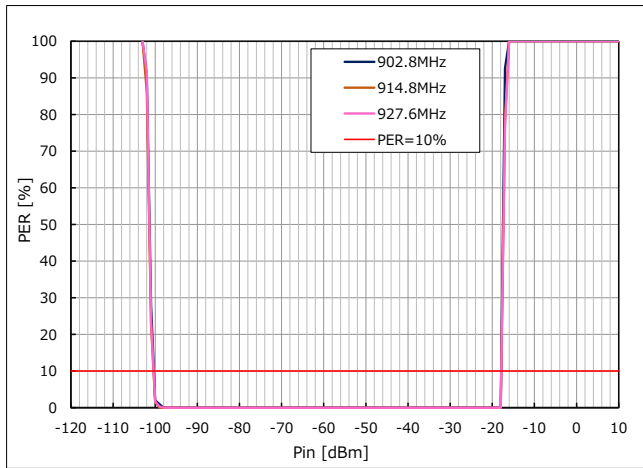
(\*1) Lower limit: RX sensitivity / Upper limit: Limit described in the user's manual (-5dBm) - FEM LNA gain (16dB).

(\*2) The level of the desired signal: RX sensitivity + 3dB (-97dBm)

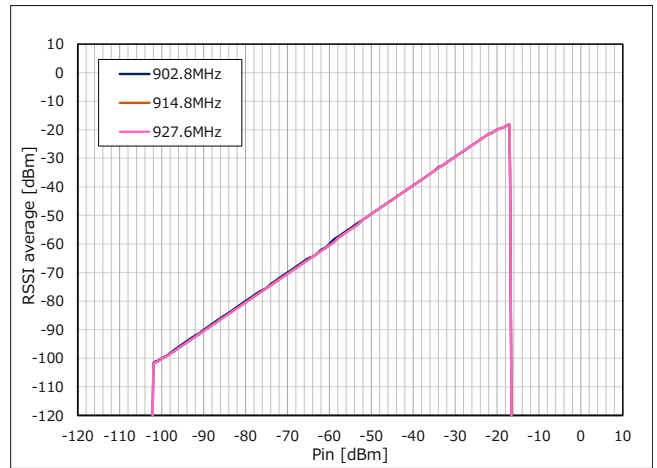
(\*3) Interference signal pattern defined by the certification body (\*4) Interference signal pattern without LTF and STF defined by Wi-SUN.

(\*5) Interference signal is modulated wave. (\*6) IEEE.802.15.4-2020.

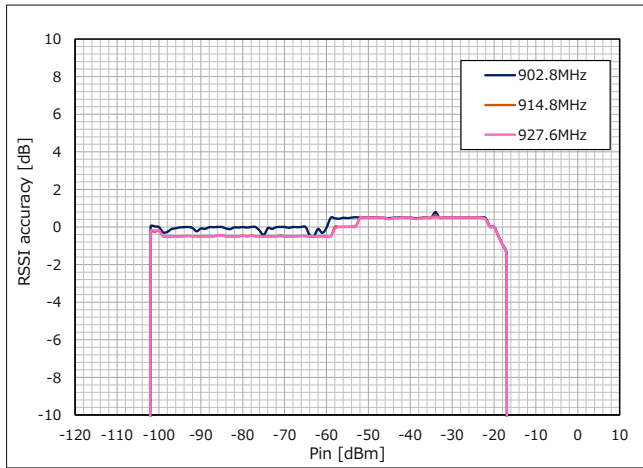
(\*7) Wi-SUN PHY Technical Specification - Amendment 1VA9 (11 Nov 2022)



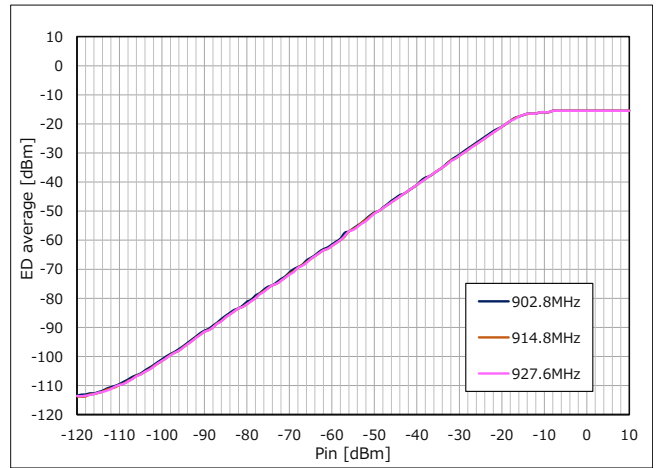
**Figure 95 RF Input Level vs. Packet Error Rate**  
(Frequency = 902.8 / 914.8 / 927.6MHz)



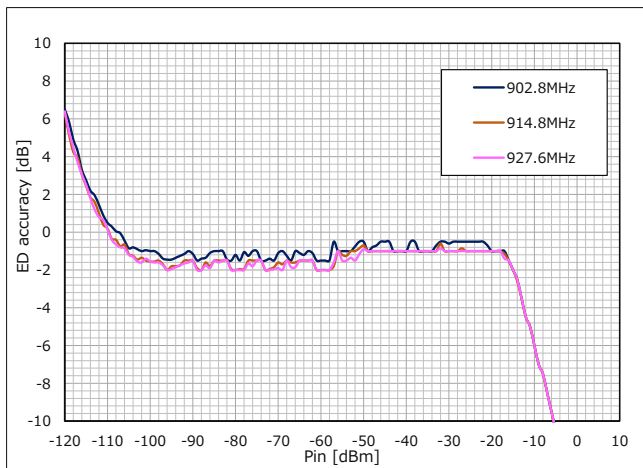
**Figure 96 RF Input Level vs. RSSI average**  
(Frequency = 902.8 / 914.8 / 927.6MHz)



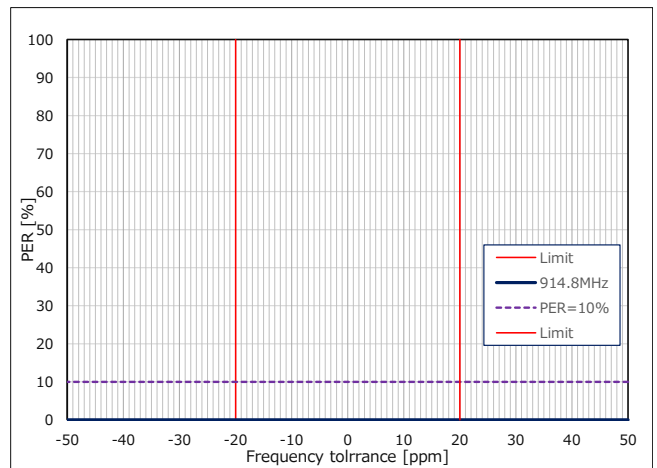
**Figure 97 RF Input Level vs. RSSI accuracy**  
(Frequency = 902.8 / 914.8 / 927.6MHz)



**Figure 98 RF Input Level vs. ED average**  
(Frequency = 902.8 / 914.8 / 927.6MHz)



**Figure 99 RF Input vs. Level ED accuracy**  
(Frequency = 902.8 / 914.8 / 927.6MHz)



**Figure 100 RF Frequency tolerance vs. Packet Error Rate**  
(Frequency = 914.8MHz)

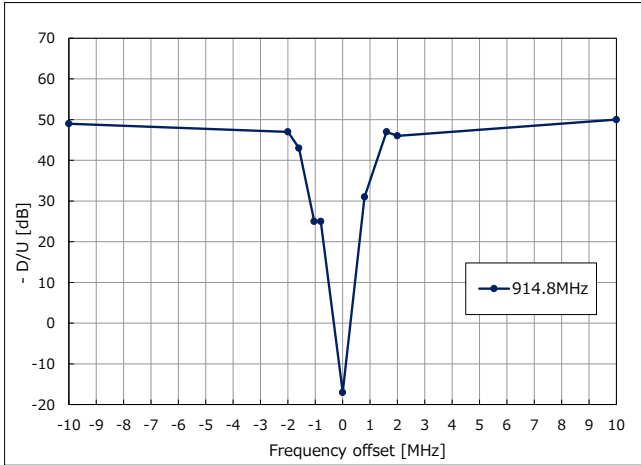


Figure 101 RF Frequency offset vs. Desire/Unwanted Signal Ratio (Frequency = 914.8MHz)

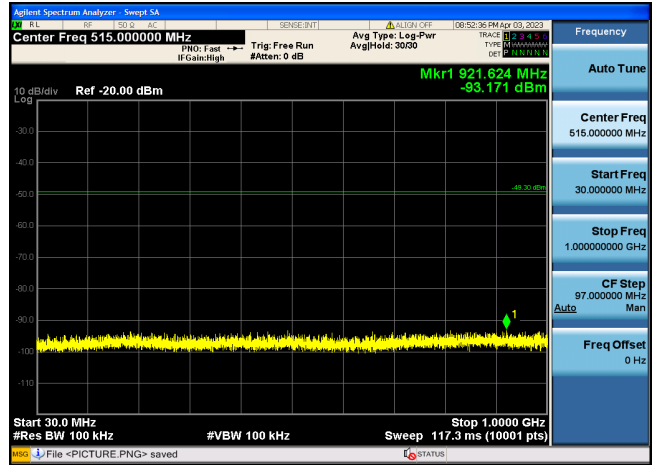


Figure 102 Receiver spurious emission (30MHz -1GHz) (Frequency = 914.8MHz)

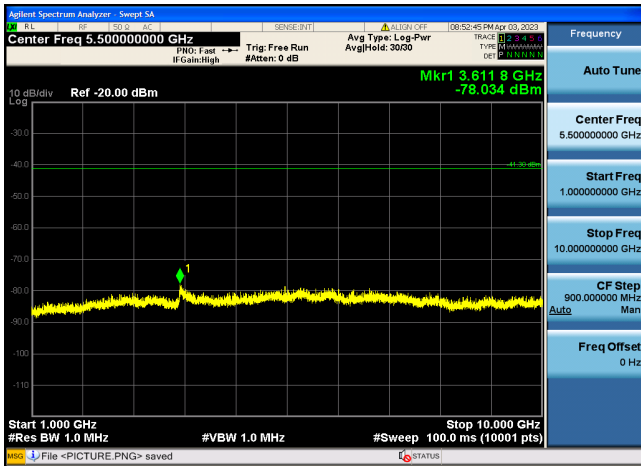


Figure 103 Receiver spurious emission (1GHz -10GHz) (Frequency = 914.8MHz)

## 2.3.5 OFDM (Option3, MCS6)

Table 26 RX Electrical Characteristics 5

Items			RF Frequency [MHz]	Unit	Evaluation result	Spec
Receiver sensitivity	PER < 10% Length 250 octets		902.4	dBm	-103	-91 (*6)
			915.2		-103	
			927.6		-103	
Maximum Input level	PER < 10% Length 250 octets		902.4	dBm	-15	-
			915.2		-15	
			927.6		-15	
RSSI accuracy	Average	RSSI range: -103dBm to -21dBm (*1)	902.4	dB	1.1	-
			915.2		1.0	
			927.6		1.0	
	MAX		902.4		1.5	
			915.2		1.0	
			927.6		1.0	
	MIN		902.4		1.0	
			915.2		1.0	
			927.6		1.0	
ED accuracy	Average	ED range: -103dBm to -21dBm (*1)	902.4	dB	-1.5	-
			915.2		-2.0	
			927.6		-2.0	
	MAX		902.4		-1.5	
			915.2		-2.0	
			927.6		-2.0	
	MIN		902.4		-1.5	
			915.2		-2.0	
			927.6		-2.0	
Frequency tolerance	Max	PER < 10% Length 250 octets	915.2	ppm	≥ 50	±20
	Min				≤ -50	
Adjacent channel rejection	-400kHz	PER < 10% (*2) (*3) (*5) Length 250 octets	915.2	dB	31	2 (*7)
	+400kHz				32	
Alternate channel rejection	-800kHz	PER < 10% (*2) (*3) (*5) Length 250 octets	915.2	dB	44	26 (*7)
	+800kHz				45	
Co channel rejection	±0MHz	PER < 10% (*2) (*4) (*5) Length 250 octets	915.2	dB	-16	-23 (*7)
Blocking	+1MHz	PER < 10% (*2) (*3) (*5) Length 250 octets	915.2	dB	47	-
	-2MHz				50	
	+2MHz				51	
	-10MHz				51	
	+10MHz				52	
Image rejection	-1.5MHz	PER < 10% (*2) (*3) (*5) Length 250 octets	915.2	dB	28	-
Receiver spurious emission	30 - 1000MHz		902.4	dBm /100kHz	-72.6	-
			915.2		-72.3	
			927.6		-71.3	
	1 - 10GHz		902.4	dBm /MHz	-58.4	-
			915.2		-58.2	
			927.6		-57.9	

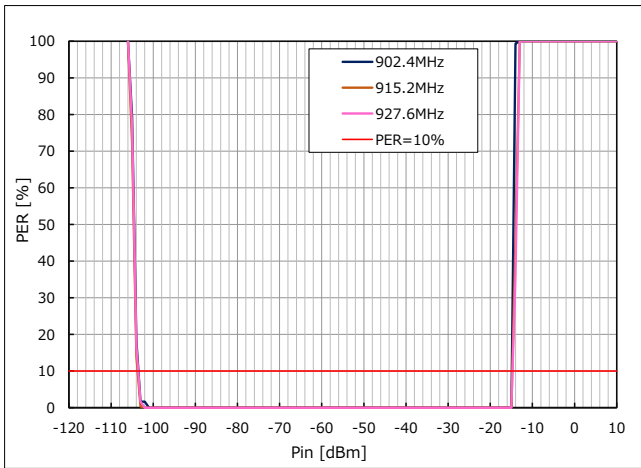
(\*1) Lower limit: RX sensitivity / Upper limit: Limit described in the user's manual (-5dBm) - FEM LNA gain (16dB).

(\*2) The level of the desired signal: RX sensitivity + 3dB (-100dBm)

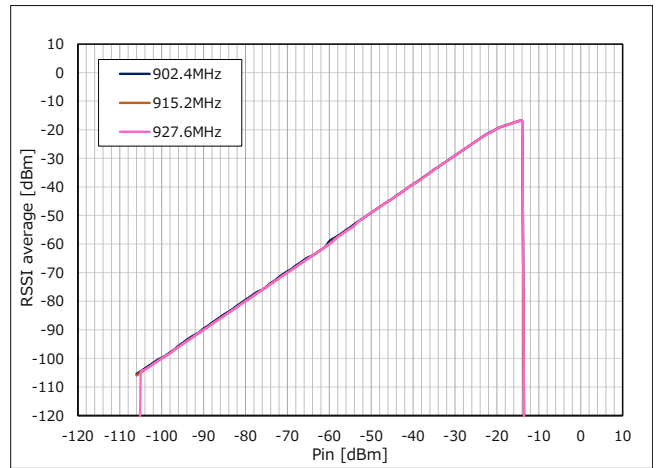
(\*3) Interference signal pattern defined by the certification body (\*4) Interference signal pattern without LTF and STF defined by Wi-SUN.

(\*5) Interference signal is modulated wave. (\*6) IEEE.802.15.4-2020.

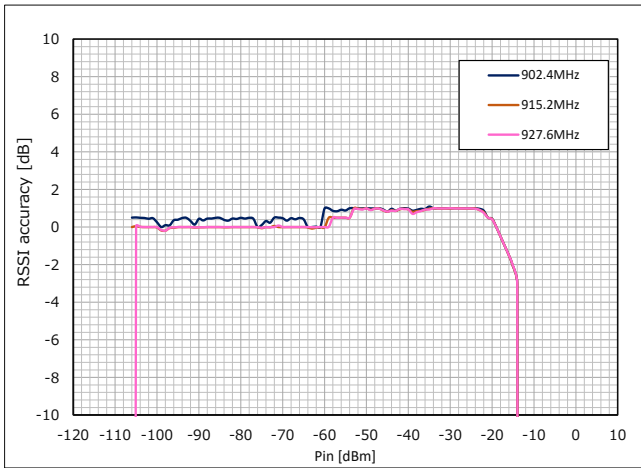
(\*7) Wi-SUN PHY Technical Specification - Amendment 1VA9 (11 Nov 2022)



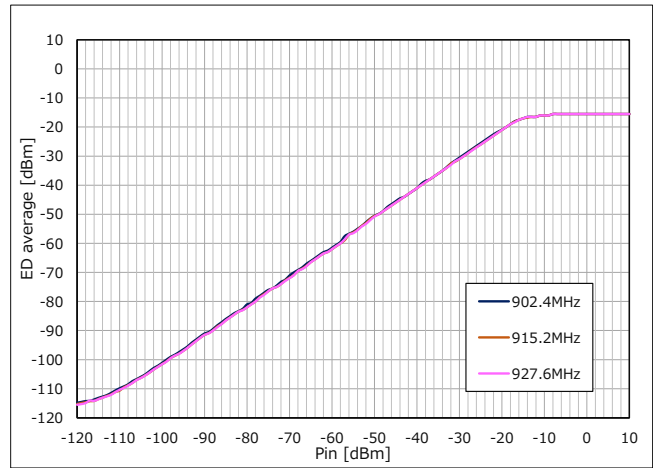
**Figure 104 RF Input Level vs. Packet Error Rate**  
(Frequency = 902.4 / 915.2 / 927.6MHz)



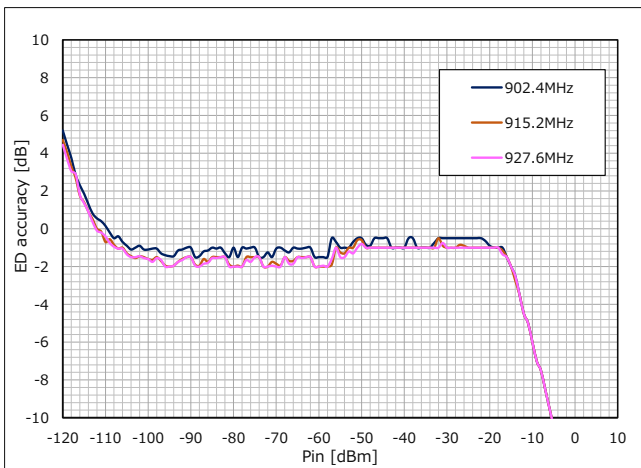
**Figure 105 RF Input Level vs. RSSI average**  
(Frequency = 902.4 / 915.2 / 927.6MHz)



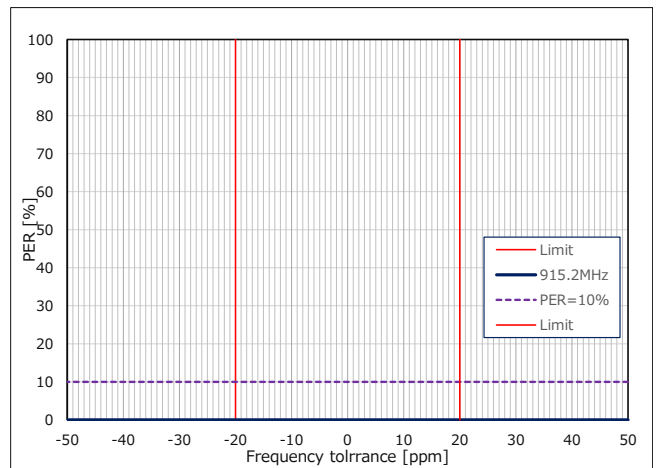
**Figure 106 RF Input Level vs. RSSI accuracy**  
(Frequency = 902.4 / 915.2 / 927.6MHz)



**Figure 107 RF Input Level vs. ED average**  
(Frequency = 902.4 / 915.2 / 927.6MHz)

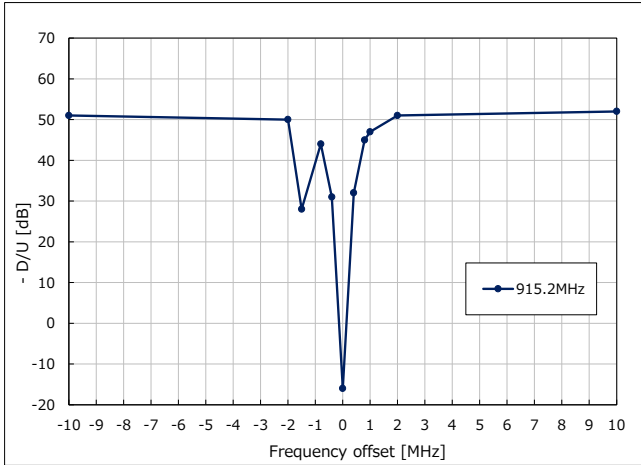


**Figure 108 RF Input Level vs. ED accuracy**  
(Frequency = 902.4 / 915.2 / 927.6MHz)

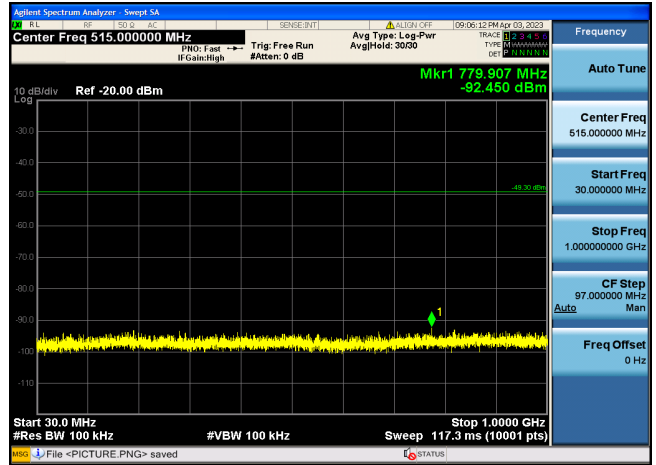


**Figure 109 RF Frequency tolerance vs. Packet Error Rate**  
(Frequency = 915.2MHz)

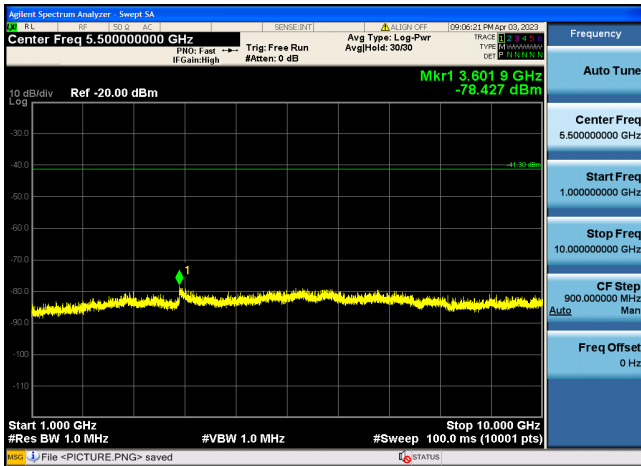




**Figure 110 RF Frequency offset vs. Desire/Unwanted Signal Ratio (Frequency = 915.2MHz)**



**Figure 111 Receiver spurious emission (30MHz -1GHz) (Frequency = 915.2MHz)**



**Figure 112 Receiver spurious emission (1GHz -10GHz) (Frequency = 915.2MHz)**

## 2.3.6 OFDM (Option4, MCS6)

Table 27 RX Electrical Characteristics 6

Items			RF Frequency [MHz]	Unit	Evaluation result	Spec
Receiver sensitivity	PER < 10% Length 250 octets		902.2	dBm	-106	-94 (*6)
			915.0		-106	
			927.8		-106	
Maximum Input level	PER < 10% Length 250 octets		902.2	dBm	-16	-
			915.0		-14	
			927.8		-14	
RSSI accuracy	Average	RSSI range: -106dBm to -21dBm (*1)	902.2	dB	1.4	-
			915.0		0.9	
			927.8		-1.0	
	MAX		902.2		1.5	
			915.0		1.0	
			927.8		-1.0	
	MIN		902.2		1.0	
			915.0		-1.0	
			927.8		-1.5	
ED accuracy	Average	ED range: -106dBm to -21dBm (*1)	902.2	dB	-1.5	-
			915.0		-1.9	
			927.8		-2.0	
	MAX		902.2		-1.5	
			915.0		-2.0	
			927.8		-2.0	
	MIN		902.2		-1.5	
			915.0		-1.5	
			927.8		-2.0	
Frequency tolerance	Max	PER < 10% Length 250 octets	915.0	ppm	-40	±20
	Min				40	
Adjacent channel rejection	-200kHz	PER < 10% (*2) (*3) (*5) Length 250 octets	915.0	dB	25	2 (*7)
	+200kHz				22	
Alternate channel rejection	-400kHz	PER < 10% (*2) (*3) (*5) Length 250 octets	915.0	dB	36	26 (*7)
	+400kHz				30	
Co channel rejection	±0MHz	PER < 10% (*2) (*4) (*5) Length 250 octets	915.0	dB	-16	-23 (*7)
Blocking	+1MHz	PER < 10% (*2) (*3) (*5) Length 250 octets	915.0	dB	44	-
	-2MHz				54	
	+2MHz				54	
	-10MHz				54	
	+10MHz				55	
Image rejection	-1.1MHz	PER < 10% (*2) (*3) (*5) Length 250 octets	915.0	dB	31	-
Receiver spurious emission	30 - 1000MHz		902.2	dBm /100kHz	-72.3	-
			915.0		-72.2	
			927.8		-72.7	
	1 - 10GHz		902.2	dBm /MHz	-58.3	-
			915.0		-58.4	
			927.8		-57.9	

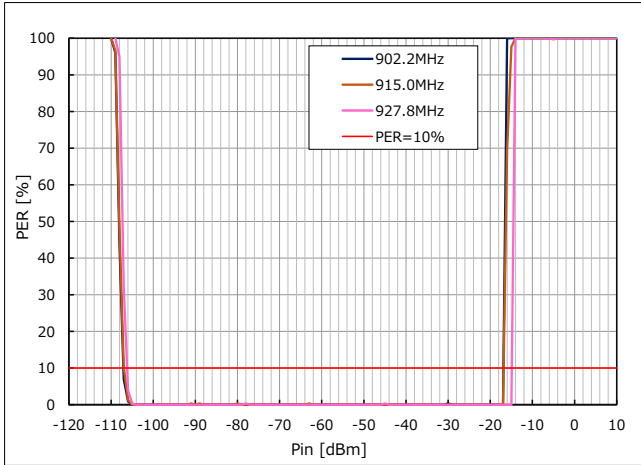
(\*1) Lower limit: RX sensitivity / Upper limit: Limit described in the user's manual (-5dBm) - FEM LNA gain (16dB).

(\*2) The level of the desired signal: RX sensitivity + 3dB (-103dBm)

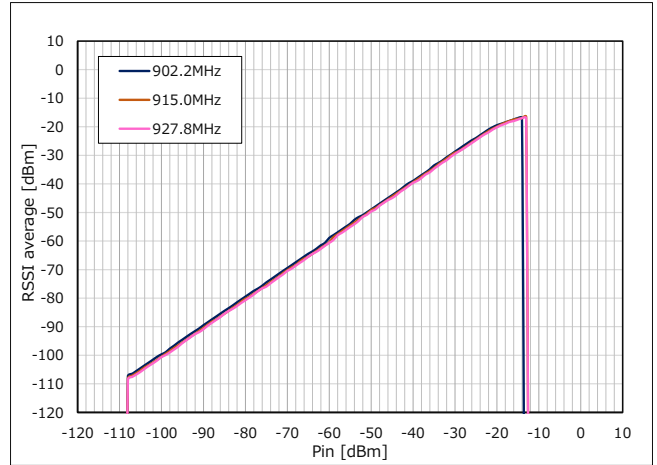
(\*3) Interference signal pattern defined by the certification body. (\*4) Interference signal pattern without LTF and STF defined by Wi-SUN.

(\*5) Interference signal is modulated wave. (\*6) IEEE.802.15.4-2020.

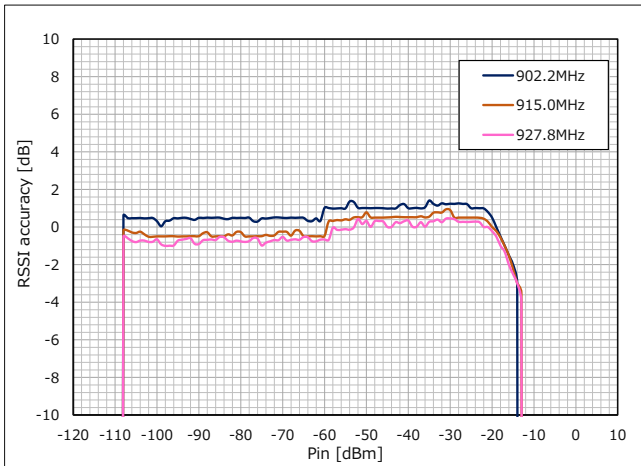
(\*7) Wi-SUN PHY Technical Specification - Amendment 1VA9 (11 Nov 2022).



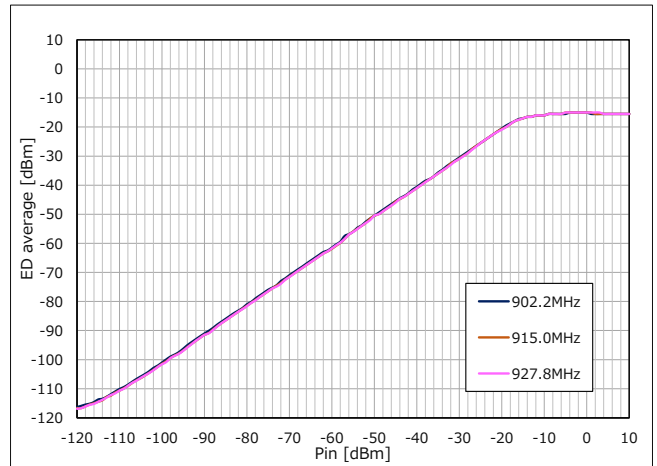
**Figure 113 RF Input Level vs. Packet Error Rate**  
(Frequency = 902.2 / 915.0 / 927.8MHz)



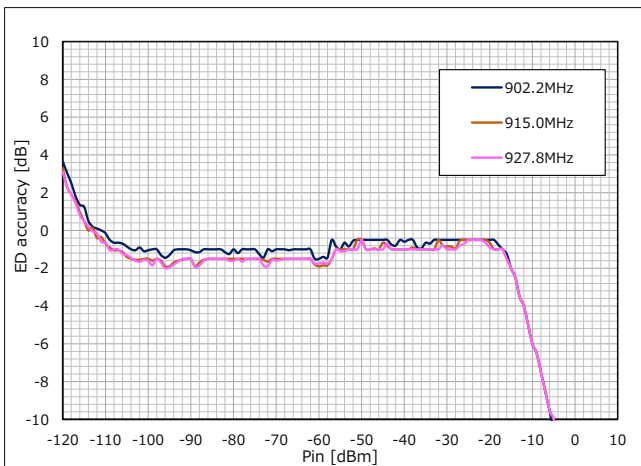
**Figure 114 RF Input Level vs. RSSI average**  
(Frequency = 902.2 / 915.0 / 927.8MHz)



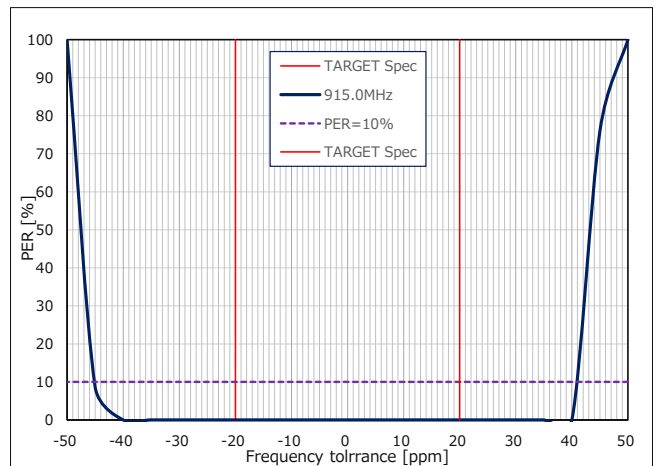
**Figure 115 RF Input Level vs. RSSI accuracy**  
(Frequency = 902.2 / 915.0 / 927.8MHz)



**Figure 116 RF Input Level vs. ED average**  
(Frequency = 902.2 / 915.0 / 927.8MHz)



**Figure 117 RF Input Level vs. ED accuracy**  
(Frequency = 902.2 / 915.0 / 927.8MHz)



**Figure 118 RF Frequency tolerance vs. Packet Error Rate**  
(Frequency = 915.0MHz)

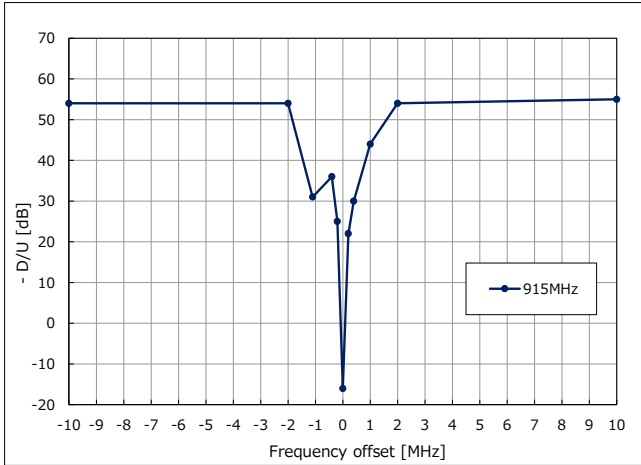


Figure 119 RF Frequency offset vs. Desire/Unwanted Signal Ratio (Frequency = 915.0MHz)

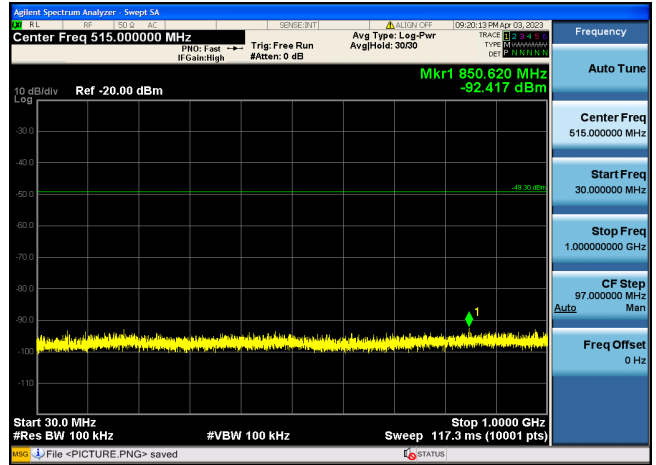


Figure 120 Receiver spurious emission (30MHz -1GHz) (Frequency = 915.0MHz)

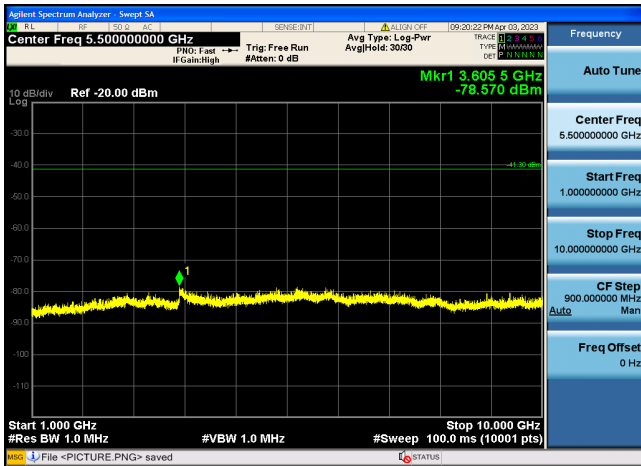


Figure 121 Receiver spurious emission (1GHz -10GHz) (Frequency = 915.0MHz)

### 3. Characteristics of FHSS operation

#### 3.1 FSK

This chapter describes typical characteristics of FHSS operation.

The signal conditions used for measurement are shown below.

Preamble=8byte, Data Length=20byte, Transmit Interval=2ms, Channel switching=random.

Frequency=915MHz (50kbps) / 915.2MHz (150kbps)

**Table 28 Characteristics of FHSS operation**

Items		Unit	Result	Spec
20dB Bandwidth	50kbps	kHz	91.7	< 250
	150kbps		187.3	
Carrier Frequency Separation	50kbps	kHz	200	≥ 20dB Bandwidth
	150kbps		400	
Number of Hopping Frequencies	50kbps	ch	129	≥ 50
	150kbps		64	
Average Time of Occupancy	50kbps	ms	126.7	≤ 400 @ 20s
	150kbps		107.3	

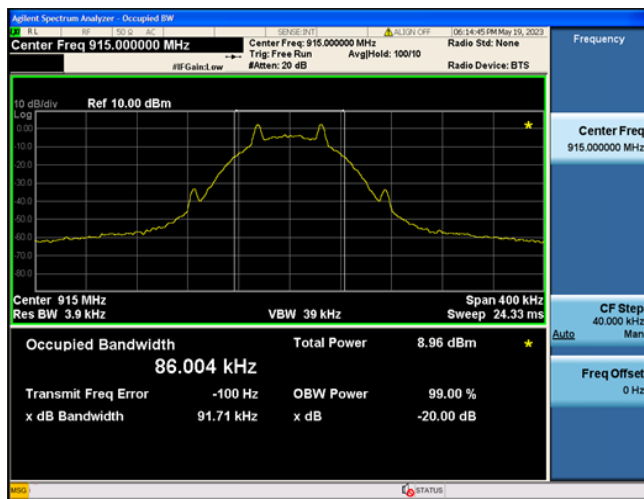


Figure 122 20dB Bandwidth (50kbps)

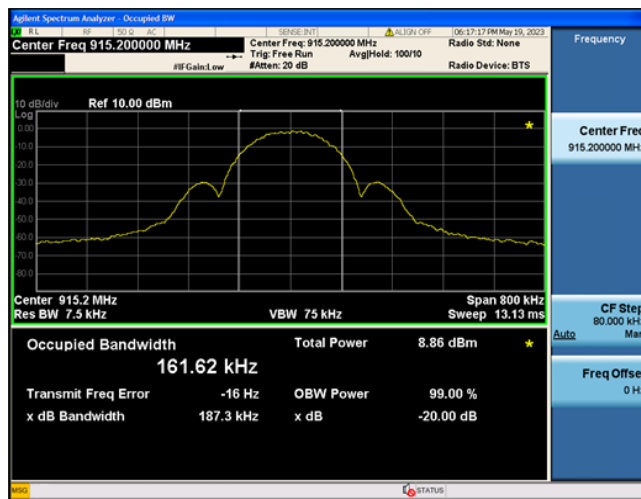


Figure 123 20dB Bandwidth (150kbps)

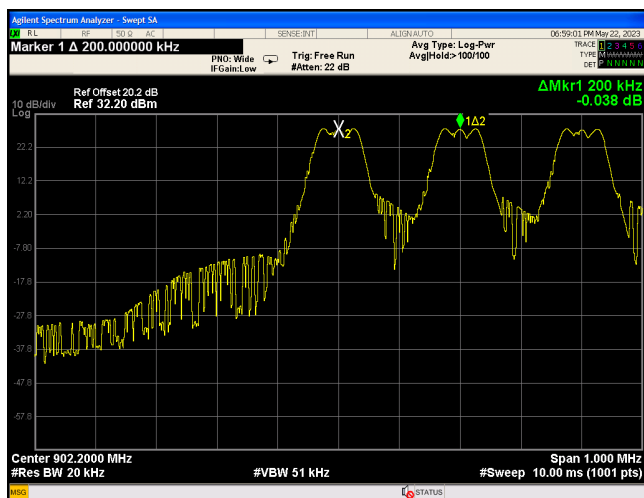


Figure 124 Carrier Frequency Separation (50kbps)

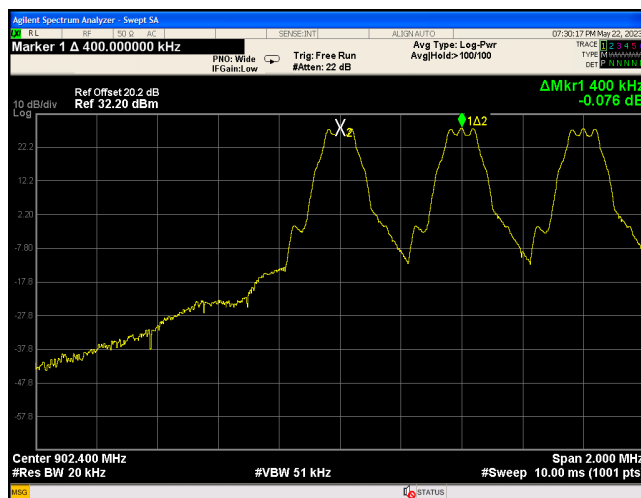


Figure 125 Carrier Frequency Separation (150kbps)

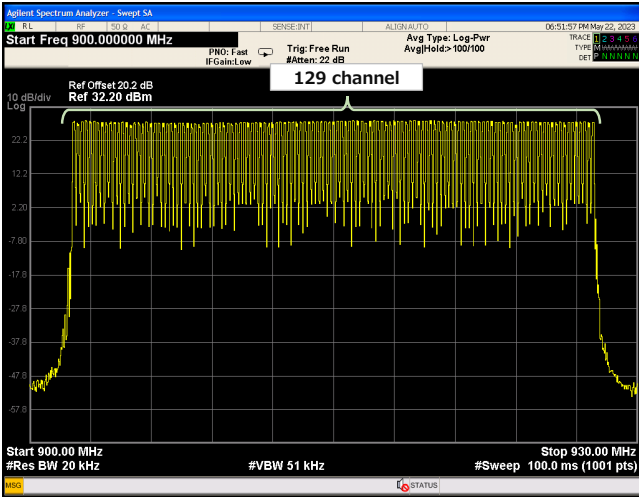


Figure 126 Number of Hopping Frequency (50kbps)

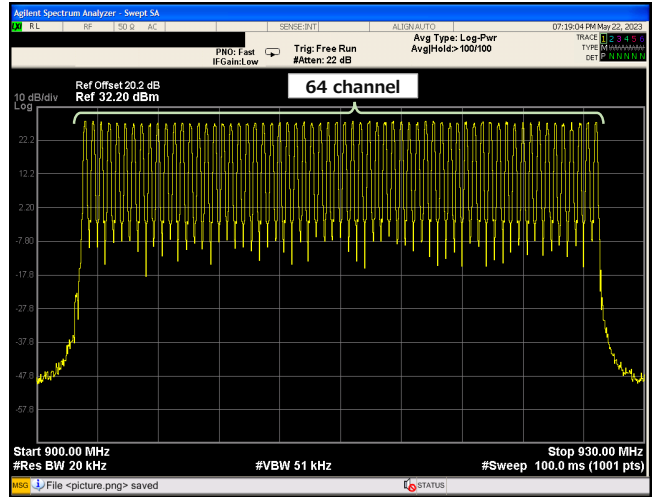


Figure 127 Number of Hopping Frequency (150kbps)

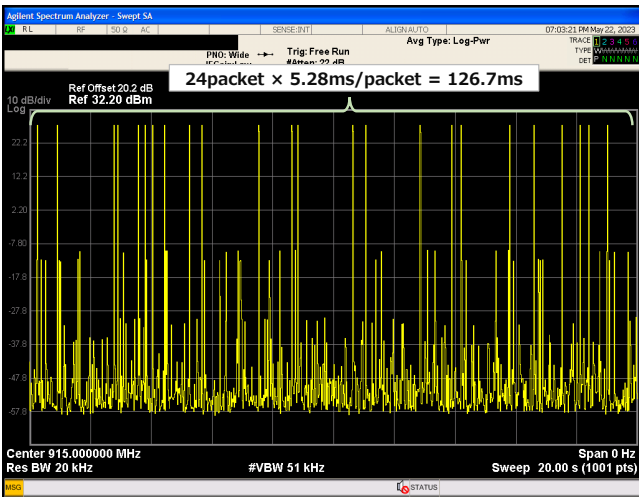


Figure 128 Average Time of Occupancy (50kbps)

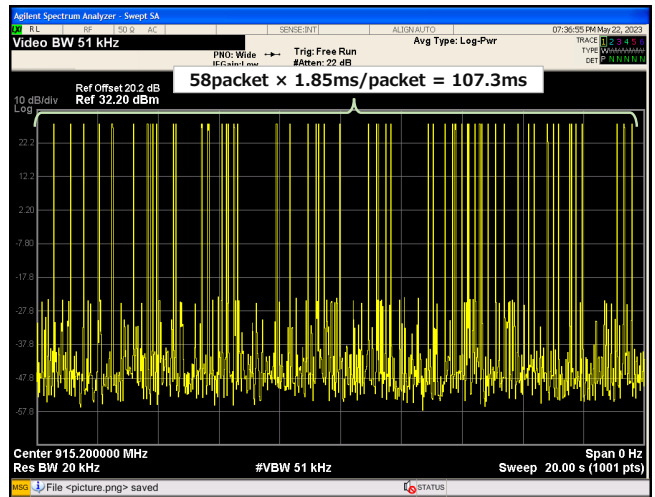


Figure 129 Average Time of Occupancy (150kbps)

### 3.2 OFDM

This chapter describes typical characteristics of FHSS operation.

The signal conditions used for measurement are shown below.

STF=4symbols (default), LTF=2symbols (fixed), Data Length=20byte (default), Transmit Interval=2ms (default), Channel switching=random.

Frequency=915.2MHz (Option3 MCS6) / 915MHz (Option4 MCS6)

**Table 29 Characteristics of FHSS operation**

Items	Unit	Result	Spec
20dB Bandwidth	Option3 MCS6	274.8	< 500
	Option4 MCS6	159.1	< 250
Carrier Frequency Separation	Option3 MCS6	400	≥ 20dB Bandwidth
	Option4 MCS6	200	
Number of Hopping Frequencies	Option3 MCS6	64	≥ 25
	Option4 MCS6	129	≥ 50
Average Time of Occupancy	Option3 MCS6	73	≤ 400 @ 10s
	Option4 MCS6	73.1	≤ 400 @ 20s

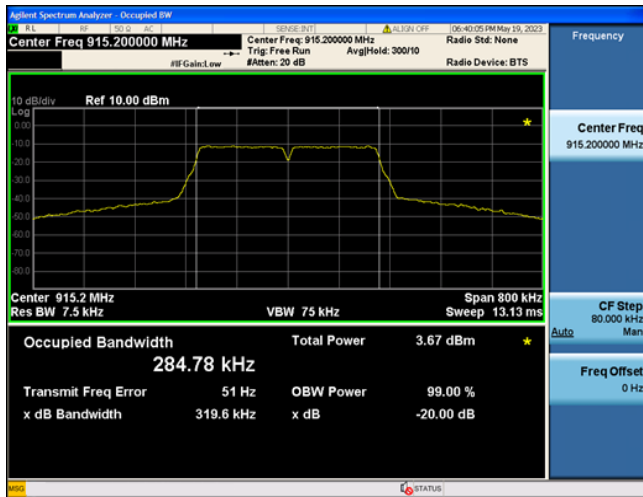


Figure 130 20dB Bandwidth (Option3 MCS6)

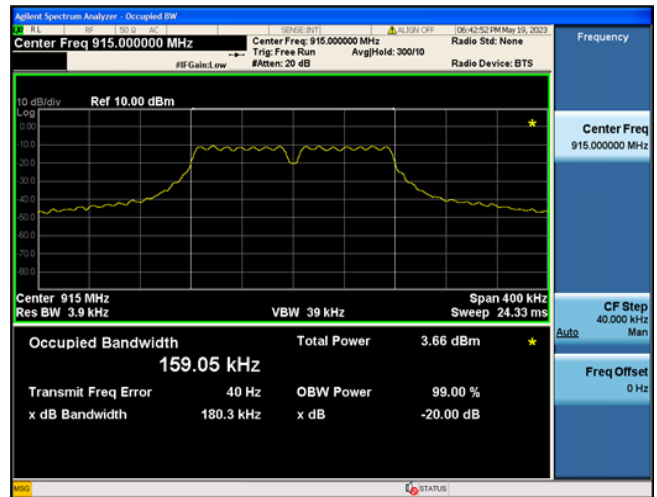


Figure 131 20dB Bandwidth (Option4 MCS6)

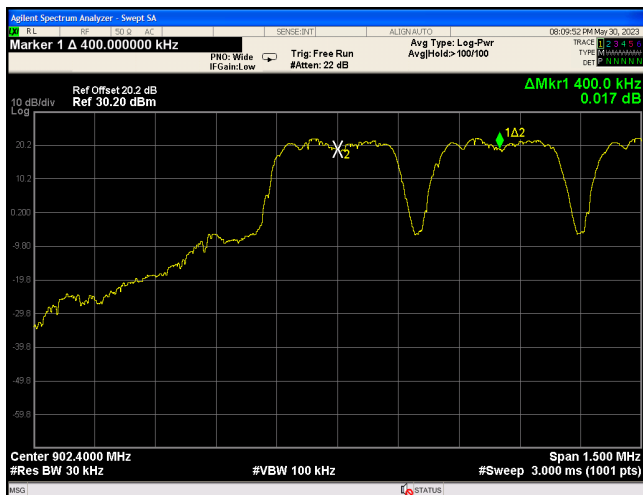


Figure 132 Carrier Frequency Separation (Option3 MCS6)

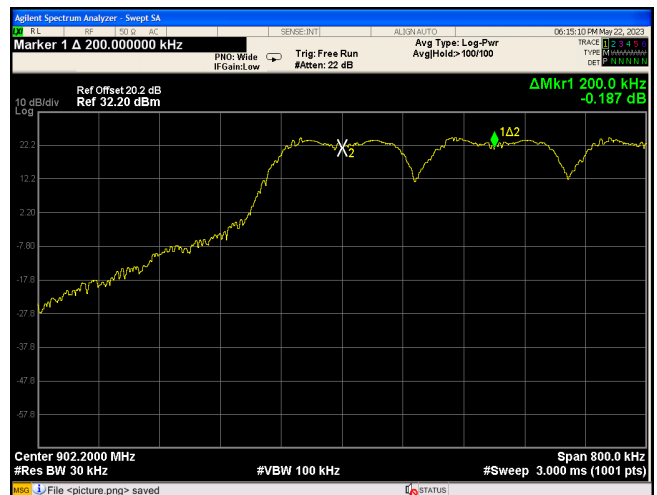


Figure 133 Carrier Frequency Separation (Option4 MCS6)

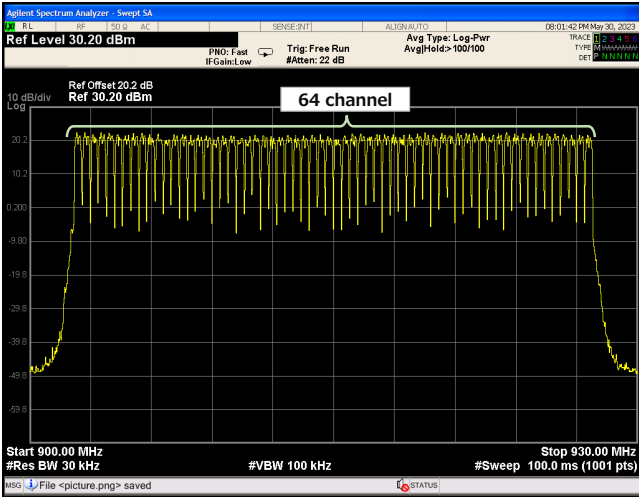


Figure 134 Number of Hopping Frequency (Option3 MCS6)

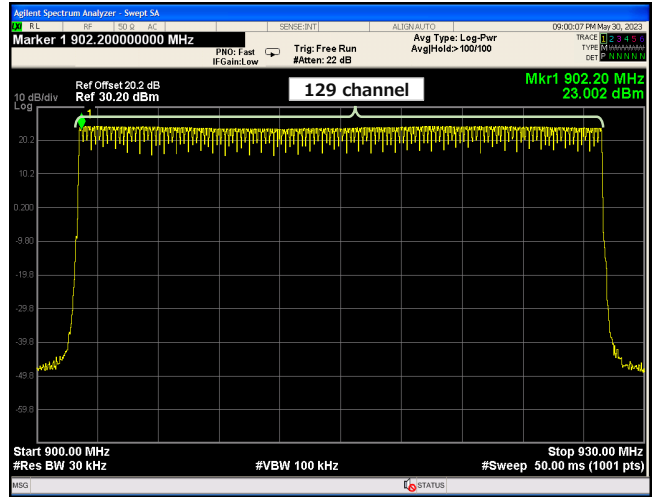


Figure 135 Number of Hopping Frequency (Option4 MCS6)

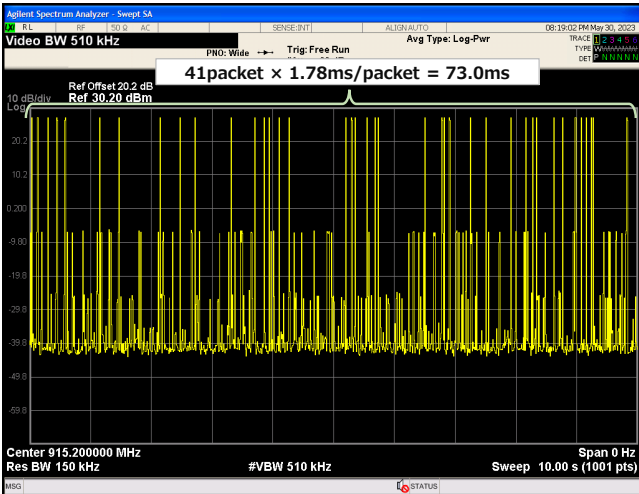


Figure 136 Average Time of Occupancy (Option3 MCS6)

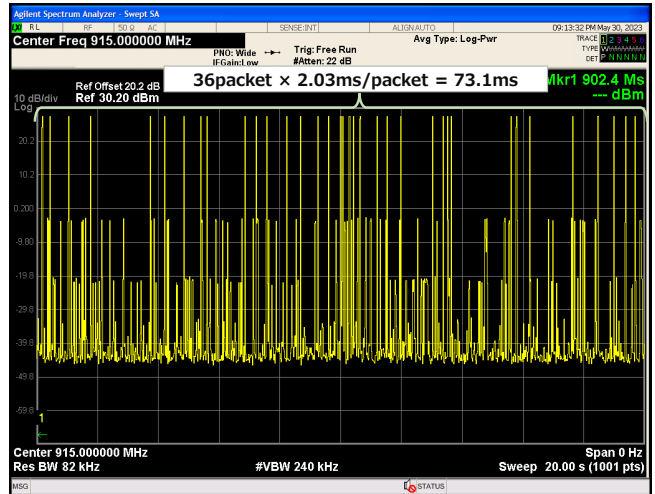


Figure 137 Average Time of Occupancy (Option4 MCS6)



#### 4. Detailed information on the Evaluation Kit

The user's manual and design data for the Evaluation Kit can be viewed at the following URL.

##### **RTK0EE0013D10001BJ**

<https://www.renesas.com/us/en/products/wireless-connectivity/sub-ghz-wi-sun-transceivers/rtk0ee0013d10001bj-r9a06g062gnp-fcc-compliant-sub-ghz-wireless-communication-evaluation-kit>

**Revision History**

Rev.	Date	Description	
		Page	Summary
1.00	Jun.23.2023	-	First edition issued

## General Precautions in the Handling of Microprocessing Unit and Microcontroller Unit Products

The following usage notes are applicable to all Microprocessing unit and Microcontroller unit products from Renesas. For detailed usage notes on the products covered by this document, refer to the relevant sections of the document as well as any technical updates that have been issued for the products.

### 1. Precaution against Electrostatic Discharge (ESD)

A strong electrical field, when exposed to a CMOS device, can cause destruction of the gate oxide and ultimately degrade the device operation. Steps must be taken to stop the generation of static electricity as much as possible, and quickly dissipate it when it occurs. Environmental control must be adequate. When it is dry, a humidifier should be used. This is recommended to avoid using insulators that can easily build up static electricity.

Semiconductor devices must be stored and transported in an anti-static container, static shielding bag or conductive material. All test and measurement tools including work benches and floors must be grounded. The operator must also be grounded using a wrist strap. Semiconductor devices must not be touched with bare hands. Similar precautions must be taken for printed circuit boards with mounted semiconductor devices.

### 2. Processing at power-on

The state of the product is undefined at the time when power is supplied. The states of internal circuits in the LSI are indeterminate and the states of register settings and pins are undefined at the time when power is supplied. In a finished product where the reset signal is applied to the external reset pin, the states of pins are not guaranteed from the time when power is supplied until the reset process is completed. In a similar way, the states of pins in a product that is reset by an on-chip power-on reset function are not guaranteed from the time when power is supplied until the power reaches the level at which resetting is specified.

### 3. Input of signal during power-off state

Do not input signals or an I/O pull-up power supply while the device is powered off. The current injection that results from input of such a signal or I/O pull-up power supply may cause malfunction and the abnormal current that passes in the device at this time may cause degradation of internal elements. Follow the guideline for input signal during power-off state as described in your product documentation.

### 4. Handling of unused pins

Handle unused pins in accordance with the directions given under handling of unused pins in the manual. The input pins of CMOS products are generally in the high-impedance state. In operation with an unused pin in the open-circuit state, extra electromagnetic noise is induced in the vicinity of the LSI, an associated shoot-through current flows internally, and malfunctions occur due to the false recognition of the pin state as an input signal become possible.

### 5. Clock signals

After applying a reset, only release the reset line after the operating clock signal becomes stable. When switching the clock signal during program execution, wait until the target clock signal is stabilized. When the clock signal is generated with an external resonator or from an external oscillator during a reset, ensure that the reset line is only released after full stabilization of the clock signal. Additionally, when switching to a clock signal produced with an external resonator or by an external oscillator while program execution is in progress, wait until the target clock signal is stable.

### 6. Voltage application waveform at input pin

Waveform distortion due to input noise or a reflected wave may cause malfunction. If the input of the CMOS device stays in the area between  $V_{IL}$  (Max.) and  $V_{IH}$  (Min.) due to noise, for example, the device may malfunction. Take care to prevent chattering noise from entering the device when the input level is fixed, and also in the transition period when the input level passes through the area between  $V_{IL}$  (Max.) and  $V_{IH}$  (Min.).

### 7. Prohibition of access to reserved addresses

Access to reserved addresses is prohibited. The reserved addresses are provided for possible future expansion of functions. Do not access these addresses as the correct operation of the LSI is not guaranteed.

### 8. Differences between products

Before changing from one product to another, for example to a product with a different part number, confirm that the change will not lead to problems. The characteristics of a microprocessing unit or microcontroller unit products in the same group but having a different part number might differ in terms of internal memory capacity, layout pattern, and other factors, which can affect the ranges of electrical characteristics, such as characteristic values, operating margins, immunity to noise, and amount of radiated noise. When changing to a product with a different part number, implement a system-evaluation test for the given product.

## Notice

1. Descriptions of circuits, software and other related information in this document are provided only to illustrate the operation of semiconductor products and application examples. You are fully responsible for the incorporation or any other use of the circuits, software, and information in the design of your product or system. Renesas Electronics disclaims any and all liability for any losses and damages incurred by you or third parties arising from the use of these circuits, software, or information.
2. Renesas Electronics hereby expressly disclaims any warranties against and liability for infringement or any other claims involving patents, copyrights, or other intellectual property rights of third parties, by or arising from the use of Renesas Electronics products or technical information described in this document, including but not limited to, the product data, drawings, charts, programs, algorithms, and application examples.
3. No license, express, implied or otherwise, is granted hereby under any patents, copyrights or other intellectual property rights of Renesas Electronics or others.
4. You shall be responsible for determining what licenses are required from any third parties, and obtaining such licenses for the lawful import, export, manufacture, sales, utilization, distribution or other disposal of any products incorporating Renesas Electronics products, if required.
5. You shall not alter, modify, copy, or reverse engineer any Renesas Electronics product, whether in whole or in part. Renesas Electronics disclaims any and all liability for any losses or damages incurred by you or third parties arising from such alteration, modification, copying or reverse engineering.
6. Renesas Electronics products are classified according to the following two quality grades: "Standard" and "High Quality". The intended applications for each Renesas Electronics product depends on the product's quality grade, as indicated below.
  - "Standard": Computers; office equipment; communications equipment; test and measurement equipment; audio and visual equipment; home electronic appliances; machine tools; personal electronic equipment; industrial robots; etc.
  - "High Quality": Transportation equipment (automobiles, trains, ships, etc.); traffic control (traffic lights); large-scale communication equipment; key financial terminal systems; safety control equipment; etc.Unless expressly designated as a high reliability product or a product for harsh environments in a Renesas Electronics data sheet or other Renesas Electronics document, Renesas Electronics products are not intended or authorized for use in products or systems that may pose a direct threat to human life or bodily injury (artificial life support devices or systems; surgical implantations; etc.), or may cause serious property damage (space system; undersea repeaters; nuclear power control systems; aircraft control systems; key plant systems; military equipment; etc.). Renesas Electronics disclaims any and all liability for any damages or losses incurred by you or any third parties arising from the use of any Renesas Electronics product that is inconsistent with any Renesas Electronics data sheet, user's manual or other Renesas Electronics document.
7. No semiconductor product is absolutely secure. Notwithstanding any security measures or features that may be implemented in Renesas Electronics hardware or software products, Renesas Electronics shall have absolutely no liability arising out of any vulnerability or security breach, including but not limited to any unauthorized access to or use of a Renesas Electronics product or a system that uses a Renesas Electronics product. RENESAS ELECTRONICS DOES NOT WARRANT OR GUARANTEE THAT RENESAS ELECTRONICS PRODUCTS, OR ANY SYSTEMS CREATED USING RENESAS ELECTRONICS PRODUCTS WILL BE INVULNERABLE OR FREE FROM CORRUPTION, ATTACK, VIRUSES, INTERFERENCE, HACKING, DATA LOSS OR THEFT, OR OTHER SECURITY INTRUSION ("Vulnerability Issues"). RENESAS ELECTRONICS DISCLAIMS ANY AND ALL RESPONSIBILITY OR LIABILITY ARISING FROM OR RELATED TO ANY VULNERABILITY ISSUES. FURTHERMORE, TO THE EXTENT PERMITTED BY APPLICABLE LAW, RENESAS ELECTRONICS DISCLAIMS ANY AND ALL WARRANTIES, EXPRESS OR IMPLIED, WITH RESPECT TO THIS DOCUMENT AND ANY RELATED OR ACCOMPANYING SOFTWARE OR HARDWARE, INCLUDING BUT NOT LIMITED TO THE IMPLIED WARRANTIES OF MERCHANTABILITY, OR FITNESS FOR A PARTICULAR PURPOSE.
8. When using Renesas Electronics products, refer to the latest product information (data sheets, user's manuals, application notes, "General Notes for Handling and Using Semiconductor Devices" in the reliability handbook, etc.), and ensure that usage conditions are within the ranges specified by Renesas Electronics with respect to maximum ratings, operating power supply voltage range, heat dissipation characteristics, installation, etc. Renesas Electronics disclaims any and all liability for any malfunctions, failure or accident arising out of the use of Renesas Electronics products outside of such specified ranges.
9. Although Renesas Electronics endeavors to improve the quality and reliability of Renesas Electronics products, semiconductor products have specific characteristics, such as the occurrence of failure at a certain rate and malfunctions under certain use conditions. Unless designated as a high reliability product or a product for harsh environments in a Renesas Electronics data sheet or other Renesas Electronics document, Renesas Electronics products are not subject to radiation resistance design. You are responsible for implementing safety measures to guard against the possibility of bodily injury, injury or damage caused by fire, and/or danger to the public in the event of a failure or malfunction of Renesas Electronics products, such as safety design for hardware and software, including but not limited to redundancy, fire control and malfunction prevention, appropriate treatment for aging degradation or any other appropriate measures. Because the evaluation of microcomputer software alone is very difficult and impractical, you are responsible for evaluating the safety of the final products or systems manufactured by you.
10. Please contact a Renesas Electronics sales office for details as to environmental matters such as the environmental compatibility of each Renesas Electronics product. You are responsible for carefully and sufficiently investigating applicable laws and regulations that regulate the inclusion or use of controlled substances, including without limitation, the EU RoHS Directive, and using Renesas Electronics products in compliance with all these applicable laws and regulations. Renesas Electronics disclaims any and all liability for damages or losses occurring as a result of your noncompliance with applicable laws and regulations.
11. Renesas Electronics products and technologies shall not be used for or incorporated into any products or systems whose manufacture, use, or sale is prohibited under any applicable domestic or foreign laws or regulations. You shall comply with any applicable export control laws and regulations promulgated and administered by the governments of any countries asserting jurisdiction over the parties or transactions.
12. It is the responsibility of the buyer or distributor of Renesas Electronics products, or any other party who distributes, disposes of, or otherwise sells or transfers the product to a third party, to notify such third party in advance of the contents and conditions set forth in this document.
13. This document shall not be reprinted, reproduced or duplicated in any form, in whole or in part, without prior written consent of Renesas Electronics.
14. Please contact a Renesas Electronics sales office if you have any questions regarding the information contained in this document or Renesas Electronics products.

(Note1) "Renesas Electronics" as used in this document means Renesas Electronics Corporation and also includes its directly or indirectly controlled subsidiaries.

(Note2) "Renesas Electronics product(s)" means any product developed or manufactured by or for Renesas Electronics.

(Rev.5.0-1 October 2020)

## Corporate Headquarters

TOYOSU FORESIA, 3-2-24 Toyosu,  
Koto-ku, Tokyo 135-0061, Japan

[www.renesas.com](http://www.renesas.com)

## Trademarks

Renesas and the Renesas logo are trademarks of Renesas Electronics Corporation. All trademarks and registered trademarks are the property of their respective owners.

## Contact information

For further information on a product, technology, the most up-to-date version of a document, or your nearest sales office, please visit:

[www.renesas.com/contact/](http://www.renesas.com/contact/).