

## RX65N Group

### Sample Code for OTA Update of a Secondary Device by Amazon Web Services with the Use of FreeRTOS

#### Introduction

This application note is for a system in which an RX65N microcontroller is used as a primary MCU that communicates with Amazon Web Services™ (hereafter, referred to as “AWS”) and an RX microcontroller is used as a secondary MCU that receives data measured by sensors. This application note describes a demonstration where AWS services are used to perform an over-the-air (OTA) update of the secondary MCU (hereafter, referred to as “secondary OTA update”).

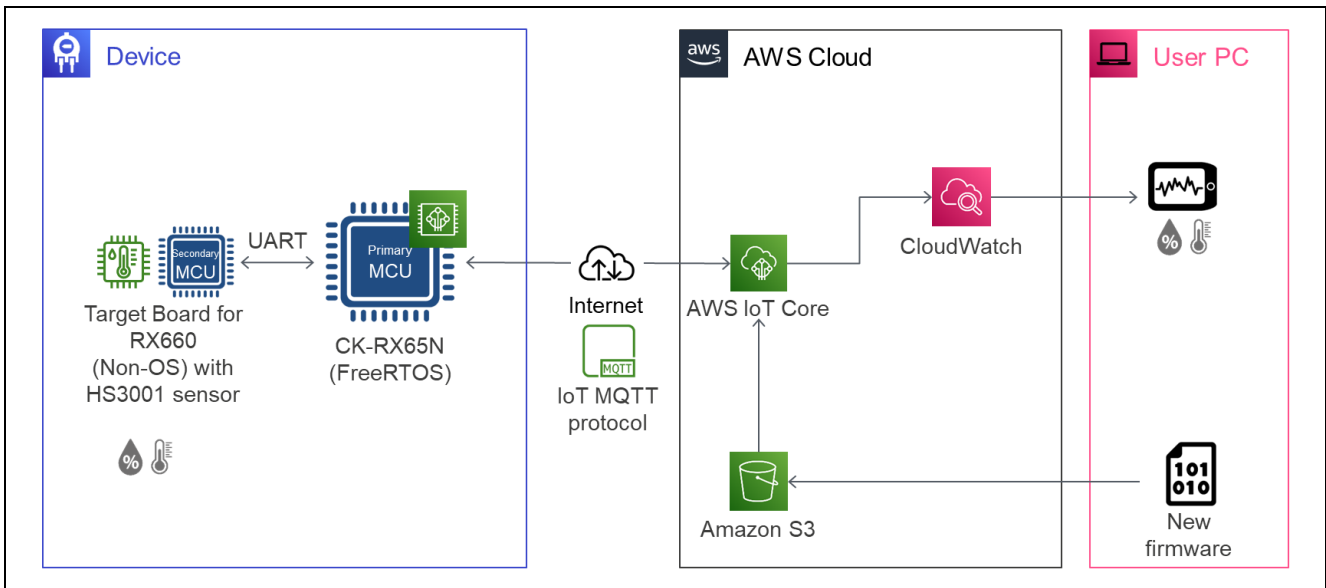

#### Devices Used in Confirming Operation

- Primary MCU: RX65N
- Secondary MCU: RX660
- Temperature and humidity sensor: HS3001 high-performance relative humidity and temperature sensor

#### Boards Used in Confirming Operation

- Primary MCU: CK-RX65N (RTK5CK65N0S04000BE)
- Secondary MCU: Target Board for RX660 (RTK5RX6600C00000BJ)
- Temperature and humidity sensor: Relative Humidity Sensor Pmod™ Board (US082-HS3001EVZ)

## Related Documents

This application note refers to and further explains information in the following documents. Updating of a document may lead to changes to the structure of chapters and other items. Take care on this point when referring to the following documents.

[RX Family Firmware Update Module Using Firmware Integration Technology \(R01AN6850\)](#)

[RX Family Firmware Update Software Development Guide using AWS/Azure QE for OTA \(R20AN0712\)](#)

[RX Family How to implement FreeRTOS OTA using Amazon Web Services in RX65N \(for v202210.01-LTS-rx-1.1.0 or later\)](#)

[RX65N Group CK-RX65N v1 User's Manual \(R20UT5100\)](#)

[RX660 Group Target Board for RX660 User's Manual \(R20UT5068\)](#)

(Download the latest versions from the Renesas Electronics Corp. website.)

Technical Updates and Technical News

(Download the latest versions from the Renesas Electronics Corp. website.)

Amazon Web Services, the "Powered by AWS" logo, and any other AWS trademarks used in such materials are trademarks of Amazon.com, Inc. or its affiliates in the United States and/or other countries.

FreeRTOS™ and FreeRTOS.org™ are trademarks of Amazon Web Services, Inc.

Pmod is a trademark of Digilent Inc.

All trademarks and registered trademarks are the property of their respective owners.

## Contents

1. Overview .....	5
2. Conditions for Confirming Operation .....	5
3. Description of Hardware .....	6
4. Description of Software.....	7
4.1 Firmware Update Methods .....	7
4.2 UART Communications between the Microcontrollers.....	9
4.2.1 Settings of UART Communications .....	9
4.2.2 Data Format.....	10
4.2.2.1 Data Format of a Whole Packet .....	10
4.2.2.2 Data Format of a Payload .....	11
4.2.3 Command Specifications.....	12
4.2.3.1 FWUP Commands .....	12
4.2.3.2 SENSOR Command.....	14
4.3 Folder/File Structure .....	15
4.4 Code Size .....	16
5. Operations of the Demonstration .....	17
6. Setting up the Demonstration .....	17
6.1 Setting up the Hardware.....	17
6.1.1 Setting up the CK-RX65N .....	18
6.1.2 Setting up the TB-RX660 .....	20
6.2 Setting up the Software .....	24
6.2.1 Advance Preparation.....	24
6.2.2 Setting the Terminal Software .....	24
6.2.3 Creating and Running the Initial Firmware for the CK-RX65N.....	25
6.2.4 Creating and Running the Initial Firmware for the TB-RX660.....	29
6.3 Preparations for Using the AWS Cloud.....	31
6.3.1 Settings for the OTA Update .....	31
6.3.2 Settings for Displaying the Sensor Data .....	32
6.3.2.1 Setting up Amazon CloudWatch .....	33
7. Procedure for Running the Demonstration.....	39
7.1 Checking the Initial State of Operation.....	39
7.2 Executing the OTA Update of the TB-RX660.....	41
7.2.1 Creating the Update Firmware .....	41
7.2.2 Creating an OTA Job in AWS.....	42
7.2.3 Checking Operation during Execution of the Secondary OTA Update .....	47
7.3 Checking Operation after the OTA Update .....	48

8. Precautions .....	50
8.1 License Information on the Open-Source Software in Use .....	50
8.2 Region and User Privileges of AWS for the Demonstration.....	50
8.3 Fees for Using AWS.....	50
Revision History.....	51

## 1. Overview

This demonstration involves using a secondary OTA update to add a working sensor and confirming addition of the sensor data to be acquired by the display of sensor data in an AWS display in your browser.

IoT devices require the appropriate fixing of security vulnerabilities and updating of functions in response to customer requests. Implementing the secondary OTA update to supplement OTA updating of the primary MCU that has been provided in the past enables product development that supports measures against vulnerabilities in the secondary MCU and the updating of flexible services.

## 2. Conditions for Confirming Operation

The sample demonstration programs for this application note have been confirmed to operate correctly under the following conditions.

**Table 2-1 Conditions for Confirming Demo Operation (RX65N)**

Item	Description
MCU	<a href="#">RX65N (R5F565NEHDFB)</a>
Board	<a href="#">CK-RX65N (RTK5CK65N0S04000BE)</a>
Operating voltage	3.3 V
RTOS	<a href="#">FreeRTOS v202210.01-LTS-1.1.3</a>
Integrated development environment (IDE)	<a href="#">e<sup>2</sup> studio 2024-01 (24.1.0)</a> <a href="#">QE for OTA v2.00</a>
C compiler	<a href="#">C/C++ Compiler Package for RX Family [CC-RX] v3.06.00</a> made by Renesas Electronics Corporation
Flash memory programming tool	<a href="#">Renesas Flash Programmer V3.14.00</a>

**Table 2-2 Conditions for Confirming Demo Operation (RX660)**

Item	Description
MCU	<a href="#">RX660 (R5F56609BDFP)</a>
Board	<a href="#">Target Board for RX660 (RTK5RX6600C00000BJ)</a>
Operating voltage	3.3 V
Integrated development environment (IDE)	<a href="#">e<sup>2</sup> studio 2024-01 (24.1.0)</a>
C compiler	<a href="#">C/C++ Compiler Package for RX Family [CC-RX] v3.06.00</a> made by Renesas Electronics Corporation GCC for Renesas RX 8.3.0.202202
Flash memory programming tool	<a href="#">Renesas Flash Programmer V3.14.00</a>
MOT file conversion tool	Renesas Image Generator (included in the RX660 project)
USB-UART converter	<a href="#">Pmod USBUART™</a>

**Table 2-3 Condition for Confirming Demo Operation (Sensor)**

Item	Description
Temperature and humidity sensor board	<a href="#">US082-HS3001EVZ board</a>

**Table 2-4 Condition for Confirming Demo Operation (Others)**

Item	Version
<a href="#">Python</a>	3.10.4

QE for OTA is available at <https://www.renesas.com/qe-ota/>.

Python is available at <https://www.python.org/>.

### 3. Description of Hardware

The system consists of an RX65N microcontroller (primary MCU) that provides functionality for controlling communications with AWS and an RX660 microcontroller (secondary MCU) connected to the HS3001 sensor. The two microcontrollers communicate with each other via UARTs.

The system configuration is shown in Figure 3-1.

The CK-RX65N equipped with an RX65N microcontroller is used as the primary MCU.

The Target Board for RX660 (hereafter referred to as “TB-RX660”) equipped with an RX660 microcontroller is used as the secondary MCU.

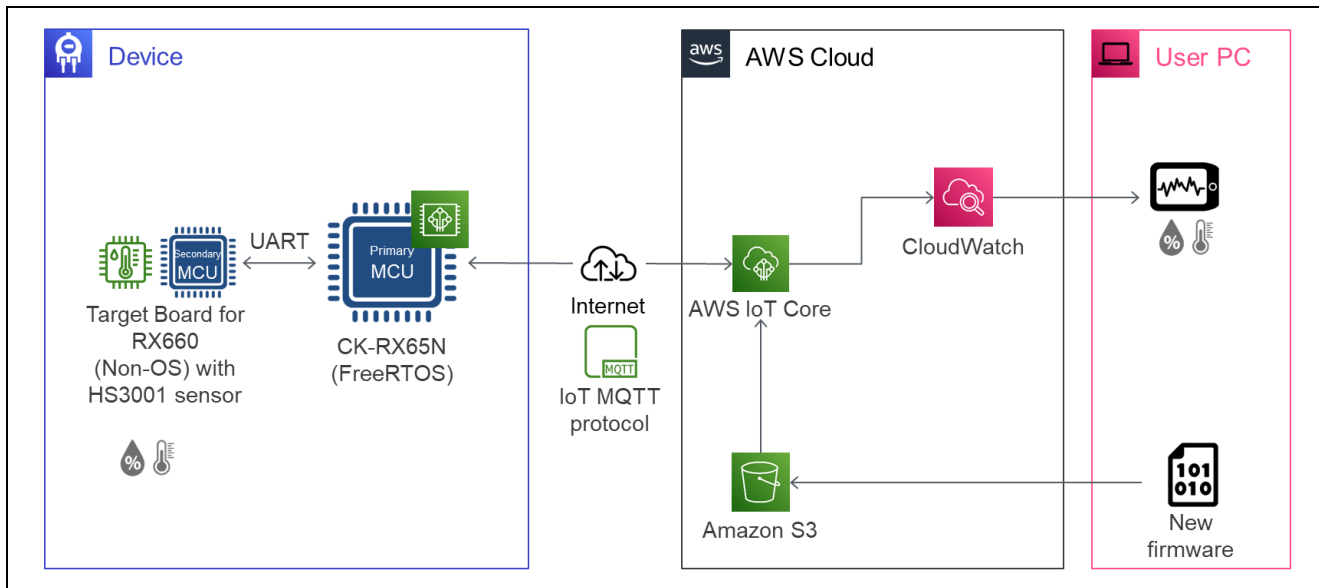

Figure 3-1 System Configuration of This Demo

## 4. Description of Software

“FreeRTOS™ with IoT Library” is implemented in the RX65N firmware, which utilizes AWS-certified programs. This allows the use of AWS IoT Core and AWS IoT Device Management, which are managed services provided by AWS, to perform OTA firmware updating and data uploading to the cloud via MQTT communications.

The RX65N microcontroller on the primary MCU side uses the AWS IoT Over-the-air Update Library to control OTA updating of the secondary MCU. The update firmware for the secondary MCU, which is received from AWS, is transferred to the secondary MCU, where the firmware update is applied.

The RX microcontroller on the secondary MCU side uses “[RX Family Firmware Update Module Using Firmware Integration Technology Rev.2.01](#)” to control firmware updating of the secondary MCU.

### 4.1 Firmware Update Methods

The mechanism for firmware update in the secondary MCU of this sample program uses “linear mode partial update method” among the methods provided by the firmware update module. For details on this method, refer to “linear mode partial update method” in “1.3 Firmware Update Operation” in “[RX Family Firmware Update Module Using Firmware Integration Technology Rev.2.01](#)”.

The memory map of this sample program is shown in the following.

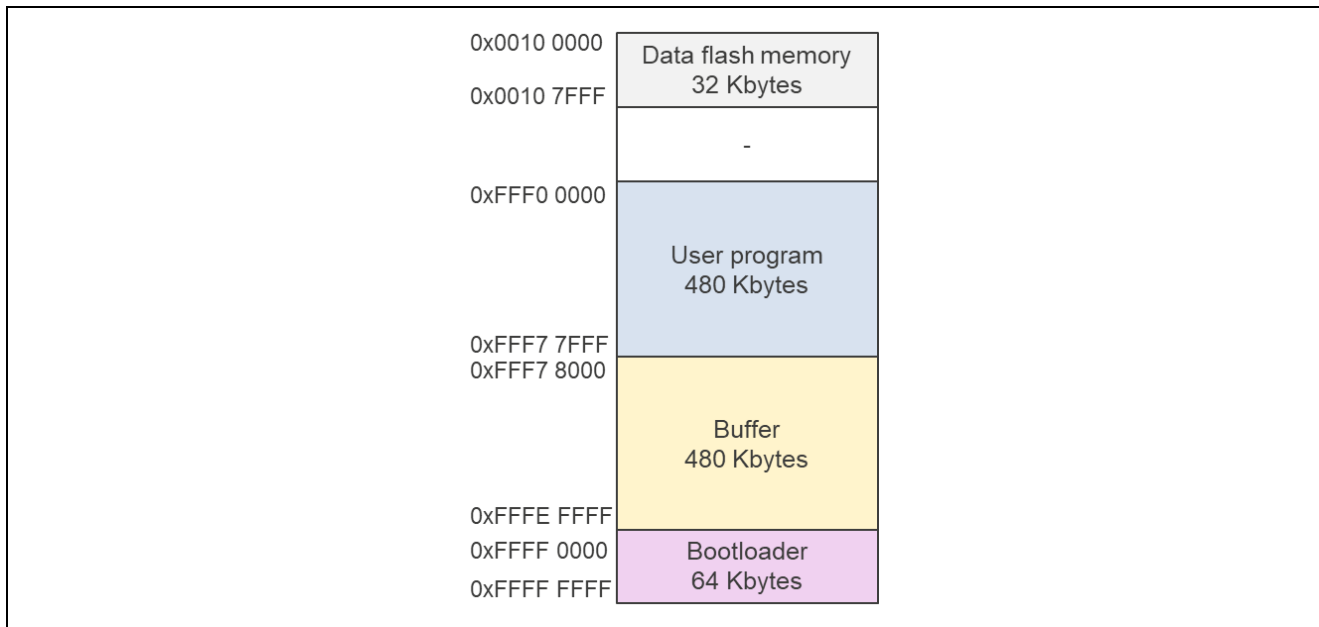

Figure 4-1 Memory Map of the TB-RX660 Sample Program

Operations for the secondary OTA update are summarized in Figure 4-2. The states of the ROM in each phase during updating are shown in Figure 4-3. Note that the red frames in Figure 4-3 indicate the programs under execution at the given times.

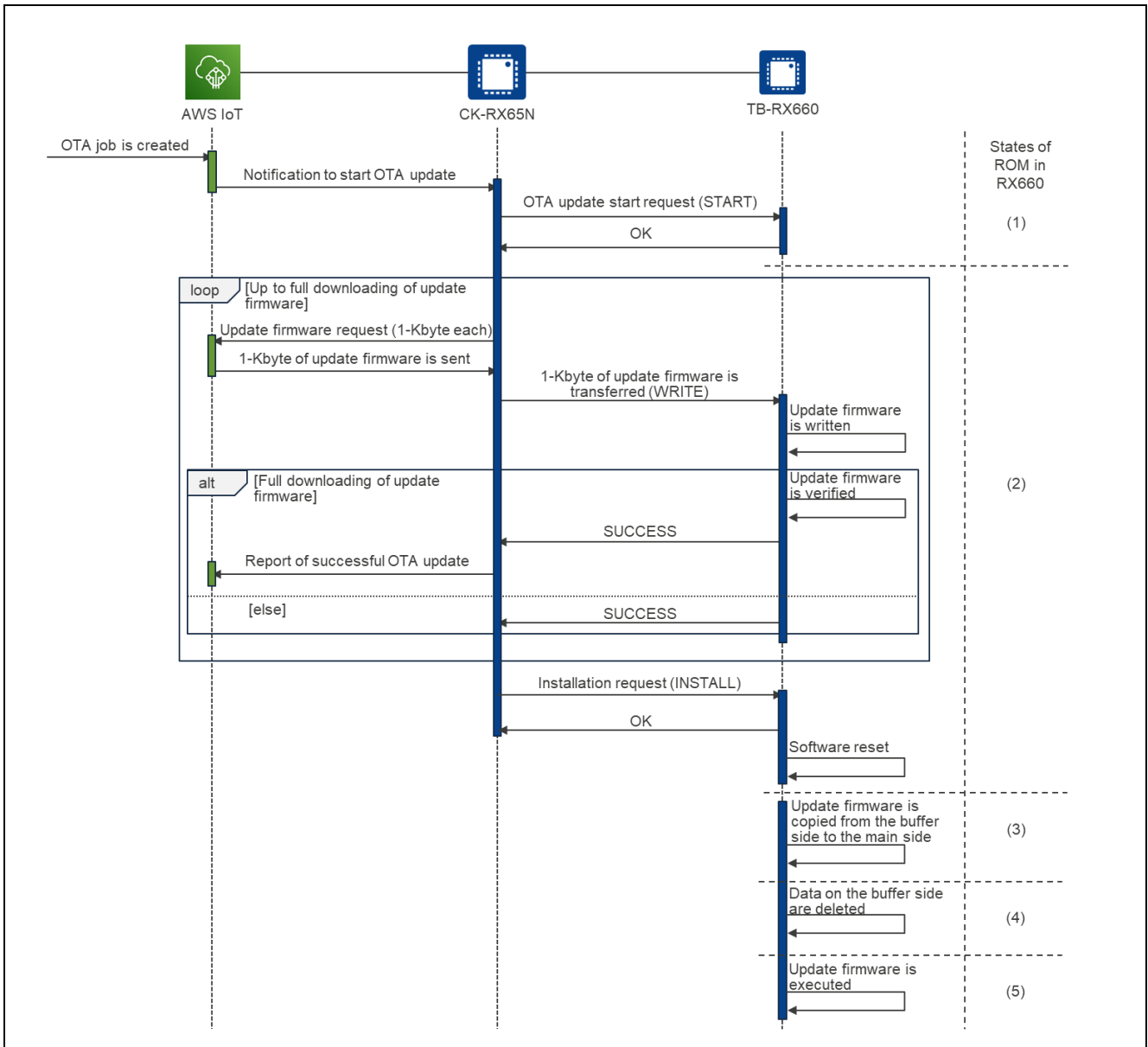

Figure 4-2 Overview of Operations for the Secondary OTA Update

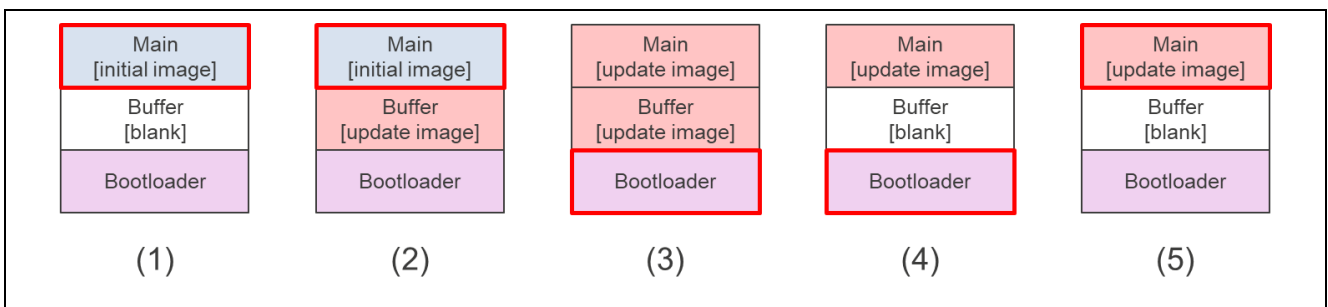

Figure 4-3 States of ROM in the Secondary MCU during Updating



## 4.2 UART Communications between the Microcontrollers

The primary MCU transmits a command to the secondary MCU via UART communications, and the secondary MCU executes the processing directed by the received command and returns the result as a response.

### 4.2.1 Settings of UART Communications

The UART communications settings are shown in Table 4-1.

**Table 4-1 Settings of UART Communications between the Microcontrollers**

Item	Setting
Baud rate	1 Mbps or less (speed used in confirming operation)
Data length	8 bits
Parity bit	None
Stop bit	1 bit
Flow control	None

## 4.2.2 Data Format

The specifications for packet communications of commands or responses between the primary MCU and secondary MCU are described here.

### 4.2.2.1 Data Format of a Whole Packet

Figure 4-4 shows the data format of a whole packet. A packet consists of a header and a payload.

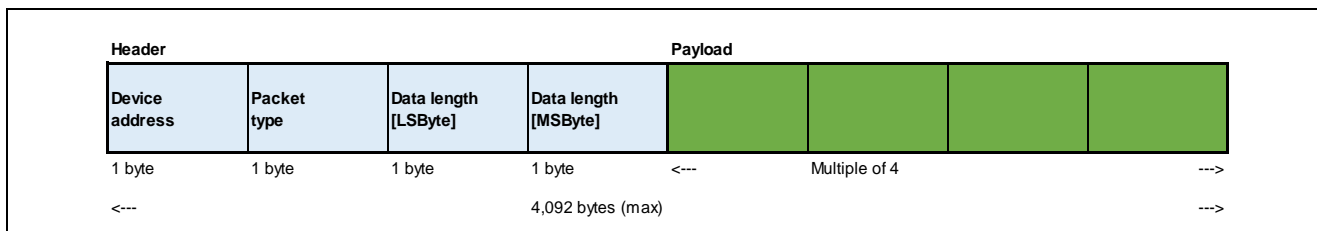

Figure 4-4 Data Format of a Whole Packet

The header specifications for a packet are listed in Table 4-2.

Table 4-2 Header Specifications for a Packet

Item	Description
Device address	Device address Each device refers to the device address to determine whether the address is its own. When the secondary MCU determines that a packet is addressed to itself, it starts detailed analysis of the packet. <ul style="list-style-type: none"> <li>• 0x00: Device address of the primary MCU</li> <li>• 0x01 to 0xFE: Device address of the secondary MCU</li> <li>• 0xFF: Reserved</li> </ul>
Packet type	Packet attribute <ul style="list-style-type: none"> <li>• b7 and b6: Fixed to 00b</li> <li>• b5: 0: Request, 1: Response</li> <li>• b4: [Request] Fixed to 0 [Response] 0: ACK, 1: NACK*</li> <li>• b3 to b0: Command type 0000b: Common command 0001b: Reserved 0010b: FWUP command 0011b: SENSOR command 0100b to 1111b: Reserved</li> </ul>
Data length	Data size of the payload

Note: ACK or NACK indicates whether the data format of the packet was normal or abnormal, respectively.

### 4.2.2.2 Data Format of a Payload

Figure 4-5 shows the data format of a payload. A payload consists of a command header and command data.

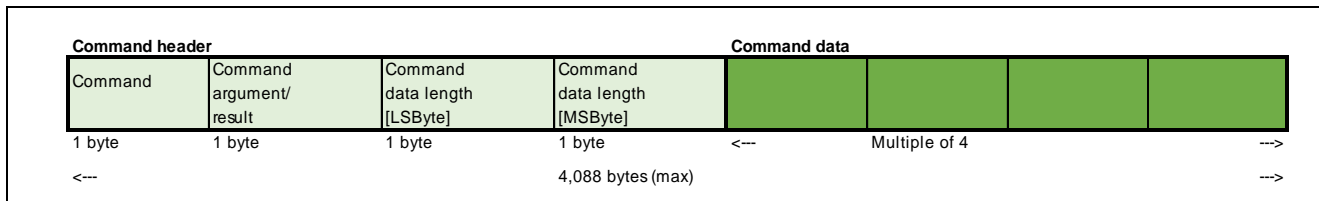

Figure 4-5 Data Format of a Payload

The specifications for a command header are listed in Table 4-3.

Table 4-3 Specifications for a Command Header

Item	Description
Command	Command For details, refer to “0 Command Specifications”.
Command argument/result	<p>In the case of a request, this is an argument for the command.</p> <ul style="list-style-type: none"> <li>• b7 to b4: Fixed to 0000b</li> <li>• b3: Reserved as 0b.</li> <li>• b2: Reserved as 0b.</li> <li>• b1 and b0: Argument 00: Secondary MCU 0 01: Primary MCU 0 10: Primary MCU 1 11: Primary MCU 2</li> </ul> <p>In the case of a response, this is the result of executing the command.</p> <ul style="list-style-type: none"> <li>• b7 to b4: 1111: Failure of command execution 1110: Invalid command header (non-supported command) ... 0001: Successful completion of command execution 1 0000: Successful completion of command execution</li> <li>• b3: Reserved as 0b. Same as for a request.</li> <li>• b2: Reserved as 0b. Same as for a request.</li> <li>• b1 and b0: Argument. Same as for a request.</li> </ul>
Command data length	Data size of the command data. This should be set to a multiple of 4.

### 4.2.3 Command Specifications

#### 4.2.3.1 FWUP Commands

These commands are used at the time of updating firmware. Table 4-4 shows a list of the FWUP commands.

**Table 4-4 List of FWUP Commands**

Command Type	Command	Description
FWUP	START: Firmware update start command	Starts updating of the firmware.
	WRITE: Firmware write command	Writes the update firmware.
	INSTALL: Firmware install command	Installs and executes the update firmware.
	CANCEL: Firmware update cancel command	Aborts updating of the firmware.

##### (1) START: Firmware update start command

This command requests starting of the firmware update. Target ID can be set to a desired value. This command can be used in the identification code, etc. on the user side.

The secondary MCU sets the result in the command argument/result field and returns the response.

Place the secondary MCU in a state in which the update firmware can be written by using the firmware update module.

**Table 4-5 Data Format of the FWUP/START Command**

Command	Packet	Device Address	Packet Type	Data Length		Command	Command Argument/Result	Command Data Length		Command Data			
				LSB	MSB			LSB	MSB	0	1	2	3
FWUP/START	Request	0xXX	0x02	0x08	0x00	0x02	0x00	0x04	0x00	Target ID [little endian]			
	ACK response		0x22	0x04	*		0x00						

Note: The possible result values for a response are listed below.

0x00: Successful operation

0xFF: Failed operation

##### (2) WRITE: Firmware write command

This command transmits an offset address based on the start address of binary data having an offset value of 0 and its firmware data, and requests writing of the firmware data.

The secondary MCU executes the write processing. Signing verification will be executed at the end of the last block. The secondary MCU sets the result in the command argument/result field and returns the response.

**Table 4-6 Data Format of the FWUP/WRITE Command**

Command	Packet	Device Address	Packet Type	Data Length		Command	Command Argument/Result	Command Data Length		Command Data			
				LSB	MSB			LSB	MSB	0	1	2	3
FWUP/ WRITE	Request	0xXX	0x02	8 + (length of write data)		0x04	0x00	4 + (length of write data)		Offset address [little endian]: 4 bytes Write data [big endian]: N bytes*2			
	ACK response		0x22	0x04	0x00		*	0x00	0x00				

Notes 1. The possible result values in the case of a response are listed below.

- 0x00: Successful operation
- 0xFF: Failed operation

2. Data are written in the same order as the transmitted binary data.

(3) **INSTALL**: Firmware install command

This command requests the installation and execution of the written update firmware.

The secondary MCU sets the result in the command argument/result field and returns the response, then executes the update firmware.

**Table 4-7 Data Format of the FWUP/INSTALL Command**

Command	Packet	Device Address	Packet Type	Data Length		Command	Command Argument/Result	Command Data Length	
				LSB	MSB			LSB	MSB
FWUP/ INSTALL	Request	0xXX	0x02	0x04	0x00	0x06	0x00	0x00	0x00
	ACK response		0x22				*		

Note: The possible result values in the case of a response are listed below.

- 0x00: Successful operation
- 0xFF: Failed operation

(4) **CANCEL**: Firmware update cancel command

This command requests that updating of the firmware be aborted.

The secondary MCU aborts updating and erases the written update firmware. The secondary MCU sets the result in the command argument/result field and returns the response.

**Table 4-8 Data Format of the FWUP/CANCEL Command**

Command	Packet	Device Address	Packet Type	Data Length		Command	Command Argument/Result	Command Data Length	
				LSB	MSB			LSB	MSB
FWUP/ CANCEL	Request	0xXX	0x02	0x04	0x00	0xF0	0x00	0x00	0x00
	ACK response		0x22				*		

Note: The possible result values in the case of a response are listed below.

- 0x00: Successful operation
- 0xFF: Failed operation

### 4.2.3.2 SENSOR Command

This command is used for controlling a sensor. Table 4-9 shows a list of the SENSOR commands.

**Table 4-9 List of SENSOR Commands**

Command Type	Command	Description
SENSOR	GET_HS300X: HS300x measured data acquisition command	Acquires the data measured by the HS300x sensor.

(1) GET\_HS300X: HS300x measured data acquisition command

This command requests transmission of the data measured by the HS300x sensor, which is connected to the secondary MCU.

The secondary MCU sets the result in the command argument/result field and returns the response.

The primary MCU refers to the command argument/result field and confirms the validity of the data. If the data are stale, the former state of the data is indicated.

**Table 4-10 Data Format of the SENSOR/GET\_HS300X Command**

Command	Packet	Device Address	Packet Type	Data Length		Command	Command Argument/Result	Command Data Length		Command Data			
				LSB	MSB			LSB	MSB	0	1	2	3
SENSOR/ GET_HS300X	Request	0xXX	0x03	0x04	0x00	0x01	0x00	0x00	0x00	Humidity [little endian]: 4 bytes [float type] Temperature [little endian]: 4 bytes [float type]			
	ACK response		0x23	0x0C			*						

Note: The possible result values in the case of a response are listed below.

- 0x00: Valid data
- 0x01: Stale data
- 0xFF: Failed operation

### 4.3 Folder/File Structure

Figure 4-6 shows the folder/file structure.

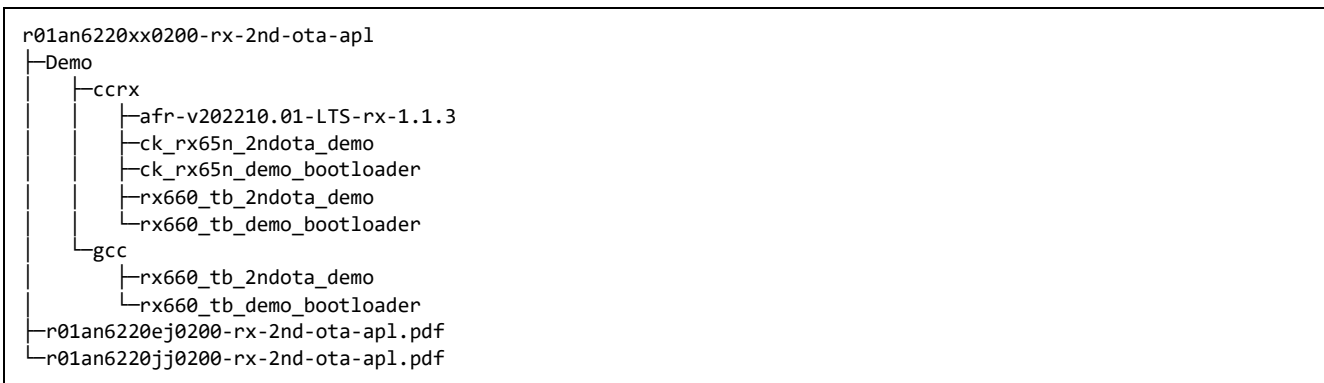

**Figure 4-6 Folder/File Structure**

The ck\_rx65n\_2ndota\_demo folder and ck\_rx65n\_demo\_bootloader folder contain project files for the CK-RX65N.

The rx660\_tb\_2ndota\_demo folder and rx660\_tb\_demo\_bootloader folder contain project files for the TB-RX660.

The projects for the CK-RX65N only support the CC-RX compiler and the projects for the TB-RX660 support the CC-RX and GCC compilers.

## 4.4 Code Size

The ROM and RAM sizes for projects included in the sample code of this application note are listed in the tables below. The values in the tables were confirmed under the following conditions.

- CC-RX
  - Compiler
    - Optimization level (-optimize): Level 2: Performs whole module optimization
    - Optimization type (-speed/-size): Optimizes with emphasis on code size
  - Linker
    - Optimization type (-nooptimize/-optimize): All
  - Library Generator
    - Optimization level (-optimize): Level 2: Performs whole module optimization
    - Optimization type (-speed/-size): Optimizes with emphasis on code size

**Table 4-11 Code Size (CC-RX)**

Project	ROM	RAM
ck_rx65n_demo_bootloader	33 Kbytes	9 Kbytes
ck_rx65n_2ndota_demo	368 Kbytes	345 Kbytes
rx660_tb_demo_bootloader	27 Kbytes	13 Kbytes
rx660_tb_2ndota_demo	49 Kbytes	22 Kbytes

- GCC
  - Optimization level: Optimize for debug (-Og)

**Table 4-12 Code Size (GCC)**

Project	ROM	RAM
rx660_tb_demo_bootloader	60 Kbytes	17 Kbytes
rx660_tb_2ndota_demo	90 Kbytes	41 Kbytes



## 5. Operations of the Demonstration

- (1) In the initial state of the demonstration, the TB-RX660 only acquires humidity data by using the HS3001 sensor.
- (2) The secondary OTA update mechanism is used to download the update firmware for the TB-RX660 from AWS via the CK-RX65N and then update the firmware.
- (3) After the firmware updating is complete, the TB-RX660 acquires temperature data in addition to humidity data from the HS3001 sensor.

In this sequence, the type of sensor data from which data are being acquired and the values can be checked from the log output from both microcontrollers to your PC and from the dashboard on AWS.

## 6. Setting up the Demonstration

This section describes the setting up required to run the demonstration covered by this application note.

The necessary steps are setting up the hardware, such as the wiring of the CK-RX65N and TB-RX660 and connection of the HS3001 sensor, setting up the software, such as creating and writing the initial firmware for each microcontroller board, and the preparation on the AWS cloud side for execution of the OTA update and display of the sensor data from AWS.

### 6.1 Setting up the Hardware

Firstly, the overall hardware structure for this demonstration is shown below. For an actual image after setup is complete, see Figure 6-12. The methods for setting up each of the boards are described in detail in the subsequent subsections.

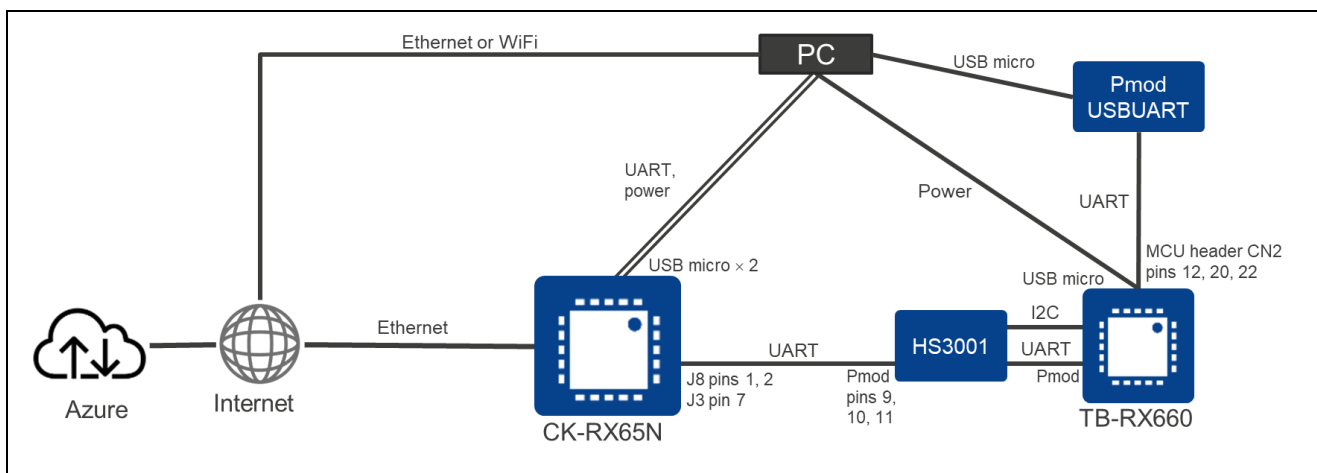

Figure 6-1 Overall Hardware Structure for This Demo

### 6.1.1 Setting up the CK-RX65N

The procedure for setting up the CK-RX65N is described in the following passages.

- (1) Connecting the cable for UART communications with the TB-RX660

TXD, RXD, and GND for UART communications with the TB-RX660 are allocated to the following pins on the J8 and J3 connectors of the CK-RX65N. Connect the pins on the TB-RX660 side as described in 6.1.2(3), with the corresponding UART signals listed in the table below.

**Table 6-1 UART Connection Method between the Microcontrollers (CK-RX65N ↔ HS3001 Sensor Board ↔ TB-RX660)**

CK-RX65N	*1	HS3001 Sensor Board Pmod I/F		TB-RX660 Pmod I/F
J8 Pin 1: D0/RX (RXD7)	↔	Pin 9: TXD*	↔	Pin 9: TXD9
J8 Pin 2: D1/TX (TXD7)	↔	Pin 10: RXD*	↔	Pin 10: RXD9
J3 Pin 7: GND	↔	Pin 11: GND	↔	Pin 11: GND

Note: Since the two Pmod pins on both sides of the HS3001 sensor board are directly connected to the corresponding pins on the other boards, the I/O signals of the TB-RX660 Pmod interface can be sent to the CK-RX65N via the HS3001 sensor board.

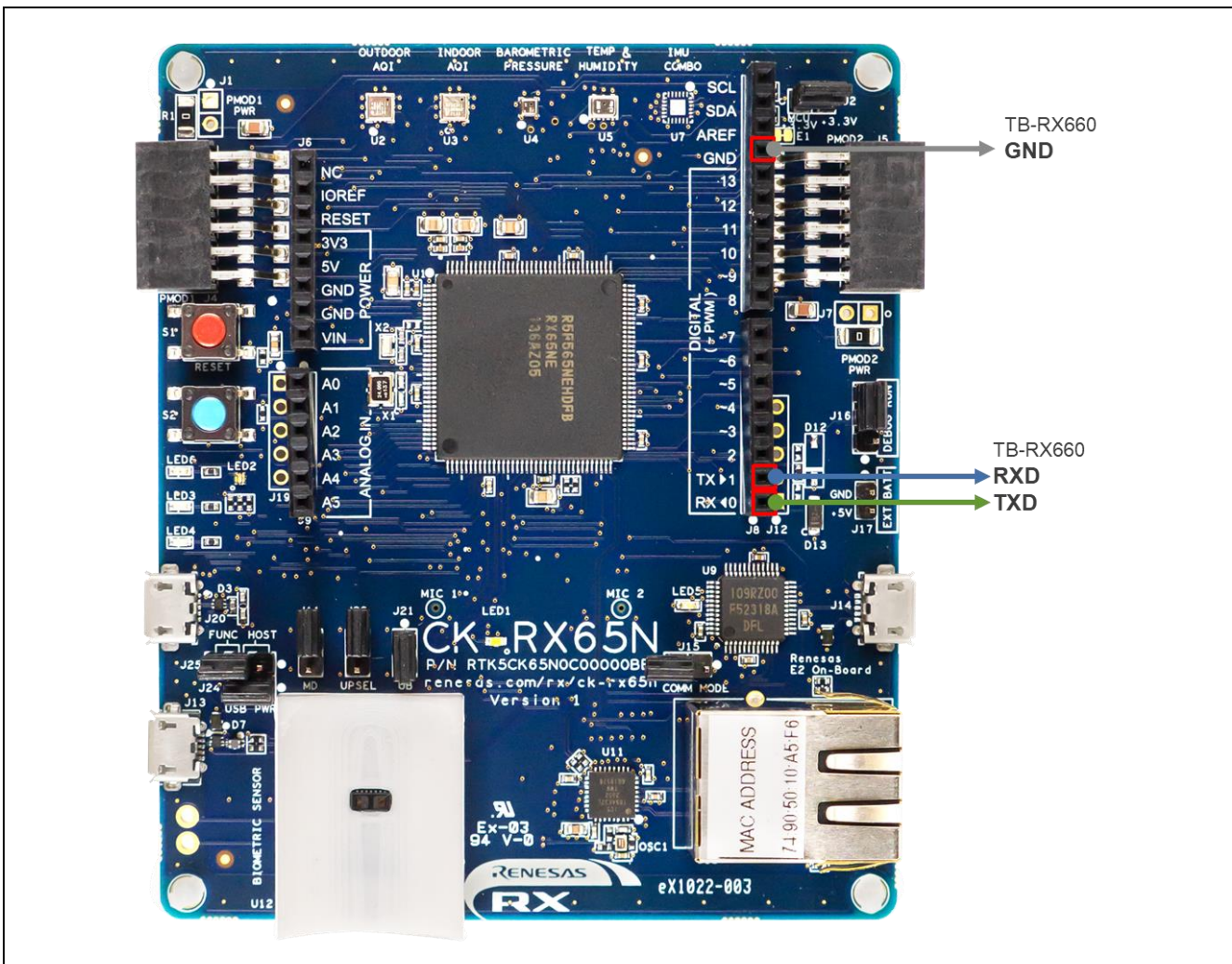

**Figure 6-2 Locations of Pins on the CK-RX65N Used for UART Communications between the Microcontrollers**

(2) Connecting the cable for log output to the PC

Connect the PC to the USB serial connector (micro USB Type-B) on the CK-RX65N with a USB cable.

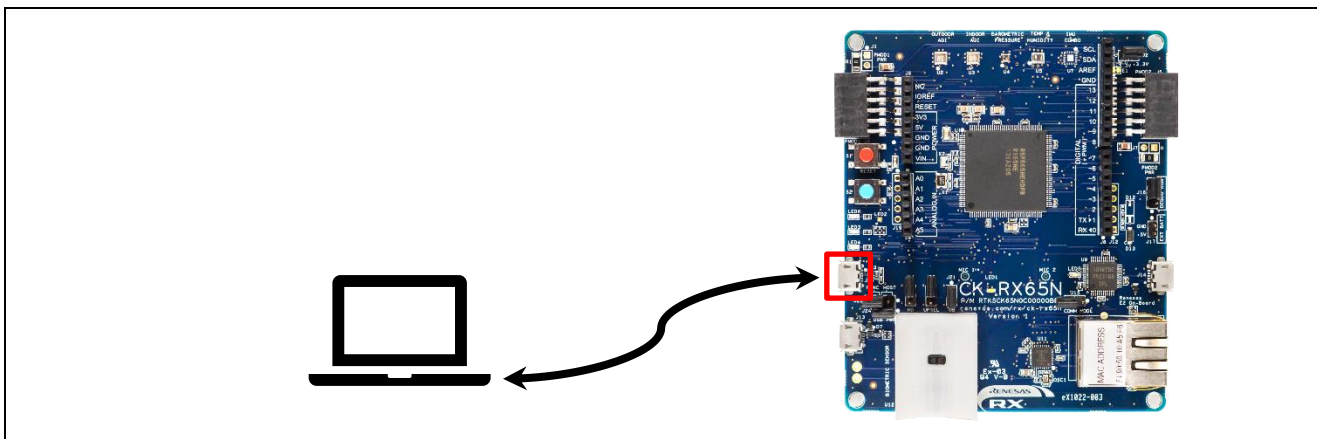

Figure 6-3 USB Connection for Log Output to the PC

(3) Connecting the power supply and debugger

Connect the PC to the E2OB Debugger connector (micro USB Type-B) on the CK-RX65N with a USB cable.

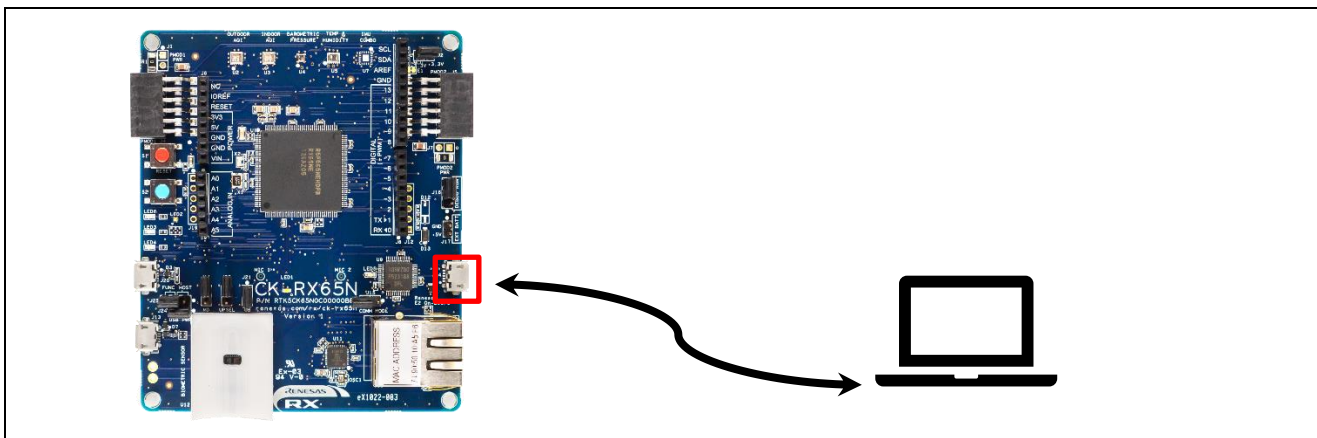

Figure 6-4 USB Connection of the Power Supply and Emulator

(4) Connecting the LAN cable for Internet connection

Connect the LAN cable connected with the Internet to the Ethernet connector on the CK-RX65N.

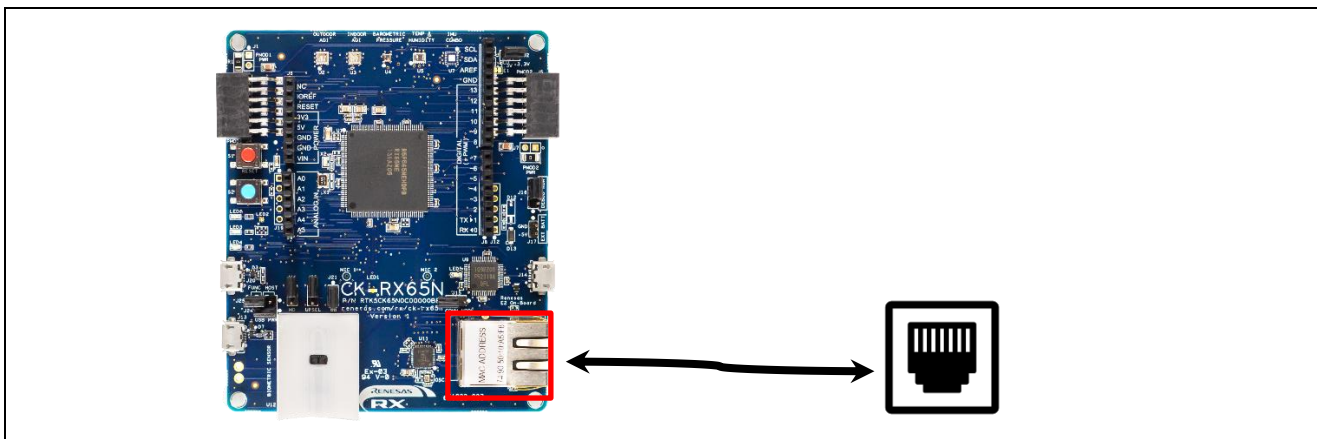

Figure 6-5 Wired Internet Connection with the Ethernet



(5) Closing jumper block J16 on the DEBUG side

To set the CK-RX65N to debug mode, close jumper block J16 on the DEBUG side (pins 1-2).

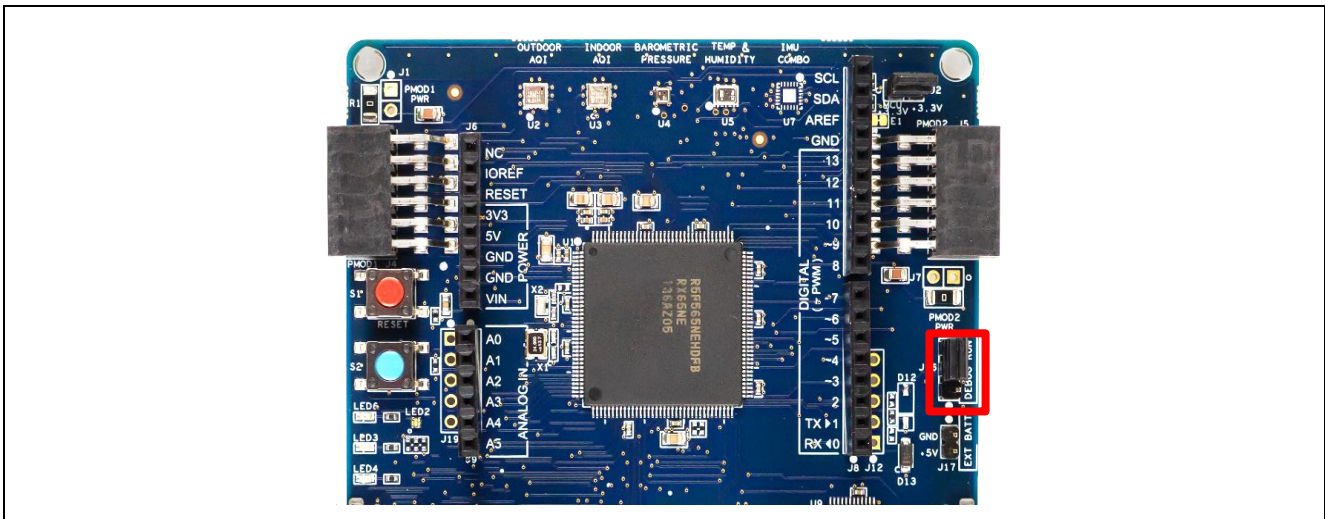

Figure 6-6 Location of Jumper Block J16

### 6.1.2 Setting up the TB-RX660

The procedure for setting up the TB-RX660 is described in the following passages.

(1) Advance preparation

Since headers are not inserted in the through holes on the board as shipped, make the following preparations in advance.

- Refer to “5.13 Emulator Reset Header” in the [TB-RX660 User's Manual](#) and mount the pin header.
- Refer to “5.14 Power-Supply Selection Header” in the [TB-RX660 User's Manual](#) and take the necessary steps to supply a voltage of 3.3 V. In this demonstration, the operating voltage for the RX660 is 3.3 V.
- Mount a CN2 connector on the TB-RX660.

(2) Connecting the HS3001 board

Connect the HS3001 board to the Pmod connector on the TB-RX660.

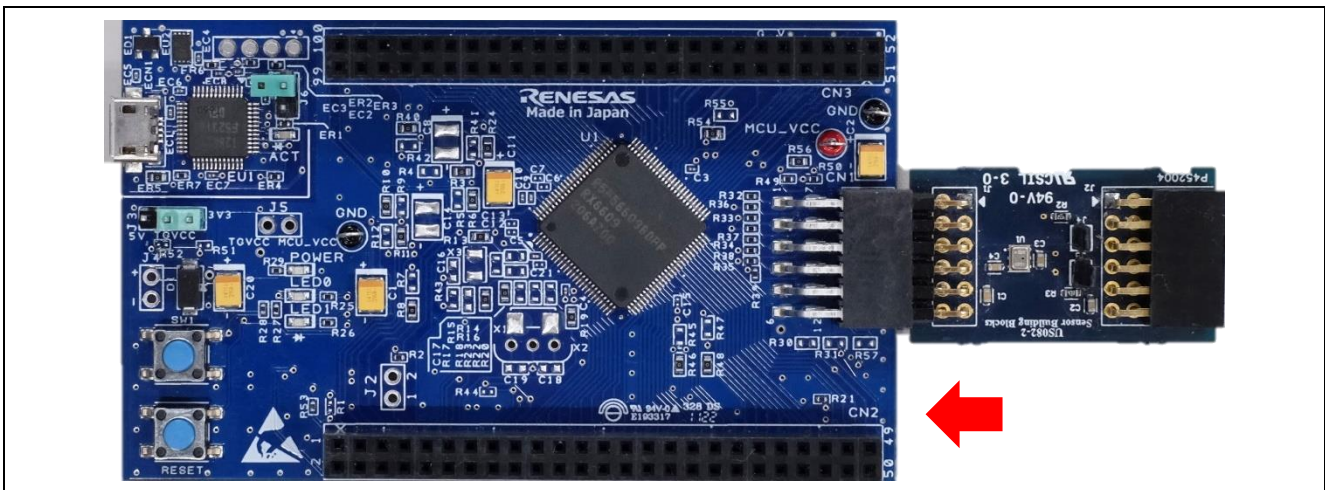

Figure 6-7 Connecting the Sensor Board to the Pmod Connector on the TB-RX660

(3) Connecting the cable for UART communications with the CK-RX65N

TXD, RXD, and GND for UART communications with the CK-RX65N are allocated to the following pins on the Pmod connector of the TB-RX660. Connect the pins on the CK-RX65N as described in 6.1.1(1), with the corresponding UART signals listed in Table 6-1.

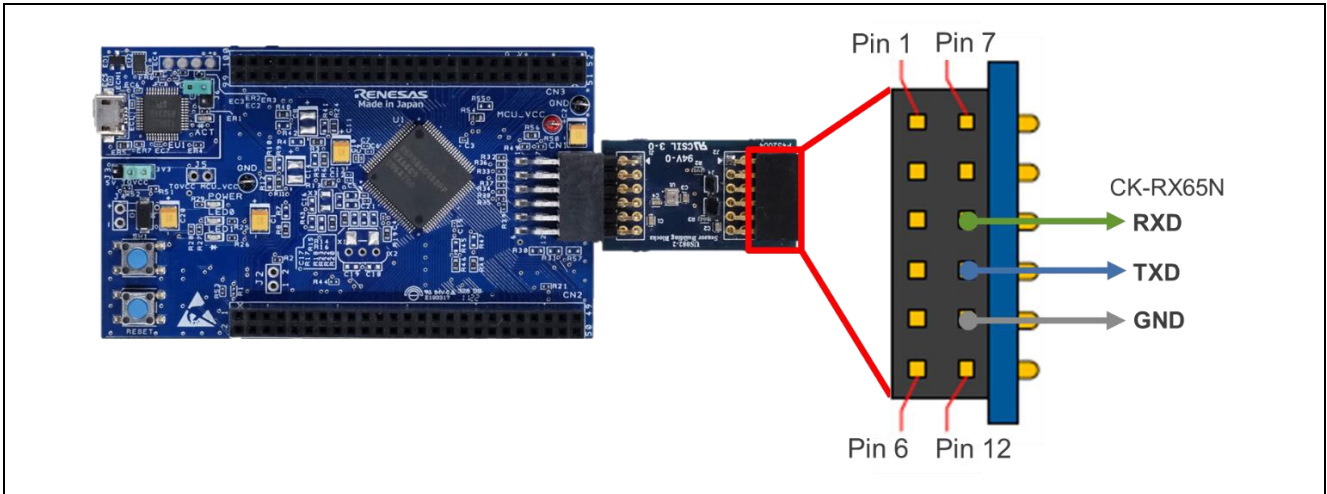

Figure 6-8 Locations of Pins on the TB-RX660 Used for UART Communications between the Microcontrollers

(4) Connecting the cable for serial communications to be used in log output to the PC

TXD, RXD, and GND for log output to the PC through a serial connection are allocated to the following pins on the MCU header CN2 of the TB-RX660. Connect the pins on the Pmod USB-to-UART converter as shown in the following table and figure, with the corresponding UART signals listed in the table below.

Close jumper block JP1 of the Pmod USB-to-UART converter on the VCC-LCL side. This makes the UART interface voltage become 3.3 V due to the power supply being from the micro-USB side.

Also, connect the PC and the micro USB Type-B connector on the Pmod USB-to-UART converter with a USB cable.

Table 6-2 Connection Method between the TB-RX660 and Pmod USB-to-UART Converter

TB-RX660 MCU Header CN2		Pmod USB-to-UART Converter Pmod I/F
Pin 12: GND	↔	Pin 5: GND
Pin 20: RXD1 (MCU P30)	↔	Pin 3: TXD
Pin 22: TXD2 (MCU P26)	↔	Pin 2: RXD

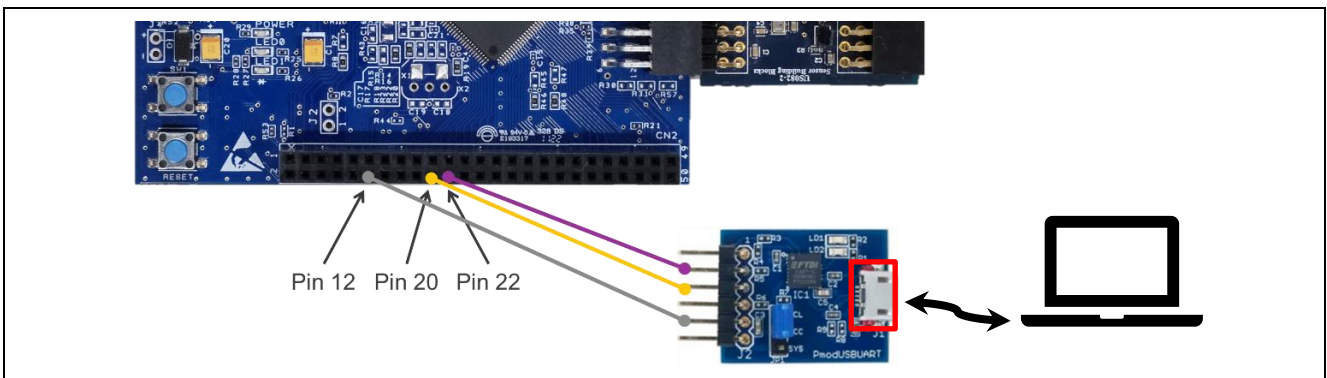

Figure 6-9 Connecting TB-RX660 with the Serial Communications Cable for Log Output to the PC



(5) Connecting the cable for power supply

Connect the PC and the micro USB Type-B connector on the TB-RX660 with a USB cable.

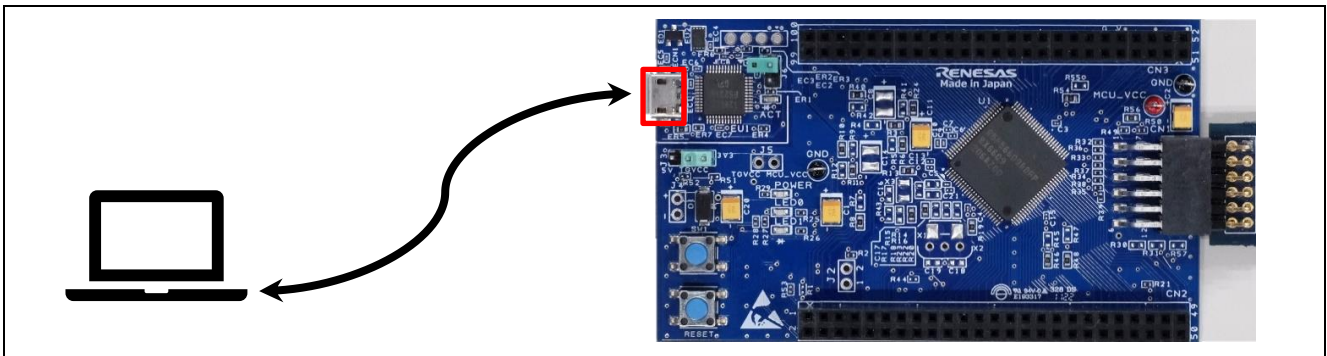

Figure 6-10 Connecting the USB Cable for the Power Supply and Emulator

(6) Opening the emulator reset header (J6)

Open the emulator reset header (J6) on the TB-RX660.

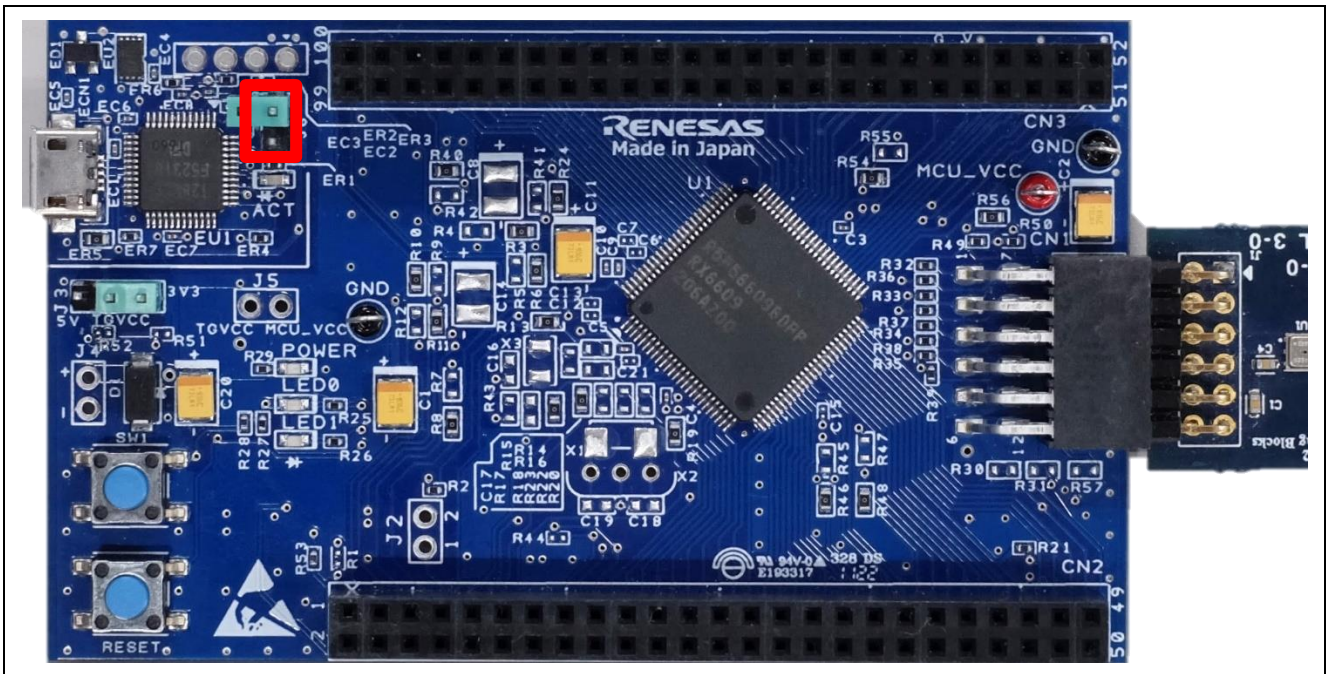

Figure 6-11 Location of the Emulator Reset Header (J6)

The hardware setup for the demonstration is now completed. Figure 6-12 is an image of the overall configuration for the demonstration.

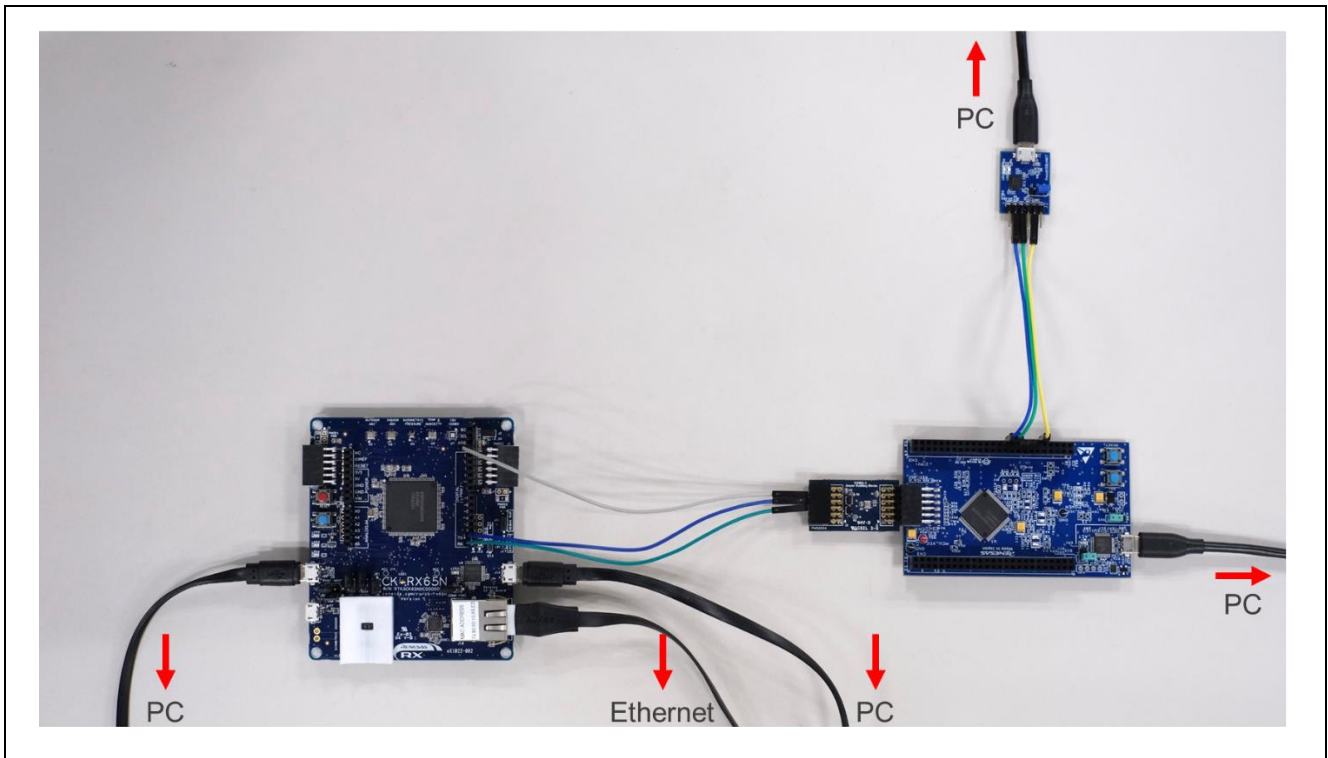

Figure 6-12 Image of the Overall Configuration for the Demo

## 6.2 Setting up the Software

### 6.2.1 Advance Preparation

For each of the software versions used in confirming operation, see Table 2-4.

#### (1) Installing QE for OTA

From the e<sup>2</sup> studio menu bar, select [Renesas Views] → [Renesas QE] to check whether QE for OTA is installed. If [OTA Main (QE)] and [OTA Manage IoT Device (QE)] are displayed, installation is completed.

If they are not displayed, refer to “2.1 Install QE for OTA” in “[RX Family Firmware Update Software Development Guide using AWS/Azure QE for OTA \(R20AN0712\)](#)” and install QE for OTA.

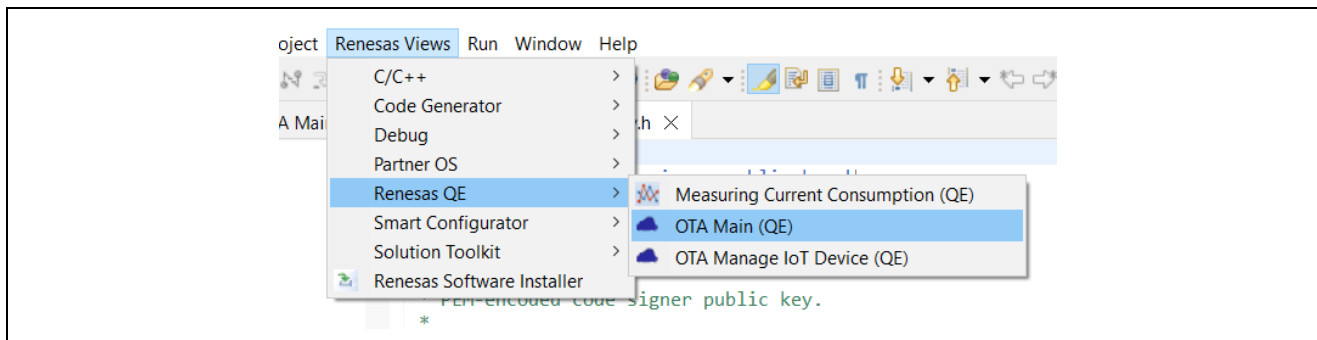

Figure 6-13 Confirming the Installation of QE for OTA

#### (2) Installing the Python execution environment

Python can be downloaded from <https://www.python.org/>.

The PyCryptodome library of Python is also to be used. After installing Python, execute the follow pip command to install it.

```
> pip install pycryptodome
```

#### (3) Installing the Renesas Flash Programmer

The Renesas Flash Programmer can be downloaded from [Renesas Flash Programmer \(Programming GUI\) | Renesas](#).

### 6.2.2 Setting the Terminal Software

The terminal software (e.g., [Tera Term](#)) is required to generate log output using serial communication. The serial port settings are shown in the following.

Table 6-3 Serial Port Settings

Item	Setting
Baud rate	115,200 bps
Data length	8 bits
Parity bit	None
Stop bit	1 bit
Flow control	None



### 6.2.3 Creating and Running the Initial Firmware for the CK-RX65N

Create initial firmware for the CK-RX65N by using QE for OTA and execute debugging in e<sup>2</sup> studio. The procedure is described below.

#### (1) Importing projects

Import the “ck\_rx65n\_demo\_bootloader” project, a bootloader for the CK-RX65N, and the “ck\_rx65n\_2ndota\_demo” project, a user program, into e<sup>2</sup> studio.

When importing projects, uncheck [Copy projects into workspace] in the [Options] field.

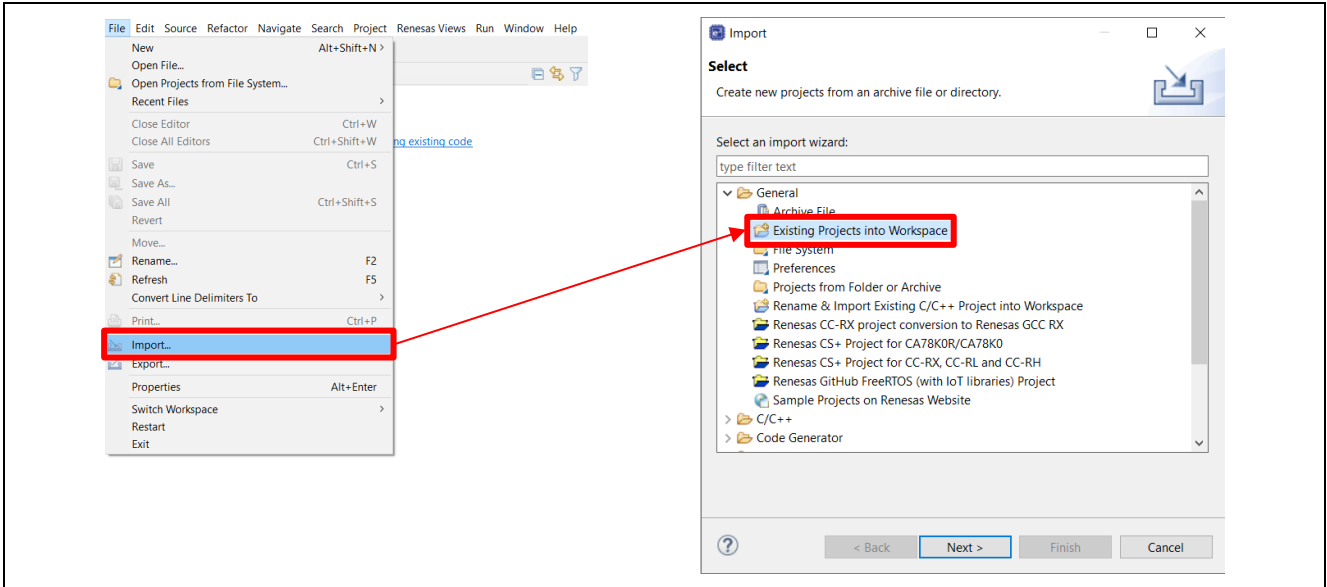

Figure 6-14 Importing Projects (1)

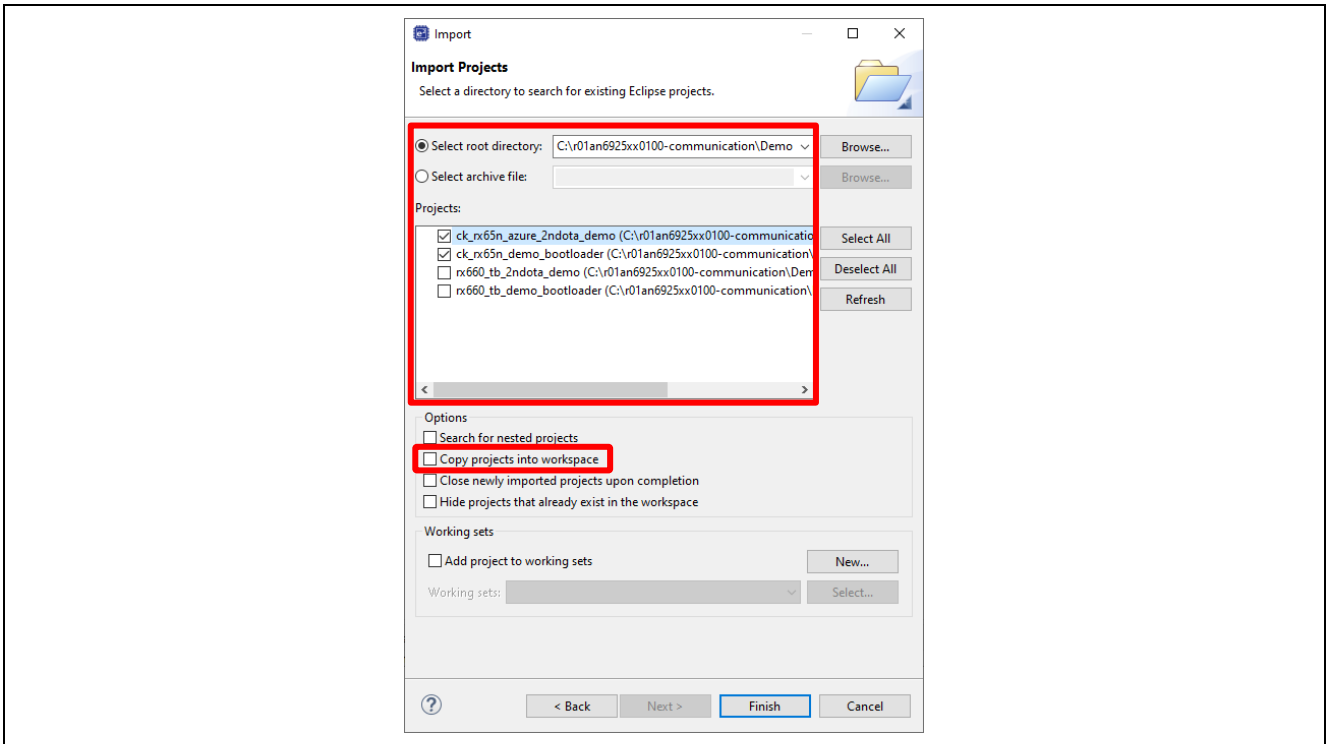

Figure 6-15 Importing Projects (2)

(2) Opening the QE for OTA window

From the e<sup>2</sup> studio menu bar, select [Renesas Views] → [Renesas QE] → [OTA Main (QE)].

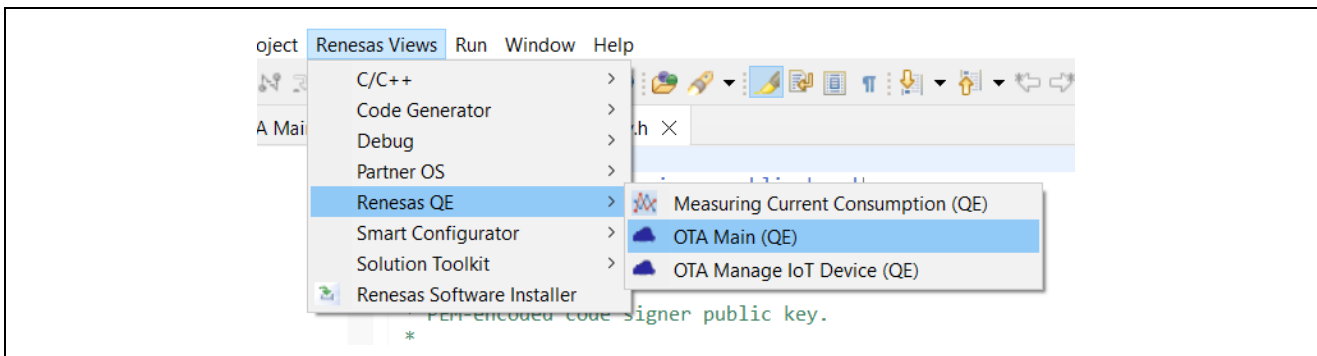

Figure 6-16 Opening the QE for OTA Window

(3) <QE for OTA> [1. Cloud Settings] → [Sign-in to Cloud]

From here, follow the steps displayed in the GUI window of QE for OTA.

Start by selecting “AWS” for [Cloud] and sign in. An AWS resource is generated in the region selected at the time of login.

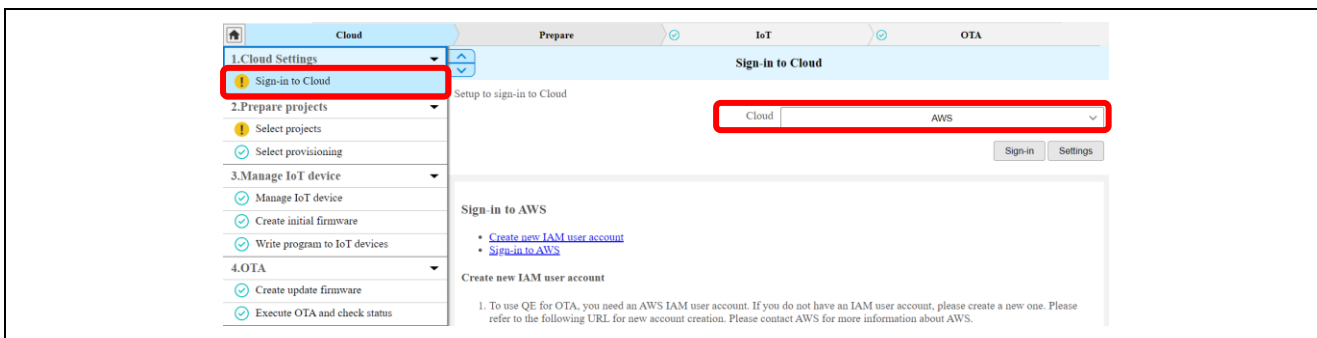

Figure 6-17 Signing in to AWS with QE for OTA

(4) <QE for OTA> [2. Prepare projects] → [Select projects]

Select the ck\_rx65n\_demo\_bootloader project and the ck\_rx65n\_2ndota\_demo project that were imported into e<sup>2</sup> studio earlier.

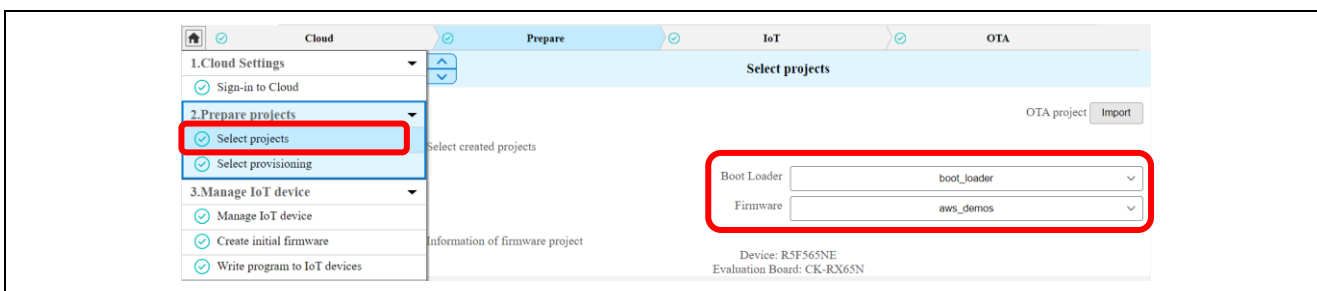

Figure 6-18 Selecting Projects

(5) <QE for OTA> [2. Prepare projects] → [Select provisioning]

Select “Source code includes credentials (asymmetric keys)” as the provisioning method.

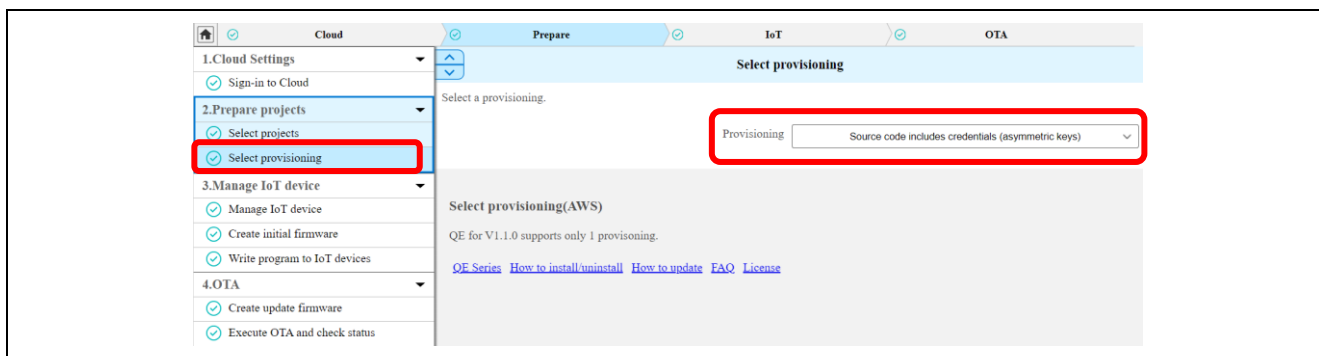

Figure 6-19 Selecting the Provisioning Method

(6) <QE for OTA> [3. Manage IoT device] → [Manage IoT device]

Create an IoT device following the procedure of QE for OTA.

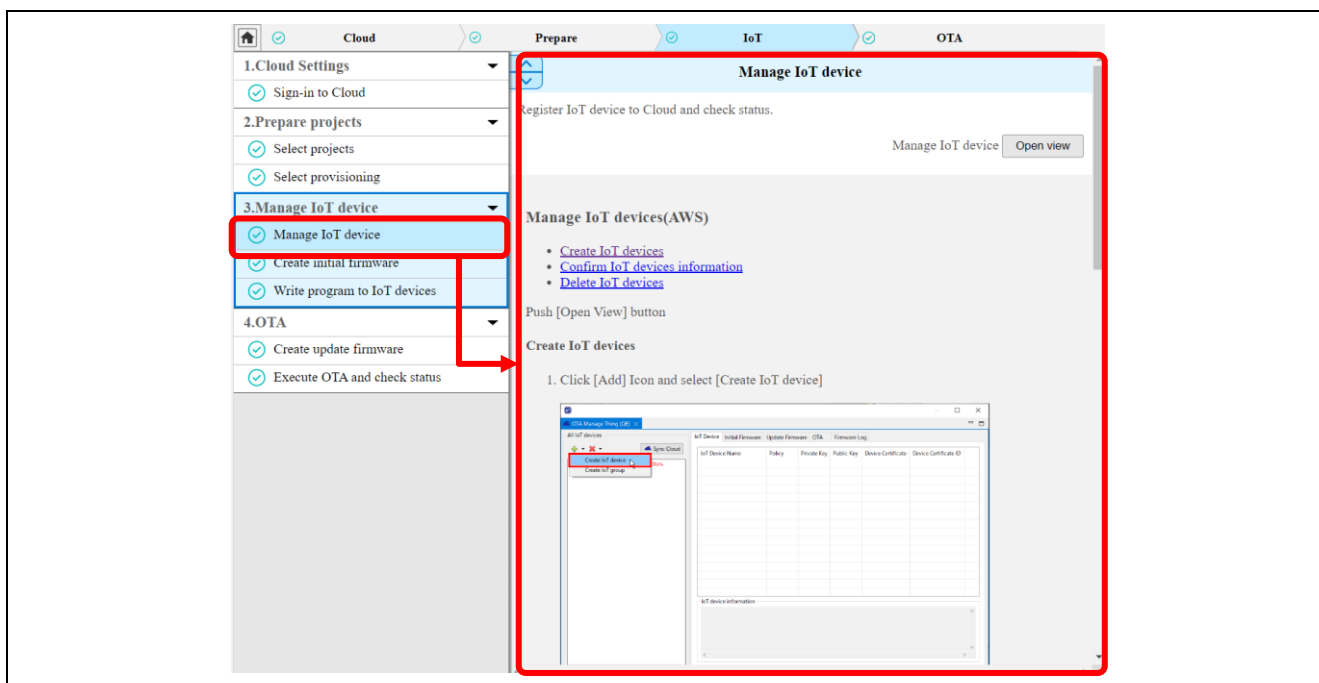

Figure 6-20 Creating an IoT Device

(7) <QE for OTA> [3. Manage IoT device] → [Create initial firmware]

Create initial firmware following the procedure of QE for OTA.

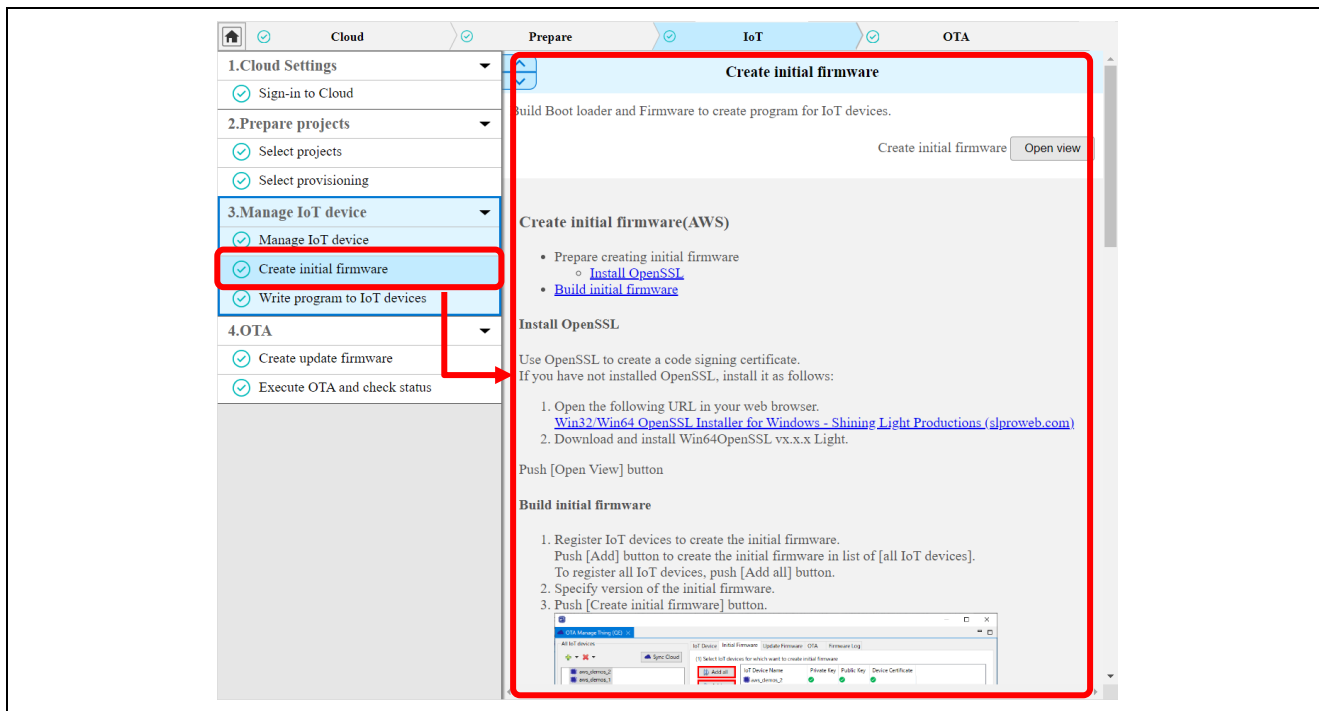

Figure 6-21 Creating the Initial Firmware

(8) <QE for OTA> [3. Manage IoT device] → [Write program to IoT devices]

Write the initial firmware to the CK-RX65N following the procedure of QE for OTA.

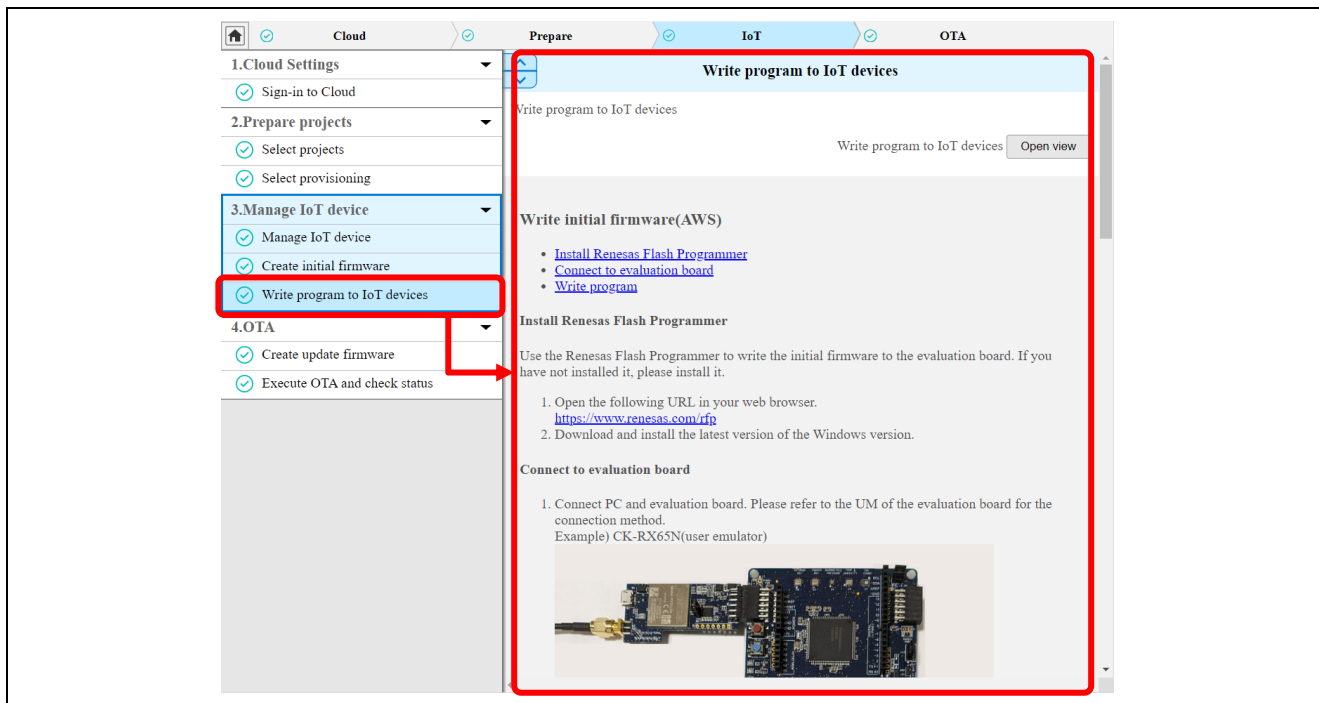
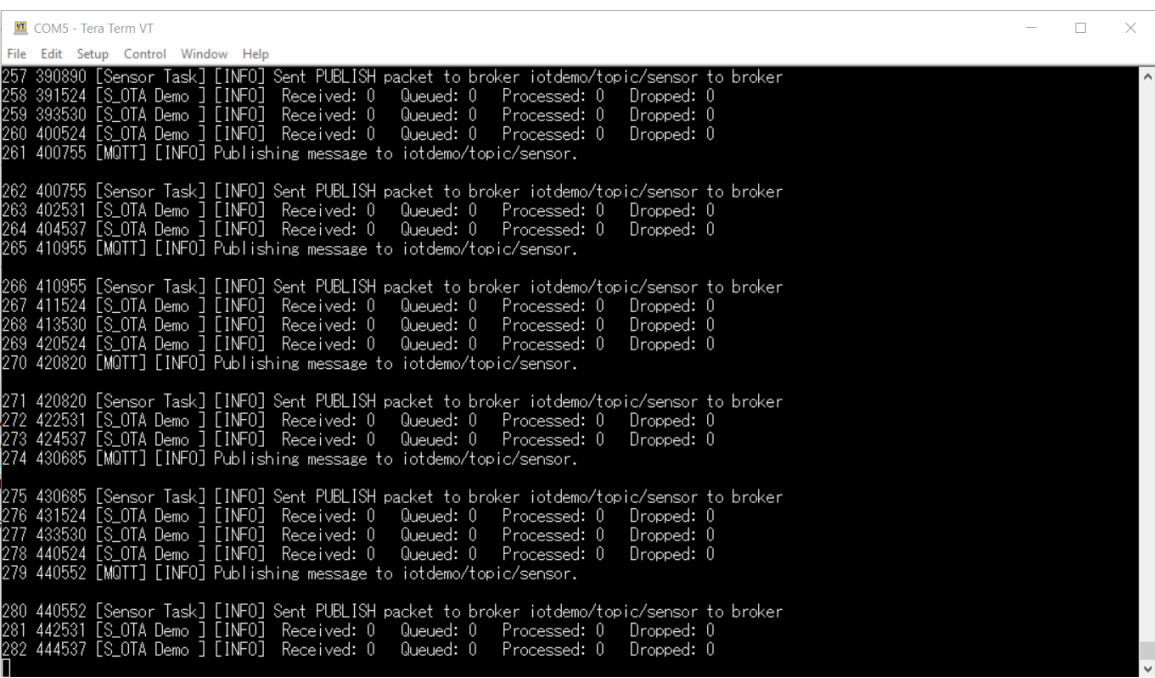

Figure 6-22 Writing the Initial Firmware

## (9) Checking operation

Close jumper block J16 in Figure 6-6 on the RUN side (pins 2-3).

Launch the terminal software, and if the log is output as shown in Figure 6-23, the CK-RX65N is ready to run.



```

COM5 - Tera Term VT
File Edit Setup Control Window Help
257 390890 [Sensor Task] [INFO] Sent PUBLISH packet to broker iotdemo/topic/sensor to broker
258 391524 [S_OTA Demo] [INFO] Received: 0 Queued: 0 Processed: 0 Dropped: 0
259 393530 [S_OTA Demo] [INFO] Received: 0 Queued: 0 Processed: 0 Dropped: 0
260 400524 [S_OTA Demo] [INFO] Received: 0 Queued: 0 Processed: 0 Dropped: 0
261 400755 [MQTT] [INFO] Publishing message to iotdemo/topic/sensor.
262 400755 [Sensor Task] [INFO] Sent PUBLISH packet to broker iotdemo/topic/sensor to broker
263 402531 [S_OTA Demo] [INFO] Received: 0 Queued: 0 Processed: 0 Dropped: 0
264 404537 [S_OTA Demo] [INFO] Received: 0 Queued: 0 Processed: 0 Dropped: 0
265 410955 [MQTT] [INFO] Publishing message to iotdemo/topic/sensor.
266 410955 [Sensor Task] [INFO] Sent PUBLISH packet to broker iotdemo/topic/sensor to broker
267 411524 [S_OTA Demo] [INFO] Received: 0 Queued: 0 Processed: 0 Dropped: 0
268 413530 [S_OTA Demo] [INFO] Received: 0 Queued: 0 Processed: 0 Dropped: 0
269 420524 [S_OTA Demo] [INFO] Received: 0 Queued: 0 Processed: 0 Dropped: 0
270 420820 [MQTT] [INFO] Publishing message to iotdemo/topic/sensor.
271 420820 [Sensor Task] [INFO] Sent PUBLISH packet to broker iotdemo/topic/sensor to broker
272 422531 [S_OTA Demo] [INFO] Received: 0 Queued: 0 Processed: 0 Dropped: 0
273 424537 [S_OTA Demo] [INFO] Received: 0 Queued: 0 Processed: 0 Dropped: 0
274 430685 [MQTT] [INFO] Publishing message to iotdemo/topic/sensor.
275 430685 [Sensor Task] [INFO] Sent PUBLISH packet to broker iotdemo/topic/sensor to broker
276 431524 [S_OTA Demo] [INFO] Received: 0 Queued: 0 Processed: 0 Dropped: 0
277 433530 [S_OTA Demo] [INFO] Received: 0 Queued: 0 Processed: 0 Dropped: 0
278 440524 [S_OTA Demo] [INFO] Received: 0 Queued: 0 Processed: 0 Dropped: 0
279 440552 [MQTT] [INFO] Publishing message to iotdemo/topic/sensor.
280 440552 [Sensor Task] [INFO] Sent PUBLISH packet to broker iotdemo/topic/sensor to broker
281 442531 [S_OTA Demo] [INFO] Received: 0 Queued: 0 Processed: 0 Dropped: 0
282 444537 [S_OTA Demo] [INFO] Received: 0 Queued: 0 Processed: 0 Dropped: 0

```

Figure 6-23 Log Screen of the CK-RX65N

### 6.2.4 Creating and Running the Initial Firmware for the TB-RX660

Create initial firmware for the TB-RX660 and write it to the microcontroller by using the Renesas Flash Programmer. The procedure is described below.

#### (1) Importing projects

Similarly to the procedure for importing projects for the CK-RX65N described in the previous subsection, import the “rx660\_tb\_demo\_bootloader” project, a bootloader for the TB-RX660, and the “rx660\_tb\_2ndota\_demo” project, a user program, into e<sup>2</sup> studio. These projects are provided as sample code with this application note.

#### (2) Building projects

Build the rx660\_tb\_demo\_bootloader project and the rx660\_tb\_2ndota\_demo project and create a MOT file for each. The MOT files are created in the HardwareDebug folder directly under the project folder.

#### (3) Creating the initial firmware

The initial firmware for the TB-RX660 is created by combining the created MOT files of the rx660\_tb\_demo\_bootloader and rx660\_tb\_2ndota\_demo projects. The Renesas Image Generator is a tool for use in combining MOT files and is included with the [“RX Family Firmware Update Module Using Firmware Integration Technology Rev.2.01”](#) Application Note. For details, refer to the “Renesas Image Generator” section in the application note at the link above.

Execute the following command in the rx660\_tb\_2ndota\_demo\RenesasImageGenerator folder to create the initial firmware “initial\_firm.mot”.

```

> python .\image-gen.py -iup ..\HardwareDebug\rx660_tb_2ndota_demo.mot -
ibp ..\..\rx660_tb_demo_bootloader\HardwareDebug\rx660_tb_demo_bootloader.mot -
o .\initial_firm -key .\keys\secp256r1.privatekey -
ip .\RX660_Linear_Half_ImageGenerator_PRM.csv -vt ecdsa

```

(4) Writing the initial firmware

Using the Renesas Flash Programmer, write the initial firmware “initial\_firm.mot” that was created in the previous step to the TB-RX660.

Open the Renesas Flash Programmer project “rx660\_program.rpj” in the rx660\_tb\_2ndota\_demo\rfp folder, specify the initial firmware for the RX660 “initial\_firm.mot” that was just created in the [Program File] field, and click on [Start].

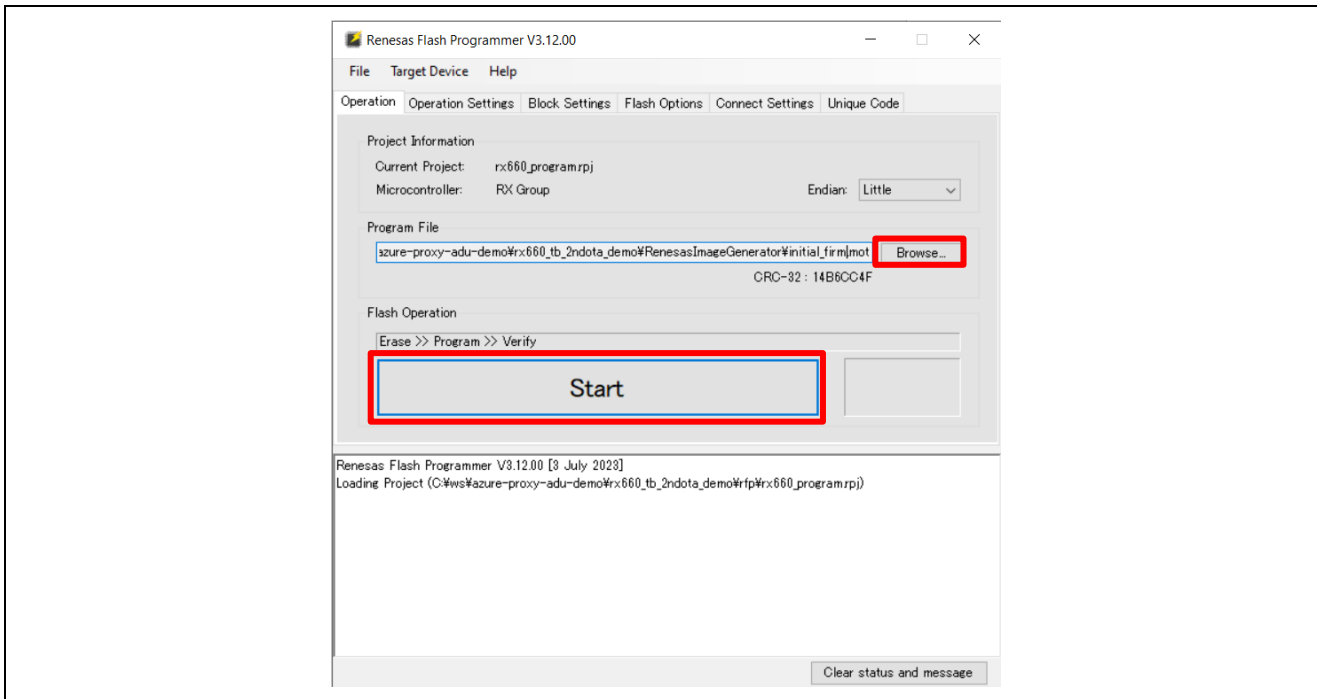

Figure 6-24 Writing the Initial Firmware with the Renesas Flash Programmer

(5) Checking operation

Close the emulator reset header (J6) on the TB-RX660.

Launch the terminal software, and if the values for humidity are output in the log as shown in Figure 6-25, the TB-RX660 is ready to run.

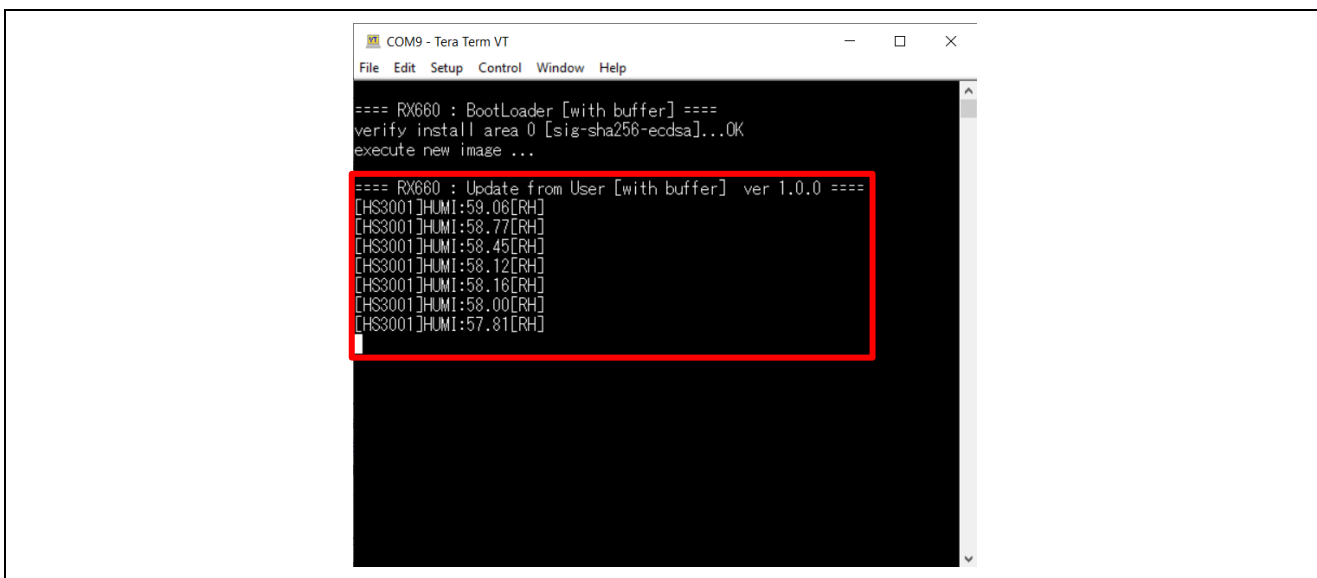

Figure 6-25 Log Screen of the TB-RX660

### 6.3 Preparations for Using the AWS Cloud

Start by logging in to the AWS Management Console.

[Manage AWS Resources - AWS Management Console - AWS \(amazon.com\)](#)

Confirm the region displayed in the upper-right corner of the management console screen and select the same region as that set at the time of logging in to QE for OTA.

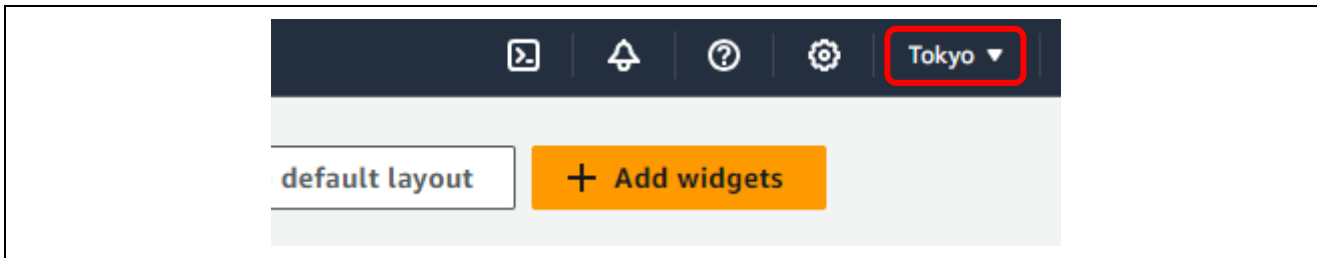

Figure 6-26 Confirming the Region

#### 6.3.1 Settings for the OTA Update

Refer to the “[RX Family How to implement FreeRTOS OTA using Amazon Web Services in RX65N \(for v202210.01-LTS-rx-1.1.0 or later\)](#)” Application Note and make the necessary settings.

- (1) Create an Amazon S3 bucket according to the procedure described in “3.4 Creating an Amazon S3 bucket” in the above application note. The bucket name set here will be used when running the demonstration.
- (2) Create a service role according to the procedure described in “3.5 Allocating OTA execution permission to IAM users” in the above application note. The service role name set here will be used when running the demonstration.
- (3) Register a code signing certificate according to the procedure described in (5) to (9) in “5.2 Updating the firmware” in the above application note. The code signing certificate to be registered here is the certificate created when the initial firmware for the CK-RX65N was created by using QE for OTA in 6.2.3(7).

The certificate is created in “ck\_rx65n\_demo\_bootloader/QE-OTA/codesigning”. Specify secp256r1.crt for the certificate, secp256r1.privateKey for the private key, and ca.crt for the certificate chain.

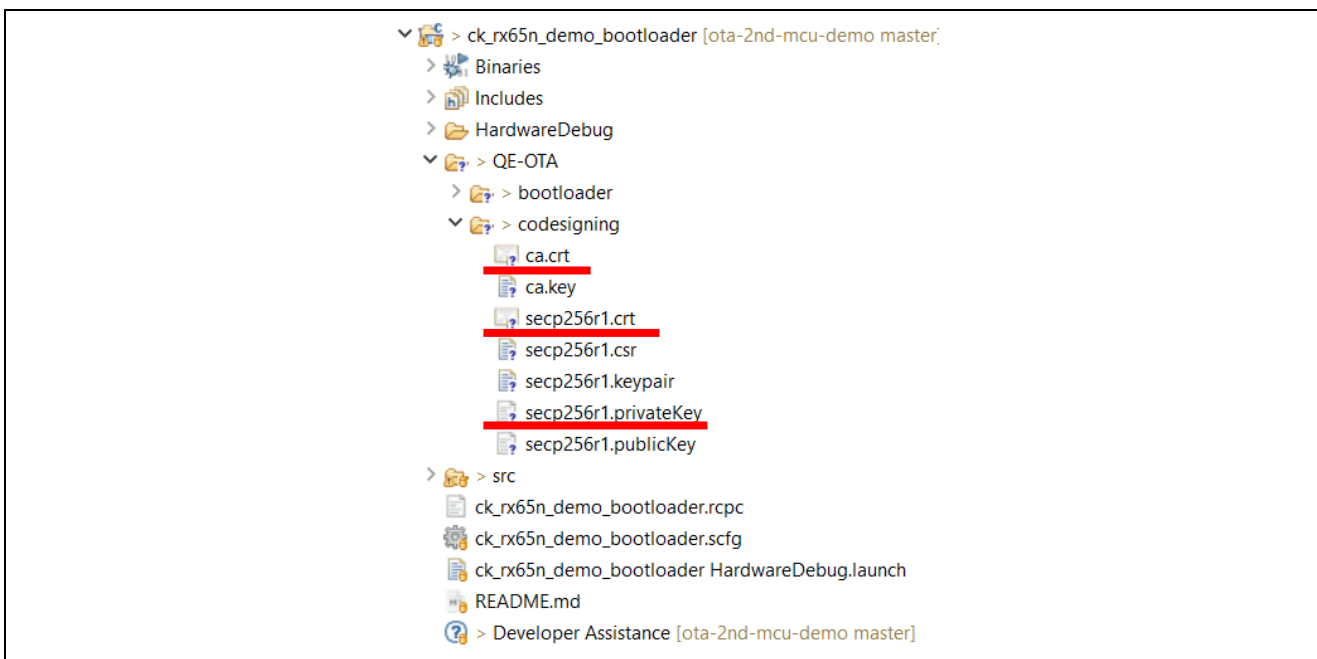

Figure 6-27 Location Where the Code Signing Certificate is Created

### 6.3.2 Settings for Displaying the Sensor Data

To display the received sensor data in a graphical format, set up Amazon CloudWatch and AWS IoT Core through the following steps.

**Note:** If you do not need to display the data in a graphical format, but only need to confirm in your browser that the data have been received by AWS, you can omit the entire procedure in 6.3.2.

In this case, as shown in Figure 6-28, you can subscribe to “iotdemo/topic/sensor” in [MQTT test client] of AWS IoT to confirm in a text format that the sensor data are being received as expected.

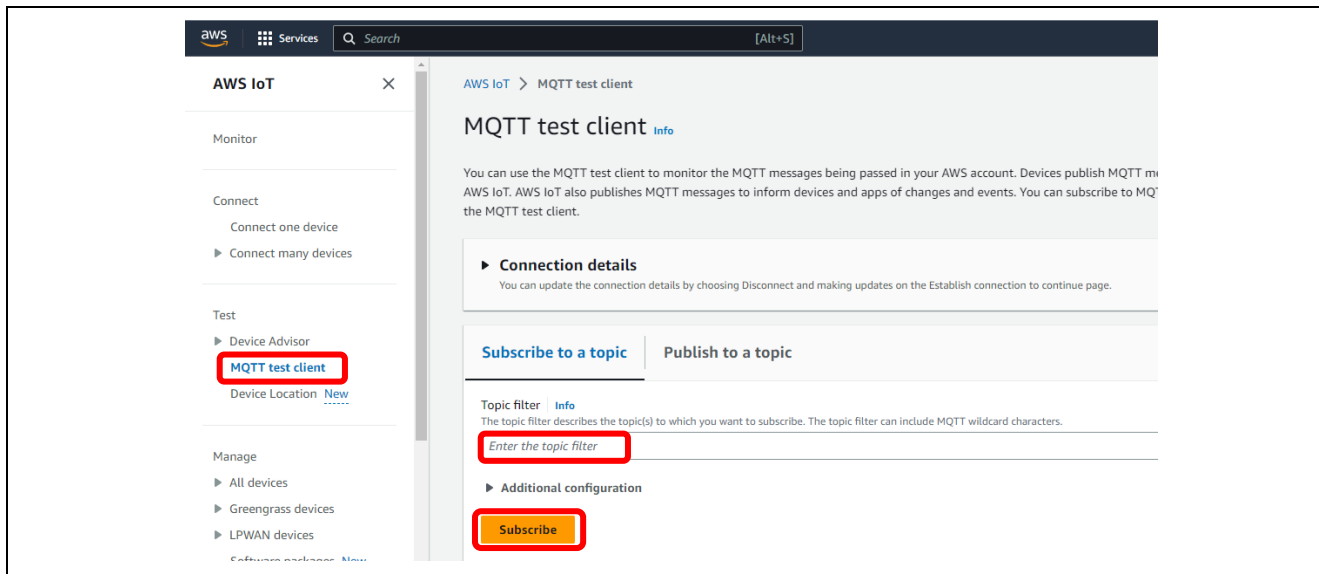

Figure 6-28 Confirming Data Reception by the MQTT Test Client



### 6.3.2.1 Setting up Amazon CloudWatch

#### (1) Creating rules in AWS IoT

Click on [AWS IoT] → [Rules] → [Create rule].

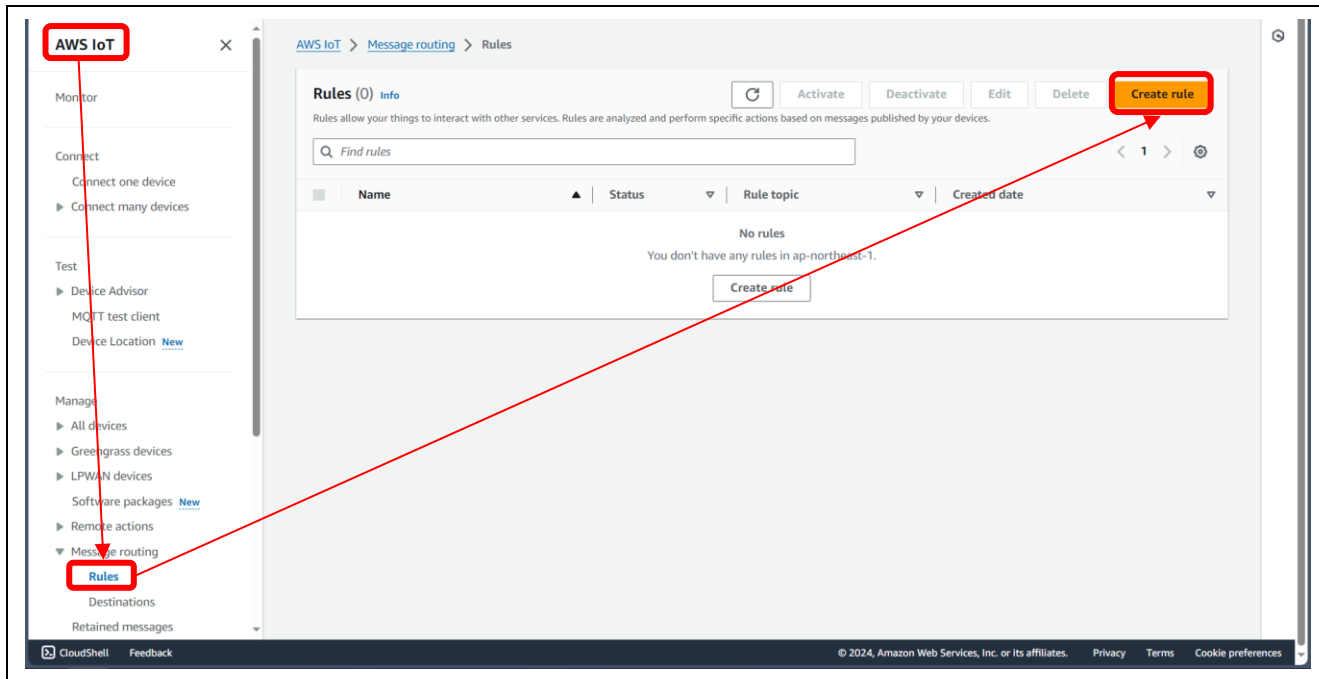

#### (2) Specifying the rule properties

Enter a rule name in [Rule name] and click on [Next].

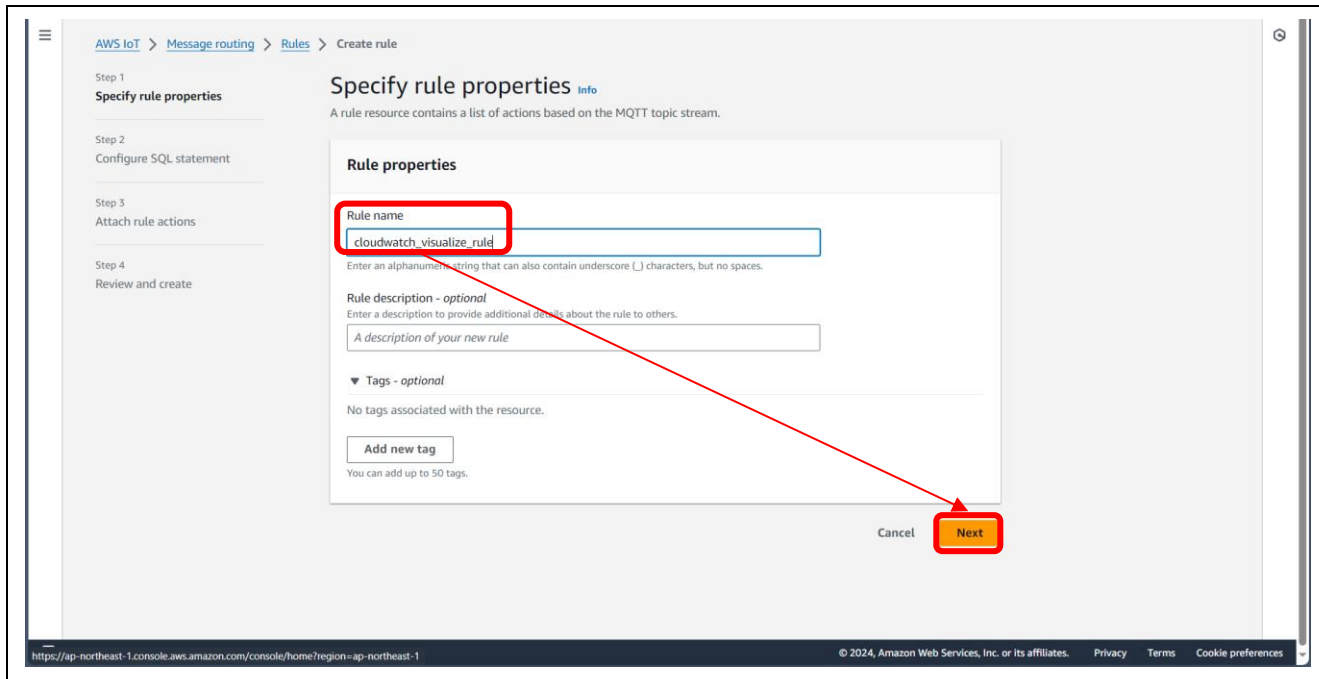

(3) Setting the SQL statement

Enter the SQL statement by entering code like the following in the text editor field for [SQL statement]. Be sure to add a new line character at the end.

```
SELECT *, timestamp() as timestamp FROM 'iotdemo/topic/sensor'
```

(A new line has to be entered at the end of the line above.)

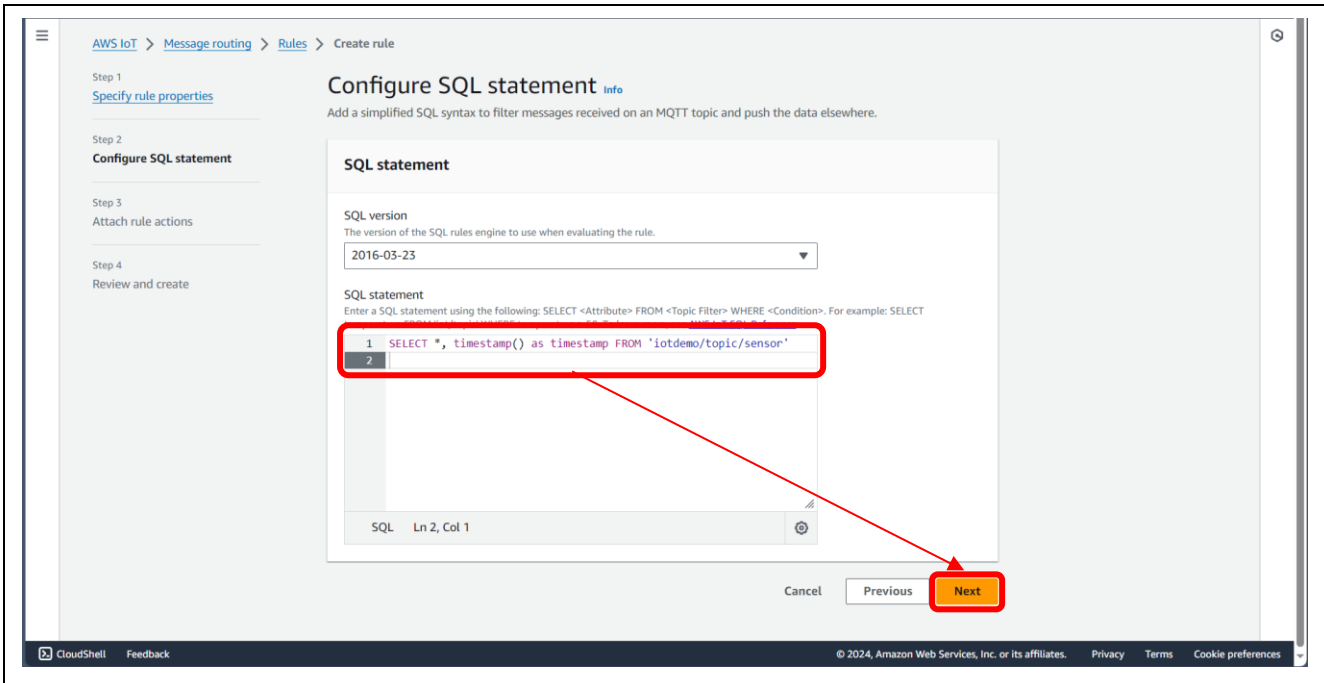

(4) Selecting rule actions in the [Attach rule actions] step

Select "CloudWatch logs" for [Action 1] and click on [Create CloudWatch Log group].

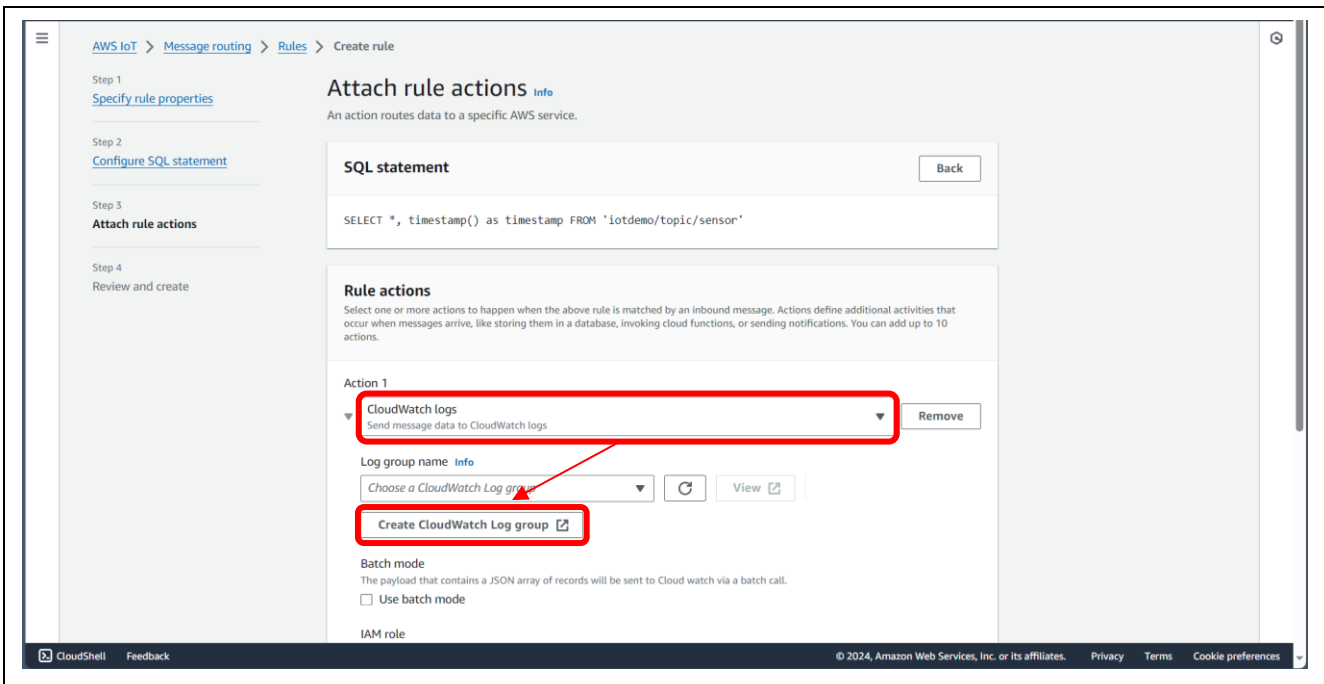

(5) Creating a log group

Enter a log group name and click on [Create].

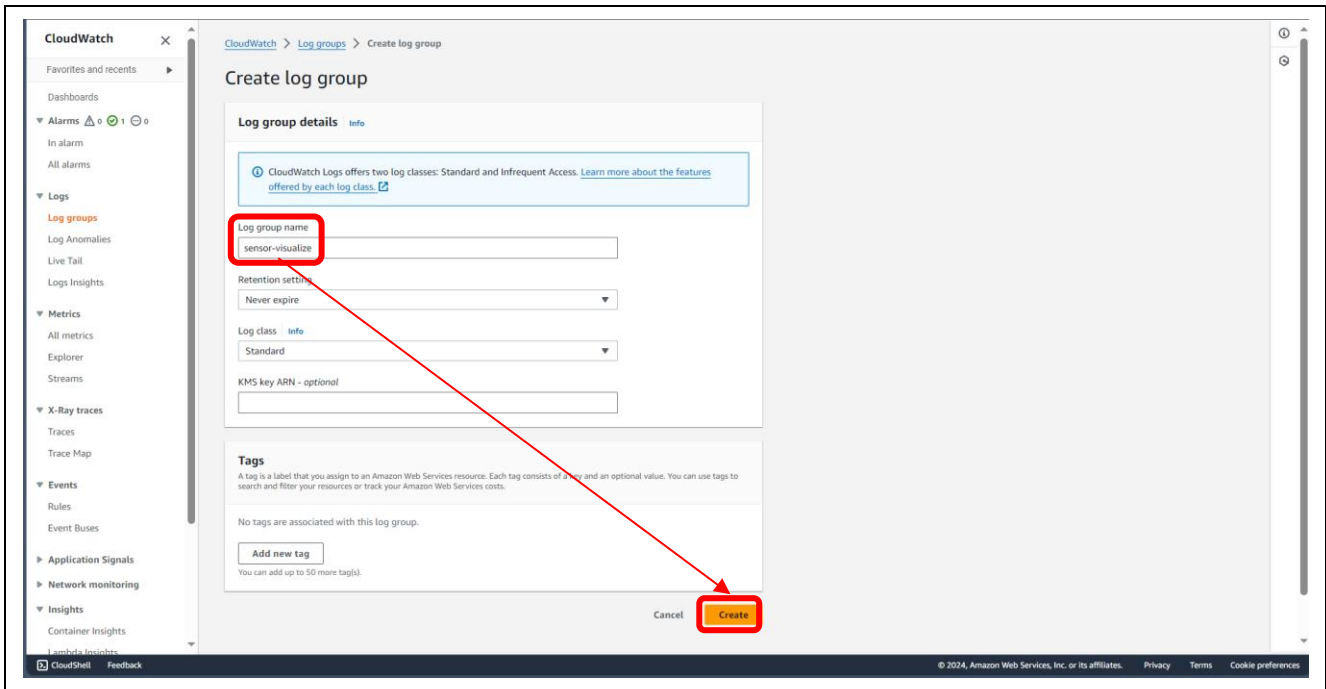

(6) Creating a new role

Select the created log group in [Log group name] and click on [Create new role].

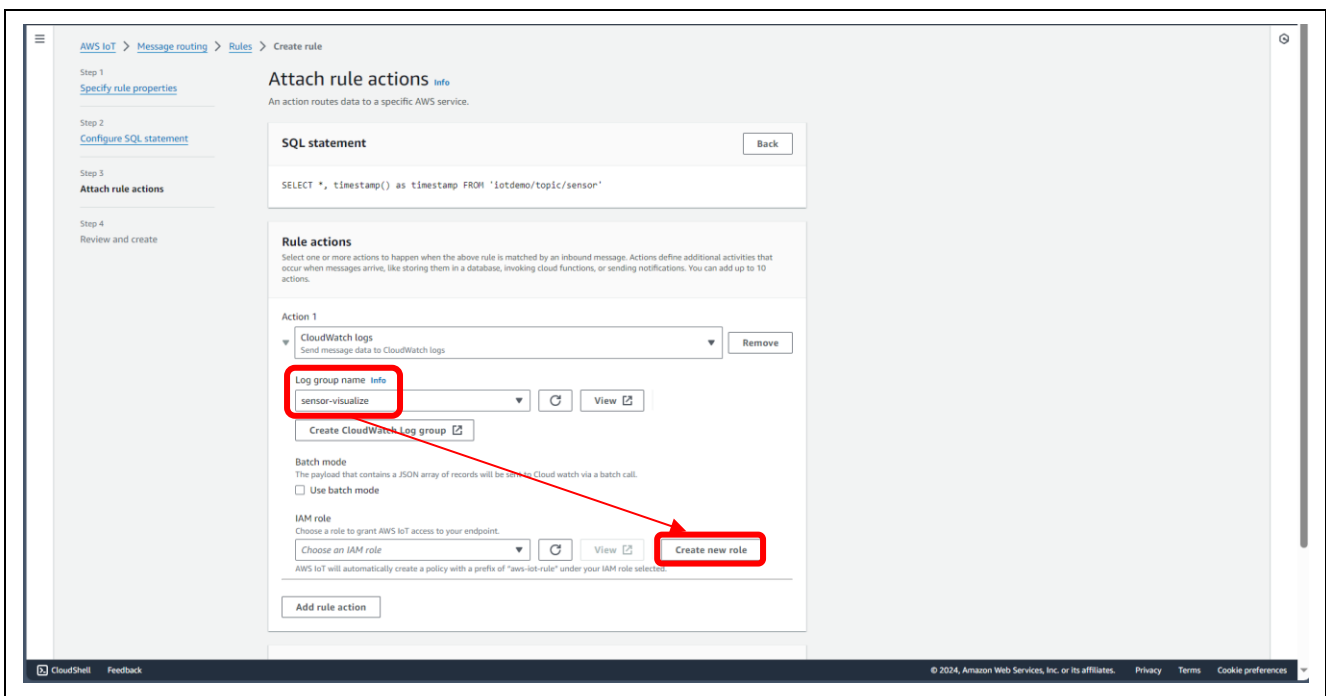

(7) Selecting the created IAM role

Select the created role in [IAM role].

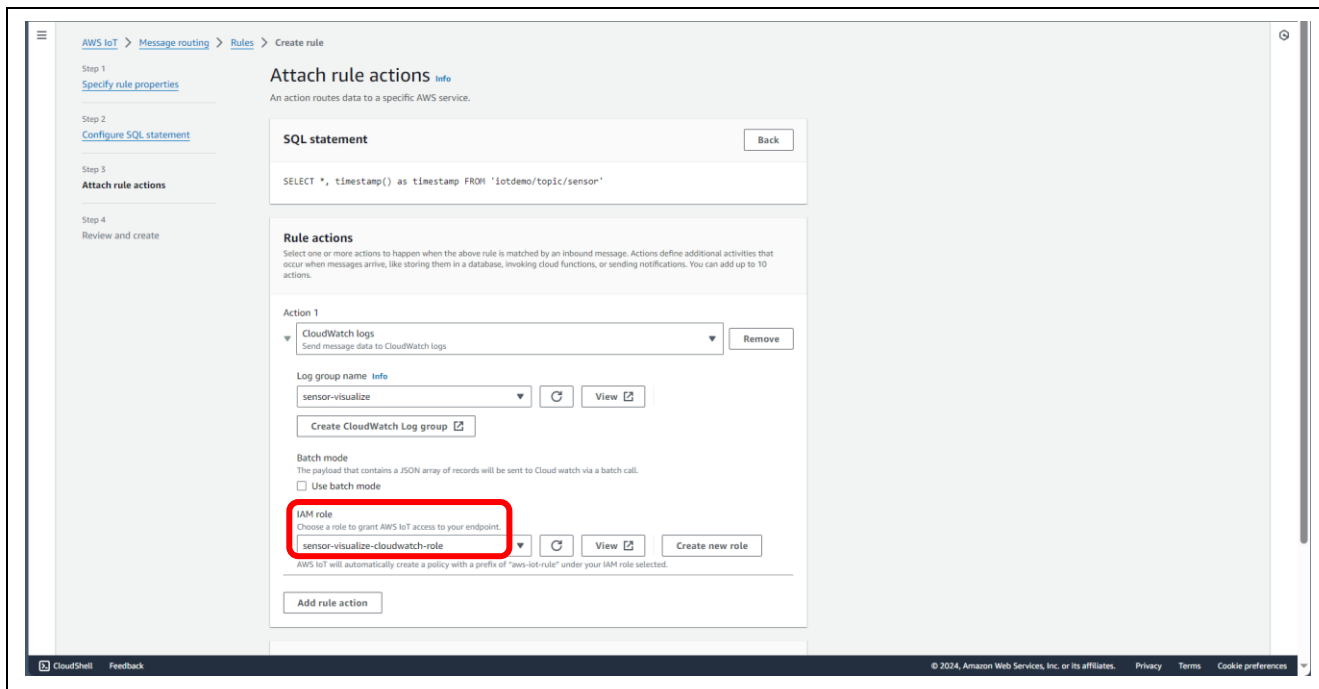

(8) Confirming successful creation of the rule

Click on [Next] and then click on [Create] on the subsequent page. Finally, confirm that the created rule is displayed in the list of rules.

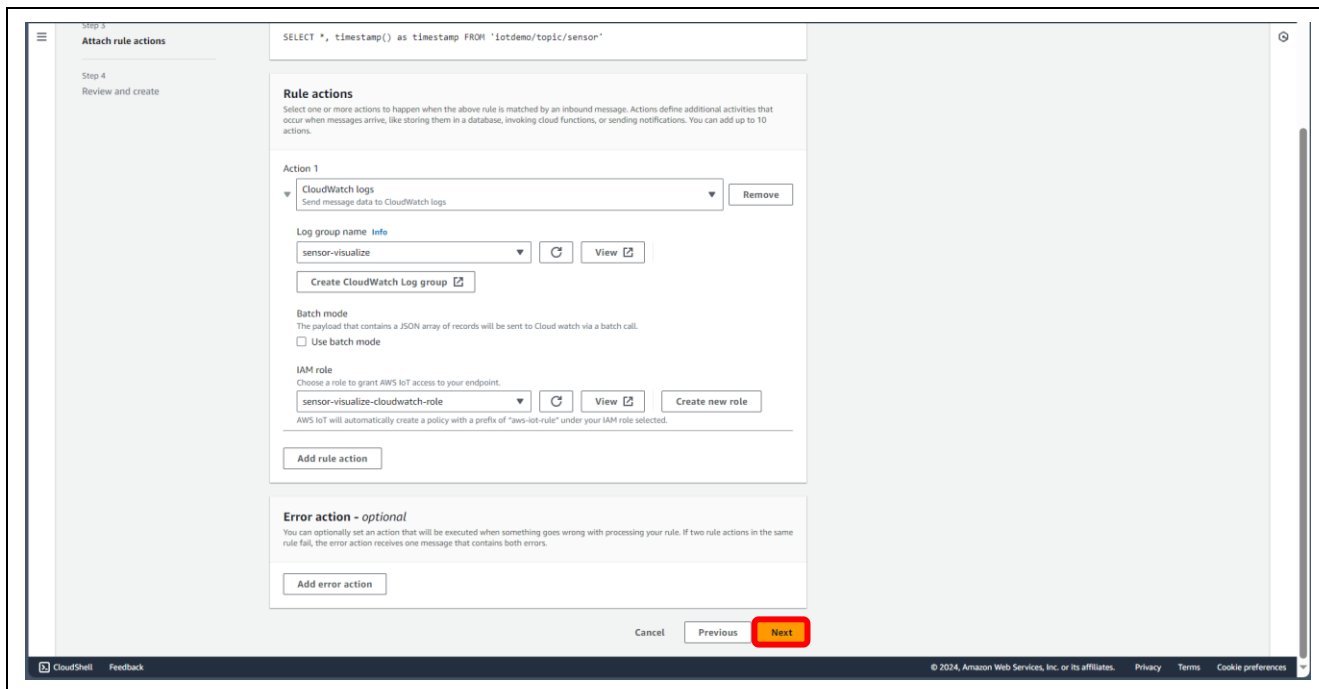

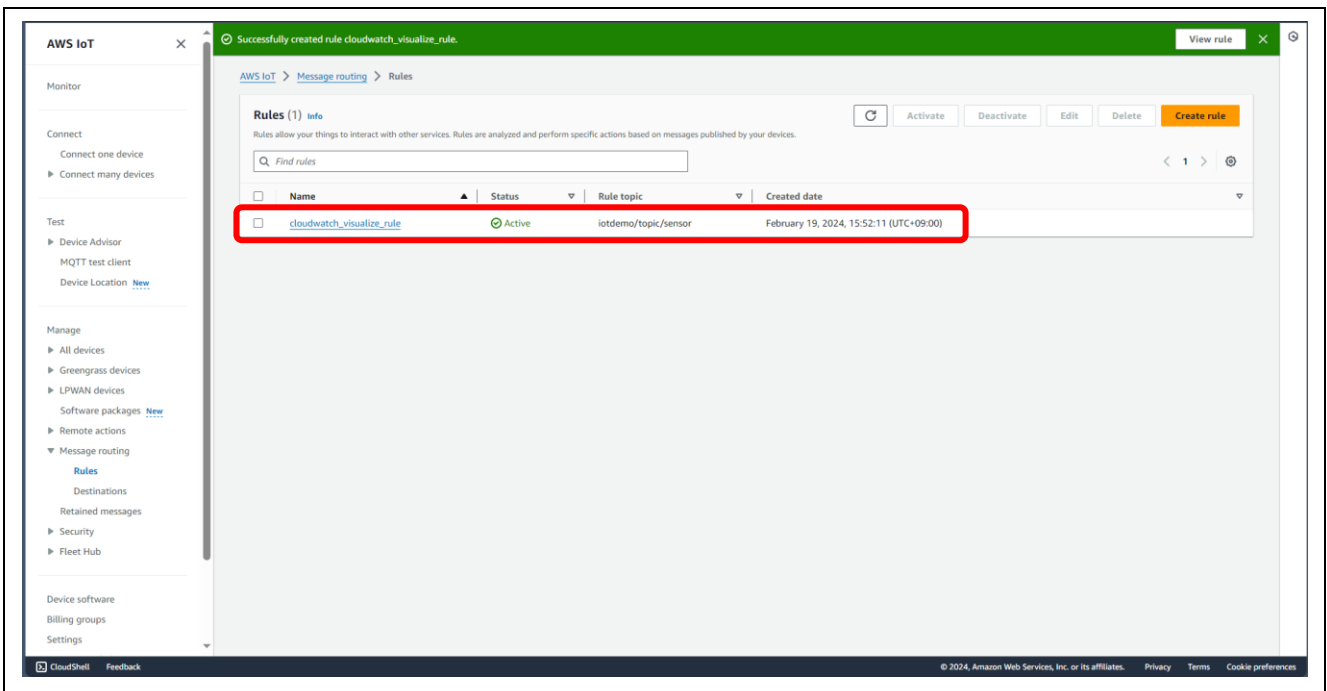
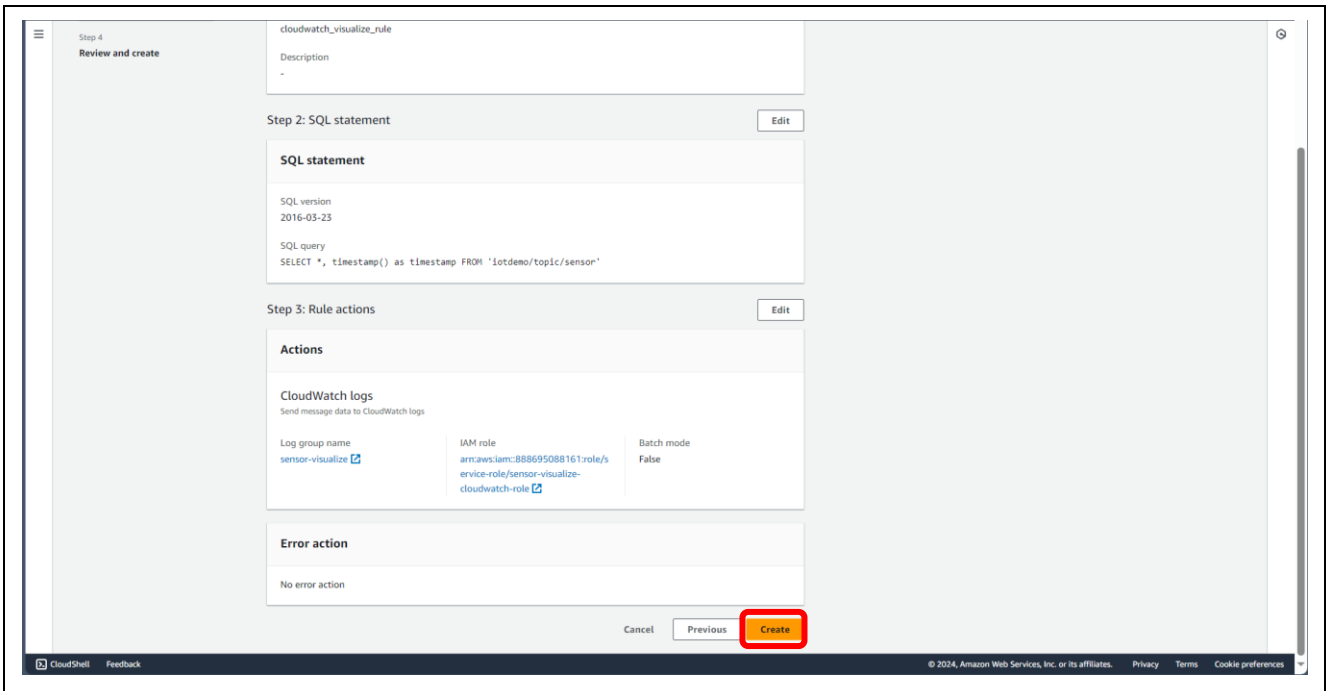

(9) Checking the graphical display in Amazon CloudWatch

Display the screen of Amazon CloudWatch and click on [Logs Insights] on the menu at left.

Select the group that was created in 6.3.2.1(5) as the log group, enter the following query, and click on [Run query].

```
stats avg(hs300x_humidity), avg(hs300x_temperature) by bin(1m)
```

A graph is displayed on the [Visualization] tabbed page.

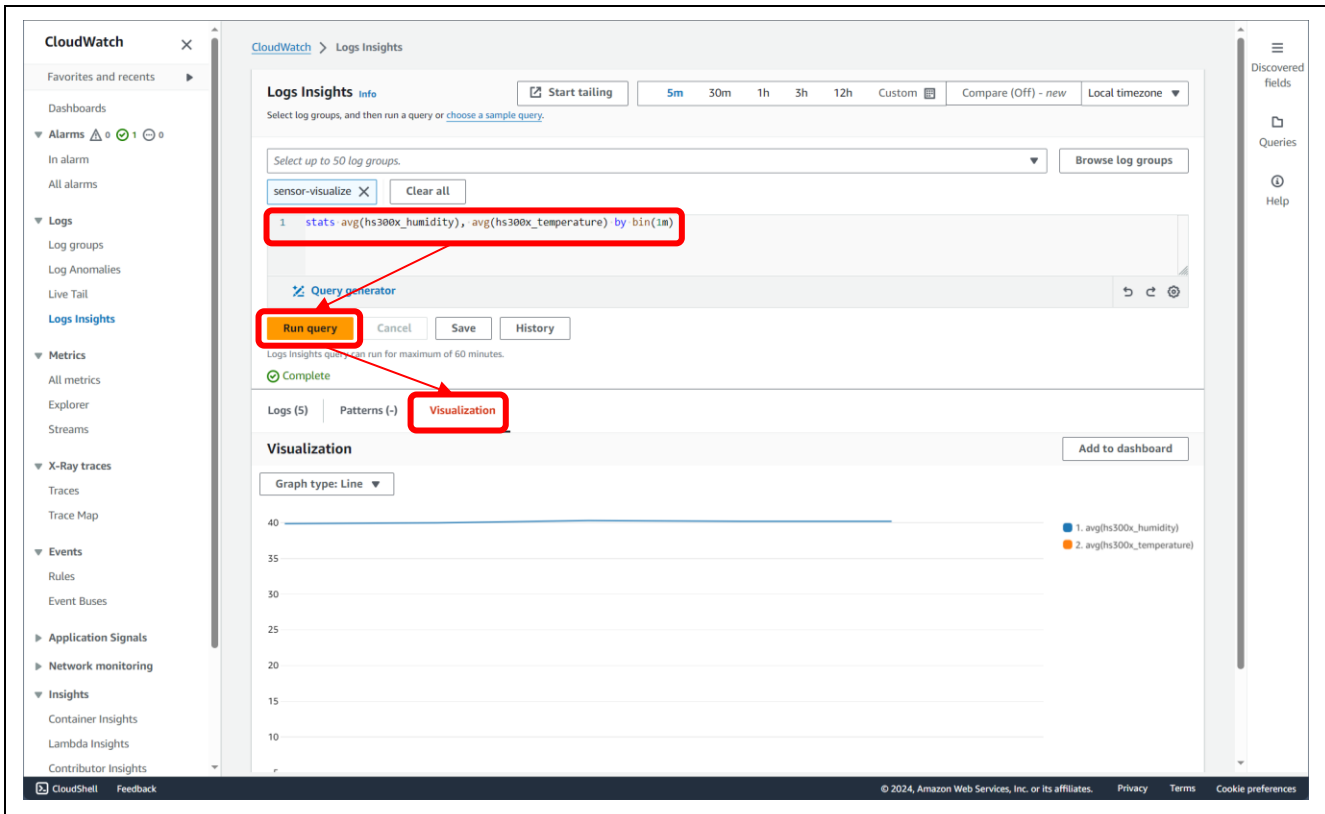

## 7. Procedure for Running the Demonstration

The procedure for running the demonstration is described below.

### 7.1 Checking the Initial State of Operation

With the setup for the demonstration described in section 6 completed, press the reset switch (RESET) on the TB-RX660 to apply a hardware reset. Similarly, press the reset switch (S1) on the CK-RX65N to apply a hardware reset.

Check the logs from each of the microcontrollers by using terminal software.

Figure 7-1 shows the log screen of the CK-RX65N. Confirm that humidity data from the HS3001 sensor are being output. Below that, you can also see the log of sensor data being sent to AWS via MQTT communications.

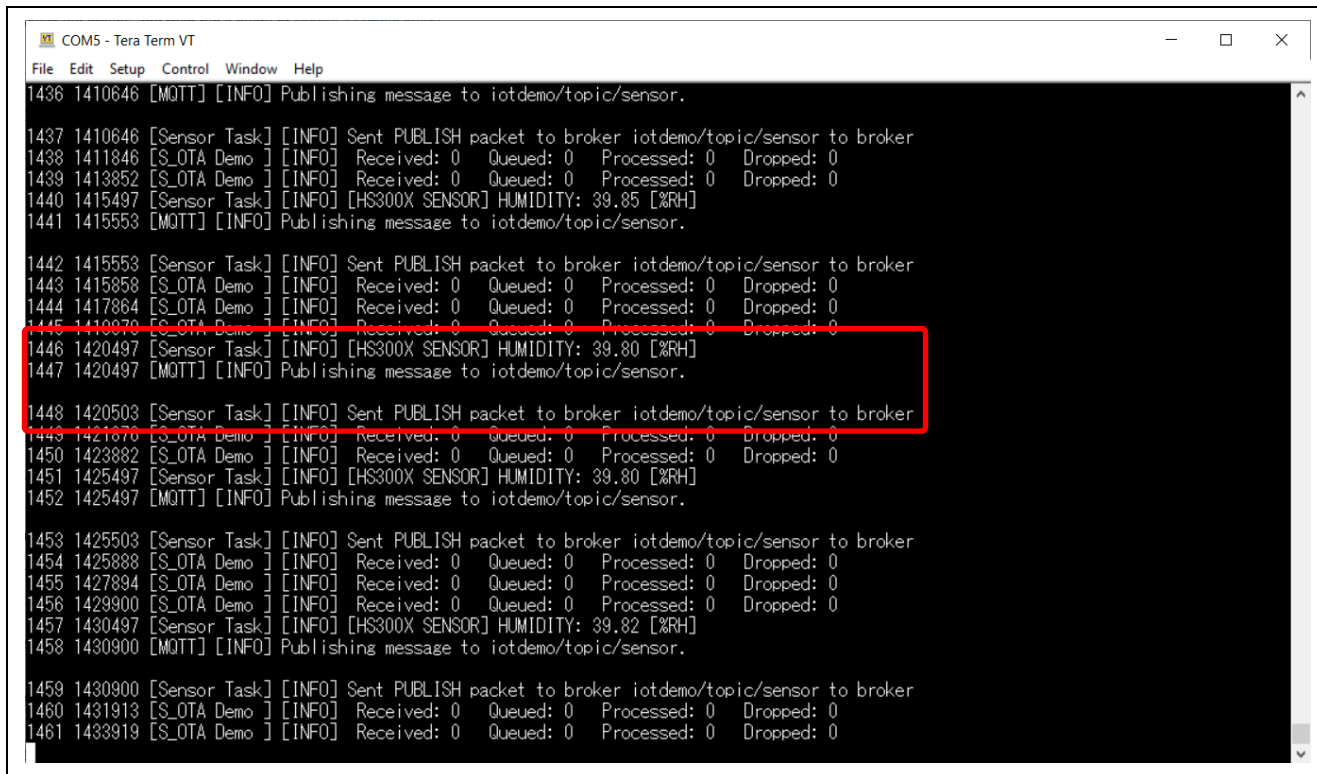

Figure 7-1 Log Screen of the CK-RX65N

Next, Figure 7-2 shows the log screen of the TB-RX660. Confirm that only the humidity data from the HS3001 sensor are displayed.

In the initial state, LED0 of the TB-RX660 is blinking.

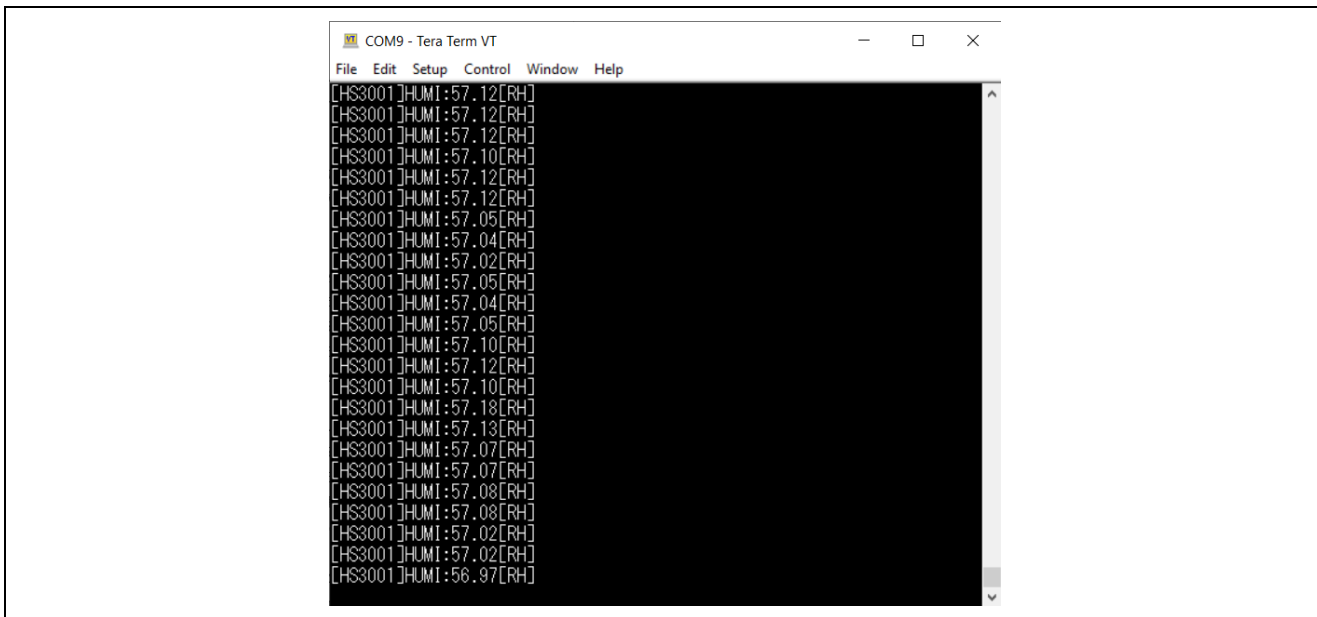

Figure 7-2 Log Screen of the TB-RX660

Finally, Figure 7-3 shows the display for Amazon CloudWatch. Confirm that the humidity data acquired from the HS3001 sensor are displayed as a graph.

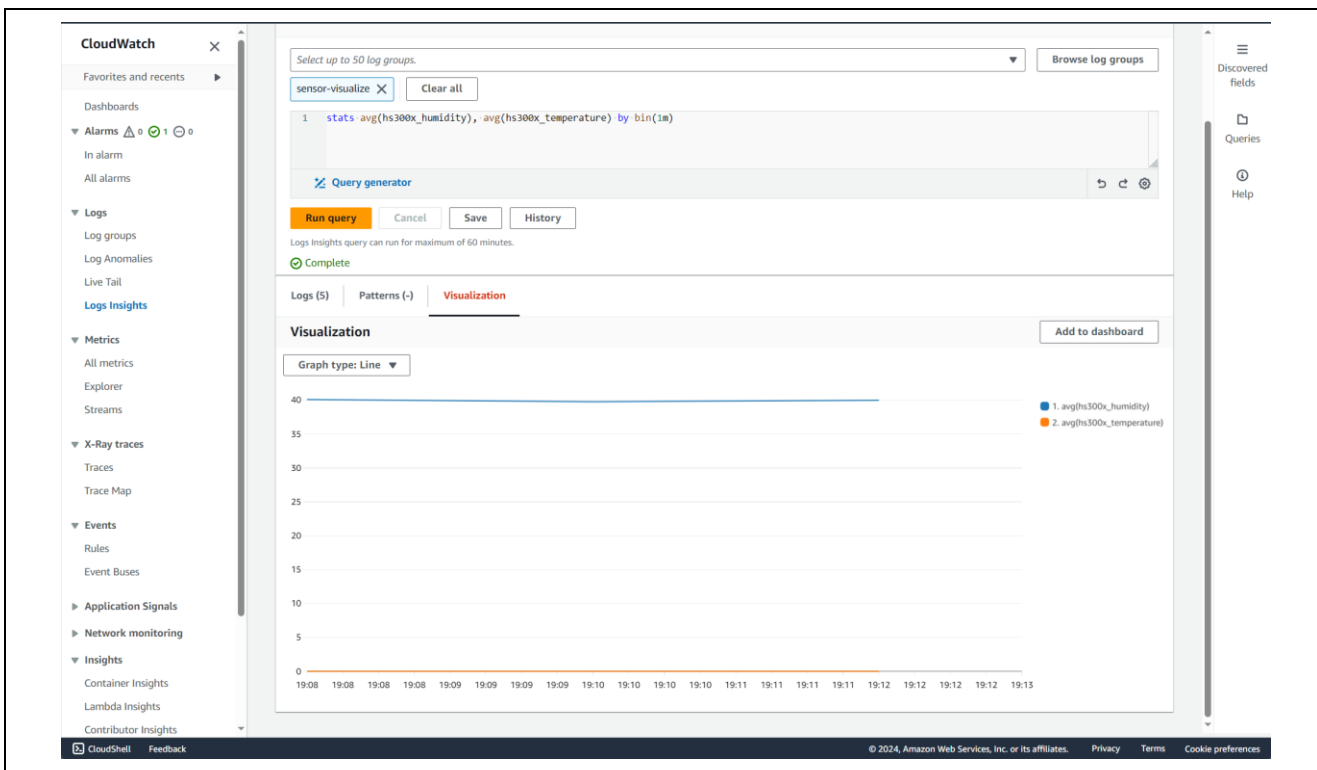

Figure 7-3 Graphical Display of Amazon CloudWatch before the Secondary OTA Update

This is the initial state before the secondary OTA update is run.



## 7.2 Executing the OTA Update of the TB-RX660

### 7.2.1 Creating the Update Firmware

(1) Changing the source code of the rx660\_tb\_2ndota\_demo project

Set the MEASURE\_TEMPERATURE macro of rx660\_tb\_2ndota\_demo/src/rx660\_tb\_2ndota\_demo.c to 1.

The version values displayed in the log at execution can be changed by changing DEMO\_VER\_MAJOR, DEMO\_VER\_MINOR, and DEMO\_VER\_BUILD, which are displayed below the above macro.

```
#define MEASURE_HUMIDITY (1)
#define MEASURE_TEMPERATURE (1)

#define DEMO_VER_MAJOR (2)
#define DEMO_VER_MINOR (0)
#define DEMO_VER_BUILD (0)
```

(2) Creating the update firmware (MOT file format)

Build the rx660\_tb\_2ndota\_demo project and create a MOT file.

(3) Creating the update firmware (RSU file format)

Convert the created rx660\_tb\_2ndota\_demo MOT file into update firmware in the RSU format by using the Renesas Image Generator.

Run the following command in the rx660\_tb\_2ndota\_demo\RenesasImageGenerator folder to create the RSU-format update firmware "update\_firm.rsu".

```
> python .\image-gen.py -iup ..\HardwareDebug\rx660_tb_2ndota_demo.mot -o .\update_firm
-key .\keys\secp256r1.privatekey -ip .\RX660_Linear_Half_ImageGenerator_PRM.csv -vt
ecdsa
```

### 7.2.2 Creating an OTA Job in AWS

- (1) Sign in to the AWS Management Console and select [Services] in the upper-left corner, then select [Internet of Things] → [IoT Core].

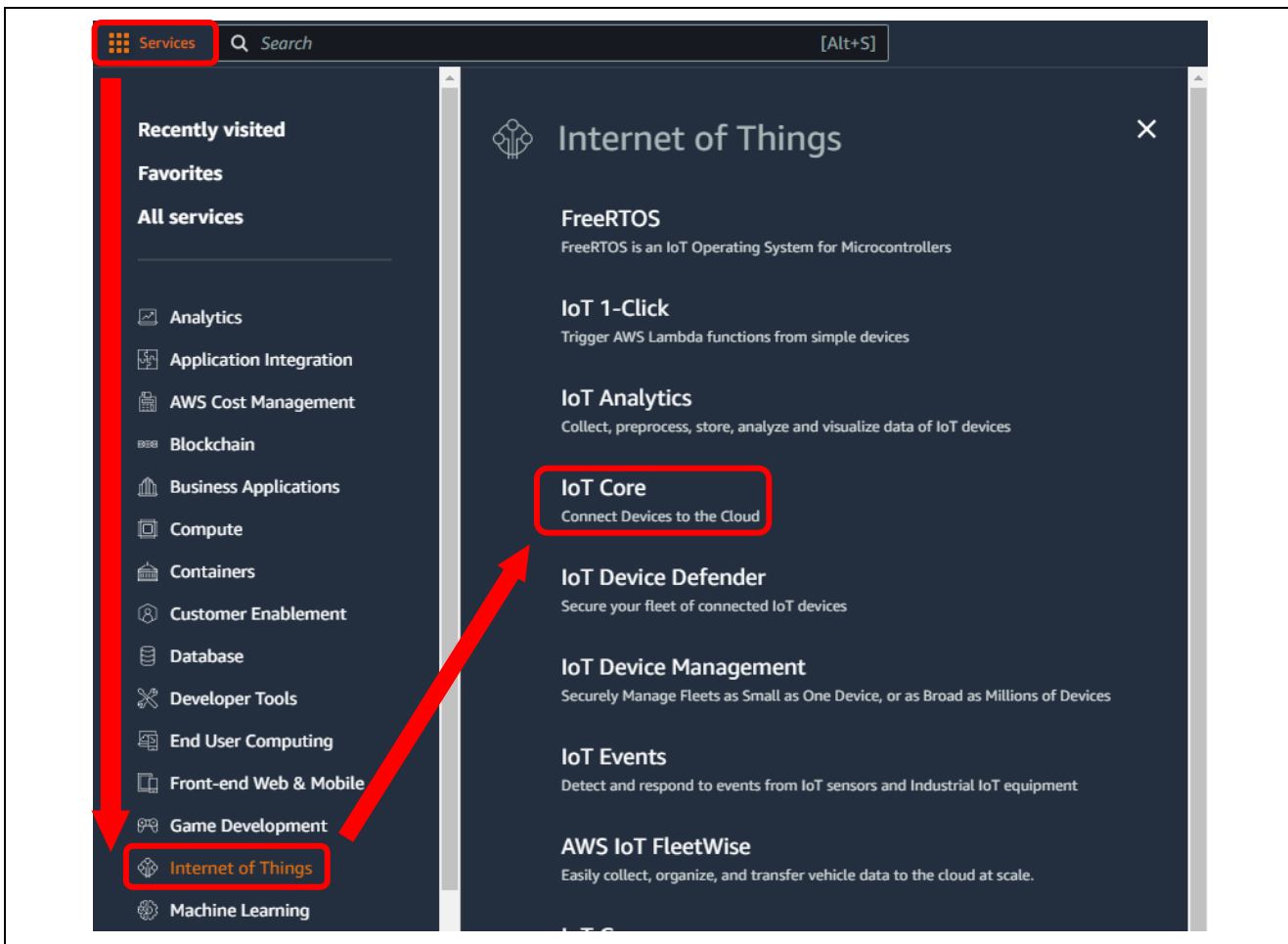

Figure 7-4 Window of Services of AWS

(2) Select [Remote action] → [Jobs] from the menu at left in AWS IoT Core and click on [Create job].

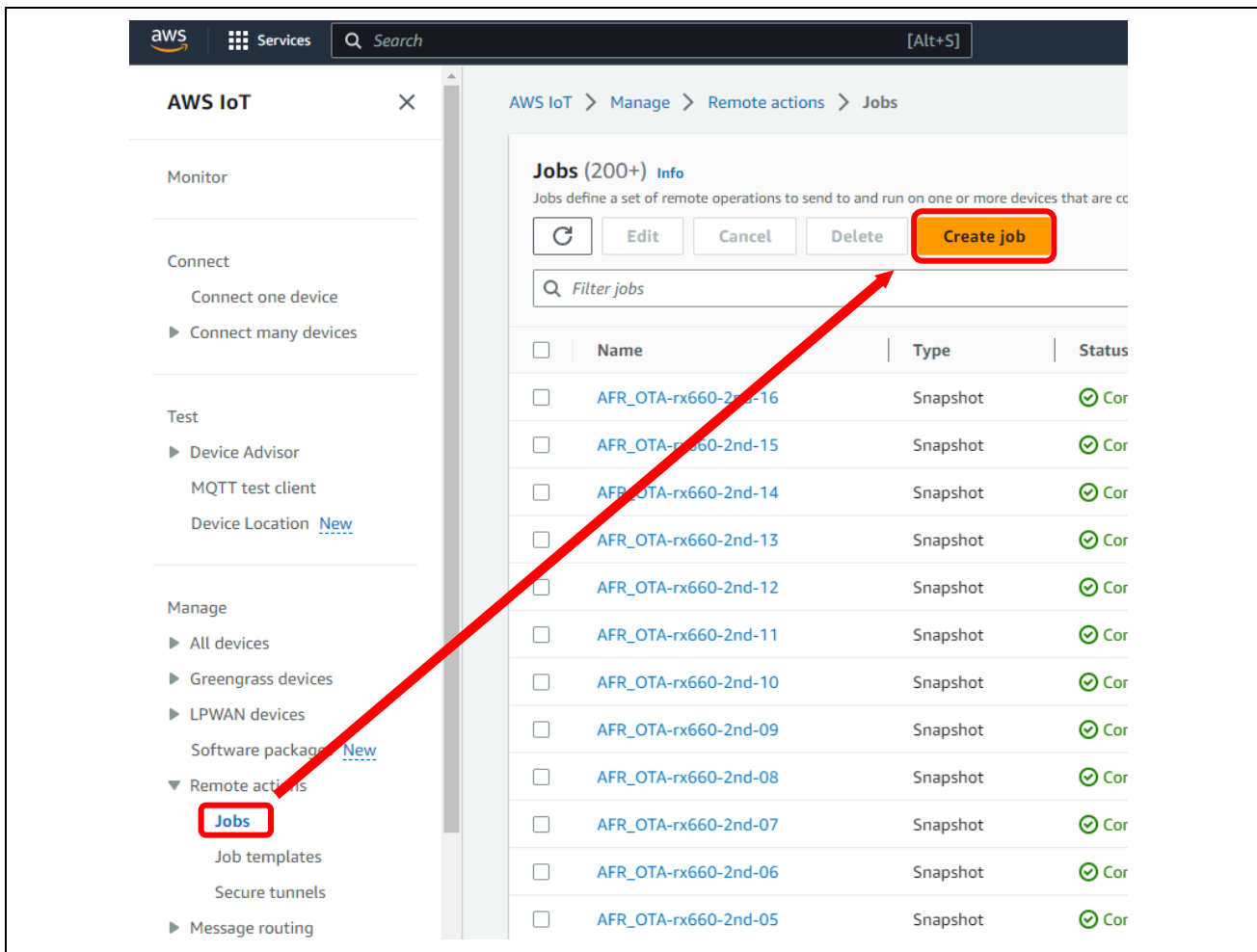

Figure 7-5 Window of AWS IoT Core

(3) On the [Create job] page, select “Create FreeRTOS OTA update job” and click on [Next].

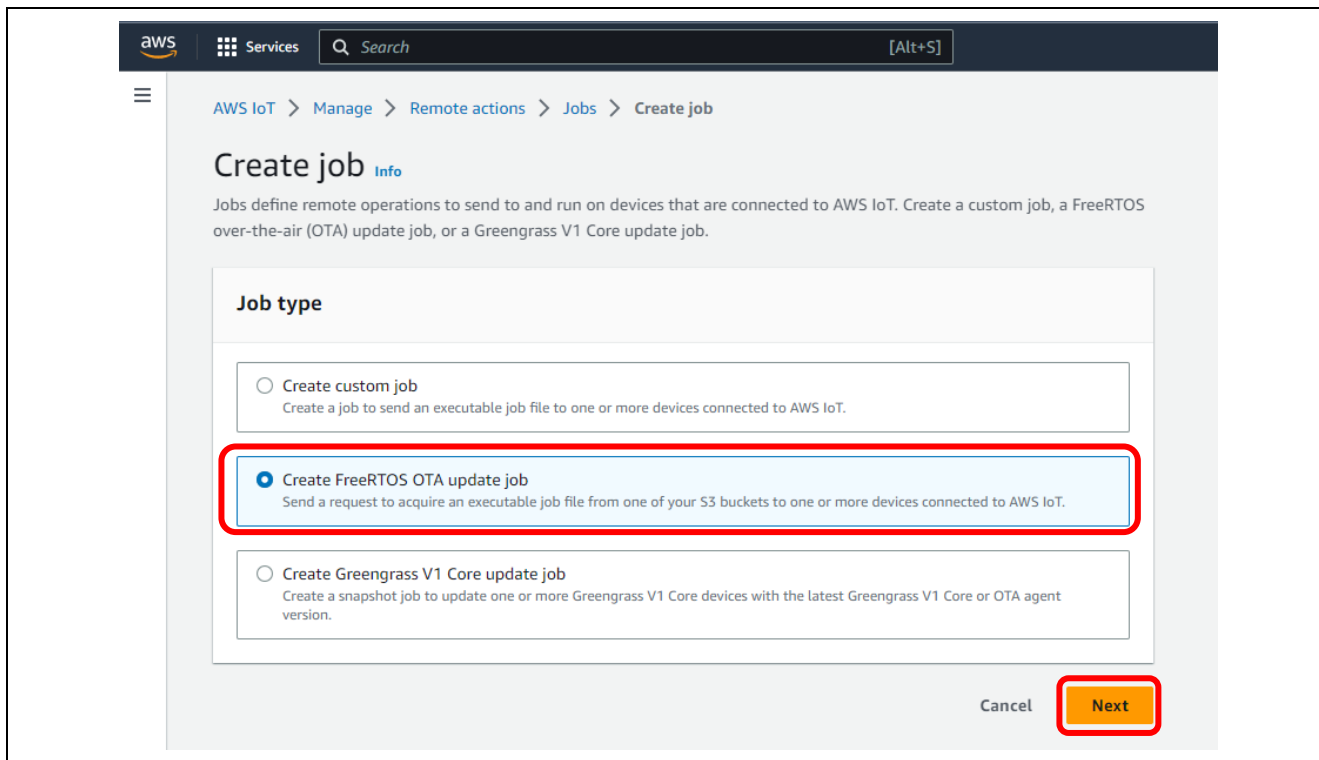

Figure 7-6 Page for Creating a Job

(4) On the [OTA job properties] page, enter a job name in [Job name] and click on [Next].

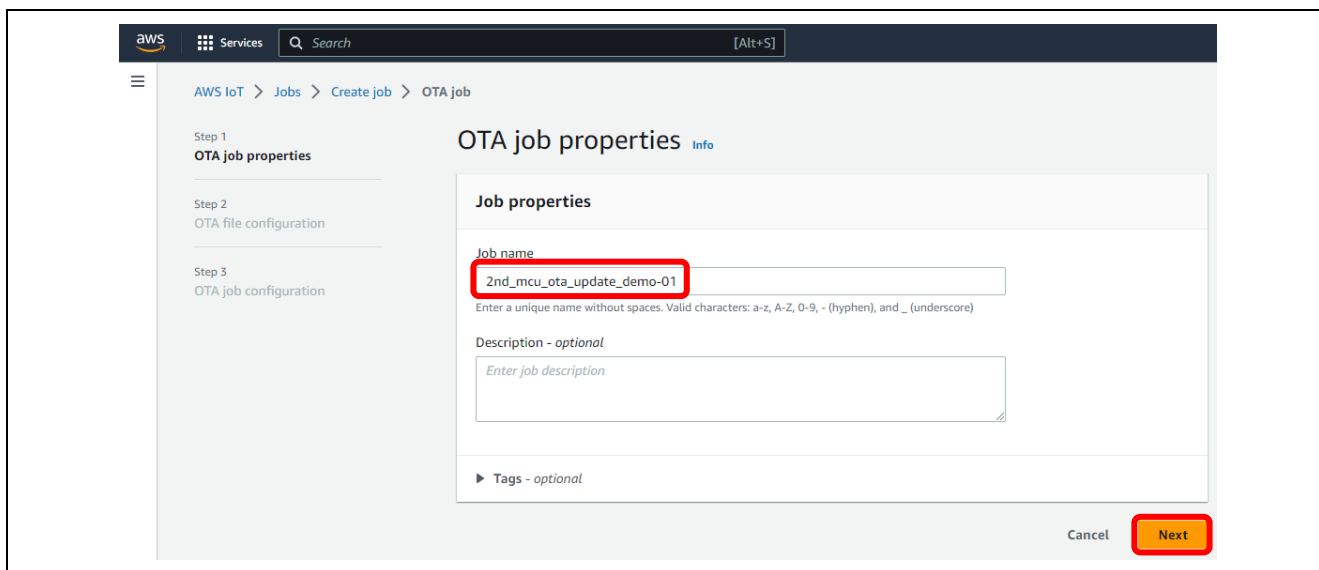

Figure 7-7 Page for Entering the Properties of the OTA Job

(5) Enter the various items indicated below on the [OTA file configuration] page.

1. In [Devices to update], select the IoT device name that was set in QE for OTA in 6.2.3(6).
2. In [Select the protocol for file transfer], select "MQTT".
3. In [Sign and choose your file], select "Sign a new file for me".
4. In [Code signing profile], select the code signing profile that was created in 6.3.1(3).

**Note:** The code signing certificate profile specified here is not used for code signing verification of the firmware of the secondary MCU, so any profile can be specified. The code signing will be written in the RSU file of the update firmware when it is created by the Renesas Image Generator.

5. In [File], select "Upload a new file."
6. In [File to upload], click on [Choose file] and select the firmware (.rsu format) that was created in 7.2.1 for use in updating the TB-RX660.
7. In [S3 URL], click on [Browse S3] and select the Amazon S3 bucket that was set in 6.3.1(1).
8. In [Path name of file on device], enter a desired string of characters.
9. In [File type], enter "1".
10. In [Role], select the service role for the OTA update that was set in 6.3.1(2).

After entering the above, click on [Next].

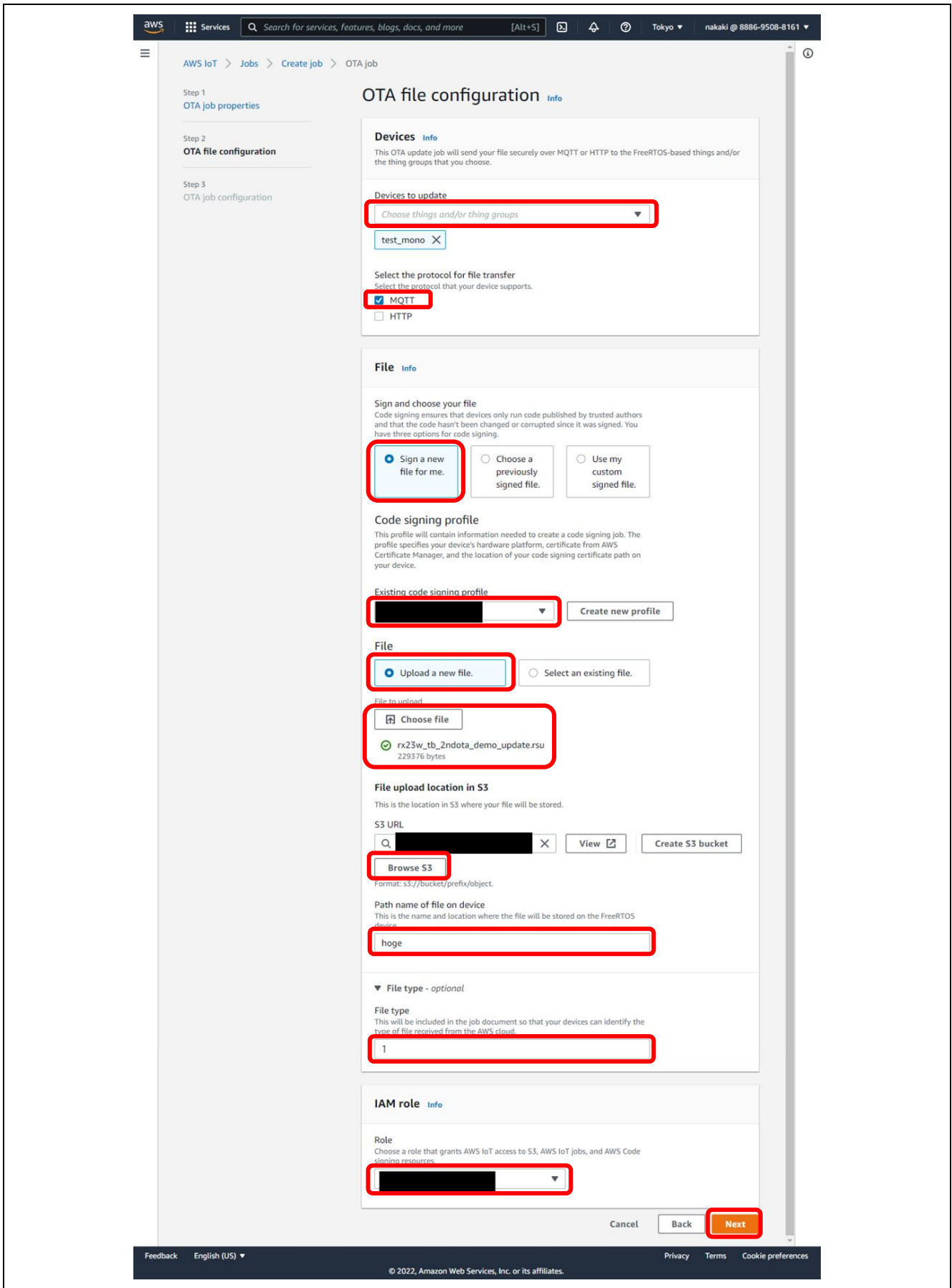

Figure 7-8 Page for Setting up the OTA File

(6) Just click on [Create job] on the [OTA job configuration] page as it is not necessary to make any changes.

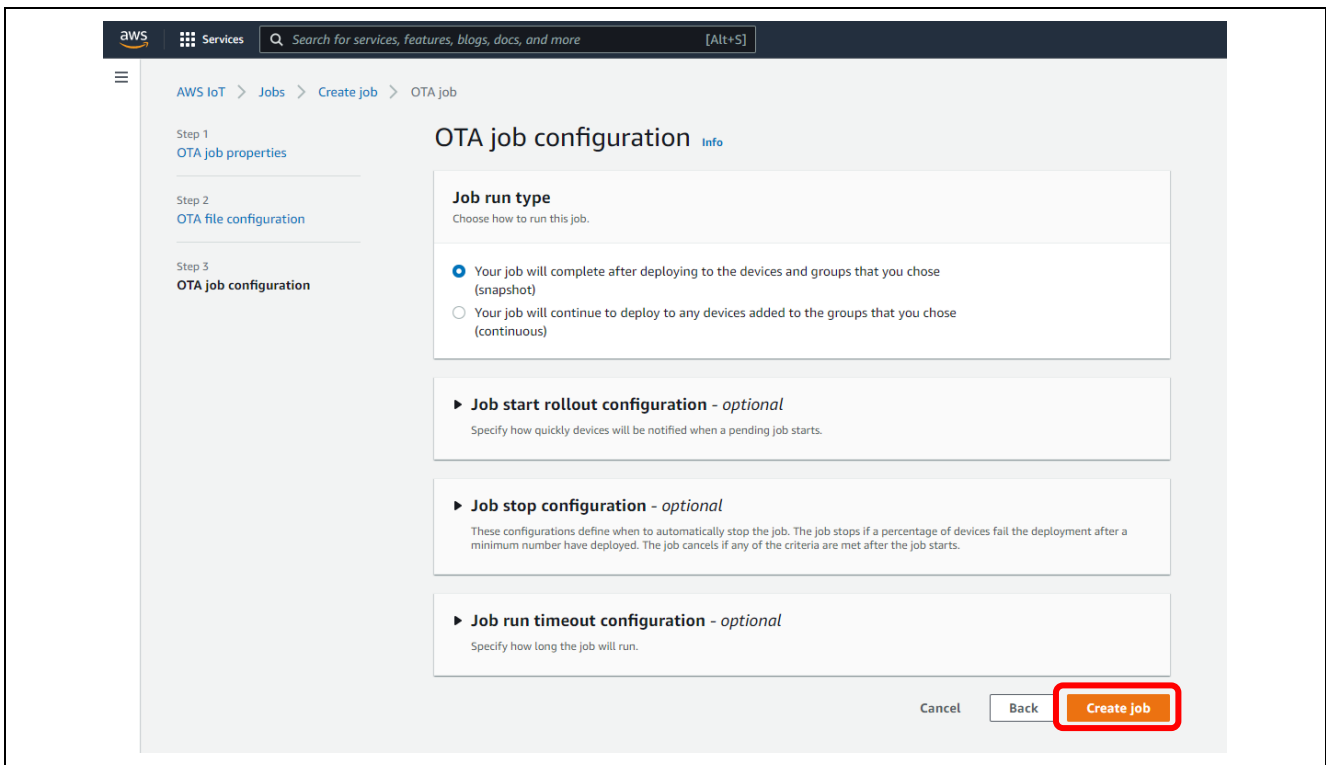

Figure 7-9 Page for Setting up the OTA Job

An OTA job for the secondary OTA update is created by following the above steps, and the OTA job is delivered to the specified device.

### 7.2.3 Checking Operation during Execution of the Secondary OTA Update

The OTA update starts within a few seconds after creation of the job. Both the CK-RX65N and TB-RX660 will output logs of the progress of the secondary OTA update.

### 7.3 Checking Operation after the OTA Update

Figure 7-10 shows the log screen of the CK-RX65N after the update.

You can see that the temperature data are newly displayed in addition to the humidity data acquired from the HS3001 sensor.

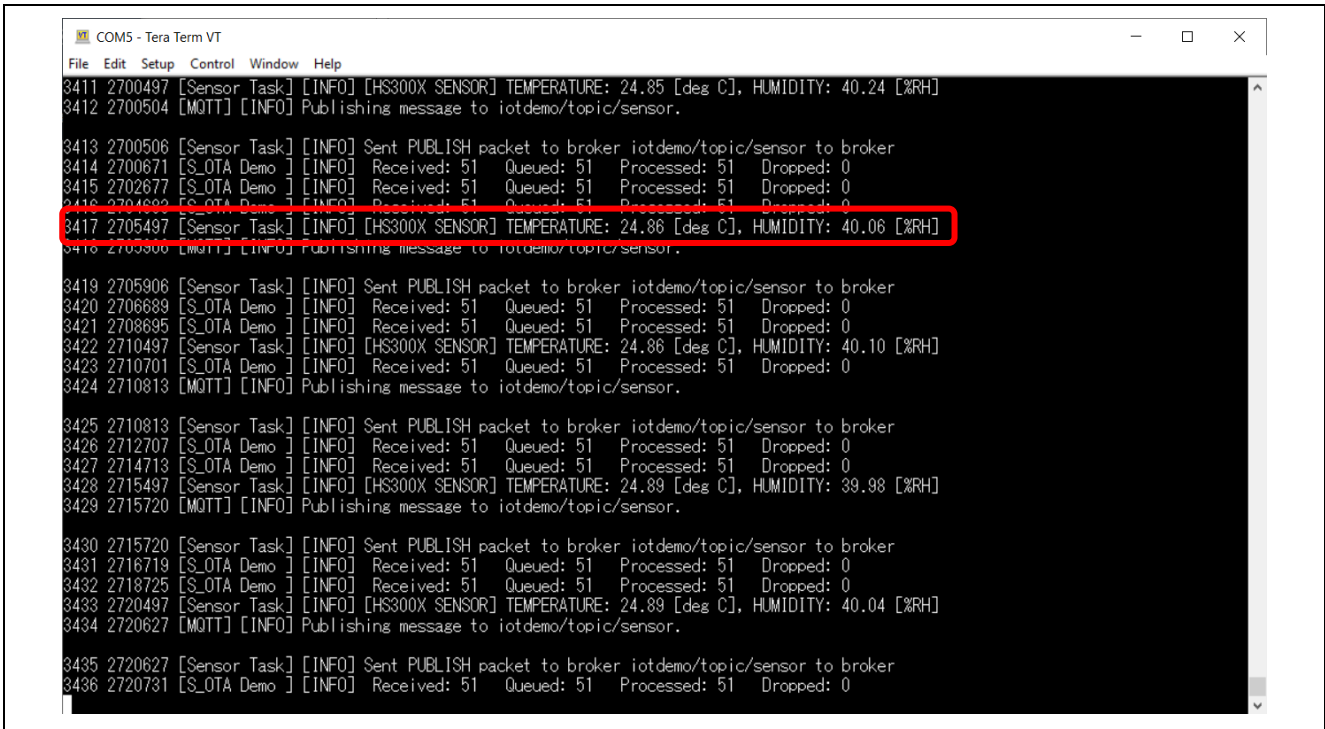

Figure 7-10 Log Screen of the CK-RX65N after the Firmware Update

Next, Figure 7-11 shows the log output for the TB-RX660 after the update. If the firmware update of the TB-RX660 was successful, measured humidity and temperature data are acquired from the HS3001 sensor.

In addition to LED0 that was blinking in the initial state, LED1 will now also be blinking.

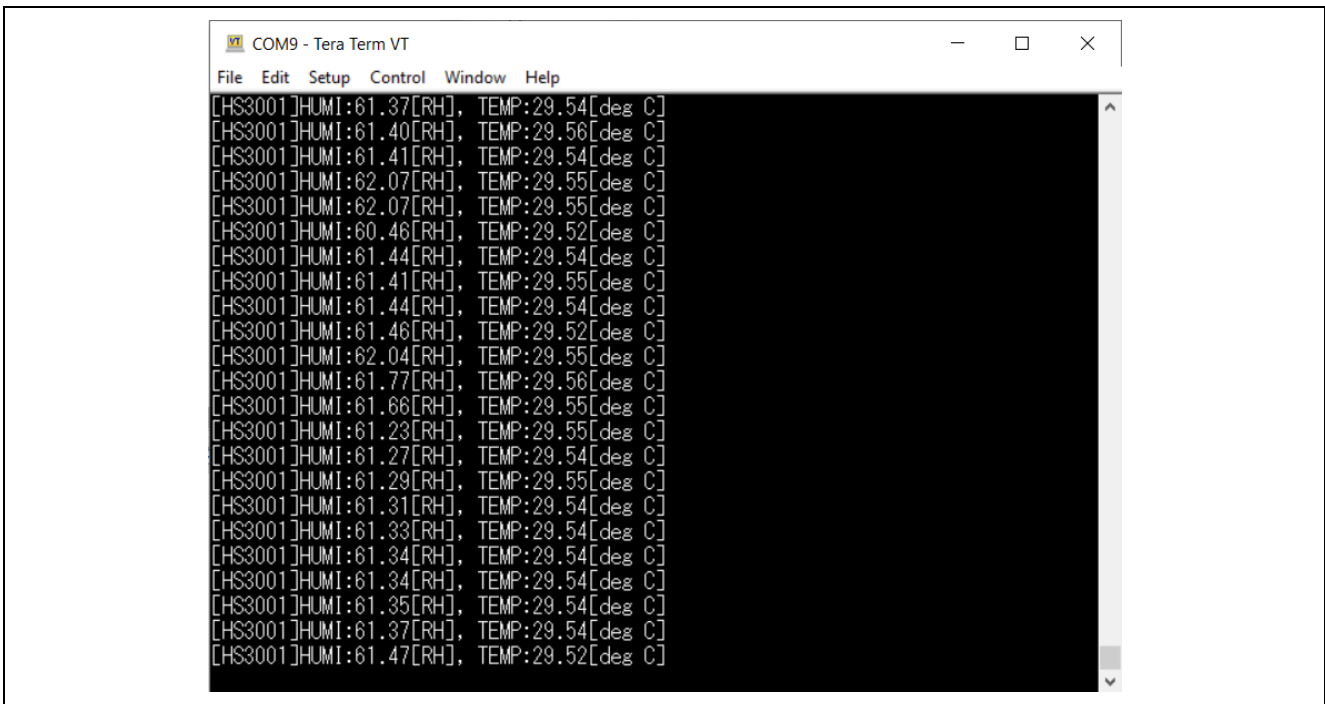
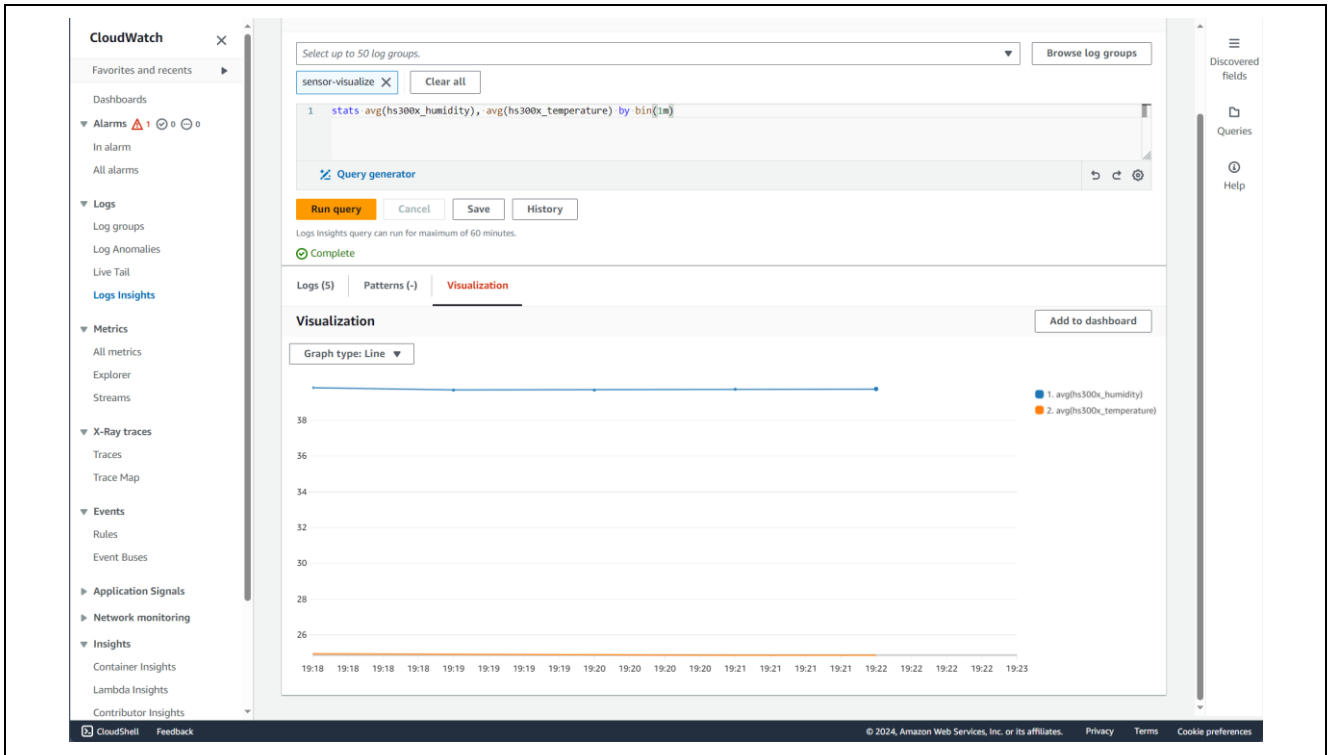

Figure 7-11 Log Screen of the TB-RX660 after the Firmware Update



Finally, Figure 7-12 shows the display for Amazon CloudWatch. Confirm that the measured temperature and humidity data acquired from the HS3001 sensor are displayed as a graph.



**Figure 7-12 Graphical Display of Amazon CloudWatch after the Secondary OTA Update**

Operations for the demonstration are completed at this point.

## 8. Precautions

### 8.1 License Information on the Open-Source Software in Use

The following open-source software is used.

- TinyCrypt Cryptographic Library
  - URL: <https://01.org/tinycrypt>
  - License: <https://github.com/intel/tinycrypt/blob/master/LICENSE>
- FreeRTOS
  - URL: <https://www.freertos.org/>
  - License: [FreeRTOS open source licensing, FreeRTOS license description, FreeRTOS license terms and OpenRTOS commercial licensing options.](#)

### 8.2 Region and User Privileges of AWS for the Demonstration

Regarding the setup of AWS for running the demonstration, notes on the region of use and user privileges are given below.

<Region of use>

This demonstration is provided in the ap-northeast-1 (Asia Pacific (Tokyo)) region of AWS.

If you want to run this demonstration in another region, confirm that the services used in the demonstration are available in that region beforehand.

<User privileges>

This demonstration is to be run by a user with Administrator Access permission in the AWS Identity and Access Management (IAM) system. Therefore, there is no particular description regarding the granting of necessary permissions in IAM when using various services.

### 8.3 Fees for Using AWS

A charge may apply to the cloud resources created and used in the demonstration depending on how AWS is used. To avoid inadvertently incurring charges, deleting the resources created in the cloud after running the demonstration is recommended.

## Revision History

Rev.	Date	Description	
		Page	Summary
1.01	Jan. 24, 2022	—	First edition issued.
1.10	Mar. 31, 2022	—	Supported AWS IoT Over-the-air Update Library v3.0.0.
		5 - 8	Added .settings folder to the folder structure of each project.
		5 - 8	Revised package and folder structure for RX65N project.
		9	Updated IDE environment to e2studio 2022-01, Toolchain to CC-RX V3.04.00 and FreeRTOS for RX65N project to Version 2021.07.
		9	Updated code size.
		19 - 20	Updated initial firmware creation method due to RX65N project changes.
		47	Updated screenshot of output log due to RX65N project changes.
		51 - 55	Changed the method of executing an update.
		56	Updated screenshot of output log due to RX65N project changes.
2.00	Mar. 31, 2024	—	The used boards were changed to the CK-RX65N and TB-RX660.
		—	The FreeRTOS package for the projects for the RX65N was updated.
		—	The version of the firmware update module (FWUP) using Firmware Integration Technology (FIT) for the projects for the RX660 was updated.
		—	The entire application note was revised due to changes in the used boards and projects.

# General Precautions in the Handling of Microprocessing Unit and Microcontroller Unit Products

The following usage notes are applicable to all Microprocessing unit and Microcontroller unit products from Renesas. For detailed usage notes on the products covered by this document, refer to the relevant sections of the document as well as any technical updates that have been issued for the products.

## 1. Precaution against Electrostatic Discharge (ESD)

A strong electrical field, when exposed to a CMOS device, can cause destruction of the gate oxide and ultimately degrade the device operation. Steps must be taken to stop the generation of static electricity as much as possible, and quickly dissipate it when it occurs. Environmental control must be adequate. When it is dry, a humidifier should be used. This is recommended to avoid using insulators that can easily build up static electricity.

Semiconductor devices must be stored and transported in an anti-static container, static shielding bag or conductive material. All test and measurement tools including work benches and floors must be grounded. The operator must also be grounded using a wrist strap. Semiconductor devices must not be touched with bare hands. Similar precautions must be taken for printed circuit boards with mounted semiconductor devices.

## 2. Processing at power-on

The state of the product is undefined at the time when power is supplied. The states of internal circuits in the LSI are indeterminate and the states of register settings and pins are undefined at the time when power is supplied. In a finished product where the reset signal is applied to the external reset pin, the states of pins are not guaranteed from the time when power is supplied until the reset process is completed. In a similar way, the states of pins in a product that is reset by an on-chip power-on reset function are not guaranteed from the time when power is supplied until the power reaches the level at which resetting is specified.

## 3. Input of signal during power-off state

Do not input signals or an I/O pull-up power supply while the device is powered off. The current injection that results from input of such a signal or I/O pull-up power supply may cause malfunction and the abnormal current that passes in the device at this time may cause degradation of internal elements. Follow the guideline for input signal during power-off state as described in your product documentation.

## 4. Handling of unused pins

Handle unused pins in accordance with the directions given under handling of unused pins in the manual. The input pins of CMOS products are generally in the high-impedance state. In operation with an unused pin in the open-circuit state, extra electromagnetic noise is induced in the vicinity of the LSI, an associated shoot-through current flows internally, and malfunctions occur due to the false recognition of the pin state as an input signal become possible.

## 5. Clock signals

After applying a reset, only release the reset line after the operating clock signal becomes stable. When switching the clock signal during program execution, wait until the target clock signal is stabilized. When the clock signal is generated with an external resonator or from an external oscillator during a reset, ensure that the reset line is only released after full stabilization of the clock signal. Additionally, when switching to a clock signal produced with an external resonator or by an external oscillator while program execution is in progress, wait until the target clock signal is stable.

## 6. Voltage application waveform at input pin

Waveform distortion due to input noise or a reflected wave may cause malfunction. If the input of the CMOS device stays in the area between  $V_{IL}$  (Max.) and  $V_{IH}$  (Min.) due to noise, for example, the device may malfunction. Take care to prevent chattering noise from entering the device when the input level is fixed, and also in the transition period when the input level passes through the area between  $V_{IL}$  (Max.) and  $V_{IH}$  (Min.).

## 7. Prohibition of access to reserved addresses

Access to reserved addresses is prohibited. The reserved addresses are provided for possible future expansion of functions. Do not access these addresses as the correct operation of the LSI is not guaranteed.

## 8. Differences between products

Before changing from one product to another, for example to a product with a different part number, confirm that the change will not lead to problems. The characteristics of a microprocessing unit or microcontroller unit products in the same group but having a different part number might differ in terms of internal memory capacity, layout pattern, and other factors, which can affect the ranges of electrical characteristics, such as characteristic values, operating margins, immunity to noise, and amount of radiated noise. When changing to a product with a different part number, implement a system-evaluation test for the given product.

## Notice

1. Descriptions of circuits, software and other related information in this document are provided only to illustrate the operation of semiconductor products and application examples. You are fully responsible for the incorporation or any other use of the circuits, software, and information in the design of your product or system. Renesas Electronics disclaims any and all liability for any losses and damages incurred by you or third parties arising from the use of these circuits, software, or information.
2. Renesas Electronics hereby expressly disclaims any warranties against and liability for infringement or any other claims involving patents, copyrights, or other intellectual property rights of third parties, by or arising from the use of Renesas Electronics products or technical information described in this document, including but not limited to, the product data, drawings, charts, programs, algorithms, and application examples.
3. No license, express, implied or otherwise, is granted hereby under any patents, copyrights or other intellectual property rights of Renesas Electronics or others.
4. You shall be responsible for determining what licenses are required from any third parties, and obtaining such licenses for the lawful import, export, manufacture, sales, utilization, distribution or other disposal of any products incorporating Renesas Electronics products, if required.
5. You shall not alter, modify, copy, or reverse engineer any Renesas Electronics product, whether in whole or in part. Renesas Electronics disclaims any and all liability for any losses or damages incurred by you or third parties arising from such alteration, modification, copying or reverse engineering.
6. Renesas Electronics products are classified according to the following two quality grades: "Standard" and "High Quality". The intended applications for each Renesas Electronics product depends on the product's quality grade, as indicated below.

"Standard": Computers; office equipment; communications equipment; test and measurement equipment; audio and visual equipment; home electronic appliances; machine tools; personal electronic equipment; industrial robots; etc.

"High Quality": Transportation equipment (automobiles, trains, ships, etc.); traffic control (traffic lights); large-scale communication equipment; key financial terminal systems; safety control equipment; etc.

Unless expressly designated as a high reliability product or a product for harsh environments in a Renesas Electronics data sheet or other Renesas Electronics document, Renesas Electronics products are not intended or authorized for use in products or systems that may pose a direct threat to human life or bodily injury (artificial life support devices or systems; surgical implantations; etc.), or may cause serious property damage (space system; undersea repeaters; nuclear power control systems; aircraft control systems; key plant systems; military equipment; etc.). Renesas Electronics disclaims any and all liability for any damages or losses incurred by you or any third parties arising from the use of any Renesas Electronics product that is inconsistent with any Renesas Electronics data sheet, user's manual or other Renesas Electronics document.
7. No semiconductor product is absolutely secure. Notwithstanding any security measures or features that may be implemented in Renesas Electronics hardware or software products, Renesas Electronics shall have absolutely no liability arising out of any vulnerability or security breach, including but not limited to any unauthorized access to or use of a Renesas Electronics product or a system that uses a Renesas Electronics product. RENESAS ELECTRONICS DOES NOT WARRANT OR GUARANTEE THAT RENESAS ELECTRONICS PRODUCTS, OR ANY SYSTEMS CREATED USING RENESAS ELECTRONICS PRODUCTS WILL BE INVULNERABLE OR FREE FROM CORRUPTION, ATTACK, VIRUSES, INTERFERENCE, HACKING, DATA LOSS OR THEFT, OR OTHER SECURITY INTRUSION ("Vulnerability Issues"). RENESAS ELECTRONICS DISCLAIMS ANY AND ALL RESPONSIBILITY OR LIABILITY ARISING FROM OR RELATED TO ANY VULNERABILITY ISSUES. FURTHERMORE, TO THE EXTENT PERMITTED BY APPLICABLE LAW, RENESAS ELECTRONICS DISCLAIMS ANY AND ALL WARRANTIES, EXPRESS OR IMPLIED, WITH RESPECT TO THIS DOCUMENT AND ANY RELATED OR ACCOMPANYING SOFTWARE OR HARDWARE, INCLUDING BUT NOT LIMITED TO THE IMPLIED WARRANTIES OF MERCHANTABILITY, OR FITNESS FOR A PARTICULAR PURPOSE.
8. When using Renesas Electronics products, refer to the latest product information (data sheets, user's manuals, application notes, "General Notes for Handling and Using Semiconductor Devices" in the reliability handbook, etc.), and ensure that usage conditions are within the ranges specified by Renesas Electronics with respect to maximum ratings, operating power supply voltage range, heat dissipation characteristics, installation, etc. Renesas Electronics disclaims any and all liability for any malfunctions, failure or accident arising out of the use of Renesas Electronics products outside of such specified ranges.
9. Although Renesas Electronics endeavors to improve the quality and reliability of Renesas Electronics products, semiconductor products have specific characteristics, such as the occurrence of failure at a certain rate and malfunctions under certain use conditions. Unless designated as a high reliability product or a product for harsh environments in a Renesas Electronics data sheet or other Renesas Electronics document, Renesas Electronics products are not subject to radiation resistance design. You are responsible for implementing safety measures to guard against the possibility of bodily injury, injury or damage caused by fire, and/or danger to the public in the event of a failure or malfunction of Renesas Electronics products, such as safety design for hardware and software, including but not limited to redundancy, fire control and malfunction prevention, appropriate treatment for aging degradation or any other appropriate measures. Because the evaluation of microcomputer software alone is very difficult and impractical, you are responsible for evaluating the safety of the final products or systems manufactured by you.
10. Please contact a Renesas Electronics sales office for details as to environmental matters such as the environmental compatibility of each Renesas Electronics product. You are responsible for carefully and sufficiently investigating applicable laws and regulations that regulate the inclusion or use of controlled substances, including without limitation, the EU RoHS Directive, and using Renesas Electronics products in compliance with all these applicable laws and regulations. Renesas Electronics disclaims any and all liability for damages or losses occurring as a result of your noncompliance with applicable laws and regulations.
11. Renesas Electronics products and technologies shall not be used for or incorporated into any products or systems whose manufacture, use, or sale is prohibited under any applicable domestic or foreign laws or regulations. You shall comply with any applicable export control laws and regulations promulgated and administered by the governments of any countries asserting jurisdiction over the parties or transactions.
12. It is the responsibility of the buyer or distributor of Renesas Electronics products, or any other party who distributes, disposes of, or otherwise sells or transfers the product to a third party, to notify such third party in advance of the contents and conditions set forth in this document.
13. This document shall not be reprinted, reproduced or duplicated in any form, in whole or in part, without prior written consent of Renesas Electronics.
14. Please contact a Renesas Electronics sales office if you have any questions regarding the information contained in this document or Renesas Electronics products.

(Note1) "Renesas Electronics" as used in this document means Renesas Electronics Corporation and also includes its directly or indirectly controlled subsidiaries.

(Note2) "Renesas Electronics product(s)" means any product developed or manufactured by or for Renesas Electronics.

(Rev.5.0-1 October 2020)

## Corporate Headquarters

TOYOSU FORESIA, 3-2-24 Toyosu,  
Koto-ku, Tokyo 135-0061, Japan  
[www.renesas.com](http://www.renesas.com)

## Trademarks

Renesas and the Renesas logo are trademarks of Renesas Electronics Corporation. All trademarks and registered trademarks are the property of their respective owners.

## Contact information

For further information on a product, technology, the most up-to-date version of a document, or your nearest sales office, please visit:  
[www.renesas.com/contact/](http://www.renesas.com/contact/).