

# TRAY CONTAINER

UNIT : mm

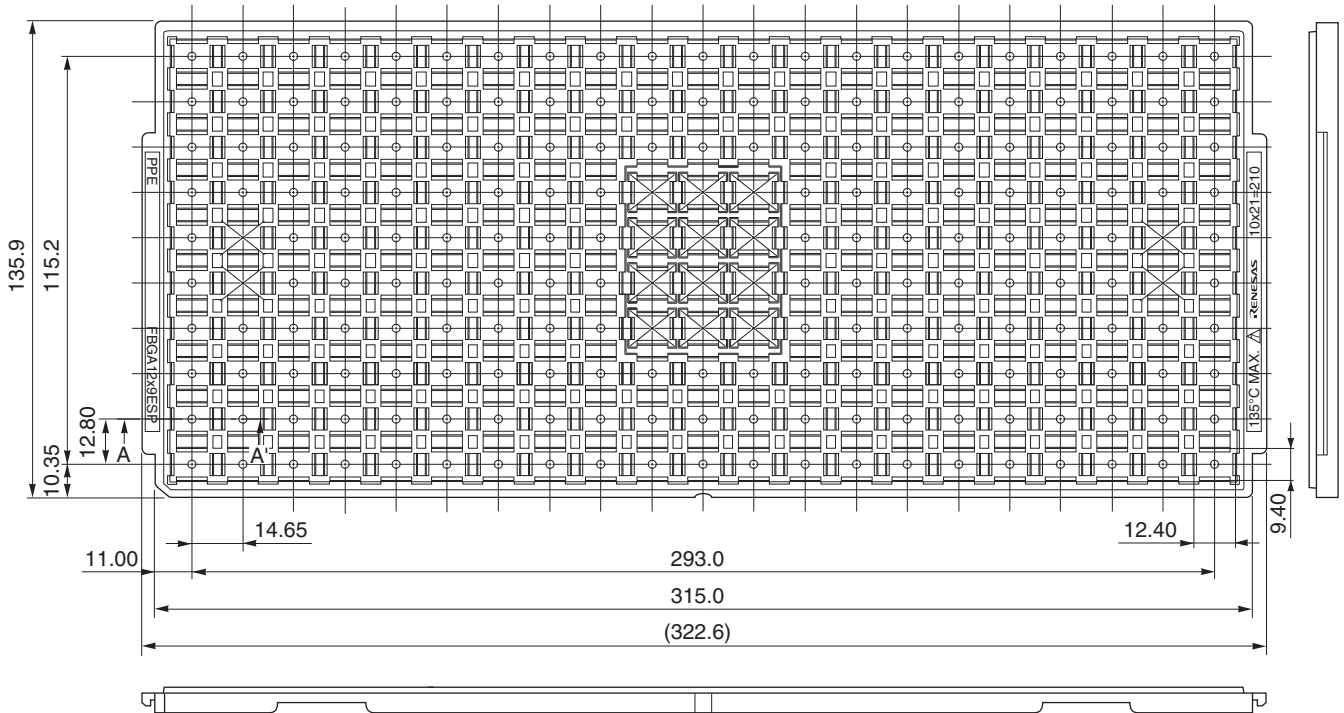

Section A – A'

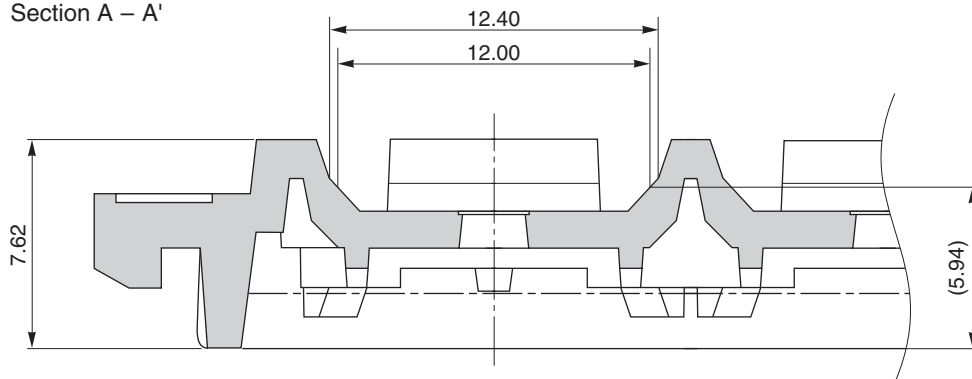

Applied Package	Quantity (pcs)
93-pin Plastic FBGA (12x9)	210 MAX.

Tray	FBGA12x9ESP
Material	Carbon PPE
Heat Proof Temp.	135°C MAX.
Surface Resistance	Less than $1 \times 10^{12} \Omega / \square$

The tolerance of tray's dimensions are based on JEDEC STANDARD.