

DA14535MOD

SmartBond TINY Bluetooth® LE Module

General Description

The DA14535MOD is a lowest-power consumption, low-cost, fully self-contained Bluetooth® Low Energy v5.3 Module that is world-wide certified and ideal for a range of applications, including fast-upgrade projects to wirelessly connect your product to a smartphone for quick-and-simple commissioning/control/alerts/data collection.

The DA14535MOD is a pin-equivalent and functional-equivalent alternative to the DA14531MOD, with both modules offering Cortex®-M0+, clocking at 16 MHz and on-die RAM, ROM, and OTP with integrated 1-Mbit Flash, 32-MHz crystal, power inductor, RF matching, and printed antenna. Both modules also have castellated pins for easy prototype soldering.

The DA14535MOD differs from the DA14531MOD in the following key features:

- Transmit Pout up to +3 dBm
- 64 kB RAM, 160 kB ROM, 12 kB OTP
- Compliance with BT5.3
- 2-wire UART support for Host-MCU based operation*

*This feature is supported by the inclusion of a secondary boot loader in Flash during factory programming. For applications where a host MCU SoC is also present, this feature permits use of the host MCU's memory to store and download DA14535MOD code for a Bluetooth LE data-pump. This feature can also remove the need for DA14535MOD factory programming during end-product production test.

SmartBond TINY™ Modules are supported by a range of applications software, including a configurable DSPPS (serial port service) and next generation Codeless software, making projects fast and easy, to the point where advanced programming skills and even knowledge of Bluetooth® is not required in many cases.

The combination of affordable price, lowest power consumption and ease of use makes the DA14535MOD an ideal product for the broad market, including lower volume, or prototyping customers.

Key Features

- Bluetooth
 - Compatible with Bluetooth® v5.3
 - ETSI EN 300 328 and EN 300 440 Class 2 (Europe), FCC CFR47 Part 15 (US) and ARIB STD-T66 (Japan)
 - Supports up to three Bluetooth® LE connections
 - Renesas registered BD address preprogrammed in OTP
- Processing and memories
 - 16 MHz 32-bit Arm® Cortex® M0+ with SWD interface
 - 128 kB onboard Flash
 - 64 kB RAM
 - 160 kB ROM
 - 12 kB OTP
- Current Consumption
 - 2.7 mA RX at VBAT = 3 V
 - 2.6 mA TX at VBAT = 3 V and 0 dBm
 - 1.7 µA at sleep with all RAM retained
- Radio
 - Programmable RF transmit power from -18 to +3 dBm
 - -92.5 dBm receiver sensitivity
- Interfaces
 - Quadrature decoder with 3 channels
 - Channel 10-bit ADC
 - 2 general purpose timers with PWM
 - 9 GPIOs
 - SPI
 - 2x UART, 1-wire UART support
 - I2C
- Power Management
 - Operating range (1.8 V-3.6 V)
 - Inrush current control
- Other
 - Real Time Clock
 - Trimmed 32 MHz Crystal
- Packaging
 - 12.5 mm x 14.5 mm x 2.8 mm package
- Module Software Development Kit
 - Configurable DSPS
 - Codeless v2.0
 - SDK6 support
- Module Software Tools
 - Flash/OTP programmer
- SUOTA support
- Battery Life Estimation
- Data Rate Monitoring
- Real-Time Power Profiling
- Production Line Testing
- Standards Conformance
 - BT SIG QDID 216526
 - Europe (CE/RED)
 - UK (UKCA)
 - US (FCC)
 - Canada (IC)
 - Japan (MIC)
 - South Korea (MSIP)
 - Taiwan (NCC)
 - Brazil (ANATEL)
 - South Africa (ICASA)
 - China (SRRC)
 - Thailand (NBTC)
 - India (WPC)
 - Australia/New Zealand (ACMA)

Applications

- Beacons
- Remote Controls
- Proximity tags
- Low Power Sensors
- Commissioning/Provisioning
- RF pipe
- Toys
- Industrial applications
- Data acquisition
- Wellness
- Infotainment
- IoT
- Robotics
- Gaming

Contents

General Description.....	1
Key Features	2
Applications	2
Contents	3
Figures	4
Tables.....	4
1. Terms and Definitions	6
2. References.....	6
3. Block Diagram.....	7
4. Pinout.....	8
5. Characteristics	10
5.1 Absolute Maximum Ratings	10
5.2 Recommended Operating Conditions	10
5.3 Device Characteristics	10
6. Mechanical Specifications	13
6.1 Mechanical Dimensions and Land Pattern	13
6.2 Marking	13
7. BOM.....	14
8. Packaging Information	15
8.1 Tape and Reel	15
8.2 Labeling	16
9. Application Information	18
9.1 Hardware Considerations	18
9.2 Software Considerations	18
10. Design Guidelines	20
10.1 Installation Location	20
10.2 Antenna Graphs.....	22
10.3 Radiation Pattern	23
11. Soldering	25
12. Moisture Sensitivity Label	26
13. Ordering Information.....	26
14. Regulatory Information	27
14.1 CE (Radio Equipment Directive 2014/53/EU (RED)) – (Europe)	28
14.2 FCC – (U.S.A.).....	28
14.2.1 List of Applicable FCC Rules	28
14.2.2 Summarize the Specific Operational Use Conditions	28
14.2.3 Limited Module Procedures	28
14.2.4 Trace Antenna Designs.....	28
14.2.5 RF Exposure Considerations	28
14.2.6 Antennas	28
14.2.7 Label and Compliance Information	28
14.2.8 Information on Test Modes and Additional Testing Requirements	29
14.2.9 Additional Testing, Part 15 Subpart B Disclaimer	29
14.3 IC (Canada)	29

14.4 UKCA (UK)	30
14.5 NCC (Taiwan)	31
14.6 MSIP (South Korea).....	31
14.7 ICASA (South Africa)	31
14.8 ANATEL (Brazil)	32
14.9 SRRC (China).....	32
14.10 MIC (Japan)	32
14.11 NBTC (Thailand).....	33
14.12 WPC (India)	34
14.13 Australia/New Zealand.....	34
14.14 WEEE Directive (2012/19/EU).....	34
15. Bluetooth SIG Qualification	35
Revision History	36

Figures

Figure 1. DA14535 SmartBond TINY™ module block diagram	7
Figure 2. Pinout diagram (top view).....	8
Figure 3. Module shield marking	13
Figure 4. Tape and reel	15
Figure 5. Reel labeling.....	16
Figure 6. EU-UK directives conformity labels	16
Figure 7. CMIIT label	16
Figure 8. ICASA (S. Africa) label	17
Figure 9. Example of connecting a sensor to the SPI bus and an MCU to RST and UART	18
Figure 10. Default boot sequence	19
Figure 11. Installation locations for optimum antenna performance	20
Figure 12. Antenna performance in proximity of copper (left), laminate (middle), and laminate under antenna (right).....	21
Figure 13. DA14535 TINY™ module evaluation board	21
Figure 14. VSWR installed in the upper left corner (position #1) of evaluation board.....	22
Figure 15. VSWR with module installed in center (position #2) of the evaluation board.....	22
Figure 16. VSWR with module installed in the upper right corner (position #3) of the evaluation board	22
Figure 17. Measurement plane definition	23
Figure 18. Radiation pattern for XY-plane, horizontal polarization.....	24
Figure 19. Radiation pattern for XY-plane, vertical polarization	24
Figure 20. Radiation pattern for XZ-plane, horizontal polarization.....	24
Figure 21. Radiation pattern for XZ-plane, vertical polarization	24
Figure 22. Radiation pattern for YZ-plane, horizontal polarization	24
Figure 23. Radiation pattern for YZ-plane, vertical polarization	24
Figure 24. Recommended reflow profile for lead free solder	25

Tables

Table 1: Pin description	8
Table 2: Absolute maximum ratings	10
Table 3: Recommended operating conditions	10
Table 4: DC characteristics.....	10
Table 5: XTAL32M - Recommended operating conditions.....	11
Table 6: Digital I/O - Recommended operating conditions.....	11
Table 7: Digital I/O - DC characteristics	12

Table 8: Radio - AC characteristics	12
Table 9: Bill of materials	14
Table 10: Reel specifications.....	15
Table 11: Antenna efficiency vs TINY™ module positions.....	20
Table 12: Reflow profile specification	25
Table 13: MSL level vs floor lifetime	26
Table 14: Ordering information (samples)	26
Table 15: Ordering information (production).....	26
Table 16: Standards conformance	27

1. Terms and Definitions

ADC	Analog-to-Digital Converter
DIO	Digital Input-Output
I-PD	Input-Pulled Down
I-PU	Input-Pulled Up
GND	Ground
MSL	Moisture Sensitivity Level
NTC	Negative Temperature Coefficient
PCB	Printed Circuit Board
PWR	Power
RDS	Reduced Driving Strength
VSWR	Voltage Standing Wave Ratio

2. References

- [1] DA14535, [Datasheet](#), Renesas Electronics.
- [2] [UM-B-119: DA14585/DA14531 SW Platform Reference Manual](#), Renesas Electronics.
- [3] [UM-B-171: Renesas SmartBoot Bootloader Reference Manual](#), Renesas Electronics.

Note 1 References are for the latest published version, unless otherwise indicated.

3. Block Diagram

The DA14535 SmartBond TINY™ Module is based on the Renesas DA14535 SoC configured in buck mode. With an integrated 1 Mbit NOR Flash, 32 MHz XTAL and a printed antenna, the module enables a faster time to market at reduced development costs.

The module, as seen in [Figure 1](#), consists of:

- 1 Mbit SPI Flash
- 32 MHz XTAL
- 2 decoupling capacitors
- A power inductor
- A CLC filter and matching components for the printed antenna.

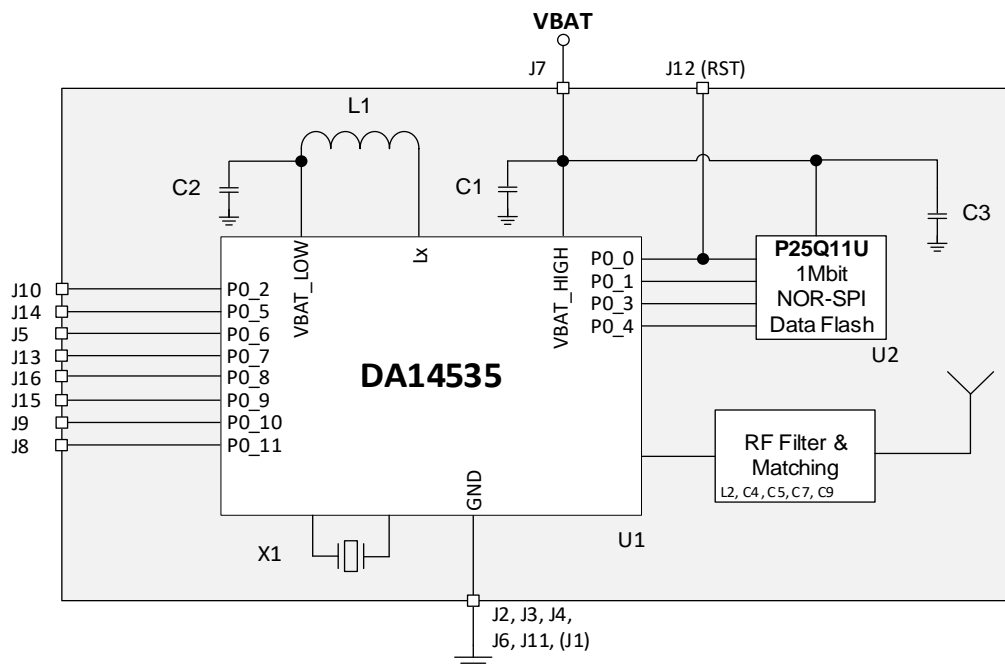

Figure 1. DA14535 SmartBond TINY™ module block diagram

4. Pinout

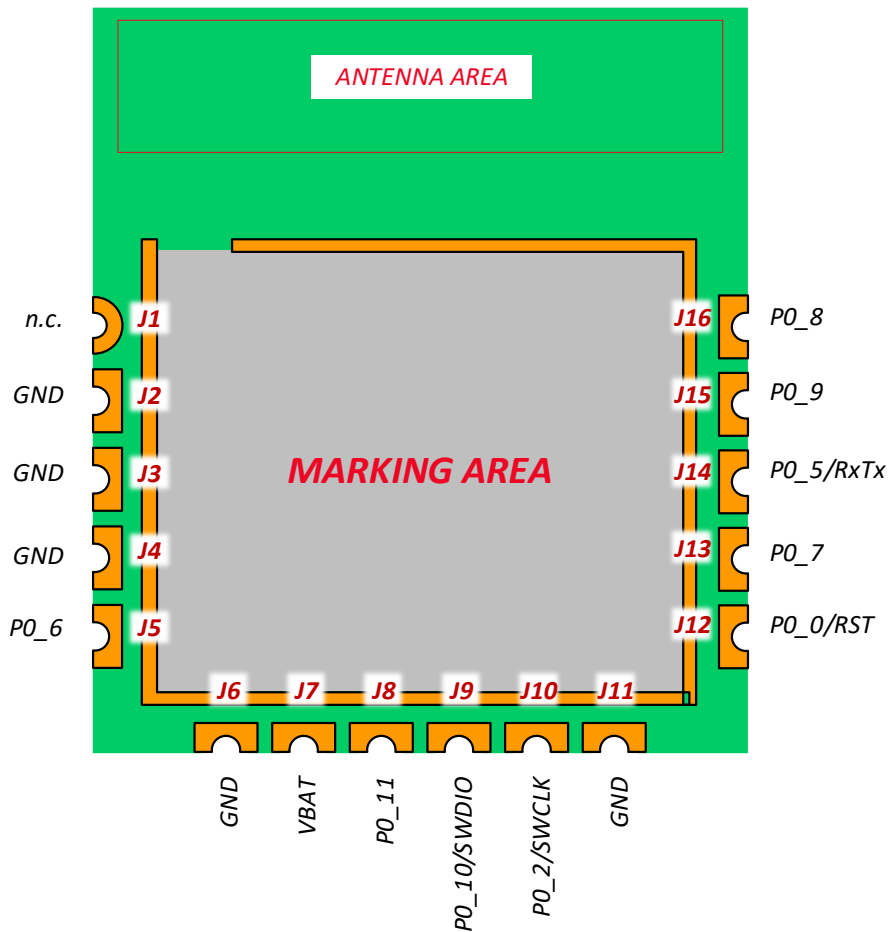

Figure 2. Pinout diagram (top view)

Note that J1 has no internal connection. J1 should be connected to the ground.

Table 1: Pin description

Pin #	Pin Name	Type	Reset State	Description
J1	n.c			Not internally connected. Recommended to be connected to ground externally.
J2	GND	GND		Ground.
J3	GND	GND		Ground.
J4	GND	GND		Ground.
J5	P0_6	DIO (Type A) Note 1	I-PD	INPUT/OUTPUT with selectable pull-up/down resistors. Pull-down enabled during and after reset. General purpose I/O port bit or alternate function nodes. Contains a state retention mechanism during power down.
J6	GND	GND		Ground.
J7	VBAT	PWR		POWER. Battery connection. IO supply
J8	P0_11	DIO (Type A)	I-PD	INPUT/OUTPUT with selectable pull-up/down resistors. Pull-down enabled during and after reset. General purpose I/O port bit or alternate function nodes. Contains a state retention mechanism during power down.

Pin #	Pin Name	Type	Reset State	Description
J9	P0_10	DIO (Type A)	I-PD	INPUT/OUTPUT with selectable pull-up/down resistors. Pull-down enabled during and after reset. General purpose I/O port bit or alternate function nodes. Contains a state retention mechanism during power down.
	SWDIO			INPUT/OUTPUT. SWI Data input/output. Bidirectional data and control communication (by default).
J10	P0_2	DIO (Type B)	I-PD	INPUT/OUTPUT with selectable pull-up/down resistors. Pull-down enabled during and after reset. General purpose I/O port bit or alternate function nodes. Contains a state retention mechanism during power-down.
	SWCLK			INPUT SWI clock signal (by default).
J11	GND	GND		Ground.
J12	P0_0	DIO (Type B) Note 2	I-PD	INPUT/OUTPUT with selectable pull-up/down resistors. Pull-down enabled during and after reset. General purpose I/O port bit or alternate function nodes. Contains a state retention mechanism during power-down.
	RST			RST active high hardware reset (default).
J13	P0_7	DIO (Type A)	I-PD	INPUT/OUTPUT with selectable pull-up/down resistors. Pull-down enabled during and after reset. General purpose I/O port bit or alternate function nodes. Contains a state retention mechanism during power down.
J14	P0_5	DIO (Type B)	I-PD	INPUT/OUTPUT with selectable pull-up/down resistors. Pull-down enabled during and after reset. General purpose I/O port bit or alternate function nodes. Contains a state retention mechanism during power down.
J15	P0_9	DIO (Type A)	I-PD	INPUT/OUTPUT with selectable pull-up/down resistors. Pull-down enabled during and after reset. General purpose I/O port bit or alternate function nodes. Contains a state retention mechanism during power down.
J16	P0_8	DIO (Type A)	I-PD	INPUT/OUTPUT with selectable pull-up/down resistors. Pull-down enabled during and after reset. General purpose I/O port bit or alternate function nodes. Contains a state retention mechanism during power down.

Note 1 There are two types of pads, namely Type A and Type B. Type A is a normal IO pad with a Schmitt trigger on input while Type B has an extra RC Filter with a cutoff frequency of 100 kHz.

Note 2 This pin is also used for communication to the onboard SPI Flash.

5. Characteristics

All MIN/MAX specification limits are guaranteed by design, production testing, and/or statistical characterization. Typical values are based on characterization results at default measurement conditions and are informative only.

Default measurement conditions (unless otherwise specified): $V_{BAT} = 3.0\text{ V}$, $T_A = 25\text{ °C}$. All radio measurements are done with standard RF measurement equipment.

5.1 Absolute Maximum Ratings

Stresses beyond those listed under Absolute Maximum Ratings may cause permanent damage to the device. These are stress ratings only, so functional operation of the device at these or any other conditions beyond those indicated in the operational sections of the specification are not implied. Exposure to Absolute Maximum Rating conditions for extended periods may affect device reliability.

Table 2: Absolute maximum ratings

Parameter	Description	Conditions	Min	Max	Unit
V_{BAT_LIM}	Limiting battery supply voltage		-0.2	3.6	V

5.2 Recommended Operating Conditions

Table 3: Recommended operating conditions

Parameter	Description	Conditions	Min	Typ	Max	Unit
V_{BAT}	Battery supply voltage	Voltage range within FLASH programming is possible	1.65		3.6	V
V_{BAT_NOM}	Nominal battery supply voltage			3		V
V_{PIN}	Voltage on a pin		-0.2		3.6	V
T_A	Ambient operating temperature		-40	25	85	°C

5.3 Device Characteristics

Table 4: DC characteristics

Parameter	Description	Conditions	Min	Typ	Max	Unit
I_{BAT_ACTIVE}	Battery supply current	CPU running CoreMark from RAM at 16 MHz.		0.47		mA
$I_{BAT_BLE_ADV_100ms}$	Average battery supply current	System in Advertising state (3 channels) every 100 ms and extended sleep with all RAM retained. TX output power at 3 dBm. FLASH is off.		79		μA
$I_{BAT_BLE_CONN_30ms}$	Average battery supply current	System in a connection state with 30 ms connection interval and extended sleep with all RAM retained. TX output power at 3 dBm. FLASH is off.		105		μA
I_{BAT_FLASH}	Battery supply current	CPU fetching code from serial FLASH. RF is off.		0.6		mA
I_{BAT_HIBERN}	Battery supply current	System shut down (Hibernation or shipping mode). FLASH is off.		0.9		μA
I_{BAT_IDLE}	Battery supply current	CPU in Wait for Interrupt Mode. FLASH is off.		0.22		mA

Parameter	Description	Conditions	Min	Typ	Max	Unit
I _{BAT_SLP_32KB}	Battery supply current	System in extended sleep mode and 32 kB RAM retained.		1.4		μA
I _{BAT_SLP_64KB}	Battery supply current	System in extended sleep mode and all RAM retained.		1.7		μA
I _{BAT_RF_RX}	Battery supply current	Continuous RX; FLASH in sleep mode; DCDC converter is on		2.7		mA
I _{BAT_RF_TX_+3dBm}	Battery supply current	Continuous TX; FLASH in sleep mode; DCDC converter is on; Output power setting = 12. Note 1		3.2		mA
I _{BAT_RF_TX_0dBm}	Battery supply current	Continuous TX; FLASH in sleep mode; DCDC converter is on; Output power setting = 8. Note 1		2.6		mA
I _{BAT_RF_TX_-3dBm}	Battery supply current	Continuous TX; FLASH in sleep mode; DCDC converter is on; Output power setting = 6. Note 1		2.3		mA
I _{BAT_RF_TX_-6dBm}	Battery supply current	Continuous TX; FLASH in sleep mode; DCDC converter is on; Output power setting = 4. Note 1		2		mA
I _{BAT_RF_TX_-18dBm}	Battery supply current	Continuous TX; FLASH in sleep mode; DCDC converter is on; Output power setting = 1. Note 1		1.3		mA

Note 1 The nominal output power level might slightly deviate from the actual value.

Table 5: XTAL32M - Recommended operating conditions

Parameter	Description	Conditions	Min	Typ	Max	Unit
f _{XTAL(32M)}	Crystal oscillator frequency			32		MHz
Δf _{XTAL(32M)}	Crystal frequency tolerance	After optional trimming; including aging and temperature drift Note 1	-20		20	ppm

Note 1 Using the internal varicaps a wide range of crystals can be trimmed to the required tolerance.

Table 6: Digital I/O - Recommended operating conditions

Parameter	Description	Conditions	Min	Typ	Max	Unit
V _{IH}	HIGH level input voltage	V _{DD} = 0.9 V	0.7*V _{DD}			V

Parameter	Description	Conditions	Min	Typ	Max	Unit
V _{IL}	LOW level input voltage	V _{DD} = 0.9 V			0.3*V _{DD}	V

Table 7: Digital I/O - DC characteristics

Parameter	Description	Conditions	Min	Typ	Max	Unit
I _{IH}	HIGH level input current	V _I =V _{BAT} = 3.0 V	-10		10	μA
I _{IL}	LOW level input current	V _I =V _{SS} = 0 V	-10		10	μA
I _{IH_PD}	HIGH level input current	V _I =V _{BAT} = 3.0 V	60		180	μA
I _{IL_PU}	LOW level input current	V _I =V _{SS} = 0 V, V _{BAT} = 3.0 V	-180		-60	μA
V _{OH}	HIGH level output voltage	I _O = 3.5 mA, V _{BAT} = 1.7 V	0.8*V _{BAT}			V
V _{OL}	LOW level output voltage	I _O = 3.5 mA, V _{BAT} = 1.7 V			0.2*V _{BAT}	V
V _{OH_LOWDRV}	HIGH level output voltage	I _O = 0.3 mA, V _{BAT} = 1.7 V	0.8*V _{BAT}			V
V _{OL_LOWDRV}	LOW level output voltage	I _O = 0.3 mA, V _{BAT} = 1.7 V			0.2*V _{BAT}	V

Table 8: Radio - AC characteristics

Parameter	Description	Conditions	Min	Typ	Max	Unit
P _{SENS_CLEAN}	Sensitivity level	Dirty Transmitter disabled; DC-DC converter disabled; PER = 30.8%. Note 1		-92.5		dBm
P _{SENS_EPKT}	Sensitivity level	Extended packet size (255 octets)		-89.5		dBm

Note 1 Measured according to Bluetooth® Low Energy Test Specification.

6. Mechanical Specifications

6.1 Mechanical Dimensions and Land Pattern

The module's dimensions are accessible from the Renesas website - [16-Module](#).

6.2 Marking

The module's shield marking is shown in [Figure 3](#).

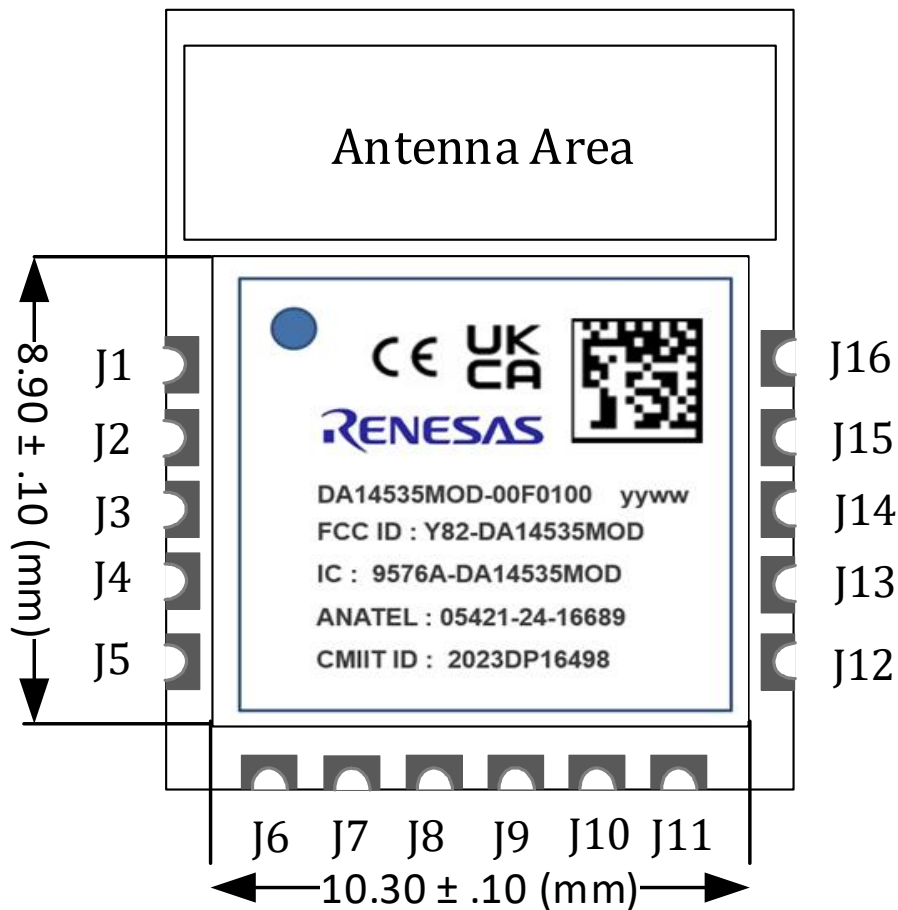

Figure 3. Module shield marking

Marking Legend:

DA14535MOD-00F0100 yyww

yy: production year

ww: production week

All dimensions in mm. Tolerance 0.4 mm.

7. BOM

Table 9: Bill of materials

#	Designator	Type	Value	Description	Manufacturer	MPN
1	U1	IC	DA14535-00000FX2	Bluetooth Low Energy DA14535 FCGQFN24	Renesas	DA14535-00000FX2
2	U2	NOR Flash	P25Q11U-UXH-IR	FLASH 1MBIT SPI 104 MHZ 8USON 3x2x0.55 mm	Puya Semiconductor	P25Q11U-UXH-IR
3	X1	Crystal Oscillator	32 MHz 6 pF 10 ppm	SMD 32 MHz, 6 pF, 10 ppm	Tai-Saw	TZ3375C
4	L1	Inductor	2.2 uH	FIXED IND 2.2 μH 20% 1.5 A 160 mΩ	Taiyo Yuden	MAKK2016T2R2M
5	L2	Inductor	2.8 nH	INDUCTOR 2.8 nH ±0.1 nH 500 mA 0201	Murata	LQP03TN2N8B02D
6	C1	Capacitor	2.2 μF	CAP CER 2.2 μF 25 V 20% X5R 0402	Murata	GRM155R61E225ME15D
7	C2	Capacitor	10 μF	CAP CER 10 μF 6V3 20% X5R 0402	Murata	GRM155R60J106ME15D
8	C3	Capacitor	1 μF	CAP CER 1 μF 6V3 20% X7R 0402	Murata	GRM155R70J105MA12D
9	C4	Capacitor	1.6 pF	CAP CER 1p6 50 V 0.25 pF NP0 0201	Murata	GRM0335C1H1R6CA01D
10	C5	Capacitor	1.8 pF	CAP CER 1p8 50 V 0.25 pF NP0 0201	Murata	GRM0335C1H1R8CA01D
11	C7	Capacitor	0.8 pF	CAP CER 0p8 50 V ±0.1 pF NP0 0201	Murata	GRM0335C1HR80BA01
12	C9	Capacitor	10 pF	CAP CER 10PF 50 V ±5% NP0 0201	Murata	GRM0335C1H100JA01J

8. Packaging Information

8.1 Tape and Reel

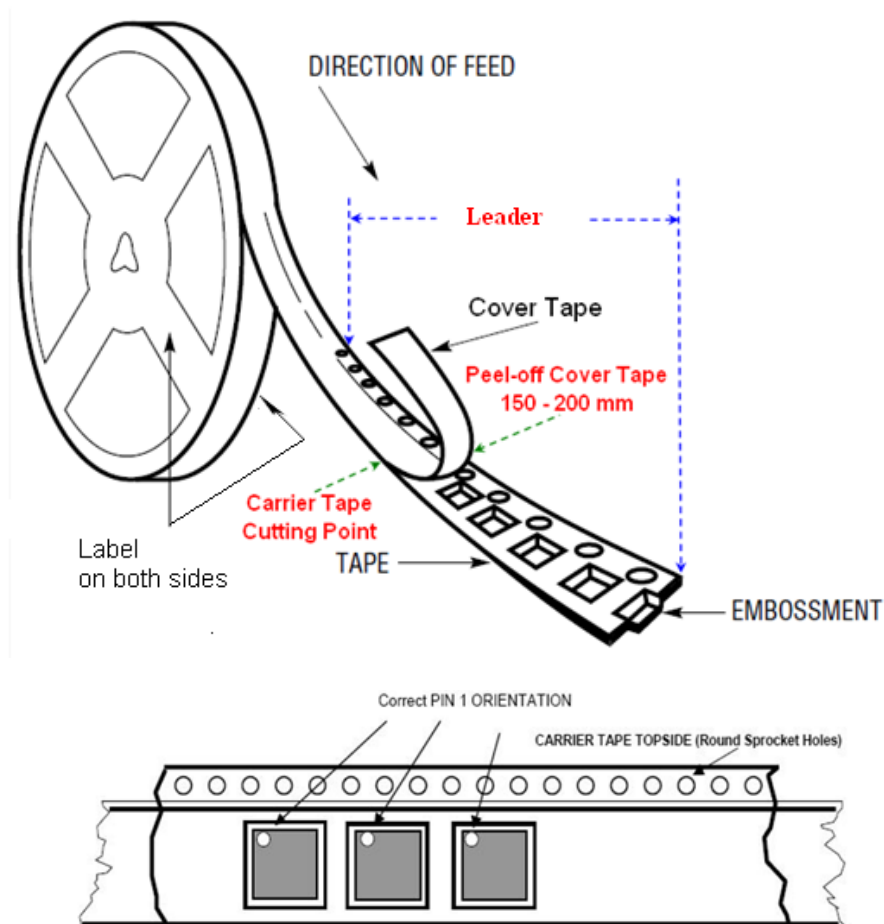

Figure 4. Tape and reel

The reel specifications are shown in [Table 10](#).

Table 10: Reel specifications

Parameter	Value
Diameter	13 inches
Reel tape width	24 mm
Tape material	Antistatic
Qty/Reel	100/1000 pcs
Leader	400 mm + 10%
Trailer	160 mm + 10%

8.2 Labeling

Figure 5 presents the label found on a typical reel.



Figure 5. Reel labeling

The directives labels show information regarding directives conformity as in Figure 6, Figure 7, and Figure 8.

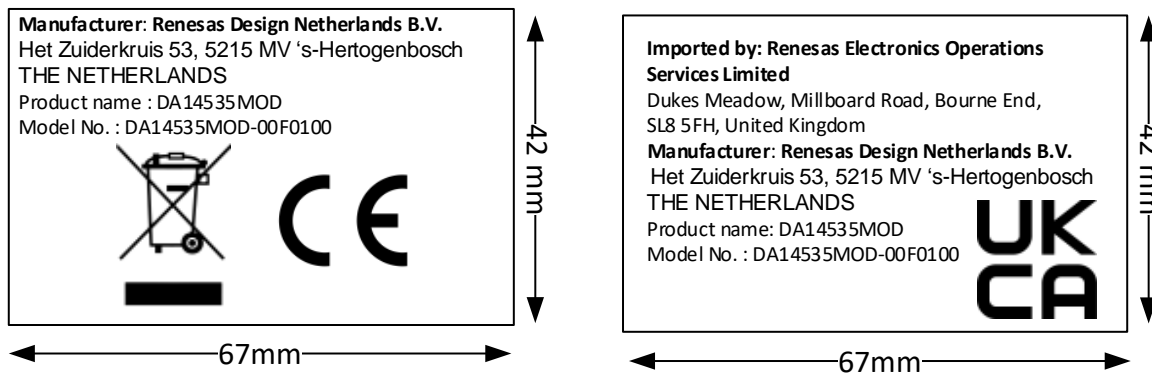

Figure 6. EU-UK directives conformity labels



Figure 7. CMIIT label



Figure 8. ICASA (S. Africa) label

9. Application Information

9.1 Hardware Considerations

There are some special considerations for the use of the TINY™ module, namely:

- The RST signal is shared with the MOSI input of the NOR Flash. For this reason, RST must not be driven to GND. When the onboard Flash is in use, the reset functionality is not available.
- The SPI Bus of DA14535 SoC is used for communication with the NOR Flash at boot time. Three of the four signals are not driven to external module pins. For this reason, a sensor that utilizes the SPI bus must be assigned (by software) to the module pins to communicate with after the boot is completed and when NOR Flash is no longer in use. An example is given in [Figure 9](#).

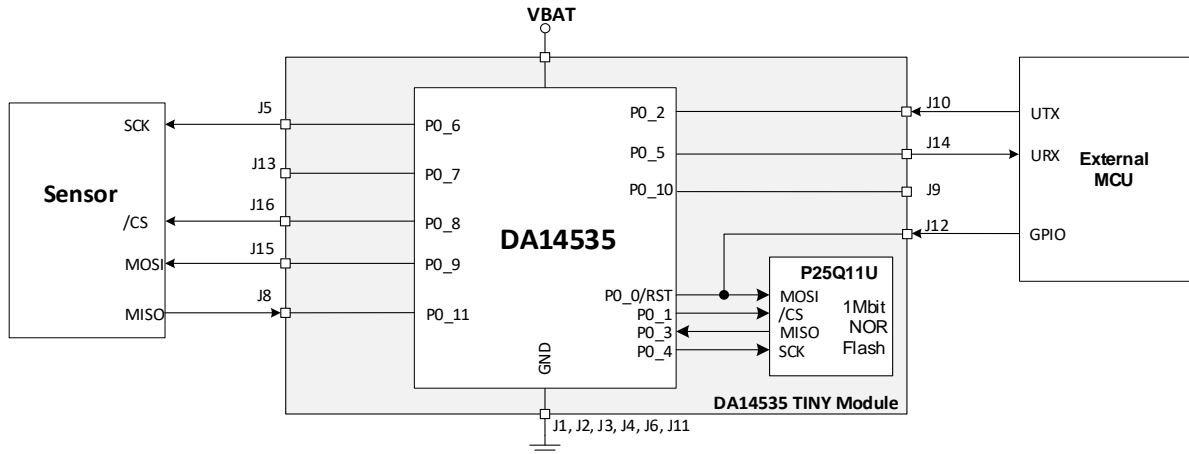

Figure 9. Example of connecting a sensor to the SPI bus and an MCU to RST and UART

Note that the P0_0/RST pin (J12) should not be driven while the TINY™ module boots from its internal SPI Flash.

9.2 Software Considerations

The DA14535 SmartBond TINY™ Module comes with the SmartBoot bootloader preloaded by default in the intergraded SPI NOR Flash. The SmartBoot bootloader executes after the primary bootloader and determines which application code needs to be loaded into RAM based on a the SmartBoot header and, optionally, on pin state or the magic word address. For more information about SmartBoot, see Ref. [\[3\]](#).

The default boot sequence is shown in [Figure 10](#).

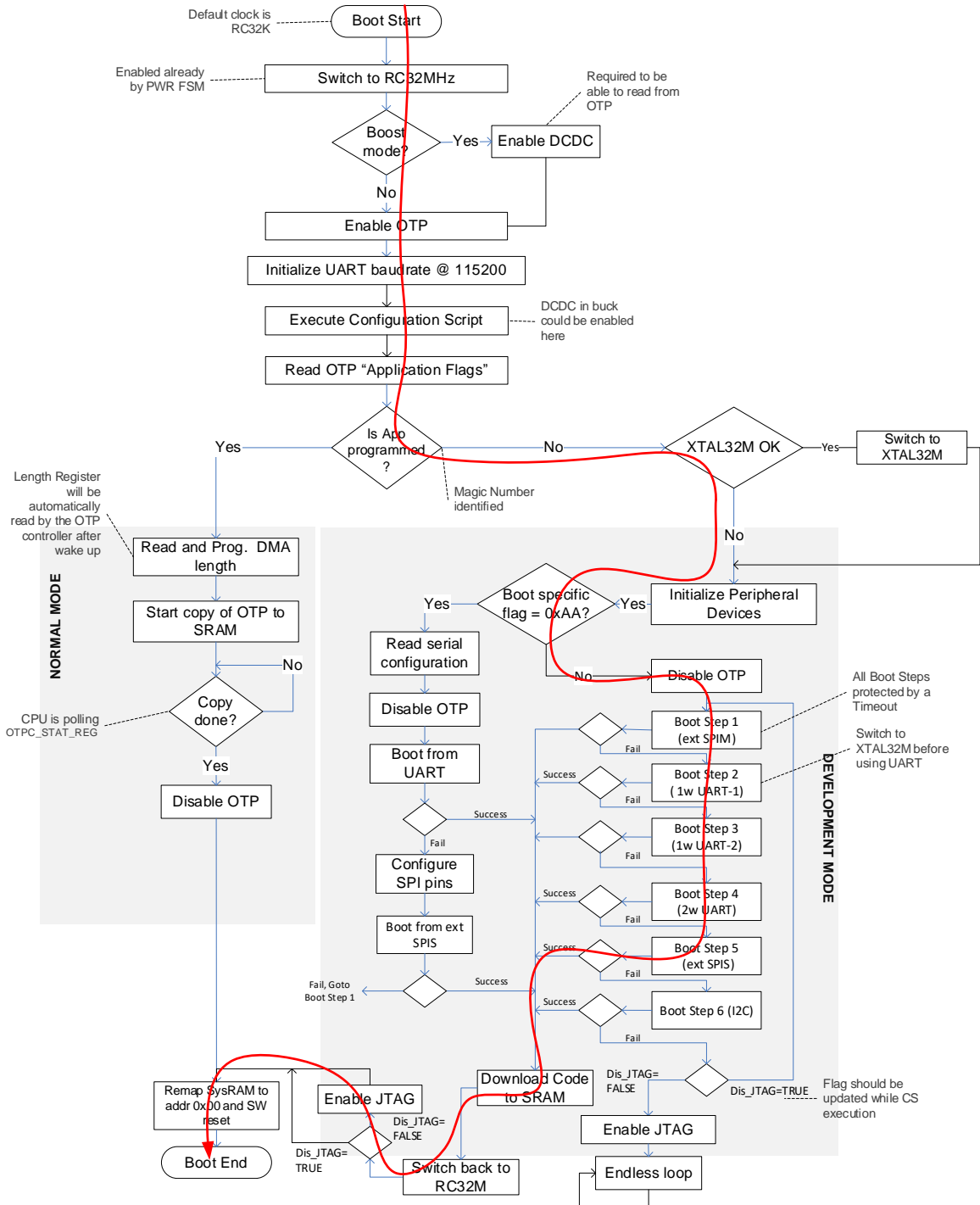

Figure 10. Default boot sequence

10. Design Guidelines

The DA14535 SmartBond TINY™ Module comes with an integrated PCB trace antenna. The antenna area is 12x4 mm. The antenna's Voltage Standing Wave Ratio (VSWR) and efficiency depend on the installation location.

The radiation performance of the PCB trace antenna depends on the host PCB layout. The maximum antenna gain is -0.5 dBi when installed on a 50x50 mm reference board, as shown in Figure 22. The radiation pattern is omnidirectional. The RF front end is optimized to achieve the maximum possible efficiency for various installation positions of the module on a host PCB. To obtain a similar performance, follow the guidelines described in the following sections.

10.1 Installation Location

For optimum performance, install the module at the edge of a host PCB with the antenna edge facing out. The module can be located on either of the outer corners or the middle of the host PCB with equivalent performance.

The antenna should have 4 mm free space in all directions. Copper or laminate in the proximity of the PCB trace antenna will affect the efficiency of the antenna. Laminate or copper under the antenna should be avoided as it severely affects the performance of the antenna. The antenna keep-out area can be seen in Figure 12.

Metals close to the antenna will degrade the antenna's performance. The amount of degradation depends on the host system's characteristics.

Table 11 summarizes the antenna efficiency at different installation locations on a host PCB as shown in Figure 11.

Table 11: Antenna efficiency vs TINY™ module positions

Freq [MHz]	Position # 1 (Left)		Position # 2 (Middle)		Position # 3 (Right)	
	Antenna efficiency [%]	Antenna efficiency [dB]	Antenna efficiency [%]	Antenna efficiency [dB]	Antenna efficiency [%]	Antenna efficiency [dB]
2405	52	-2,8	40	-4,0	40	-4,0
2440	46	-3,4	34	-4,7	41	-3,9
2480	50	-3,0	40	-4,0	52	-2,8

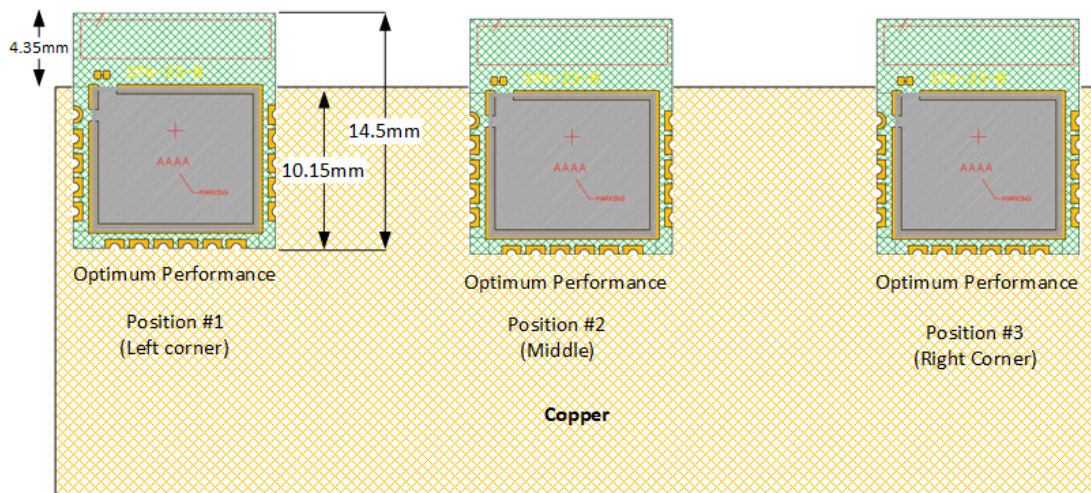

Figure 11. Installation locations for optimum antenna performance

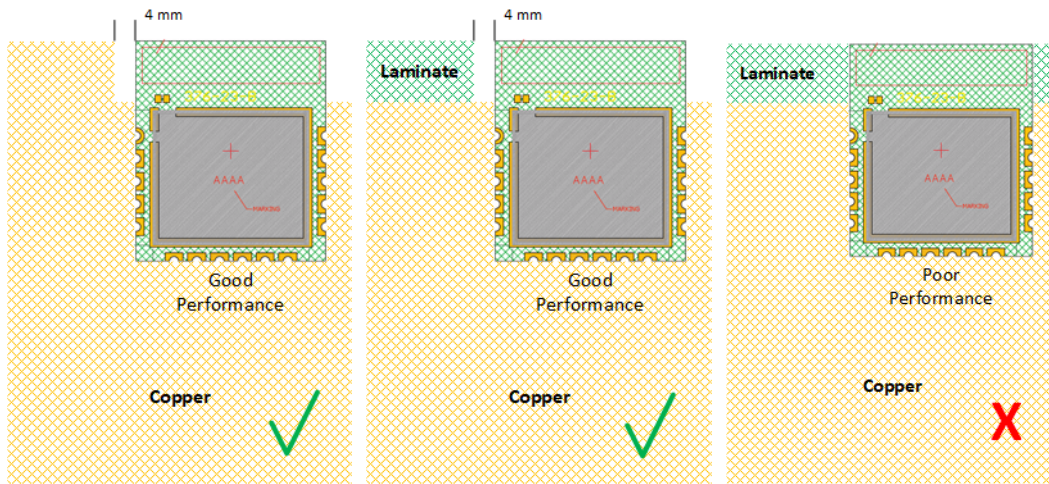

Figure 12. Antenna performance in proximity of copper (left), laminate (middle), and laminate under antenna (right) The actual TINY™ module evaluation board layout that has been used to conduct measurements is shown in Figure 13.

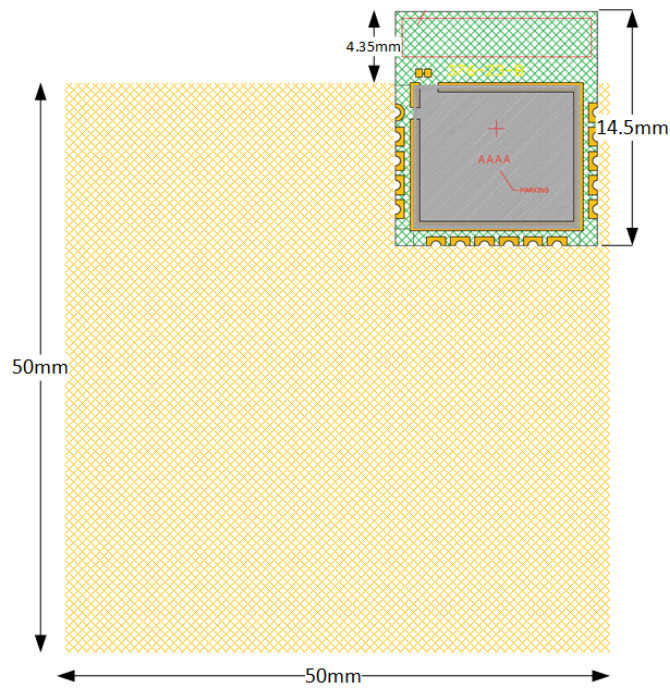

Figure 13. DA14535 TINY™ module evaluation board

10.2 Antenna Graphs

The antenna VSWR measurements for the three installation positions are shown in the following figures.

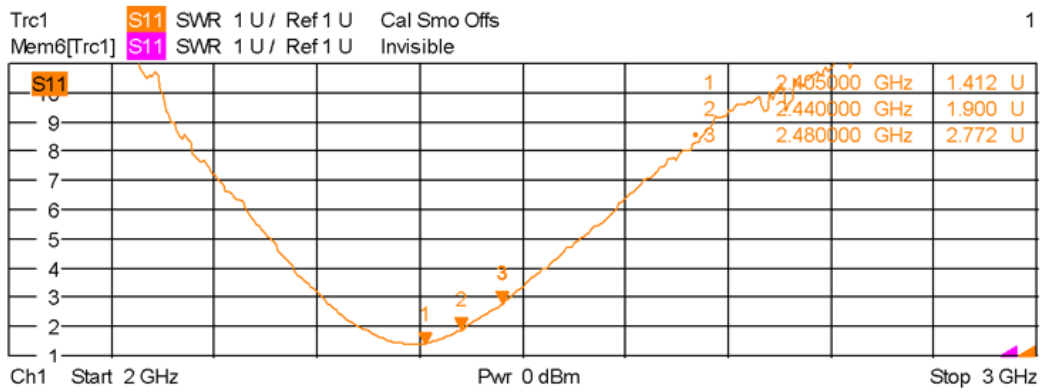

Figure 14. VSWR installed in the upper left corner (position #1) of evaluation board

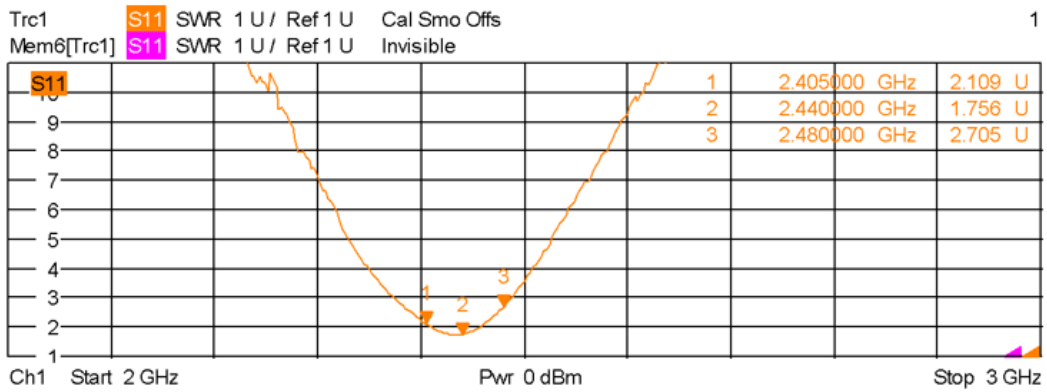

Figure 15. VSWR with module installed in center (position #2) of the evaluation board

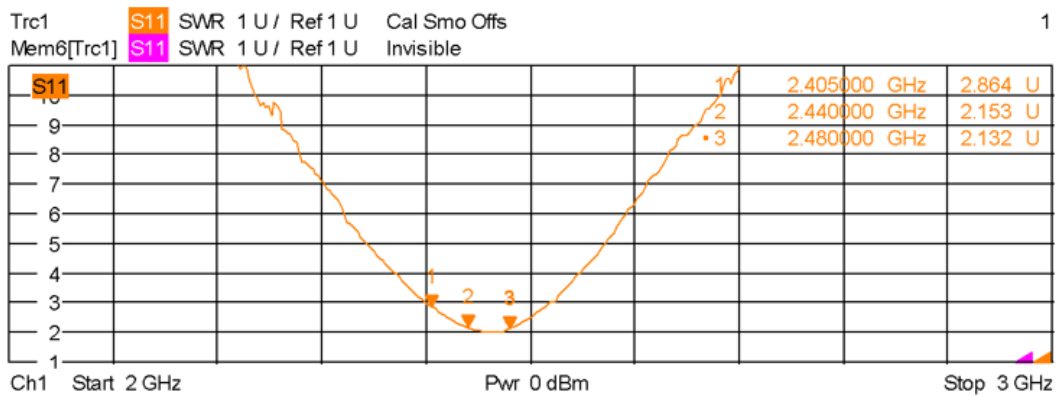

Figure 16. VSWR with module installed in the upper right corner (position #3) of the evaluation board

10.3 Radiation Pattern

The antenna radiation pattern measurements are carried out in an anechoic chamber. Radiation patterns are presented for three measurement planes: XY-, XZ-, and YZ- planes with horizontal and vertical polarization of the receiving antenna.

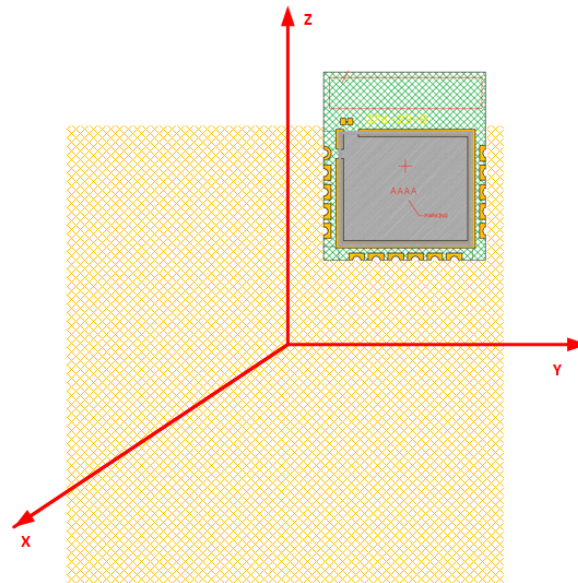

Figure 17. Measurement plane definition

Measurements are carried out for the module installed in the upper-right corner on the reference board with no laminate below the antenna trace.

Radiation Pattern for Antenna Trace

Horizontal polarization

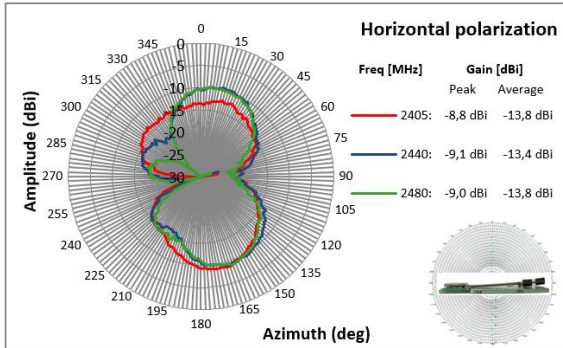

Figure 18. Radiation pattern for XY-plane, horizontal polarization

Vertical polarization

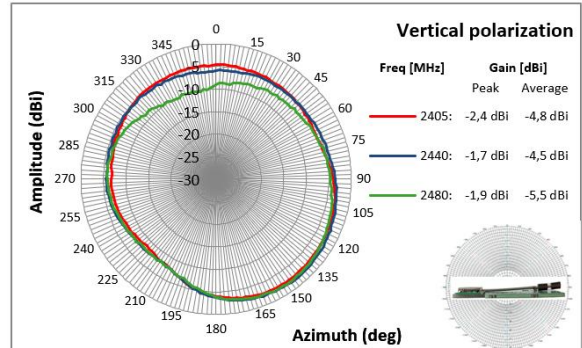

Figure 19. Radiation pattern for XY-plane, vertical polarization

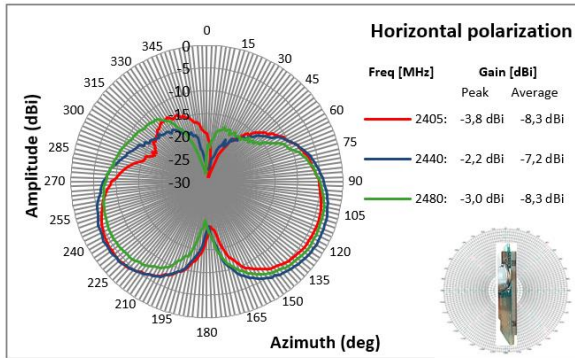

Figure 20. Radiation pattern for XZ-plane, horizontal polarization

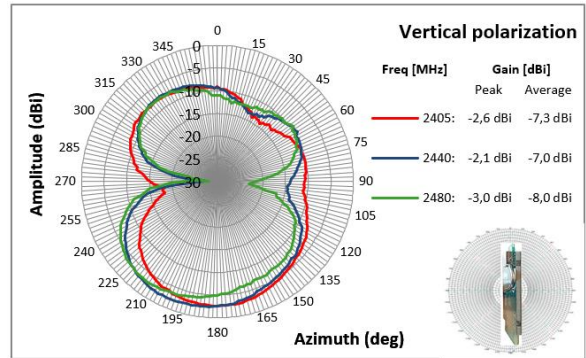

Figure 21. Radiation pattern for XZ-plane, vertical polarization

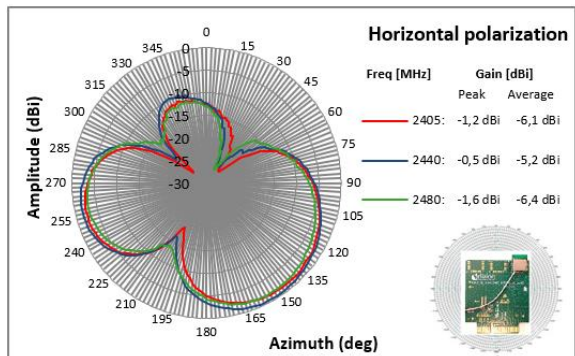

Figure 22. Radiation pattern for YZ-plane, horizontal polarization

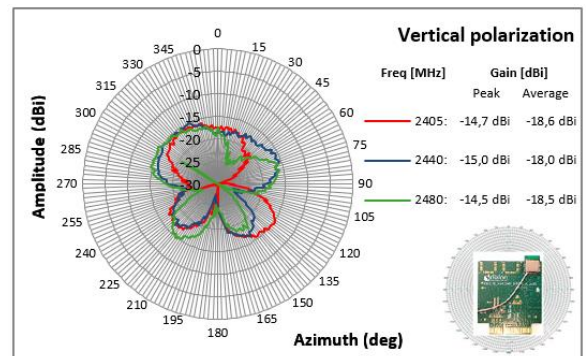

Figure 23. Radiation pattern for YZ-plane, vertical polarization

11. Soldering

The successful reflow soldering of the DA14535 TINY™ Module on a PCB depends on several parameters such as the thickness of the stencil, the pads solder paste aperture, the solder paste characteristics, the reflow soldering profile, size of the PCB, and so on.

The volume of solder paste applied to the board is mainly determined by the aperture size and stencil thickness. An initial solder paste aperture for the pads is provided on the solder paste layer of the PCB footprint. This aperture is modified by the assembly process experts according to stencil thickness, solder paste, and available assembly equipment.

The solder profile depends on the solder paste type used. For example, the soldering profile of a lead-free solder paste, Sn3Ag0.5Cu with no clean Flux (ROLO) and Solder Powder Type 4, is shown in [Figure 24](#).

No clean flux is recommended because washing must not be applied after assembly to avoid moisture being trapped under the shield.

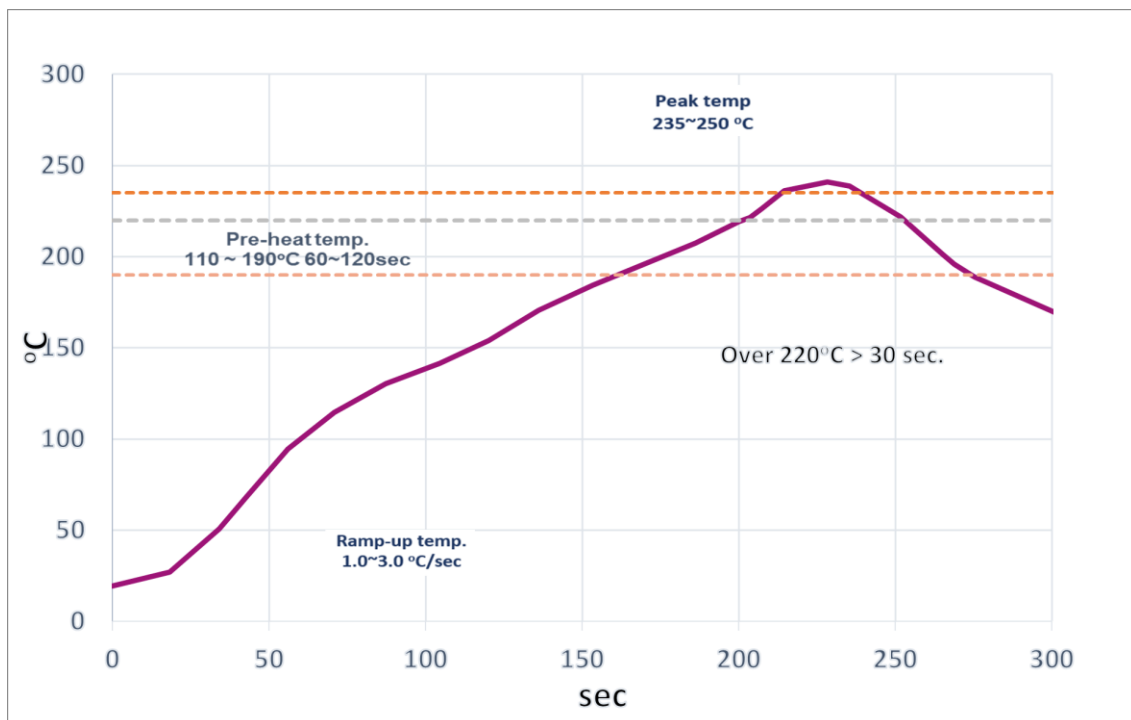

Figure 24. Recommended reflow profile for lead free solder

Table 12: Reflow profile specification

Statistic Name	Low Limit	High Limit	Units
Slope1 (Target = 2.0) Between 30.0 and 70.0	1	3	Degrees/Second
Slope2 (Target = 2.0) Between 70.0 and 150.0	1	3	Degrees/Second
Slope3 (Target = -2.8) Between 220.0 and 150.0	-5	-0.5	Degrees/Second
Preheat time 110-190 °C	60	120	Seconds
Time above reflow at 220 °C	30	65	Seconds
Peak temperature	235	250	Degrees Celsius
Total time above at 235 °C	10	30	Second

Solderability reflow check of five cycles was performed, applying the procedures mentioned in the JESD-A113E standard.

12. Moisture Sensitivity Label

The MSL is an indicator for the maximum allowable time period (floor lifetime) in which a moisture-sensitive plastic device, when removed from the dry bag, can be exposed to an environment with a maximum temperature of 30 °C and a maximum relative humidity of 60% RH before the solder reflow process.

The DA14535 TINY Module is qualified for MSL 3.

Table 13: MSL level vs floor lifetime

MSL Level	Floor Lifetime
MSL 4	72 hours
MSL 3	168 hours
MSL 2A	4 weeks
MSL 2	1 year
MSL 1	Unlimited at 30 °C/85%RH

13. Ordering Information

The ordering number consists of the part number followed by a suffix that indicates the packing method. For details and availability, consult your Renesas [local sales representative](#).

Table 14: Ordering information (samples)

Part Number	Size (mm)	Shipment Form	Pack Quantity	MOQ
DA14535MOD-00F0100C	12.5 x 14.5 x 2.8	Reel	100	3

Table 15: Ordering information (production)

Part Number	Size (mm)	Shipment Form	Pack Quantity	MOQ
DA14535MOD-00F01002	12.5 x 14.5 x 2.8	Reel	1000	1

14. Regulatory Information

This section outlines the regulatory information for the DA14535 SmartBond TINY™ Module. The module is certified for the global market. This facilitates the market entry of the end product. Note that the end product would need to apply for the end product certification, however, the module certification listed below will facilitate that procedure.

When the user sends the end product to those markets, the end product may need to follow additional requirements according to the specific market regulation.

For example, some markets have additional testing and/or certification like Korea EMC, South Africa SABS EMC and some have the requirement to put on the end product label a modular approval ID or mark that consists of an approved Bluetooth® Low Energy modular ID on host label directly, like Japan, Taiwan, Brazil.

A list of the Conformance Standards that the DA14535 SmartBond TINY™ Module meets is shown in [Table 16](#).

Table 16: Standards conformance

Area	Item	Service	Standard	Certificate ID
Global	Safety for module	CB	IEC 62368-1:2018 EN IEC 62368-1:2020+A11:2020, BS EN IEC 62368-1:2020+A11:2020	SG ITS-33804 Note 1
Europe	Wireless	RED	EN 300 328 v2.2.2 EN 62479:2010	SE-RED-2301331 Ed.1
	Safety for module		EN IEC 62368-1: 2020+A11: 2020	
	EMC		EN 301 489-1 v2.2.3 EN 301 489-17 v3.2.4	
UK	Wireless	UKCA	EN 300 328 v2.2.2 EN 62479:2010	UK-RER-442
	Safety for module		BS EN IEC 62368-1: 2020+A11: 2020	
	EMC		EN 301 489-1 V2.2.3 EN 301 489-17 V3.2.4	
US/CA	Wireless	FCC ID	47 CFR PART 15 Subpart C: 2021 section 15.247	Y82-DA14535MOD
		IC ID	RSS-247 Issue 2: February 2017 RSS-Gen Issue 5: April 2018+A1: March 2019+A2: February 2021	9576A-DA14535MOD
Japan	Wireless	MIC	JRL	012-230026
Taiwan	Wireless	NCC	LP0002	CCAG23Y10080T7
South Korea	Wireless	MSIP	방송통신표준 KS X 3123 "무선 설비 적합성 평가 시험 방법" KN 301 489	R-R-8DL-DA14535MOD
South Africa	Wireless	ICASA	Based on RED	TA-2023/2817
Brazil	Wireless	Anatel	ATO No.14448/2017 Resolution No.680	05421-14-16689
China	Wireless	SRRC	信部无【2002】353	2023DP16498
Thailand	Wireless	NBTC	NBTC TS 1035-2562	SD03391-23
India	Wireless	WPC	Based on RED	ETA-SD-20231110128
Australia/ New Zealand	Wireless	ACMA	Based on RED	-

Note 1 Include national differences of the US/Canada/Japan/China/Korea/Europe/Australia/South Africa/Taiwan/Brazil/Thailand.

14.1 CE (Radio Equipment Directive 2014/53/EU (RED)) – (Europe)

Model no. DA14535MOD-00F0100

The DA14535 SmartBond TINY™ Module is a Radio Equipment Directive (RED) assessed radio that is CE marked. The module has been manufactured and tested with the intention of being a subassembly to a final product. The module has been tested to RED 2014/53/EU Essential Requirements for Health, Safety, and Radio. The applicable standards are:

- **Radio: EN 300 328 V2.2.2 (2019-07)**
- **Health: (SAR) EN 62479:2010**
- **Safety: EN 62368-1:2018, EN IEC 62368-1:2020+A11:2020**
- **EMC: EN 301 489-1 v2.2.3, EN 301 489-17 v3.2.4**

End product will need to perform the radio EMC tests according to EN 301 489. The conducted tests can be inherited from the module test report. It is recommended to repeat the EN 300 328 radiated testing with the end product assembly.

Simplified Declaration of Conformity
Hereby, Renesas Design Netherlands B.V declares that radio type equipment DA14535MOD-00F0100 is in compliance with Directive 2014/53/EU. The full text of the EU declaration of conformity is available at the following internet address: www.renesas.com

14.2 FCC – (U.S.A.)

Model no. DA14535MOD-00F0100

FCC ID: Y82-DA14535MOD

14.2.1 List of Applicable FCC Rules

The module complies with FCC Part 15.247.

14.2.2 Summarize the Specific Operational Use Conditions

The module has been certified for Portable applications. This transmitter must not be co-located or operating in conjunction with any other antenna or transmitter.

14.2.3 Limited Module Procedures

Not applicable.

14.2.4 Trace Antenna Designs

Not applicable.

14.2.5 RF Exposure Considerations

This equipment complies with FCC's RF radiation exposure limits set forth for an uncontrolled environment. The antenna(s) used for this transmitter must not be collocated or operating in conjunction with any other antenna or transmitter.

14.2.6 Antennas

Type	Gain	Impedance	Application
PCB Antenna	-0.5 dBi	50Ω	Fixed

The antenna is permanently attached, cannot be replaced.

14.2.7 Label and Compliance Information

This device complies with part 15 of the FCC rules. Operation is subject to the following two conditions:

1. This device may not cause harmful interference.

2. This device must accept any interference received, including interference that may cause undesired operation.

Note

The manufacturer is not responsible for any radio or TV interference caused by unauthorized modifications or changes to this equipment. Such modifications or changes could void the user's authority to operate the equipment.

Warning

Changes or modifications to this unit not expressly approved by the party responsible for compliance could void the user's authority to operate the equipment.

Note

This equipment has been tested and found to comply with the limits for a Class B digital device, pursuant to part 15 of the FCC Rules. These limits are designed to provide reasonable protection against harmful interference in a residential installation. This equipment generates uses and can radiate radio frequency energy and, if not installed and used in accordance with the instructions, may cause harmful interference to radio communications. However, there is no guarantee that interference will not occur in a particular installation. If this equipment does cause harmful interference to radio or television reception, which can be determined by turning the equipment off and on, the user is encouraged to try to correct the interference by one or more of the following measures:

- Reorient or relocate the receiving antenna.
- Increase the separation between the equipment and receiver.
- Connect the equipment into an outlet on a circuit different from that to which the receiver is connected.
- Consult the dealer or an experienced radio/TV technician for help.

The system integrator must place an exterior label on the outside of the final product housing the DA14535MOD-00F0100 Module. Below are the contents that must be included on this label.

OEM Labeling Requirements:

Notice

The OEM must make sure that FCC labeling requirements are met. This includes a clearly visible exterior label on the outside of the final product housing that displays the contents shown in below:

Model: DA14535MOD-00F0100
Contains FCC ID: Y82-DA14535MOD

14.2.8 Information on Test Modes and Additional Testing Requirements

When testing host product, the host manufacture should follow FCC KDB Publication 996369 D04 Module Integration Guide for testing the host products. The host manufacturer may operate their product during the measurements. In setting up the configurations, if the pairing and call box options for testing do not work, then the host product manufacturer should coordinate with the module manufacturer for access to test mode software.

14.2.9 Additional Testing, Part 15 Subpart B Disclaimer

The modular transmitter is only FCC authorized for the specific rule parts (FCC Part 15.247) list on the grant, and that the host product manufacturer is responsible for compliance to any other FCC rules that apply to the host not covered by the modular transmitter grant of certification. The final host product still requires Part 15 Subpart B compliance testing with the modular transmitter installed when contains digital circuitry.

14.3 IC (Canada)

Model no. DA14535MOD-00F0100

IC ID: 9576A-DA14535MOD

The DA14535 SmartBond TINY™ Module is certified for the IC as a single-modular transmitter. The module meets IC modular approval and labeling requirements. The IC follows the same testing and rules as the FCC regarding certified modules in authorized equipment.

The module has been tested according to the following standards:

- Radio: RSS-247 Issue 2: February 2017, RSS-Gen Issue 5: April 2018+A1: March 2019+A2: February 2021
- Health: RSS-102 Issue 5:2015

This device contains licence-exempt transmitter(s)/receiver(s) that comply with Innovation, Science and Economic Development Canada's licence-exempt RSS(s). Operation is subject to the following two conditions:

(1) This device may not cause interference.

(2) This device must accept any interference, including interference that may cause undesired operation of the device.

L'émetteur/récepteur exempt de licence contenu dans le présent appareil est conforme aux CNR d'Innovation, Sciences et Développement économique Canada applicables aux appareils radio exempts de licence.

L'exploitation est autorisée aux deux conditions suivantes:

1) L'appareil ne doit pas produire de brouillage;

2) L'appareil doit accepter tout brouillage radioélectrique subi, même si le brouillage est susceptible d'en compromettre le fonctionnement.

RF Exposure Statement

This device complies with IC radiation exposure limits set forth for an uncontrolled environment and meets RSS-102 of the IC radio frequency (RF) Exposure rules. This transmitter must not be co-located or operating in conjunction with any other antenna or transmitter.

Le présent appareil est conforme à l'exposition aux radiations IC définies pour un environnement non contrôlé et répond aux RSS-102 de la fréquence radio (RF) IC règles d'exposition. L'émetteur ne doit pas être colocalisé ni fonctionner conjointement avec à autre antenne ou autre émetteur.

OEM Responsibilities to comply with IC Regulations

OEM integrator is responsible for testing their end product for any additional compliance requirements needed for the module installation like IC ES003 (EMC). This can be combined with the FCC Part 15B test.

End product labeling

The DA14535 SmartBond TINY™ Module is labeled with its own IC ID: **9576A-DA14535MOD**. If the IC ID is not visible when the module is installed inside another device, then the host product must be labelled to display the ISED certification number for the module, preceded by the word "contains" or similar wording expressing the same meaning, as follows: Contains IC: **9576A-DA14535MOD**."

14.4 UKCA (UK)

Model no. DA14535MOD-00F0100



The module has been tested and found to comply with the standards harmonized with the regulations listed below according to UKCA-Radio Equipment Regulations 2017-CHAPTER 1 6(1)(a) Health, 6(1)(b) & 6(2).

The applicable standards are:

- Radio: **EN 300 328 V2.2.2 (2019-07)**
- Health: (SAR) **EN 62479:2010**
- Safety: **EN 62368-1:2018, BS EN IEC 62368-1: 2020+A11: 2020**
- EMC: **EN 301 489-1 v2.2.3, EN 301 489-17 v3.2.4**

End-product will need to perform the radio EMC tests according to EN 301 489. The conducted tests can be inherited from the module test report. It is recommended to repeat the EN 300 328 radiated testing with the end-product assembly.

Simplified Declaration of Conformity

Hereby, Renesas Design Netherlands B.V declares that radio type equipment DA14535MOD-00F0100 is in compliance with Radio Equipment Regulations 2017. The full text of the UK declaration of conformity is available at the following internet address: www.renesas.com

14.5 NCC (Taiwan)

Model no. DA14535MOD-00F0100

NCC ID: CCAG23Y10080T7

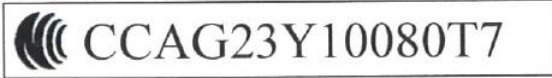

The DA14535 SmartBond TINY™ Module has received compliance approval in accordance with the Telecommunications Act. The module has been tested according to the following standard:

- Radio: Low Power Radio Frequency Devices Technical Regulations (LP0002)

End product may need to follow additional requirements according to the regulation EMC.

注意！

取得審驗證明之低功率射頻器材，非經核准，公司、商號或使用者均不得擅自變更頻率、加大功率或變更原設計之特性及功能。低功率射頻器材之使用不得影響飛航安全及干擾合法通信；經發現有干擾現象時，應立即停用，並改善至無干擾時方得繼續使用。前述合法通信，指依電信管理法規定作業之無線電通信。低功率射頻器材須忍受合法通信或工業、科學及醫療用電波輻射性電機設備之干擾。

End product labeling

The NCC ID can be applied directly to the end product's label.

14.6 MSIP (South Korea)

Model no. DA14535MOD-00F0100

MSIP ID: R-R-8DL-DA14535MOD

DA14535 SmartBond TINY™ Module has received certification of conformity in accordance with Radio Waves Act. The module has been tested according to the following standard:

- Radio: Ministry of Science and ICT Notice No. 2019-105

For the end product wireless test, you can refer to Renesas' own certification report so that the lab knows the module itself has passed although it still needs to be tested.

Additionally, EMC for wireless (KN301489).

End product labeling

The MSIP ID can be applied directly to the end product's label. The ID should be clearly visible on the final end product. The integrator of the module should refer to the labeling requirements for Korea available on the Korea Communications Commission (KCC) website.

14.7 ICASA (South Africa)

Model no. DA14535MOD-00F0100

ICASA ID: TA-2023/2817

South Africa certification is based on RED(CE) approval.



Approval is granted to print labels for the products as described below:

1. For use as Label on the product size: 80 mm (W) X 40 mm (H). To be printed on the product.
 2. For use as Label on the package size: 80 mm (W) X 40 mm (H). To be printed on the package.
- End product may need to follow additional requirements according to the regulation EMC.

14.8 ANATEL (Brazil)

Model no. DA14535MOD-00F0100

ANATEL ID: 05421-24-16689



The module has been tested and found to be compliant according to the following Category II standards:

- ATO (Act) No 14448/2017

End product may need to follow additional requirements according to the regulation EMC.

“Este equipamento não tem direito à proteção contra interferência prejudicial e não pode causar interferência em sistemas devidamente autorizados. Para mais informações consulte o site da ANATEL www.anatel.gov.br”

Translation of the text:

"This equipment is not entitled to protection against harmful interference and must not cause interference in duly authorized systems. For more information, consult the ANATEL website www.anatel.gov.br"

14.9 SRRC (China)

Model no. DA14535MOD-00F0100

CMIIT ID: 2023DP16498

The module has been tested and found to be compliant according to the following standards:

- 信部无【2002】353号

End product may need to follow additional requirements according to the regulation EMC.

14.10 MIC (Japan)

Model no. DA14535MOD-00F0100

MIC ID: 012-230026



The DA14535 SmartBond TINY™ Module has received type certification as required to conform to the technical standards regulated by the Ministry of Internal Affairs and Communications (MIC) of Japan pursuant to the Radio Act of Japan.

The module has been tested according to the following standard:

- Radio: JRL “Article 49-20 and the relevant articles of the Ordinance Regulating Radio” Equipment
End product may need to follow additional requirements according to the regulation EMC.

End product labeling

The MIC ID can be applied directly to the end product's label. **The end product may bear the GITEKI mark and certification number so that is clear that the end product contains a certified radio module. The following note may be shown next to, below, or above the GITEKI mark and certification number in order to indicate the presence of a certified radio module:**

当該機器には電波法に基づく、技術基準適合証明等を受けた特定無線設備を装着している。

Translation of the text:

“This equipment contains specified radio equipment that has been certified to the Technical Regulation Conformity Certification under the Radio Law.”

14.11 NBTC (Thailand)

Model no. DA14535MOD-00F0100

NBTC SDoC ID: SD03391-23

"This telecommunication equipment conforms to the technical standards or requirements of NBTC."

End product may need to follow additional requirements according to the regulation EMC.

End product labeling

End products will have their own ID and labeling requirements.



(Translation of content: This radiocommunication equipment is exempted to possess license, user license, or radiocommunication station license as per NBTC notification regarding radiocommunication equipment and radiocommunication station has been exempted for license according to radio communication act B.E.2498)

14.12 WPC (India)

Model no. DA14535MOD-00F0100

Registration No: ETA-SD-20231110128

India certification is based on RED(CE) approval/reports. There are no **marking/labeling requirements**.

End product may need to follow additional requirements according to the regulation EMC.

14.13 Australia/New Zealand

Model no. DA14535MOD-00F0100

Certification is based on RED(CE) approval.

14.14 WEEE Directive (2012/19/EU)



The Waste Electrical and Electronic Equipment Regulations 2013



For Customers in the UK and European Union

The WEEE (Waste Electrical and Electronic Equipment) regulations put responsibilities on producers for the collection and recycling or disposal of electrical and electronic waste. Return of WEEE under these regulations is applicable in the UK and European Union.

This equipment (including all accessories) is not intended for household use. After use, the equipment cannot be disposed of as household waste, and the WEEE must be treated, recycled, and disposed of in an environmentally sound manner.

Renesas Electronics Europe GmbH can take back the end of life equipment. Register for this service at:

<https://www.renesas.com/eu/en/support/regional-customer-support/weee>

15. Bluetooth SIG Qualification

The DA14535 SmartBond TINY™ Module is listed on the Bluetooth® SIG website as a qualified product. The customers can refer to the following QDIDs to qualify their product:

- QDID 216708 for Host Subsystem
- QDID 216526 for Controller Subsystem.

Revision History

Revision	Date	Description
3.0	June 21, 2024	Datasheet status: Final, Product Status: Production
2.0	Nov 17, 2023	Datasheet status: Preliminary, Product Status: Qualification
1.0	June 22, 2023	Datasheet status: Target, Product Status: Development

Status Definitions

Revision	Datasheet Status	Product Status	Definition
1.<n>	Target	Development	This datasheet contains the design specifications for product development. Specifications may be changed in any manner without notice.
2.<n>	Preliminary	Qualification	This datasheet contains the specifications and preliminary characterization data for products in pre-production. Specifications may be changed at any time without notice in order to improve the design.
3.<n>	Final	Production	This datasheet contains the final specifications for products in volume production. The specifications may be changed at any time in order to improve the design, manufacturing and supply. Major specification changes are communicated via Customer Product Notifications.

RoHS Compliance

Renesas Electronic's suppliers certify that its products are in compliance with the requirements of Directive 2011/65/EU of the European Parliament on the restriction of the use of certain hazardous substances in electrical and electronic equipment. RoHS certificates from our suppliers are available on request.

IMPORTANT NOTICE AND DISCLAIMER

RENESAS ELECTRONICS CORPORATION AND ITS SUBSIDIARIES (“RENESAS”) PROVIDES TECHNICAL SPECIFICATIONS AND RELIABILITY DATA (INCLUDING DATASHEETS), DESIGN RESOURCES (INCLUDING REFERENCE DESIGNS), APPLICATION OR OTHER DESIGN ADVICE, WEB TOOLS, SAFETY INFORMATION, AND OTHER RESOURCES “AS IS” AND WITH ALL FAULTS, AND DISCLAIMS ALL WARRANTIES, EXPRESS OR IMPLIED, INCLUDING, WITHOUT LIMITATION, ANY IMPLIED WARRANTIES OF MERCHANTABILITY, FITNESS FOR A PARTICULAR PURPOSE, OR NON-INFRINGEMENT OF THIRD-PARTY INTELLECTUAL PROPERTY RIGHTS.

These resources are intended for developers who are designing with Renesas products. You are solely responsible for (1) selecting the appropriate products for your application, (2) designing, validating, and testing your application, and (3) ensuring your application meets applicable standards, and any other safety, security, or other requirements. These resources are subject to change without notice. Renesas grants you permission to use these resources only to develop an application that uses Renesas products. Other reproduction or use of these resources is strictly prohibited. No license is granted to any other Renesas intellectual property or to any third-party intellectual property. Renesas disclaims responsibility for, and you will fully indemnify Renesas and its representatives against, any claims, damages, costs, losses, or liabilities arising from your use of these resources. Renesas' products are provided only subject to Renesas' Terms and Conditions of Sale or other applicable terms agreed to in writing. No use of any Renesas resources expands or otherwise alters any applicable warranties or warranty disclaimers for these products.

(Disclaimer Rev.1.01 Jan 2024)

Corporate Headquarters

TOYOSU FORESIA, 3-2-24 Toyosu,
Koto-ku, Tokyo 135-0061, Japan
www.renesas.com

Trademarks

Renesas and the Renesas logo are trademarks of Renesas Electronics Corporation. All trademarks and registered trademarks are the property of their respective owners.

Contact Information

For further information on a product, technology, the most up-to-date version of a document, or your nearest sales office, please visit www.renesas.com/contact-us/.