

---

## High Efficiency, Ultra-Low Quiescent Current and Ultra-Low Output Ripple Buck Regulator

### General Description

DA9232 is a high efficiency, ultra-low quiescent current and ultra-low output ripple buck regulator in a compact I<sup>2</sup>C configurable WLCSP package targeting battery powered applications needing low ripple and highly efficient power supplies.

The battery life of these devices is significantly improved due to the low quiescent current delivered by DA9232 during operation and shutdown.

The buck regulator extends high light load efficiency down to 10  $\mu$ A further extending battery life. Dynamic Voltage Control in the Buck regulator facilitates optimization across the system power modes enabling further improvement in System efficiency and battery life.

DA9232 provides multiple protection features and comes with the ability to monitor the events and indicators in the GPO pin.

Suitable for space constrained applications, the DA9232 comes in a 1.65 mm x 1.25 mm x 0.5 mm, 12-pin WLCSP package.

### Key Features

- 60mA buck regulator
  - 750nA total input current (buck enabled, no load)
  - Up to 81% efficiency at 1.8V output, 10 $\mu$ A load currents
  - Input voltage 2.5V to 5.5V (Minimum 2.75 V for start-up)
  - Output voltage 0.6 V to 1.9 V
- I<sup>2</sup>C interface for device configuration and control
- Protection features and System Monitors
- Small 1.65 mm x 1.25 mm x 0.5 mm, 12-pin WLCSP package
- Dynamic Voltage Control (DVC)

### Applications

- Wearables – wrist wear, hearables
- Smart devices - thermostats and door locks
- Smoke detectors
- Portable medical devices
- Remote sensors
- High efficiency, low power applications

## High Efficiency, Ultra-Low Quiescent Current and Ultra-Low Output Ripple Buck Regulator

### Contents

<b>General Description</b> .....	<b>1</b>
<b>Key Features</b> .....	<b>1</b>
<b>Applications</b> .....	<b>1</b>
<b>Contents</b> .....	<b>2</b>
<b>Figures</b> .....	<b>4</b>
<b>Tables</b> .....	<b>4</b>
<b>1 Terms and Definitions</b> .....	<b>6</b>
<b>2 Block and Application Diagrams</b> .....	<b>7</b>
<b>3 Pinout</b> .....	<b>8</b>
<b>4 Absolute Maximum Ratings</b> .....	<b>10</b>
<b>5 Recommended Operating Conditions</b> .....	<b>11</b>
<b>6 ESD Ratings</b> .....	<b>12</b>
<b>7 Electrical Characteristics</b> .....	<b>13</b>
<b>8 Thermal Characteristics</b> .....	<b>16</b>
<b>9 Typical Operating Characteristics</b> .....	<b>17</b>
9.1 Buck No Load Quiescent Current vs Temperature, Device is Switching.....	17
9.2 RDSon vs Temperature .....	17
9.3 Efficiency vs Load Current .....	18
9.4 Switching Frequency vs Load Current .....	19
9.5 Buck V <sub>OUT</sub> Ripple vs Load Current .....	20
9.6 Buck V <sub>OUT</sub> vs Load Current .....	21
9.7 Typical Mode Operation .....	22
9.8 Buck Load Transient Response .....	23
9.9 Buck Dynamic Voltage Control .....	24
9.10 Device Enable and Start up .....	25
<b>10 Feature Descriptions</b> .....	<b>26</b>
10.1 Chip Enable and Disable Through IC_EN .....	26
10.2 VDD Under-Voltage Lockout.....	26
10.3 Buck Regulator.....	26
10.3.1 Buck Output Voltage Programmability.....	26
10.3.2 Start-up Operation .....	27
10.3.3 Power Saving Mode Operation.....	27
10.3.4 Dynamic Voltage Control .....	28
10.3.5 Cycle-by-cycle Over-Current Protection .....	28
10.3.6 Output Over-Voltage Protection .....	28

## High Efficiency, Ultra-Low Quiescent Current and Ultra-Low Output Ripple Buck Regulator

10.3.7	Output Under-Voltage Protection .....	28
10.3.8	Automatic Output voltage Discharge .....	28
10.3.9	Event Flag and Fault Control.....	29
10.4	I <sup>2</sup> C Programming.....	30
10.4.1	Interface Description.....	30
10.4.2	Details of the I <sup>2</sup> C Protocol.....	30
10.5	GPO Pin Function Programming .....	32
10.5.1	Power Good Indicator.....	32
10.5.2	Event Indicator.....	32
10.5.3	Reset Pulse Generation .....	32
10.5.4	Always Pull-Down or Hi-Z.....	32
<b>11</b>	<b>Register Overview .....</b>	<b>33</b>
11.1	Register Map.....	33
11.1.1	Buck Control .....	33
11.1.2	System Module.....	34
11.2	Register Definitions.....	34
11.2.1	Buck Control .....	34
11.2.1.1	Event/Status/Mask Registers .....	34
11.2.1.2	User Registers.....	37
11.2.2	System Module.....	43
11.2.2.1	System Reset Registers .....	43
11.2.2.2	System ID Registers.....	44
<b>12</b>	<b>Package Information .....</b>	<b>46</b>
12.1	Package Outlines.....	46
12.2	Moisture Sensitivity Level.....	47
12.3	Soldering Information.....	47
<b>13</b>	<b>Ordering Information .....</b>	<b>48</b>

## High Efficiency, Ultra-Low Quiescent Current and Ultra-Low Output Ripple Buck Regulator

### Figures

Figure 1: Block Diagram	7
Figure 2: DA9232 Application Diagram	7
Figure 3: Pinout Diagram (Top View)	8
Figure 4: Buck $V_{OUT} = 1.8\text{ V}$	17
Figure 5: Buck $V_{OUT} = 0.7\text{ V}$	17
Figure 6: High-Side FET	17
Figure 7: Low-Side FET	17
Figure 8: Buck $V_{OUT} = 1.8\text{ V}$	18
Figure 9: Buck $V_{OUT} = 1.2\text{ V}$	18
Figure 10: Buck $V_{OUT} = 0.9\text{ V}$	18
Figure 11: Buck $V_{OUT} = 0.7\text{ V}$	18
Figure 12: Buck $V_{OUT} = 1.8\text{ V}$	19
Figure 13: Buck $V_{OUT} = 1.2\text{ V}$	19
Figure 14: Buck $V_{OUT} = 0.9\text{ V}$	19
Figure 15: Buck $V_{OUT} = 0.7\text{ V}$	19
Figure 16: Buck $V_{OUT} = 1.8\text{ V}$	20
Figure 17: Buck $V_{OUT} = 1.2\text{ V}$	20
Figure 18: Buck $V_{OUT} = 0.9\text{ V}$	20
Figure 19: Buck $V_{OUT} = 0.7\text{ V}$	20
Figure 20: Buck $V_{OUT} = 1.8\text{ V}$	21
Figure 21: Buck $V_{OUT} = 1.2\text{ V}$	21
Figure 22: Buck $V_{OUT} = 0.9\text{ V}$	21
Figure 23: Buck $V_{OUT} = 0.7\text{ V}$	21
Figure 24: Buck $V_{IN} = 3.6\text{ V}$ , Buck $V_{OUT} = 1.8\text{ V}$ , Buck $I_{LOAD} = 1\text{ mA}$	22
Figure 25: Buck $V_{IN} = 3.6\text{ V}$ , Buck $V_{OUT} = 1.8\text{ V}$ , Buck $I_{LOAD} = 60\text{ mA}$	22
Figure 26: Buck $V_{IN} = 3.6\text{ V}$ , Buck $V_{OUT} = 0.7\text{ V}$ , Buck $I_{LOAD} = 1\text{ mA}$	22
Figure 27: Buck $V_{IN} = 3.6\text{ V}$ , Buck $V_{OUT} = 0.7\text{ V}$ , Buck $I_{LOAD} = 60\text{ mA}$	22
Figure 28: Buck $I_{LOAD} = 0.5\text{ mA}$ to $60\text{ mA}$ to $0.5\text{ mA}$ ( $0.1\text{ A}/\mu\text{s}$ ); Buck $V_{IN} = 3.6\text{ V}$ , Buck $V_{OUT} = 1.8\text{ V}$	23
Figure 29: Buck $I_{LOAD} = 0.5\text{ mA}$ to $60\text{ mA}$ to $0.5\text{ mA}$ ( $0.1\text{ A}/\mu\text{s}$ ); Buck $V_{IN} = 3.6\text{ V}$ , Buck $V_{OUT} = 0.7\text{ V}$	23
Figure 30: Buck $V_{OUT} 0.6\text{ V}$ to $1.2\text{ V}$ ; Buck $V_{IN} = 3.6\text{ V}$ , Buck $I_{LOAD} = 60\text{ mA}$	24
Figure 31: Buck $V_{OUT} 1.2\text{ V}$ to $0.6\text{ V}$ ; Buck $V_{IN} = 3.6\text{ V}$ , Buck $I_{LOAD} = 60\text{ mA}$	24
Figure 32: Buck $V_{OUT} 1.3\text{ V}$ to $1.9\text{ V}$ ; Buck $V_{IN} = 3.6\text{ V}$ , Buck $I_{LOAD} = 60\text{ mA}$	24
Figure 33: Buck $V_{OUT} 1.9\text{ V}$ to $1.3\text{ V}$ ; Buck $V_{IN} = 3.6\text{ V}$ , Buck $I_{LOAD} = 60\text{ mA}$	24
Figure 34: Device Enable: Buck $V_{IN} = 3.6\text{ V}$ , Buck $V_{OUT} 1.8\text{ V}$ , Buck $I_{LOAD} = 60\text{ mA}$	25
Figure 35: $V_{OUT}$ ramp-up after Enabled (Zoom-in of	25

### Tables

Table 1: Pin Description	8
Table 2: Pin Type Definition	9
Table 3: Absolute Maximum Ratings	10
Table 4: Recommended Operating Conditions	11
Table 5: Input Current	13
Table 6: Buck Output	13
Table 7: GPO - Electrical performance	14
Table 8: Analog Core - Electrical performance	14
Table 9: I2C interface	15

---

**High Efficiency, Ultra-Low Quiescent Current and  
Ultra-Low Output Ripple Buck Regulator**

---

Table 10: Thermal Characteristics .....	16
Table 11: Buck Output Voltage Settings .....	26
Table 12: GPO as Power Good Indicator.....	32
Table 13: Event/Status/Mask and User Registers .....	33
Table 14: System Reset Registers.....	34
Table 15: Register EVENT .....	34
Table 16: Register STATUS .....	35
Table 17: Register MASK.....	36
Table 18: Register GPO .....	37
Table 19: Register BUCK .....	38
Table 20: Register BUCK_CFG .....	40
Table 21: Register FAUL_CTL .....	41
Table 22: Register PIN_MONITOR .....	42
Table 23: Register SYS_RST_EVENT.....	43
Table 24: Register SYS_SRST .....	43
Table 25: Register SYS_DEVICE_ID.....	44
Table 26: Register SYS_VARIANT_ID.....	44
Table 27: Register SYS_CONFIG_ID .....	45
Table 28: MSL Classification .....	47
Table 29: Ordering Information .....	48
Table 30: OTP List.....	48

---

## High Efficiency, Ultra-Low Quiescent Current and Ultra-Low Output Ripple Buck Regulator

### 1 Terms and Definitions

CDM	Charged Device Model
DC	Direct Current
DCM	Discontinuous Conduction Mode
FET	Field Effect Transistor
NMOS	N-channel Metal-Oxide-Semiconductor
OTP	One-Time Programmable (memory)
PMIC	Power Management IC
PMOS	P-channel Metal-Oxide-Semiconductor
R/W	Read/Write
SCL	Serial Clock SDA
T&R	Tape and Reel
UVLO	Under-Voltage Lock Out
WLCSP	Wafer-Level Chip-Scale Package

High Efficiency, Ultra-Low Quiescent Current and Ultra-Low Output Ripple Buck Regulator

2 Block and Application Diagrams

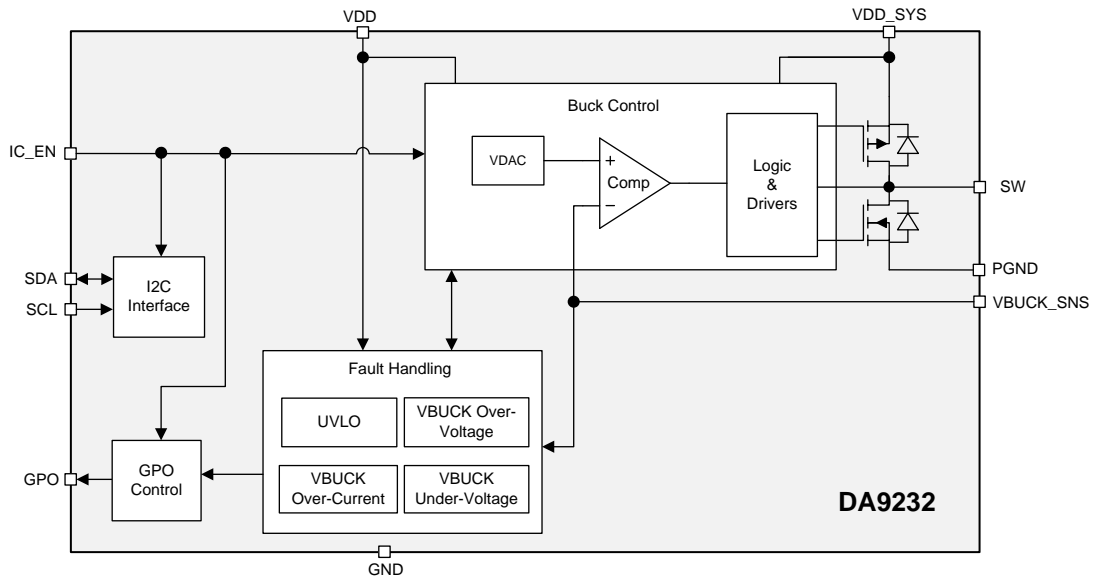

Figure 1: Block Diagram

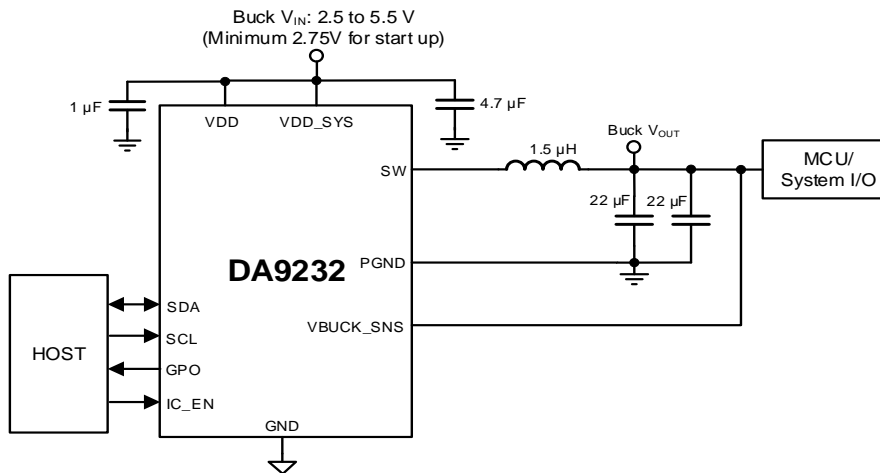

Figure 2: DA9232 Application Diagram

## High Efficiency, Ultra-Low Quiescent Current and Ultra-Low Output Ripple Buck Regulator

### 3 Pinout

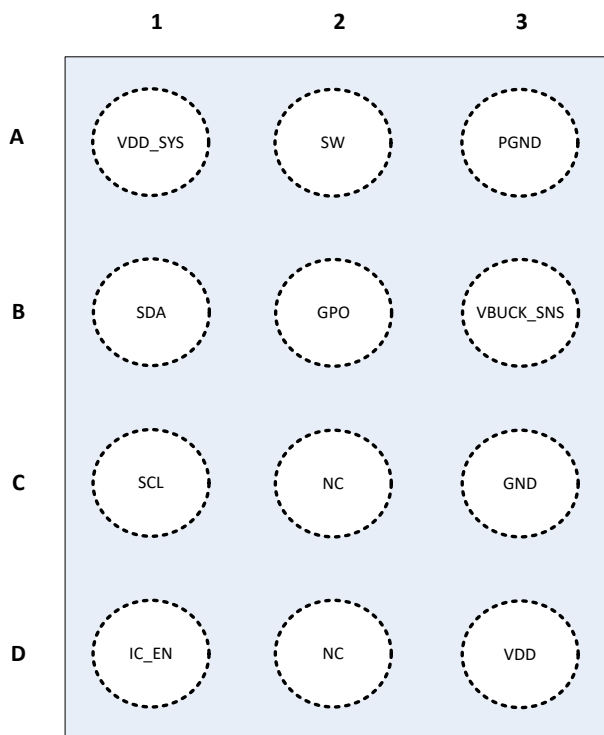

Figure 3: Pinout Diagram (Top View)

Table 1: Pin Description

Pin #	Pin Name	Type (See Table 2)	Drive (mA)	Reset State	Description
A1	VDD_SYS	AI			Buck $V_{IN}$
A2	SW	AIO			Buck switch node
A3	PGND	AIO			Buck ground
B1	SDA	DIO			I <sup>2</sup> C serial data
B2	GPO	DO			General purpose output
B3	VBUCK_SNS	AI			Buck $V_{OUT}$ /feedback voltage
C1	SCL	DI			I <sup>2</sup> C serial clock
C2	NC				No connection
C3	GND	AI			Analog ground
D1	IC_EN	DI			Chip enable



## High Efficiency, Ultra-Low Quiescent Current and Ultra-Low Output Ripple Buck Regulator

Pin #	Pin Name	Type (See Table 2)	Drive (mA)	Reset State	Description
D2	NC				No connection
D3	VDD	AI			Analog $V_{IN}$

**Table 2: Pin Type Definition**

Pin Type	Description	Pin Type	Description
DI	Digital Input	AI	Analog Input
DO	Digital Output	AO	Analog Output
DIO	Digital Input / Output	AIO	Analog Input / Output
DIOD	Digital Input / Output open Drain	BP	Back drive Protection
PU	Fixed pull-up resistor	SPU	Switchable pull-up resistor
PD	Fixed pull-down resistor	SPD	Switchable pull-down resistor

## High Efficiency, Ultra-Low Quiescent Current and Ultra-Low Output Ripple Buck Regulator

### 4 Absolute Maximum Ratings

**Table 3: Absolute Maximum Ratings**

Symbol	Description	Conditions	Min	Max	Unit
T <sub>STG</sub>	Storage temperature		-65	150	°C
T <sub>J</sub>	Operating junction temperature		-40	125	°C
V <sub>DD</sub>	Analog V <sub>IN</sub> pin	Tied to VDD_SYS	-0.3	6	V
V <sub>DD_SYS</sub>	Power V <sub>IN</sub> pin	Tied to VDD	-0.3	6	V
I/O pins	Maximum voltage	I/O pin voltage ≤ VDD	-0.3	6	V

Stresses beyond those listed under Absolute maximum ratings may cause permanent damage to the device. These are stress ratings only, so functional operation of the device at these or any other conditions beyond those indicated in the operational sections of the specification are not implied. Exposure to absolute maximum rating conditions for extended periods may affect device reliability.

## High Efficiency, Ultra-Low Quiescent Current and Ultra-Low Output Ripple Buck Regulator

### 5 Recommended Operating Conditions

**Table 4: Recommended Operating Conditions**

Parameter	Description	Conditions	Min	Typ	Max	Unit
V <sub>DD</sub>	Analog V <sub>IN</sub>	Tied to VDD_SYS	2.5 <a href="#">Note 1</a>		5.5	V
V <sub>DD_SYS</sub>	Power V <sub>IN</sub>	Tied to VDD	2.5 <a href="#">Note 1</a>		5.5	V
I <sub>OUT</sub>	Load Current	Output current from SW pin, continuous DC current			60	mA

**Note 1** Requires minimum 2.75 V for start-up. Once started, input voltage can go down to 2.5 V.

## High Efficiency, Ultra-Low Quiescent Current and Ultra-Low Output Ripple Buck Regulator

### 6 ESD Ratings

Parameter	Description	Conditions	Value	Unit
V <sub>ESD</sub>	Electrostatic discharge	Human body model (HBM), per ANSI/ESDA/JEDEC JS-001 <a href="#">Note 1</a>	± 2000	V
		Charged device model (CDM), per JEDEC specification JESD22-C101 <a href="#">Note 2</a>	± 500	

**Note 1** JEDEC document JEP155 states that 500-V HBM allows safe manufacturing with a standard ESD control process.

**Note 2** JEDEC document JEP157 states that 250-V CDM allows safe manufacturing with a standard ESD control process.

## High Efficiency, Ultra-Low Quiescent Current and Ultra-Low Output Ripple Buck Regulator

### 7 Electrical Characteristics

VDD = VDD\_SYS = 3.6 V, T<sub>A</sub> = -40°C to 85°C. Typical values are at T<sub>A</sub> = 25°C (unless otherwise noted).

**Table 5: Input Current**

Symbol	Parameter	Conditions	Min	Typ	Max	Unit
<b>Electrical performance</b>						
I <sub>Q_BUCK_ON_NO_LD</sub>	Buck no load quiescent current	-40 °C < T <sub>A</sub> < 85 °C Buck enabled and regulating, no load 2.5 V ≤ V <sub>VDD_SYS</sub> ≤ 5.5 V V <sub>BUCK</sub> = 1.8 V		0.75	3.5	μA

**Table 6: Buck Output**

Symbol	Parameter	Conditions	Min	Typ	Max	Unit
<b>Electrical performance</b>						
R <sub>ON_PMOS</sub>	On resistance of PMOS pass device	V <sub>VDD_SYS</sub> = 3.6 V I <sub>OUT</sub> = 50 mA		600	800	mΩ
R <sub>ON_NMOS</sub>	On resistance of NMOS pass device	V <sub>VDD_SYS</sub> = 3.6 V I <sub>OUT</sub> = 50 mA		300	450	mΩ
R <sub>SYS_DHCG</sub>	MOSFET on-resistance for buck discharge	V <sub>VDD_SYS</sub> = 3.6 V I <sub>OUT</sub> = -10 mA into VOUT pin		33		Ω
t <sub>START</sub>	Buck start-up time	V <sub>VDD_SYS</sub> = 3.6 V V <sub>BUCK</sub> = 1.8 V I <sub>OUT</sub> = 0 A from BUCK_EN = 1 to switching start		3		ms
I <sub>LIM_SW_PMOS</sub>	SW current limit PMOS	V <sub>VDD_SYS</sub> = 3.6 V V <sub>BUCK</sub> = 1.8 V		550		mA
f <sub>SW</sub>	Switching frequency in continuous conduction mode				1.5	MHz
I <sub>LIM_PMOS_SOFT_START</sub>	PMOS switch current limit during soft-start	Current limit is reduced during soft-start		250		mA
V <sub>OUT_VBUCK_SNS</sub>	Buck output voltage range	Programmable range, 50 mV steps	0.6		1.9	V

## High Efficiency, Ultra-Low Quiescent Current and Ultra-Low Output Ripple Buck Regulator

Symbol	Parameter	Conditions	Min	Typ	Max	Unit
$V_{OUT\_VBUCK\_SN}$ S_HI	Buck output voltage range	HI programmable range, 50 mV steps $V_{OUT\_RANGE\_HI} = 1$	1.3		1.9	V
$V_{OUT\_VBUCK\_SN}$ S_LO	Buck output voltage range	LO programmable range, 50 mV steps $V_{OUT\_RANGE\_HI} = 0$	0.6		1.3	V
$V_{OUT\_VBUCK\_AC}$ C_HI	Buck output voltage accuracy (Note 1)	$V_{VDD\_SYS} = 2.5 - 5.5V$ $I_{OUT} = 0 - 60\text{ mA}$ $V_{OUT\_RANGE\_HI} = 1$ $V_{BUCK} = 1.8\text{ V}$	-1.5		1.5	%
$V_{OUT\_VBUCK\_AC}$ C_LO	Buck output voltage accuracy (Note 1)	$V_{VDD\_SYS} = 2.5 - 5.5\text{ V}$ $I_{OUT} = 0 - 60\text{ mA}$ $V_{OUT\_RANGE\_HI} = 0$ $V_{BUCK} = 0.7\text{ V}$	-2.5		2.5	%

**Note 1** Includes all variations caused by Line and Load Regulations, Ripple and Temperature.

**Table 7: GPO - Electrical performance**

Symbol	Parameter	Conditions	Min	Typ	Max	Unit
$R_{PD}$	GPO pull-down resistance	$V_{VDD\_SYS} = 3.6\text{ V}$		12		$\Omega$
$V_{OH}$	GPO Output high voltage	$V_{PULLUP} = 1.8\text{ V}$	1.4			V
$V_{OL}$	GPO Output low voltage	$V_{PULLUP} = 1.8\text{ V}$			0.4	V

**Table 8: Analog Core - Electrical performance**

Symbol	Parameter	Conditions	Min	Typ	Max	Unit
$V_{TH\_UVLO}$	Under-voltage lockout threshold	Input voltage falling	2.4		2.5	V
$V_{TH\_UVLO\_RISE}$	Under-voltage lockout threshold rising.	Input voltage rising.			2.75	V
$V_{HYS\_UVLO}$	Under-voltage lockout hysteresis	Input voltage rising		200		mV

## High Efficiency, Ultra-Low Quiescent Current and Ultra-Low Output Ripple Buck Regulator

**Table 9: I2C interface**

Symbol	Parameter	Conditions	Min	Typ	Max	Unit
<b>Electrical performance</b>						
f <sub>I2C_CLK</sub>	I <sup>2</sup> C bus specification standard and fast mode frequency support		100		400	kHz
V <sub>IN_HI_THR</sub>	Input high threshold level for SDA and SCL		1.4			V
V <sub>IN_LO_THR</sub>	Input low threshold level for SDA and SCL				0.4	V
V <sub>OUT_LO_THR</sub>	Output low threshold level for SDA				0.4	V
I <sub>LKG_HILVL</sub>	High-level leakage current for SDA and SCL.	V <sub>PU</sub> = V <sub>VDD</sub> SDA and SCL			1	μA

---

**High Efficiency, Ultra-Low Quiescent Current and  
Ultra-Low Output Ripple Buck Regulator**

## 8 Thermal Characteristics

**Table 10: Thermal Characteristics**

Parameter	Description	Conditions	Typ	Unit
$R_{TH\_JA}$	Junction-to-ambient thermal resistance	JEDEC 6-layer pcb, no airflow	73.2	°C/W
$\Psi_{JT}$	Junction-to-top characterization parameter	JEDEC 6-layer pcb, no airflow	6.66	°C/W
$R_{TH\_JB}$	Junction-to-board thermal resistance	JEDEC 6-layer pcb, no airflow	34.8	°C/W



## High Efficiency, Ultra-Low Quiescent Current and Ultra-Low Output Ripple Buck Regulator

### 9 Typical Operating Characteristics

Test Circuit of Figure 2, Buck  $V_{IN} = VDD\_SYS = VDD$ ,  $T_A = 25^\circ C$ , unless specified otherwise.

#### 9.1 Buck No Load Quiescent Current vs Temperature, Device is Switching

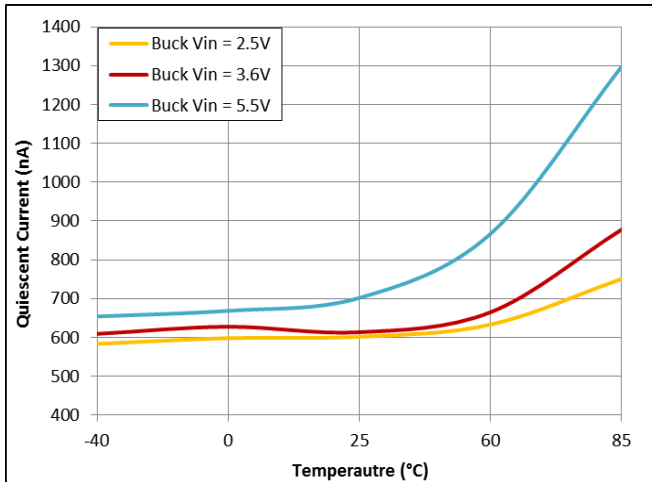

Figure 4: Buck  $V_{OUT} = 1.8\text{ V}$

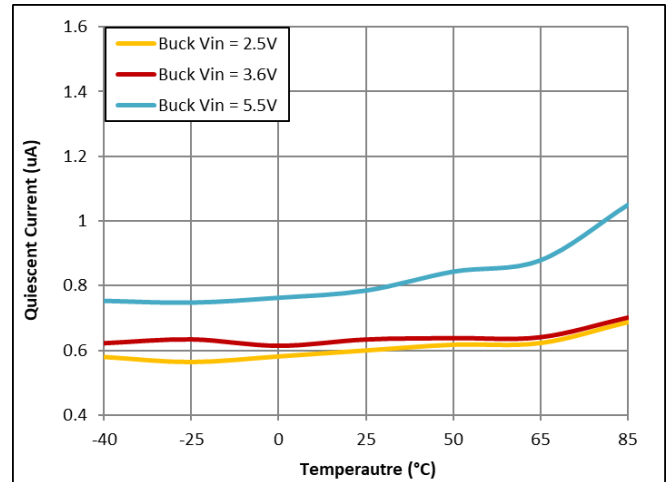

Figure 5: Buck  $V_{OUT} = 0.7\text{ V}$

#### 9.2 $R_{DSon}$ vs Temperature

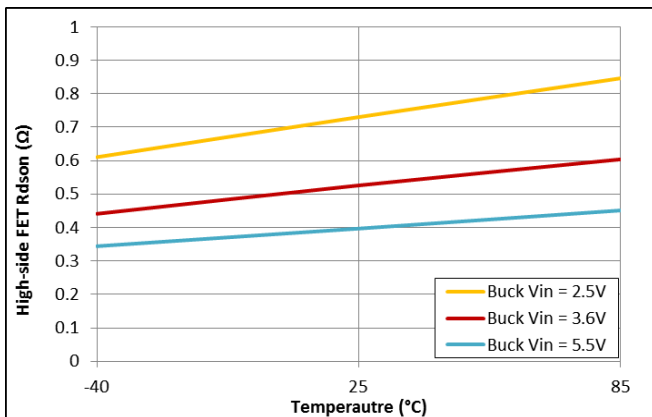

Figure 6: High-Side FET

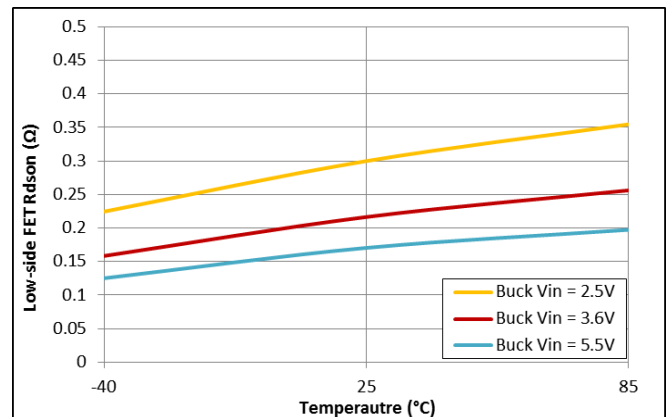

Figure 7: Low-Side FET

High Efficiency, Ultra-Low Quiescent Current and Ultra-Low Output Ripple Buck Regulator

9.3 Efficiency vs Load Current

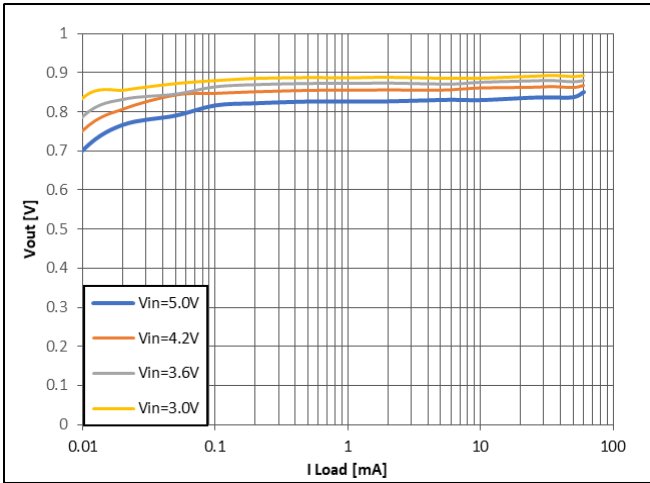

Figure 8: Buck  $V_{OUT} = 1.8\text{ V}$

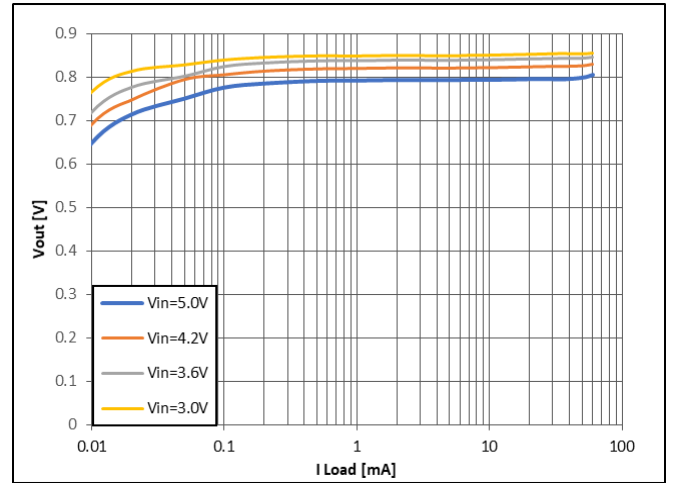

Figure 9: Buck  $V_{OUT} = 1.2\text{ V}$

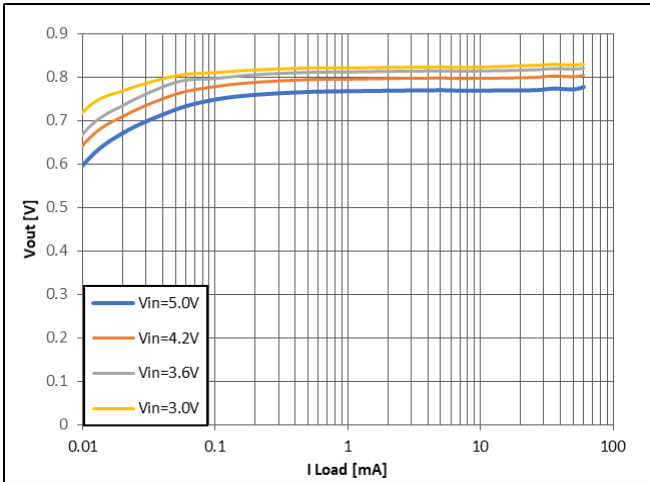

Figure 10: Buck  $V_{OUT} = 0.9\text{ V}$

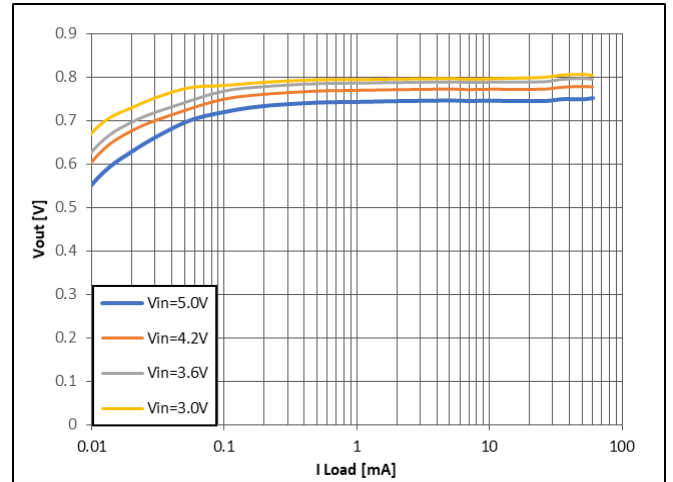

Figure 11: Buck  $V_{OUT} = 0.7\text{ V}$

High Efficiency, Ultra-Low Quiescent Current and Ultra-Low Output Ripple Buck Regulator

9.4 Switching Frequency vs Load Current

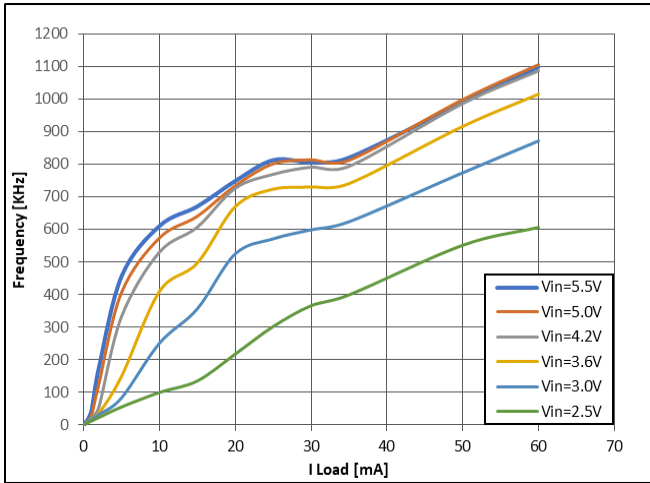

Figure 12: Buck  $V_{OUT} = 1.8\text{ V}$

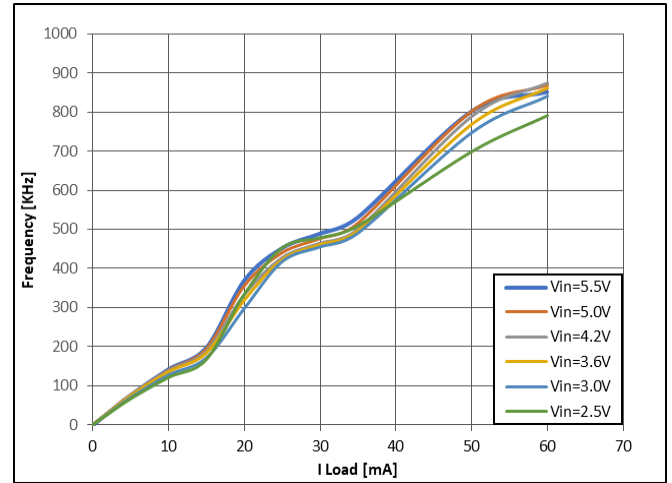

Figure 13: Buck  $V_{OUT} = 1.2\text{ V}$

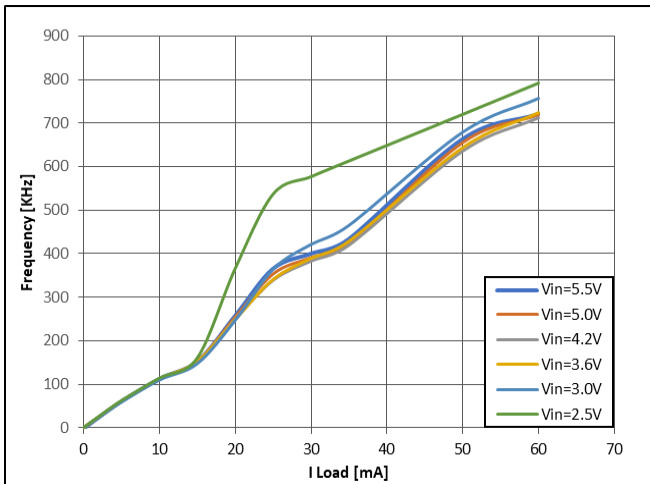

Figure 14: Buck  $V_{OUT} = 0.9\text{ V}$

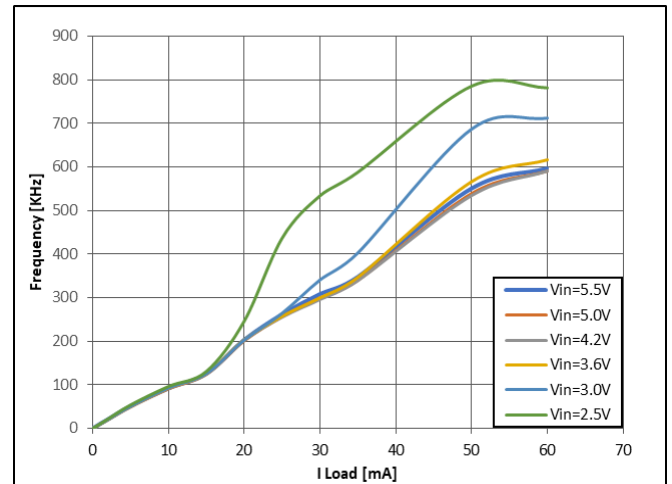

Figure 15: Buck  $V_{OUT} = 0.7\text{ V}$

High Efficiency, Ultra-Low Quiescent Current and Ultra-Low Output Ripple Buck Regulator

9.5 Buck V<sub>OUT</sub> Ripple vs Load Current

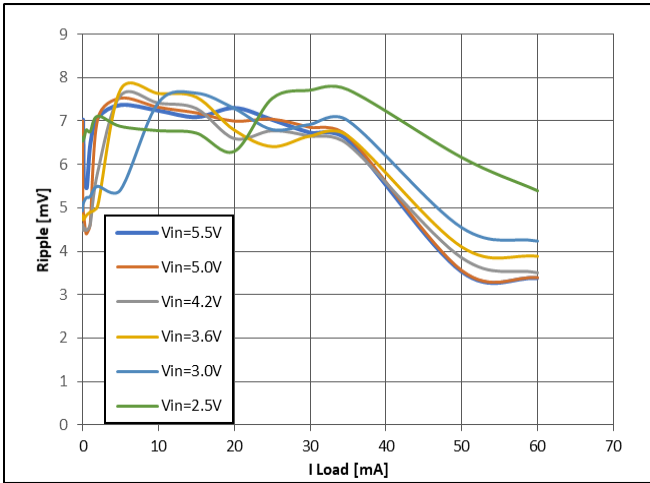

Figure 16: Buck V<sub>OUT</sub> = 1.8 V

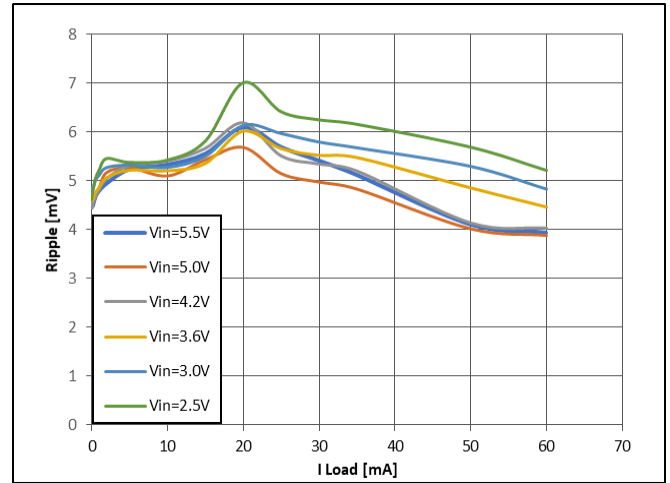

Figure 17: Buck V<sub>OUT</sub> = 1.2 V

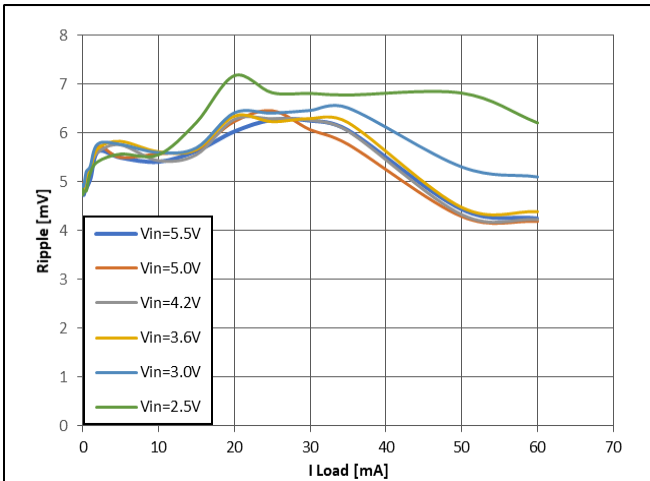

Figure 18: Buck V<sub>OUT</sub> = 0.9 V

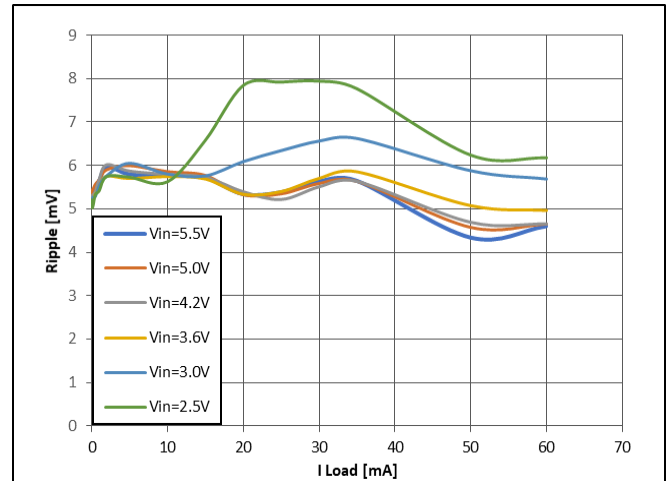

Figure 19: Buck V<sub>OUT</sub> = 0.7 V

High Efficiency, Ultra-Low Quiescent Current and Ultra-Low Output Ripple Buck Regulator

9.6 Buck  $V_{OUT}$  vs Load Current

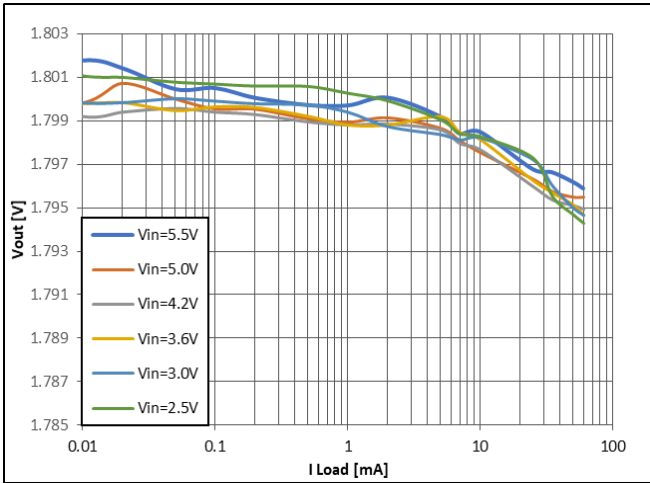

Figure 20: Buck  $V_{OUT} = 1.8\text{ V}$

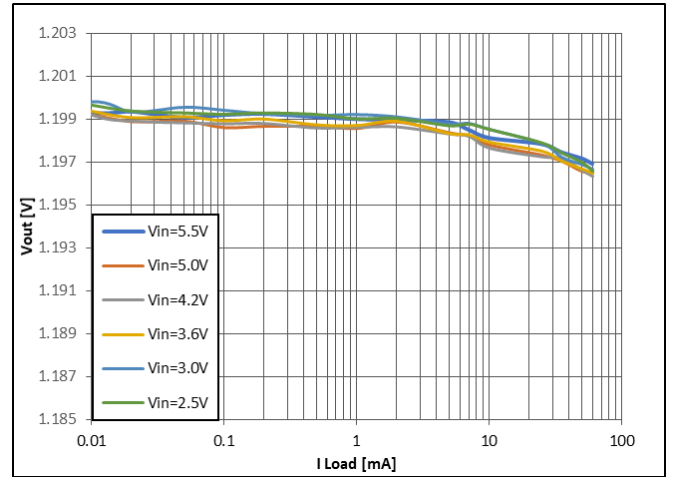

Figure 21: Buck  $V_{OUT} = 1.2\text{ V}$

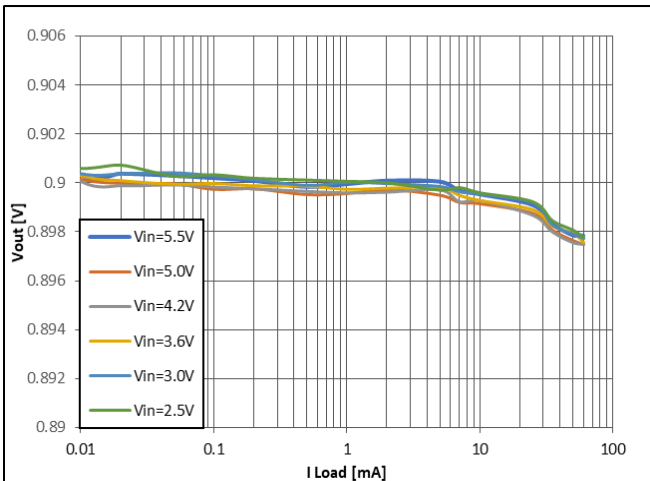

Figure 22: Buck  $V_{OUT} = 0.9\text{ V}$

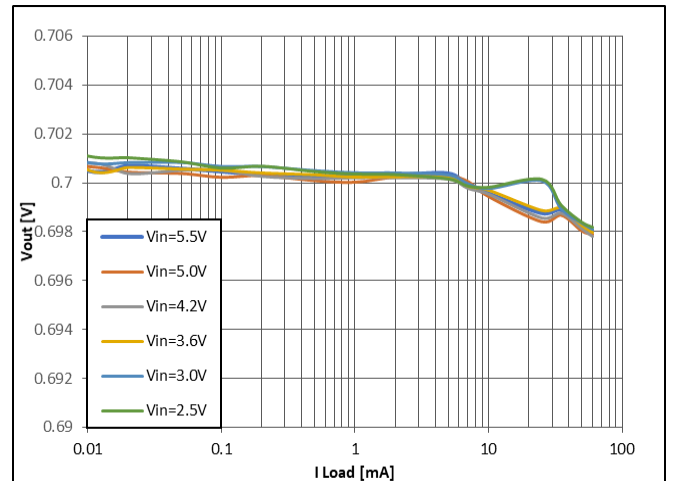

Figure 23: Buck  $V_{OUT} = 0.7\text{ V}$

High Efficiency, Ultra-Low Quiescent Current and Ultra-Low Output Ripple Buck Regulator

9.7 Typical Mode Operation

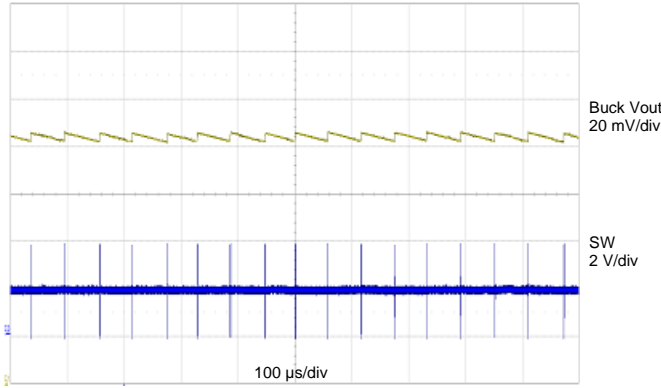

Figure 24: Buck  $V_{IN} = 3.6\text{ V}$ , Buck  $V_{OUT} = 1.8\text{ V}$ , Buck  $I_{LOAD} = 1\text{ mA}$

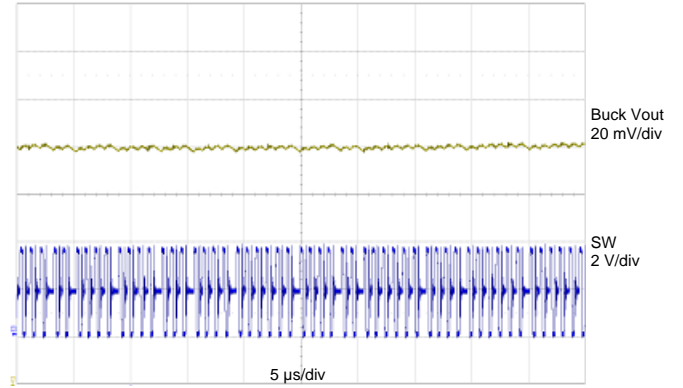

Figure 25: Buck  $V_{IN} = 3.6\text{ V}$ , Buck  $V_{OUT} = 1.8\text{ V}$ , Buck  $I_{LOAD} = 60\text{ mA}$

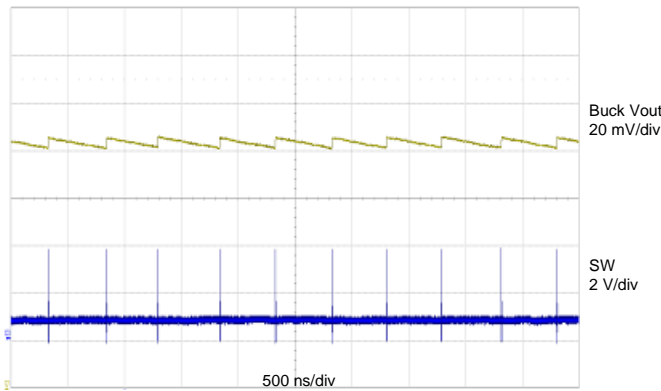

Figure 26: Buck  $V_{IN} = 3.6\text{ V}$ , Buck  $V_{OUT} = 0.7\text{ V}$ , Buck  $I_{LOAD} = 1\text{ mA}$

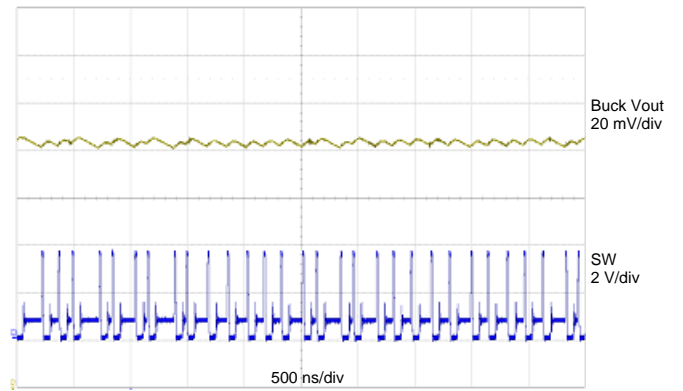
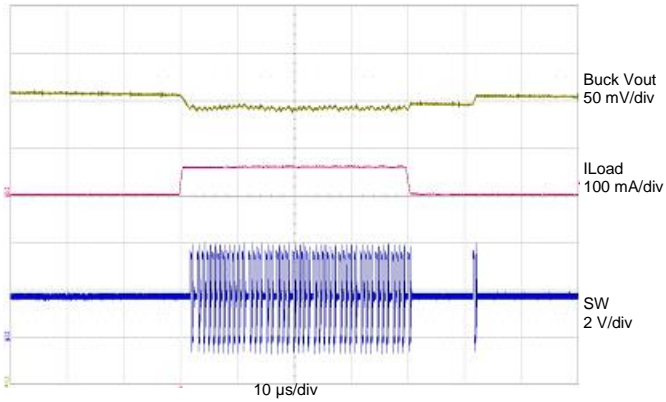

Figure 27: Buck  $V_{IN} = 3.6\text{ V}$ , Buck  $V_{OUT} = 0.7\text{ V}$ , Buck  $I_{LOAD} = 60\text{ mA}$

## High Efficiency, Ultra-Low Quiescent Current and Ultra-Low Output Ripple Buck Regulator

### 9.8 Buck Load Transient Response



**Figure 28: Buck  $I_{LOAD} = 0.5 \text{ mA}$  to  $60 \text{ mA}$  to  $0.5 \text{ mA}$  ( $0.1 \text{ A}/\mu\text{s}$ ); Buck  $V_{IN} = 3.6 \text{ V}$ , Buck  $V_{OUT} = 1.8 \text{ V}$**

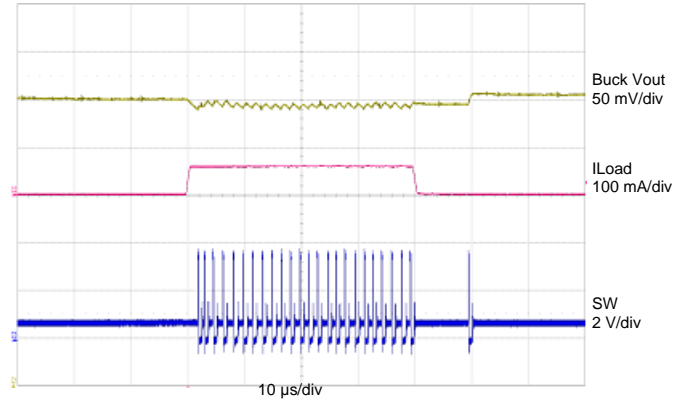

**Figure 29: Buck  $I_{LOAD} = 0.5 \text{ mA}$  to  $60 \text{ mA}$  to  $0.5 \text{ mA}$  ( $0.1 \text{ A}/\mu\text{s}$ ); Buck  $V_{IN} = 3.6 \text{ V}$ , Buck  $V_{OUT} = 0.7 \text{ V}$**

High Efficiency, Ultra-Low Quiescent Current and Ultra-Low Output Ripple Buck Regulator

9.9 Buck Dynamic Voltage Control

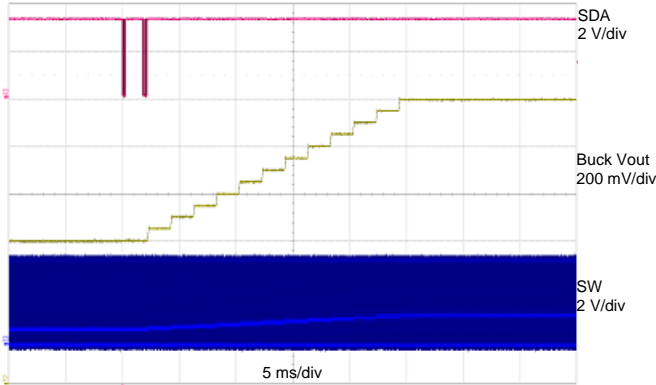

**Figure 30: Buck V<sub>OUT</sub> 0.6 V to 1.2 V;  
Buck V<sub>IN</sub> = 3.6 V, Buck I<sub>LOAD</sub> = 60 mA**

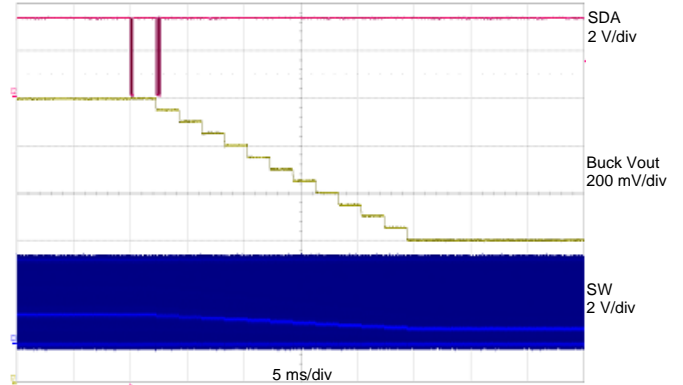

**Figure 31: Buck V<sub>OUT</sub> 1.2 V to 0.6 V;  
Buck V<sub>IN</sub> = 3.6 V, Buck I<sub>LOAD</sub> = 60 mA**

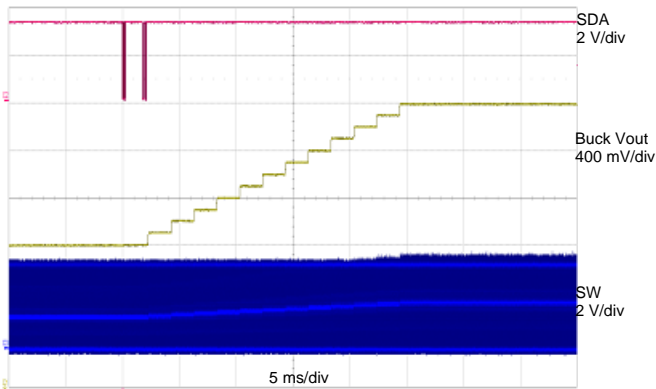

**Figure 32: Buck V<sub>OUT</sub> 1.3 V to 1.9 V;  
Buck V<sub>IN</sub> = 3.6 V, Buck I<sub>LOAD</sub> = 60 mA**

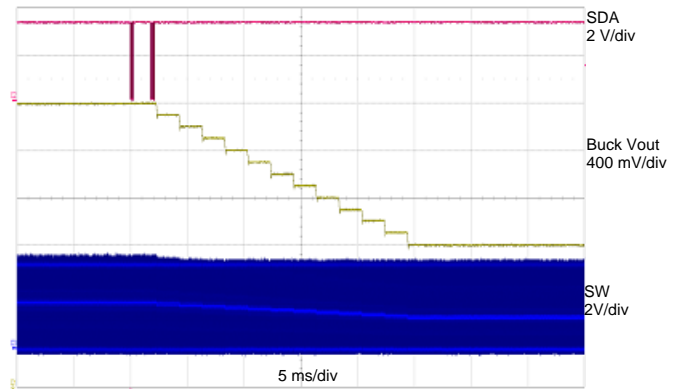
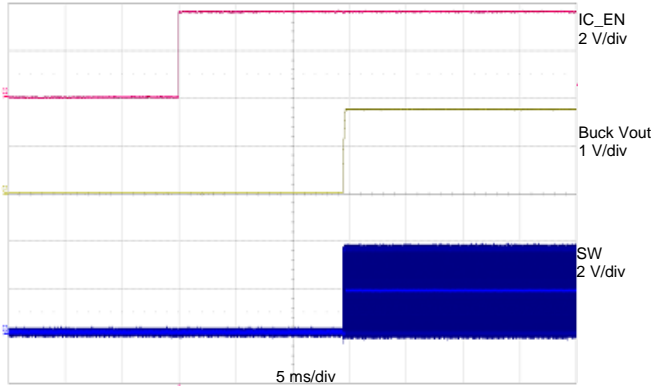

**Figure 33: Buck V<sub>OUT</sub> 1.9 V to 1.3 V;  
Buck V<sub>IN</sub> = 3.6 V, Buck I<sub>LOAD</sub> = 60 mA**



High Efficiency, Ultra-Low Quiescent Current and Ultra-Low Output Ripple Buck Regulator

9.10 Device Enable and Start up



**Figure 34: Device Enable:**  
 Buck  $V_{IN} = 3.6\text{ V}$ , Buck  $V_{OUT} 1.8\text{ V}$ ,  
 Buck  $I_{LOAD} = 60\text{ mA}$

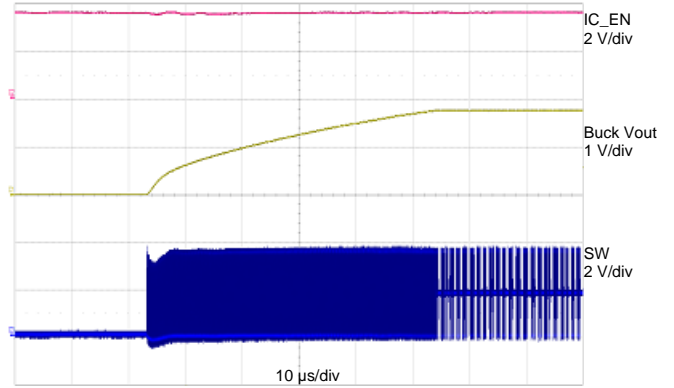

**Figure 35:  $V_{OUT}$  ramp-up after Enabled**  
 (Zoom-in of 34)

## High Efficiency, Ultra-Low Quiescent Current and Ultra-Low Output Ripple Buck Regulator

### 10 Feature Descriptions

#### 10.1 Chip Enable and Disable Through IC\_EN

DA9232 features a dedicated IC\_EN pin to enable and disable the chip. When IC\_EN = high, the device is turned on. IC\_EN voltage should not exceed VDD\_SYS voltage on the device. When EN = low, the device is shut down completely, including I<sup>2</sup>C communications.

#### 10.2 VDD Under-Voltage Lockout

DA9232 features an under-voltage lockout (UVLO) on VDD. When VDD falls below UVLO falling threshold, buck is disabled, see Section 10.3.9 for fault behaviour and control, A VIN\_UV\_Event will be flagged if it is not masked. When VDD rises above the UVLO rising threshold, the device will be alive. VDD should be always tied to VDD\_SYS on the PCB board so both VDD and VDD\_SYS will share the same UVLO protection.

#### 10.3 Buck Regulator

DA9232 includes a nano-ampere standby buck regulator with an adjustable output voltage, Dynamic Voltage Scaling capability and a maximum load current of 60 mA. It also has power saving mode operation and different protection features.

##### 10.3.1 Buck Output Voltage Programmability

The DA9232 buck regulator can be set to two different ranges based on the value of VOUT\_RANGE\_HI. The value of BUCK\_VOUT<4:0> is locked to a certain range based on the value of VOUT\_RANGE\_HI, and VOUT\_RANGE\_HI can only be changed while the buck is disabled. The buck can be set to the output voltages shown in Table 11. If a command is received outside of the allowable range (that is above 1.3 V for VOUT\_RANGE\_HI = 0 or below 1.3 V for VOUT\_RANGE\_HI = 1), digital will force the value of BUCK\_VOUT<3:0> to 01110 (1.3 V).

**Table 11: Buck Output Voltage Settings**

VOUT_RANGE_HI	BUCK_VOUT<4:0>	Buck Output Voltage (V)
0	00000	0.60
0	00001	0.65
0	00010	0.70
0	00011	0.75
0	00100	0.80
0	00101	0.85
0	00110	0.90
0	00111	0.95
0	01000	1.00
0	01001	1.05

## High Efficiency, Ultra-Low Quiescent Current and Ultra-Low Output Ripple Buck Regulator

VOUT_RANGE_HI	BUCK_VOUT<4:0>	Buck Output Voltage (V)
0	01010	1.10
0	01011	1.15
0	01100	1.20
0	01101	1.25
0 or 1	01110	1.30
1	01111	1.35
1	10000	1.40
1	10001	1.45
1	10010	1.50
1	10011	1.55
1	10100	1.60
1	10101	1.65
1	10110	1.70
1	10111	1.75
1	11000	1.80
1	11001	1.85
1	11010	1.90
1	11011	1.90
1	11100	1.90
1	11101	1.90
1	11110	1.90
1	11111	1.90

### 10.3.2 Start-up Operation

DA9232 buck integrates a start-up circuit to minimize output voltage over-shoot and input voltage drop during start-up. When writing 1 to BUCK\_EN (Bit 7 of Reg0x05), the buck is enabled and starts switching after a typical delay time of 3 ms. During start-up, the cycle-by-cycle current limit is reduced to limit inrush current.

### 10.3.3 Power Saving Mode Operation

DA9232 buck regulator features power saving mode that greatly reduces the quiescent current when device has very light load condition. Buck regulator operates in discontinuous mode with Pulse Frequency Modulation (PFM). The low-side FET will be turned off based on a zero-crossing comparator to prevent negative inductor current flowing through the FET which can result in

---

## High Efficiency, Ultra-Low Quiescent Current and Ultra-Low Output Ripple Buck Regulator

additional conduction loss. If both FETs remain in the OFF state for a certain delay time after inductor current crosses zero, the device will enter power saving mode. In power saving mode, DA9232 shuts down most of the internal circuitry to save current consumption. The lighter the load, the longer the duration of power saving mode will be, to achieve the lowest quiescent current and improve light load efficiency.

### 10.3.4 Dynamic Voltage Control

DA9232 buck regulator has dynamic voltage control (DVC) feature which allows the buck output voltage to track the internal reference voltage when it changes at a rate of 50 mV/2 ms. Since the buck output voltage can only be changed within an allowable range while still keeping the buck enabled, DVC also follows the same behaviour. The DVC is done via I<sup>2</sup>C, whereby the buck output voltage setting is stepped in 50 mV steps within either the low range or high range. Each voltage step lasts for 2 ms.

### 10.3.5 Cycle-by-cycle Over-Current Protection

For the Over-current Protection (OCP) in DA9232, the peak current through high-side FET is monitored cycle-by-cycle. When the sensed current exceeds the pre-set current limit, the high-side FET will be turned OFF immediately to limit the inductor current. The high-side FET will be turned on again after the constant-off time expires. If the OC condition persists for 64  $\mu$ s, buck will be forced off and buck output will be pull-down until the fault clears, see Section 10.3.9 for fault behavior and control and Section 10.3.8 for output voltage discharge and control. An OC\_BUCK\_Event will be flagged if it is not masked.

### 10.3.6 Output Over-Voltage Protection

DA9232 features an output over-voltage protection (OVP) to protect the load from damage. When both IC\_EN and BUCK\_EN are high and the buck output voltage is 200 mV greater than the internal reference voltage, the high side FET is immediately OFF, see Section 10.3.9 for fault behavior and control. Then the internal buck output discharge FET will be turned on to discharge buck output capacitor, see Section 10.3.8 for output voltage discharge and control. An OV\_BUCK\_Event will be flagged if it is not masked. Buck will remain off and buck output will be pull-down until the fault is cleared.

### 10.3.7 Output Under-Voltage Protection

When buck output short happens, inductor current will increase until the peak reaches the cycle-by-cycle current limit. Then the high-side FET turns OFF and low-side FET turns on. Since buck output is shorted, inductor current slope is very small during low-side FET on time. The inductor current could gradually go higher and higher. To effectively prevent the inductor current running away at V<sub>OUT</sub> short condition, buck V<sub>OUT</sub> is also monitored. If over-current condition happens and buck V<sub>OUT</sub> drops 400 mV below the reference voltage, the buck regulator will be shut off immediately and an UV\_BUCK\_Event will be flagged if it is not masked, see Section 10.3.9 for fault behavior and control.

### 10.3.8 Automatic Output voltage Discharge

To speed up the discharging of buck output capacitor and ensure a safer start-up next time, the buck regulator provides automatic output voltage discharge when IC\_EN is pulled low or buck shutdown caused by any fault. Automatic output discharge when buck is forced OFF by fault needs to set

---

## High Efficiency, Ultra-Low Quiescent Current and Ultra-Low Output Ripple Buck Regulator

register bit BUCK\_PD\_CFG1 = 0; automatic output discharge when buck is disabled by BUCK\_EN = 0 needs to set register bit BUCK\_PD\_CFG2 = 0. The output of the buck regulator is discharged through VBUCK\_SNS pin and an internal buck output discharge FET with typical 33  $\Omega$  resistance.

### 10.3.9 Event Flag and Fault Control

DA9232 has the flexibility for customers to control the behavior of buck when there is a fault condition. There are five register bits (UVLO\_FRC\_DIS, OV\_DIS\_BUCK, OC\_BUCK\_EVENT, SC\_DIS\_BUCK) controlling whether the buck will be disabled when the corresponding fault condition happens. In addition, users can choose whether to mask or unmask the event flag when the fault condition happens.

When there is a VDD Under-voltage condition, buck will be forced OFF if UVLO\_FRC\_DIS = 1. Buck will remain alive if UVLO\_FRC\_DIS = 0. During the VDD Under-voltage condition, the event register bit VIN\_UV\_EVENT = 1 if the corresponding mask register bit M\_VIN\_UV is set to 0 otherwise VIN\_UV\_EVENT = 0.

When there is an over-voltage fault at buck output, buck will be forced OFF if OV\_DIS\_BUCK = 1. Buck will continue switching if OV\_DIS\_BUCK = 0. During the fault, OV\_BUCK\_EVENT is set to 1 if M\_OV\_BUCK\_EVENT = 0 otherwise OV\_BUCK\_EVENT = 0.

When the over-current condition in buck persists for 64  $\mu$ s and M\_OC\_BUCK\_EVENT is set to 0, OC\_BUCK\_EVENT will be set to 1. If OC\_DIS\_BUCK = 1, BUCK is forced disabled. If OC\_DIS\_BUCK = 0, buck will continue switching during the over-current condition.

When there is a buck Output under-voltage condition and M\_UV\_BUCK\_EVENT = 0, UV\_BUCK\_EVENT is set to 1. If both buck output under-voltage and over-current condition exist and SC\_DIS\_BUCK = 1, buck will be forced OFF. If SC\_DIS\_BUCK = 0, buck will continue switching without shutting down by the under-voltage protection.

DA9232 also has a fault recovery mechanism that can be customized through the 3-bits RCVRY\_NUM. This value determines the fault recovery trial number for buck and is counted down by every fault that triggers buck OFF. When RCVRY\_NUM reaches 0, recovery trial is ended and buck will remain OFF even if the buck enable signals are toggled HI. If RCVRY\_NUM is set to 0x7, there will be no count down on the recovery trial number and recovery trail will not be ended. Before RCVRY\_NUM reaches 0, buck will be recovered automatically if the fault condition disappears.

Event flags are not automatically cleared when the fault conditions disappear. They have to be cleared by changing the values in register EVENT through I<sup>2</sup>C.

## High Efficiency, Ultra-Low Quiescent Current and Ultra-Low Output Ripple Buck Regulator

### 10.4 I<sup>2</sup>C Programming

#### 10.4.1 Interface Description

DA9232 includes an I<sup>2</sup>C compatible interface based on the following signals:

- SCL: standard 400 kHz I<sup>2</sup>C bus serial clock generated by the Host processor
- SDA: standard 400 kHz I<sup>2</sup>C bus serial address/data input output

SDA and SCL are open drain I/O terminals. The standard frequency of the I<sup>2</sup>C bus is 400 kHz in fast mode or 100 kHz in slow mode.

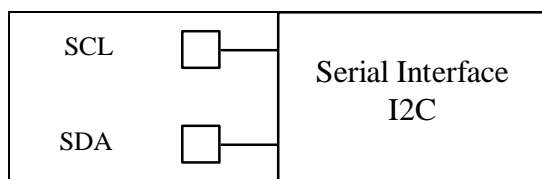

**Figure 36: I<sup>2</sup>C Serial Interface Pins**

The I<sup>2</sup>C bus is used to control most functions and change register values depending on the application requirements. In active battery, the I<sup>2</sup>C circuitry is powered from the battery. The interface maintains a proper operation as long as VDD\_SYS is valid.

The device is compatible with the standard I<sup>2</sup>C protocol but only operates as a slave. The transfer protocol is the same whether operating in fast or slow mode.

#### 10.4.2 Details of the I<sup>2</sup>C Protocol

The device supports 7-bit addressing only, the address is 0x2F. The 8-bit shifted address is 0x5E. A timer runs during I<sup>2</sup>C transitions. If the timer expires while SDA is held low, all additional commands are ignored and the I<sup>2</sup>C state machine is reset. The timer is reset with a START condition and stopped with a STOP condition.

The I<sup>2</sup>C bus is monitored at all times for a valid SLAVE address, and an acknowledge bit is generated if the SLAVE address was true.

- A START condition is initiated by a high to low transition on the SDA line while the SCL is in the high state.
- A STOP condition is indicated by a low to high transition on the SDA line while the SCL is in the high state.
- An ACKNOWLEDGE is indicated by the receiver pulling the SDA line low during the following clock cycle.

## High Efficiency, Ultra-Low Quiescent Current and Ultra-Low Output Ripple Buck Regulator

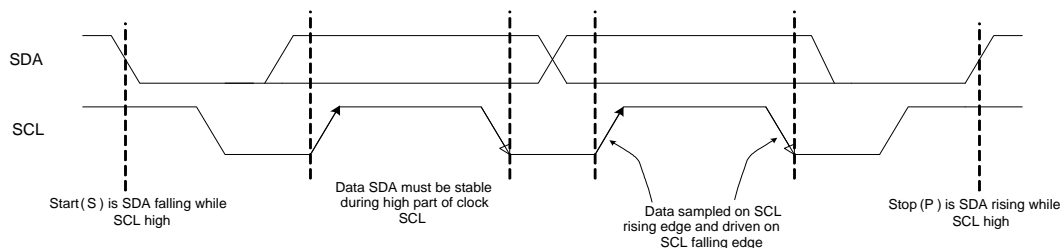

**Figure 37: I<sup>2</sup>C Start and Stop Conditions**

When the address is matching the following event sequence happens:

1. The device generates an ACKNOWLEDGE to indicate to the master that the communication link has been established
2. The master generates SCL clock cycles to transmit or receive data
3. After receiving data, an ACKNOWLEDGE is generated either by the device or the master (whichever is transmitting the data)  
A data sequence is 9-bit, consisting of 8-bit data and 1-bit ACKNOWLEDGE. It can be repeated as long as necessary.
4. The master generates a STOP condition to end the data transfer

The bus returns to IDLE-mode if during a message a new START or STOP condition occurs. Data is transmitted MSB first for both R/W operations.

## High Efficiency, Ultra-Low Quiescent Current and Ultra-Low Output Ripple Buck Regulator

### 10.5 GPO Pin Function Programming

DA9232 has a General-purpose output (GPO) pin which can be programmed to have multiple functions.

#### 10.5.1 Power Good Indicator

When GPO pin is configured to the VDD power good indicator, it is an open drain output and can be configured to either active high or active low. When GPO status is Hi-Z, an external pull-up is required for GPO to be high.

**Table 12: GPO as Power Good Indicator**

GPO Configuration	$V_{IN} > V_{IN\_UVLO}$	GPO Status
Active High	No	0
	Yes	Hi-Z
Active Low	No	Hi-Z
	Yes	0

#### 10.5.2 Event Indicator

GPO pin can also be configured as the event indicator in open drain output. Whenever there is an event or multiple events (VIN\_UV\_EVNT or OV\_BUCK\_EVENT or OC\_BUCK\_EVENT or UV\_BUCK\_EVENT) happen, GPO will be pulled down Low. This can be used as an interrupt to host CPU to inform events happened. When there is no event, GPO will remain in Hi-Z status and an external pull-up is required for GPO to be high.

#### 10.5.3 Reset Pulse Generation

GPO pin can be configured to generate a reset pulse signal when buck starts. The reset signal can be used by host CPU or other device that are connected to buck output. When GPO is Low, it indicates a reset pulse period; when GPO is in Hi-Z status (An external pull-up is required for GPO to be high), it indicates a non-reset period.

There is also a timing control to negate the reset pulse signal. The GPO reset pulse width can be adjusted between 8 and 112 ms measured from written 1 to BUCK\_EN register bit.

#### 10.5.4 Always Pull-Down or Hi-Z

When GPO pin is not used, it can be configured to either always Hi-Z or pull-down to Low.



## High Efficiency, Ultra-Low Quiescent Current and Ultra-Low Output Ripple Buck Regulator

### 11 Register Overview

#### 11.1 Register Map

##### 11.1.1 Buck Control

**Table 13: Event/Status/Mask and User Registers**

User Registers									
Register	Addr	7	6	5	4	3	2	1	0
EVENT	0x0000	Reserved	VIN_UV_EVENT	Reserved	OC_BUCK_EVENT	OV_BUCK_EVENT	UV_BUCK_EVENT	Reserved	Reserved
STATUS	0x0002	Reserved	VIN_UV_STAT	Reserved	OC_BUCK_STAT	OV_BUCK_STAT	UV_BUCK_STAT	Reserved	BUCK_EN_STAT
MASK	0x0003	Reserved	M_VIN_UV	Reserved	M_OC_BUCK_EVENT	M_OV_BUCK_EVENT	M_UV_BUCK_EVENT	Reserved	Reserved
GPO	0x0004	GPO_RST_CTRL<3:0>				GPO_CTRL<3:0>			
BUCK	0x0005	BUCK_EN	VOUT_RANGE_HI	Reserved	BUCK_VOUT<4:0>				
BUCK_CFG	0x0006	Reserved	Reserved	BUCK_PD_CFG2	BUCK_PD_CFG1	Reserved	Reserved	SEL_BUCK_ILIM<1:0>	
FAULT_CTL	0x0008	SC_DIS_BUCK	OC_DIS_BUCK	OV_DIS_BUCK	TSD_FRC_DIS	UVLO_FRC_DIS	RCVRY_NUM<2:0>		
PIN_MONTOR	0x000A	Reserved	Reserved	Reserved	Reserved	Reserved	Reserved	Reserved	GPO_OUT_MON

## High Efficiency, Ultra-Low Quiescent Current and Ultra-Low Output Ripple Buck Regulator

### 11.1.2 System Module

**Table 14: System Reset Registers**

User Registers									
Register	Addr	7	6	5	4	3	2	1	0
SYS_RST_EVENT	0x0001	Reserved	Reserved	Reserved	Reserved	Reserved	Reserved	Reserved	RESET_EVENT
SYS_SRST	0x0009	Reserved	Reserved	Reserved	Reserved	SRST<3:0>			
SYS_DEVICE_ID	0x0080	DEV_ID<7:0>							
SYS_VARIANT_ID	0x0081	MRC<3:0>				VRC<3:0>			
SYS_CONFIG_ID	0x0082	CONFIG_REV<7:0>							

## 11.2 Register Definitions

### 11.2.1 Buck Control

#### 11.2.1.1 Event/Status/Mask Registers

**Table 15: Register EVENT**

Address	Register Name	POR Value	Event flag						
0x0000	EVENT	0x00							
7	6	5	4	3	2	1	0		
Reserved	VIN_UV_EVENT	Reserved	OC_BUCK_EVENT	OV_BUCK_EVENT	UV_BUCK_EVENT	Reserved	Reserved		

## High Efficiency, Ultra-Low Quiescent Current and Ultra-Low Output Ripple Buck Regulator

Field Name	Bits	Type	POR	Description
VIN_UV_EVENT	[6]	evnt	0x0	Under Voltage on VDD event flag. When Under Voltage (UVLO) condition is detected, this bit is set to 1. When I2C writes '1' to this bit, the event flag is cleared.
OC_BUCK_EVENT	[4]	evnt	0x0	Over Current on BUCK OUT event flag. When the buck Over Current condition is detected (when BUCK_EN==1 && M_OC_BUCK==0), this bit is set to 1. When I2C writes '1' to this bit, the event flag is cleared.
OV_BUCK_EVENT	[3]	evnt	0x0	Over Voltage on BUCK OUT event flag. When the buck Over Voltage condition is detected (when BUCK_EN==1 && M_OV_BUCK==0), this bit is set to 1. When I2C writes '1' to this bit, the event flag is cleared.
UV_BUCK_EVENT	[2]	evnt	0x0	Under voltage on BUCK OUT event flag. When the under voltage condition (i.e. short circuit) is detected on the buck (when BUCK_EN==1 && M_UV_BUCK==0), this bit is set to 1. When I2C writes '1' to this bit, this event flag is cleared.

**Table 16: Register STATUS**

Address	Register Name	POR Value	Status				
0x0002	STATUS	0x00					
<b>7</b>	<b>6</b>	<b>5</b>	<b>4</b>	<b>3</b>	<b>2</b>	<b>1</b>	<b>0</b>
Reserved	VIN_UV_STAT	Reserved	OC_BUCK_STAT	OV_BUCK_STAT	UV_BUCK_STAT	Reserved	BUCK_EN_STAT
Field Name	Bits	Type	POR	Description			
VIN_UV_STAT	[6]	virtual	0x0	Indicate present V <sub>IN</sub> under-voltage status.			
OC_BUCK_STAT	[4]	virtual	0x0	Indicate present BUCK VOUT over current status.			
OV_BUCK_STAT	[3]	virtual	0x0	Indicate present BUCK VOUT over voltage status.			

## High Efficiency, Ultra-Low Quiescent Current and Ultra-Low Output Ripple Buck Regulator

Field Name	Bits	Type	POR	Description
UV_BUCK_STAT	[2]	virtual	0x0	Indicate present BUCK VOUT under voltage status.
BUCK_EN_STAT	[0]	virtual	0x0	Indicate present Buck Enable status. 1:Buck enabled 0:Buck disabled

**Table 17: Register MASK**

Address	Register Name	POR Value	Mask				
0x0003	MASK	0x7C					
<b>7</b>	<b>6</b>	<b>5</b>	<b>4</b>	<b>3</b>	<b>2</b>	<b>1</b>	<b>0</b>
Reserved	M_VIN_UV	Reserved	M_OC_BUCK_EVENT	M_OV_BUCK_EVENT	M_UV_BUCK_EVENT	Reserved	Reserved
Field Name	Bits	Type	POR	Description			
M_VIN_UV	[6]	cfg OTP	0x1	Mask to set VIN_UV_EVNT. VIN_UV_STAT is updated regardless of this mask.			
M_OC_BUCK_EVENT	[4]	cfg OTP	0x1	Masks to set OC_BUCK_EVENT. OC_BUCK_STAT is updated regardless of this mask.			
M_OV_BUCK_EVENT	[3]	cfg OTP	0x1	Masks to set OV_BUCK_EVENT. OV_BUCK_STAT is updated regardless of this mask.			
M_UV_BUCK_EVENT	[2]	cfg OTP	0x1	Masks to set UV_BUCK_EVENT. UV_BUCK_STAT is updated regardless of this mask.			

## High Efficiency, Ultra-Low Quiescent Current and Ultra-Low Output Ripple Buck Regulator

### 11.2.1.2 User Registers

**Table 18: Register GPO**

Address	Register Name	POR Value	GPO control				
0x0004	GPO	0x00					
7	6	5	4	3	2	1	0
GPO_RST_CTRL<3:0>				GPO_CTRL<3:0>			
Field Name	Bits	Type	POR	Description			
GPO_RST_CTRL	[7:4]	cfg OTP	0x0	Reset pulse signal nagate timing control			
				<b>Value</b>	<b>Description</b>		
				0x0	8ms after BUCK_EN = 1, GPO reset pulse is negated.		
				0x1	16ms after BUCK_EN = 1, GPO reset pulse is negated.		
				0x2	32ms after BUCK_EN = 1, GPO reset pulse is negated.		
				0x3	48ms after BUCK_EN = 1, GPO reset pulse is negated.		
				0x4	64ms after BUCK_EN = 1, GPO reset pulse is negated.		
				0x5	80ms after BUCK_EN = 1, GPO reset pulse is negated.		
				0x6	96ms after BUCK_EN = 1, GPO reset pulse is negated.		
0x7	112ms after BUCK_EN = 1, GPO reset pulse is negated.						
GPO_CTRL	[3:0]	cfg OTP	0x0	GPO Control			
				<b>Value</b>	<b>Description</b>		

## High Efficiency, Ultra-Low Quiescent Current and Ultra-Low Output Ripple Buck Regulator

Field Name	Bits	Type	POR	Description
				0x1 Reset Pulse generation output
				0x2 PowerGood indicator, Active Low
				0x3 PowerGood indicator, Active High
				0x4 Event indicator
				0x8 Force GPO output low
				0x9 Force GPO output hi-z

**Table 19: Register BUCK**

Address	Register Name	POR Value	Buck enable & vout control				
0x0005	BUCK	0x58					
<b>7</b>	<b>6</b>	<b>5</b>	<b>4</b>	<b>3</b>	<b>2</b>	<b>1</b>	<b>0</b>
BUCK_EN	VOUT_RANGE_HI	Reserved	BUCK_VOUT<4:0>				
Field Name	Bits	Type	POR	Description			
BUCK_EN	[7]	cfg OTP	0x0	BUCK enable			
VOUT_RANGE_HI	[6]	cfg OTP	0x1	Range selection for buck. This can only be changed while BUCK_EN = 0			
				Value	Description		
				0x0	0.60 V <= VBUCK <= 1.30 V		
				0x1	1.30 V <= VBUCK <= 1.90 V		

## High Efficiency, Ultra-Low Quiescent Current and Ultra-Low Output Ripple Buck Regulator

Field Name	Bits	Type	POR	Description	
BUCK_VOUT	[4:0]	datablk OTP	0x18	Buck output voltage	
				<b>Value</b>	<b>Description</b>
				0x00	0.60 V
				0x01	0.65 V
				0x02	0.70 V
				0x03	0.75 V
				0x04	0.80 V
				0x05	0.85 V
				0x06	0.90 V
				0x07	0.95 V
				0x08	1.00 V
				0x09	1.05 V
				0x0A	1.10 V
				0x0B	1.15 V
0x0C	1.20 V				
0x0D	1.25 V				
0x0E	1.30 V				
0x0F	1.35 V				
0x10	1.40 V				

## High Efficiency, Ultra-Low Quiescent Current and Ultra-Low Output Ripple Buck Regulator

Field Name	Bits	Type	POR	Description
				0x11 1.45 V
				0x12 1.50 V
				0x13 1.55 V
				0x14 1.60 V
				0x15 1.65 V
				0x16 1.70 V
				0x17 1.75 V
				0x18 1.80 V
				0x19 1.85 V
				0x1A 1.90 V
				0x1B 1.90 V
				0x1C 1.90 V
				0x1D 1.90 V
				0x1E 1.90 V
				0x1F 1.90 V

**Table 20: Register BUCK\_CFG**

Address	Register Name	POR Value	
0x0006	BUCK_CFG	0x00	Buck config



## High Efficiency, Ultra-Low Quiescent Current and Ultra-Low Output Ripple Buck Regulator

7	6	5	4	3	2	1	0
Reserved	Reserved	BUCK_PD_CFG2	BUCK_PD_CFG1	Reserved	Reserved	SEL_BUCK_ILIM<1:0>	
Field Name	Bits	Type	POR	Description			
BUCK_PD_CFG2	[5]	cfg OTP	0x0	0: If BUCK_EN = 0, BUCK_PD_EN = 1 1: If BUCK_EN = 0, BUCK_PD_EN = 0			
BUCK_PD_CFG1	[4]	cfg OTP	0x0	0: When BUCK is forced off by faults, BUCK_PD_EN = 1 1: When BUCK is forced off by faults, BUCK_PD_EN = 0			
SEL_BUCK_ILIM	[1:0]	cfg OTP	0x0	Buck peak current limit setting			
				Value	Description		
				0x0	Default current limit		
				0x1	Default +50 mA		
				0x2	Default +100 mA		
0x3	Default +150 mA						

**Table 21: Register FAUL\_CTL**

Address	Register Name	POR Value	Fault & Recovery control				
0x0008	FAUL_CTL	0x1F					
7	6	5	4	3	2	1	0
SC_DIS_BUCK	OC_DIS_BUCK	OV_DIS_BUCK	TSD_FRC_DIS	UVLO_FRC_DIS	RCVRY_NUM<2:0>		
Field Name	Bits	Type	POR	Description			
SC_DIS_BUCK	[7]	cfg OTP	0x0	1: Force disable BUCK during SHORT CIRCUIT condition oc_buck=1 & uv_buck=1			

## High Efficiency, Ultra-Low Quiescent Current and Ultra-Low Output Ripple Buck Regulator

Field Name	Bits	Type	POR	Description
OC_DIS_BUCK	[6]	cfg OTP	0x0	1: Force disable BUCK during oc_buck=1 for over 64 cycles
OV_DIS_BUCK	[5]	cfg OTP	0x0	1: Force disable BUCK during ov_buck=1
TSD_FRC_DIS	[4]	cfg OTP	0x1	1: Force disable BUCK during Over Temp
UVLO_FRC_DIS	[3]	cfg OTP	0x1	1: Force disable BUCK during UVLO
RCVRY_NUM	[2:0]	data OTP	0x7	BUCK recovery trial fault number. This is counted down by every fault forcing BUCK off. If RCVRY_NUM becomes 0, Recovery trial is ended. If RCVRY_NUM is set 0x7, this is not counted down and recovery trail is not ended.

**Table 22: Register PIN\_MONITOR**

Address	Register Name	POR Value	PIN MONITOR				
0x000A	PIN_MONTOR	0x00					
<b>7</b>	<b>6</b>	<b>5</b>	<b>4</b>	<b>3</b>	<b>2</b>	<b>1</b>	<b>0</b>
Reserved	Reserved	Reserved	Reserved	Reserved	Reserved	Reserved	GPO_OUT_MON
Field Name	Bits	Type	POR	Description			
GPO_OUT_MON	[0]	virtual	0x0	Indicate current GPO output			

## High Efficiency, Ultra-Low Quiescent Current and Ultra-Low Output Ripple Buck Regulator

### 11.2.2 System Module

#### 11.2.2.1 System Reset Registers

**Table 23: Register SYS\_RST\_EVENT**

Address	Register Name	POR Value	Reset Event flag				
0x0001	SYS_RST_EVENT	0x01					
7	6	5	4	3	2	1	0
Reserved	Reserved	Reserved	Reserved	Reserved	Reserved	Reserved	RESET_EVENT
Field Name	Bits	Type	POR	Description			
RESET_EVENT	[0]	evnt	0x1	RESET event flag. After Reset, this bit is set. When I2C write '1' to this bit, this event flag is cleared.			

**Table 24: Register SYS\_SRST**

Address	Register Name	POR Value	Soft Reset				
0x0009	SYS_SRST	0x00					
7	6	5	4	3	2	1	0
Reserved	Reserved	Reserved	Reserved	SRST<3:0>			
Field Name	Bits	Type	POR	Description			
SRST	[3:0]	cfg	0x0	Initiate Soft Reset by writing 0x5.			

## High Efficiency, Ultra-Low Quiescent Current and Ultra-Low Output Ripple Buck Regulator

### 11.2.2.2 System ID Registers

**Table 25: Register SYS\_DEVICE\_ID**

Address	Register Name	POR Value	DEVICE_ID				
0x0080	SYS_DEVICE_ID	0x00					
7	6	5	4	3	2	1	0
DEV_ID<7:0>							
Field Name	Bits	Type	POR	Description			
DEV_ID	[7:0]	virtual	0x0	Device ID; hard-coded or metal-programmed			

**Table 26: Register SYS\_VARIANT\_ID**

Address	Register Name	POR Value	VARIANT_ID				
0x0081	SYS_VARIANT_ID	0x00					
7	6	5	4	3	2	1	0
MRC<3:0>				VRC<3:0>			
Field Name	Bits	Type	POR	Description			
MRC	[7:4]	virtual	0x0	Mask Revision Code; mask design changes increment reset value.			
VRC	[3:0]	trim OTP	0x0	Chip Variant Code; e.g. package variants.			

## High Efficiency, Ultra-Low Quiescent Current and Ultra-Low Output Ripple Buck Regulator

Table 27: Register SYS\_CONFIG\_ID

Address	Register Name	POR Value	CONFIG_ID				
0x0082	SYS_CONFIG_ID	0x00					
7	6	5	4	3	2	1	0
CONFIG_REV<7:0>							
Field Name	Bits	Type	POR	Description			
CONFIG_REV	[7:0]	trim OTP	0x0	OTP settings revision			

High Efficiency, Ultra-Low Quiescent Current and Ultra-Low Output Ripple Buck Regulator

12 Package Information

12.1 Package Outlines

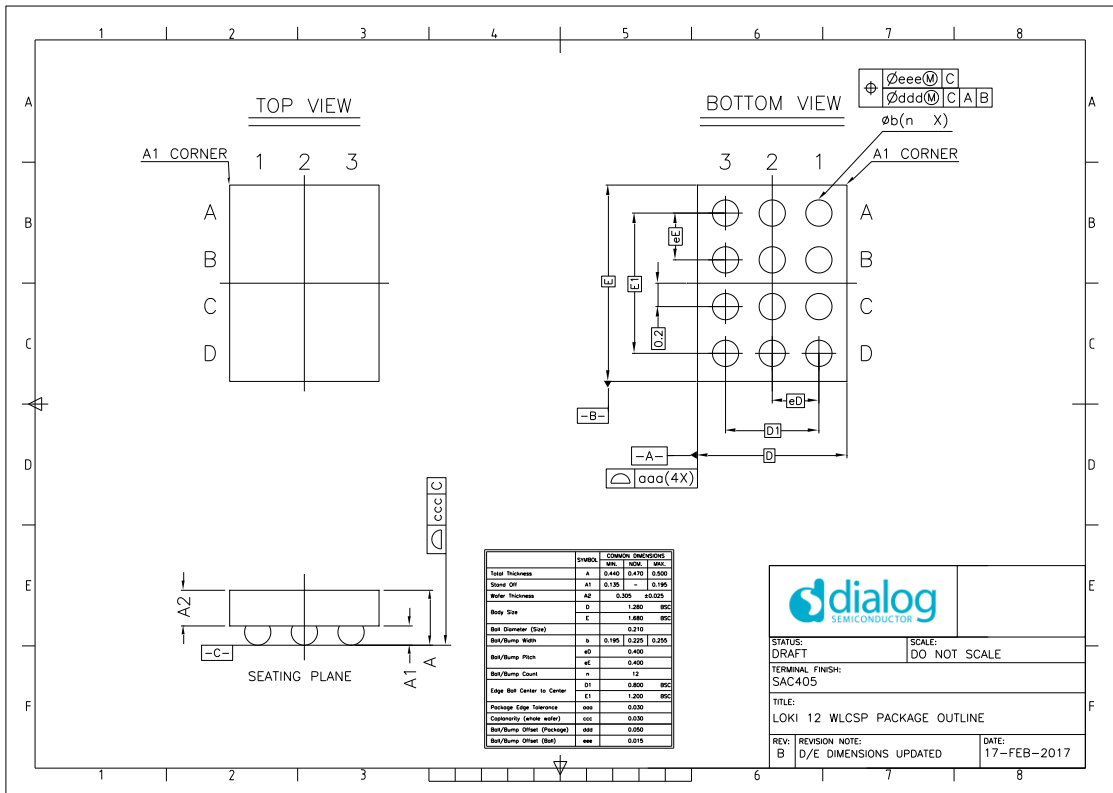

Figure 38: Package Outline Drawing

---

## High Efficiency, Ultra-Low Quiescent Current and Ultra-Low Output Ripple Buck Regulator

### 12.2 Moisture Sensitivity Level

The Moisture Sensitivity Level (MSL) is an indicator for the maximum allowable time period (floor lifetime) in which a moisture sensitive plastic device, once removed from the dry bag, can be exposed to an environment with a maximum temperature of 30 °C and a maximum relative humidity of 60% RH before the solder reflow process. The MSL classification is defined in [Table 28](#).

The device package is qualified for MSL 1.

**Table 28: MSL Classification**

MSL level	Floor Lifetime
MSL 1	unlimited at 30 °C/85 % RH

### 12.3 Soldering Information

Refer to the JEDEC standard J-STD-020 for relevant soldering information. This document can be downloaded from <http://www.jedec.org>.

## High Efficiency, Ultra-Low Quiescent Current and Ultra-Low Output Ripple Buck Regulator

### 13 Ordering Information

The ordering number consists of the part number followed by a suffix indicating the packing method. For details and availability or other custom OTP parts, please consult your Renesas Electronics [local sales representative](#).

**Table 29: Ordering Information**

Part number	Package	Size (mm)	Shipment Form	Pack Quantity
DA9232 -xxxx	WLCSP-12	1.25 x 1.65	T&R	4500

**Table 30: OTP List**

Order code	Description	Buck V <sub>out</sub>
DA9232-81VZ2	OTP with buck voltage preconfigured	1.8 V
DA9232-82VZ2	OTP with buck voltage preconfigured	0.7 V



## High Efficiency, Ultra-Low Quiescent Current and Ultra-Low Output Ripple Buck Regulator

### Status Definitions

Revision	Datasheet Status	Product Status	Definition
1.<n>	Target	Development	This datasheet contains the design specifications for product development. Specifications may be changed in any manner without notice.
2.<n>	Preliminary	Qualification	This datasheet contains the specifications and preliminary characterization data for products in pre-production. Specifications may be changed at any time without notice in order to improve the design.
3.<n>	Final	Production	This datasheet contains the final specifications for products in volume production. The specifications may be changed at any time in order to improve the design, manufacturing and supply. Relevant changes will be communicated via Customer Product Notifications.
4.<n>	Obsolete	Archived	This datasheet contains the specifications for discontinued products. The information is provided for reference only.

### RoHS Compliance

Renesas Electronics' suppliers certify that its products are in compliance with the requirements of Directive 2011/65/EU of the European Parliament on the restriction of the use of certain hazardous substances in electrical and electronic equipment. RoHS certificates from our suppliers are available on request.

---

## High Efficiency, Ultra-Low Quiescent Current and Ultra-Low Output Ripple Buck Regulator

### Important Notice and Disclaimer

RENEASAS ELECTRONICS CORPORATION AND ITS SUBSIDIARIES (“RENEASAS”) PROVIDES TECHNICAL SPECIFICATIONS AND RELIABILITY DATA (INCLUDING DATASHEETS), DESIGN RESOURCES (INCLUDING REFERENCE DESIGNS), APPLICATION OR OTHER DESIGN ADVICE, WEB TOOLS, SAFETY INFORMATION, AND OTHER RESOURCES “AS IS” AND WITH ALL FAULTS, AND DISCLAIMS ALL WARRANTIES, EXPRESS OR IMPLIED, INCLUDING, WITHOUT LIMITATION, ANY IMPLIED WARRANTIES OF MERCHANTABILITY, FITNESS FOR A PARTICULAR PURPOSE, OR NON-INFRINGEMENT OF THIRD PARTY INTELLECTUAL PROPERTY RIGHTS.

(Rev.1.0 Mar 2020)

## Corporate Headquarters

TOYOSU FORESIA, 3-2-24 Toyosu

Koto-ku, Tokyo 135-0061, Japan

[www.renesas.com](http://www.renesas.com)

### Contact Information

For further information on a product, technology, the most up-to-date version of a document, or your nearest sales office, please visit:

<https://www.renesas.com/contact/>

### Trademarks

Renesas and the Renesas logo are trademarks of Renesas Electronics Corporation. All trademarks and registered trademarks are the property of their respective owners.