

HS40xx

High-Performance Relative Humidity and Temperature Sensor with Digital Output

The HS40xx series is a highly accurate, fully calibrated automotive-grade relative humidity and temperature sensor. While the HS400x devices come in a standard package with open air inlet, the HS401x devices feature a hydrophobic membrane, making it dust resistant and waterproof with IP67 rating. Both sensor versions, waterproof and non-waterproof, are available in two different accuracy classes, HS40x1 and HS40x3. The MEMS sensor features a proprietary sensor-level protection, ensuring high reliability and long-term stability.

Integrated calibration using a NIST traceable and verified production setup that is calibrated to ISO/IEC 17025 standards and temperature-compensation logic provides fully corrected RH and temperature values via a standard I²C output. No user calibration of the output data is required.

The high accuracy, fast measurement response time, and long-term stability combined with the small package size makes the HS40xx series ideal for a wide number of applications ranging from portable devices to products designed for harsh environments.

The HS40xx series digital sensor accurately measures relative humidity and temperature levels. The measured data is internally corrected and compensated for accurate operation over a wide range of temperature and humidity levels – user calibration is not required.

The ultra-low power consumption, micro-Watt, makes the HS40xx the ideal choice for portable and remote applications.

Physical Characteristics

- Supply voltage: 1.71V to 3.6V
- Operating temperature: -40°C to +125°C
- 2.50 × 2.50 × 0.90 mm DFN-style 8-LGA package

Product Image



Features

- Humidity range: 0% to 100%RH
- Industrial grade, JEDEC qualified, -40°C to +125°C
- Automotive grade, AEC-Q100 qualified, Grade 2, -40°C to +105°C
- NIST traceability for relative humidity and temperature
- Hydrophobic membrane, IP67 rating (HS401x)
- Digital I²C output with CRC checksum
- RH accuracy: ±1.5%RH, typical (HS40x1)
- Temperature accuracy: ±0.2°C, typical (HS40x1, -10°C to +80°C)
- 14-bit resolution: 0.04%RH, typical
- Independent programmable resolution settings: 8, 10, 12, 14 bits
- Fast RH response time: 4 seconds time constant, typical
- Very low current consumption: 0.3μA average (8-bit resolution, 3.3V supply), 0.62μA average (14-bit resolution, 3.3V supply), one RH and temperature measurement per second
- Excellent stability against aging and volatile compounds
- Highly robust protection from harsh environmental conditions and mechanical shock

Applications

- Climate control systems
- Instrumentation
- Home appliances
- Weather stations
- Building automation
- HVAC systems
- Medical equipment
- Data logging systems

Contents

1. Pin Information	4
1.1 Pin Assignments	4
1.2 Pin Descriptions	4
1.3 Functional Diagram	4
2. Specifications	5
2.1 Absolute Maximum Ratings	5
2.2 Recommended Operating Conditions	5
3. Humidity and Temperature Sensor Performance	6
3.1 Humidity Sensor Specification	6
3.2 Temperature Sensor Specification	6
3.3 Humidity Sensor Accuracy Graphs	7
3.4 Temperature and Sensor Accuracy Graphs	7
4. Conditioning	8
5. PCB Layout Guidelines	8
6. Application Circuit	9
7. Sensor Interface	9
7.1 I ² C Features and Timing	9
7.2 Sensor Slave Address	10
7.3 I ² C Communication	10
7.4 Measurements and Commands	11
7.4.1 Performing a Hold Measurement	12
7.4.2 Performing a No-Hold Measurement	12
7.4.3 Calculating Humidity and Temperature Output	13
7.4.4 Measurement Conversion Times	14
7.4.5 CRC Checksum Calculation	14
7.5 Periodic Measurement Mode	15
7.6 Alert Feature	15
7.6.1 Alert Pin – Measurement Active	16
7.6.2 Alert Pin – Humidity and Temperature Threshold Detection	16
7.7 Accessing Configurable HS40xx Registers	18
7.7.1 Read Register Command	19
7.7.2 Write Register Command	19
7.8 Configuration Bits	20
7.8.1 Setting the Measurement Resolution	20
7.8.2 Periodic Measurement Settings	20
7.9 Reading the Sensor ID Number	22
7.10 Resetting the Sensor	23
8. Soldering Information	24
9. Storage and Handling	25
10. Quality and Reliability	25
11. Package Outline Drawings	25

12. Marking Diagram	25
13. Ordering Information	25
14. Revision History	26

Figures

Figure 1. Pin Assignments – Top View.....	4
Figure 2. Functional Diagram of HS40xx.....	4
Figure 3. HS40x1 RH Accuracy Tolerance at 25°C.....	7
Figure 4. HS40x1 RH Accuracy over Temperature	7
Figure 5. HS40x3 RH Accuracy Tolerance at 25°C.....	7
Figure 6. HS40x3 RH Accuracy over Temperature	7
Figure 7. HS40x3 Temperature Sensor Accuracy Tolerance	7
Figure 8. HS40x1 Temperature Sensor Accuracy Tolerance	7
Figure 9. Milled PCB Openings for Thermal Isolation.....	8
Figure 10. HS40xx Application Circuit – Top View	9
Figure 11. Timing Diagram.....	9
Figure 12. START and STOP Condition Waveform.....	10
Figure 13. Typical Hold Measurement Sequence for a Humidity and Temperature Command.....	12
Figure 14. Typical No-Hold Measurement Sequence for a Humidity and Temperature Command	13
Figure 15. Sequence to Retrieve the Latest Results in Periodic Measurement Mode.....	15
Figure 16. Sequence to Stop Periodic Measurements	15
Figure 17. Alert Pin Function.....	16
Figure 18. Alert Pin Functionality Example.....	17
Figure 19. Data Returned from HS40xx when the Alert Feature is Enabled in Periodic Measurement Mode	17
Figure 20. Read Register Command Sequence	19
Figure 21. Write Register Command Sequence	19
Figure 22. Read Sensor ID Command Sequence	23
Figure 23. Recommended Soldering Profile.....	24

Tables

Table 1. Absolute Maximum Ratings for HS40xx Sensors	5
Table 2. Operating Conditions for HS40xx Sensors	5
Table 3. Humidity Sensor Specification, $T_A = +25^{\circ}\text{C}$, $V_{DD} = 1.71\text{V}$ to 3.6V	6
Table 4. Temperature Sensor Specification, $T_A = +25^{\circ}\text{C}$, $V_{DD} = 1.71\text{V}$ to 3.6V	6
Table 5. I ² C Timing Parameters	10
Table 6. Commands Code and Description.....	11
Table 7. Measurement Command Modes	11
Table 8. Conversion Times.....	14
Table 9. CRC Checksum Properties.....	14
Table 10. Alert Status Bits.....	18
Table 11. Temperature and Humidity Measurement Resolution Settings.....	20
Table 12. Periodic Measurement Settings.....	20
Table 13. Alert Feature Settings.....	21

1. Pin Information

1.1 Pin Assignments

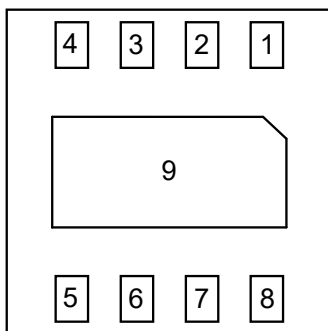

Figure 1. Pin Assignments – Top View

1.2 Pin Descriptions

Pin Number	Pin Name	Type	Description
1	SDA	In/Out	Serial data.
2	NC ^[1]	-	Connect to V _{SS} , V _{DD} or leave floating
3	ALERT	Out	Digital output indicating an alarm condition. Leave floating if unused.
4	SCL	In/Out	Serial clock.
5	VDD	In	Supply voltage.
6	NC ^[1]	-	Connect to V _{SS} , V _{DD} or leave floating.
7	NC ^[1]	-	Connect to V _{SS} , V _{DD} , or leave floating.
8	VSS	In	Ground.
9	DAP	-	Connect to V _{SS} or leave floating.

1. "NC" stands for not connected.

1.3 Functional Diagram

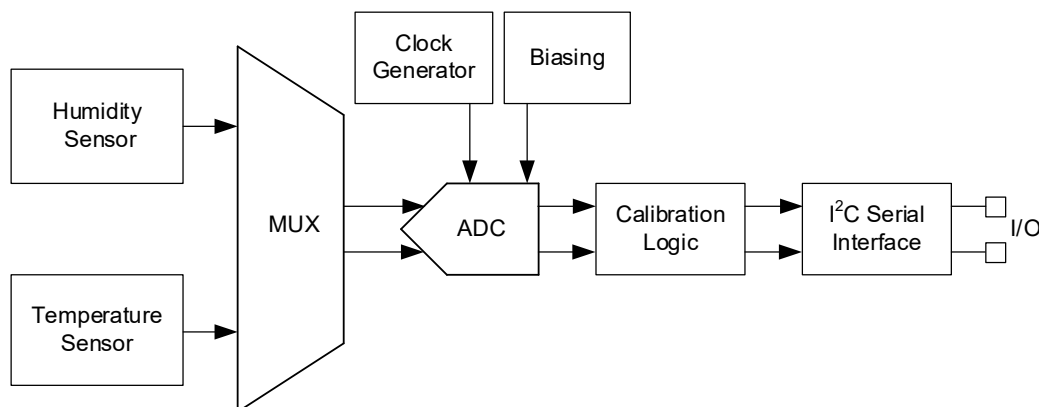

Figure 2. Functional Diagram of HS40xx

2. Specifications

2.1 Absolute Maximum Ratings

Caution: The absolute maximum ratings are stress ratings only. Stresses greater than those listed below can cause permanent damage to the device. Functional operation of the HS40xx at absolute maximum ratings is not implied. Exposure to absolute maximum rating conditions might affect device reliability.

Table 1. Absolute Maximum Ratings for HS40xx Sensors

Parameter	Conditions	Minimum	Maximum	Unit
Supply Voltage	-	-0.3	3.6	V
Storage Temperature Range	Recommended 0 to 60°C	-40	125	°C

2.2 Recommended Operating Conditions

Important: The HS40xx series sensors are optimized to perform best in the more common temperature and humidity ranges of 10°C to 50°C and 20% RH to 80% RH, respectively. If operated outside of these conditions for extended periods, especially at high humidity levels, the sensors may exhibit an offset. In most cases, this offset is temporary and will gradually disappear once the sensor is returned to normal temperature and humidity conditions. The amount of the shift and the duration of the offset vary depending on the duration of exposure and the severity of the relative humidity and temperature conditions ^[1]. The time needed for the offset to disappear can also be decreased by using the procedures described in section 4.

Table 2. Operating Conditions for HS40xx Sensors

Parameter	Condition	Minimum	Typical	Maximum	Unit	
Operating Supply Voltage	-	1.71	3.3	3.6	V	
Sleep Current	Sleep Mode	25°C	-	0.010	0.025	µA
		-40 to 125°C	-	-	2.5	
Average Current	One RH + temperature measurement/second V _{DD} = 3.3V	8-bit resolution	0.27	0.30	0.32	µA
		10-bit resolution	0.31	0.34	0.37	
		12-bit resolution	0.39	0.43	0.47	
		14-bit resolution	0.55	0.62	0.69	
Measurement Time	Humidity and temperature including the digital compensation	8-bit resolution	-	0.64	-	ms
		10-bit resolution	-	0.80	-	
		12-bit resolution	-	1.04	-	
		14-bit resolution	-	1.70	-	
Operating Temperature Range	-	-40	-	125	°C	
Logic Voltage Level High	Applies for SDA and SCL	0.7 * V _{DD}	-	-	V	
Logic Voltage Level Low	Applies for SDA and SCL	-	-	0.3 * V _{DD}	V	

1. At T_A = +25°C, V_{DD} = +1.71V to +3.6V unless otherwise specified.

3. Humidity and Temperature Sensor Performance

3.1 Humidity Sensor Specification

Table 3. Humidity Sensor Specification, T_A = +25°C, V_{DD} = 1.71V to 3.6V

Parameter	Condition		Minimum	Typical	Maximum	Unit
Range	-		0	-	100	%RH
Accuracy ^{[1][2]}	HS40x1	10% to 90%RH	-	±1.5	-	%RH
	HS40x3	20% to 80%RH	-	±2.5	-	
Resolution	14-bit		-	0.04	-	%RH
Hysteresis	-		-	-	±1.0	%RH
Non-Linearity from Response Curve	HS40x1	10% to 90%RH	-	±0.15	-	%RH
	HS40x3	20% to 80%RH				
Long-Term Stability	-		-	±0.1	-	%RH/Yr
Response Time Constant ^[3] (τ _H)	20% to 80% RH Still Air		3.0	4.0	6.0	sec

1. Monotonic increases from 10% to 90% RH after sensor has been stabilized at 50% RH.
2. For more information, see section 3.3.
3. Initial value to 63% of total variation. Response time depend on system airflow.

3.2 Temperature Sensor Specification

Table 4. Temperature Sensor Specification, T_A = +25°C, V_{DD} = 1.71V to 3.6V

Parameter	Condition		Minimum	Typical	Maximum	Unit
Range	-		-40	-	125	°C
Accuracy ^[1]	HS40x1	-10°C to 80°C	-	±0.2	-	°C
	HS40x3	0°C to 70°C	-	±0.25	-	
Resolution	14-bit		-	0.01	-	°C
Response Time Constant ^[2] (τ _T)	-		-	>2.0	-	Sec.
Long-Term Stability	-		-	-	0.03	°C/Yr
Supply Voltage Dependency ^[3]	-		-	0.03	0.1	°C/V

1. For more information, see section 3.4.
2. Initial value to 63% of total variation. Response time depends on system thermal mass and air flow.
3. Temperature accuracy can be optimized for specified supply voltages upon request.

3.3 Humidity Sensor Accuracy Graphs

The typical relative humidity sensor accuracy tolerances are shown in the following figures.

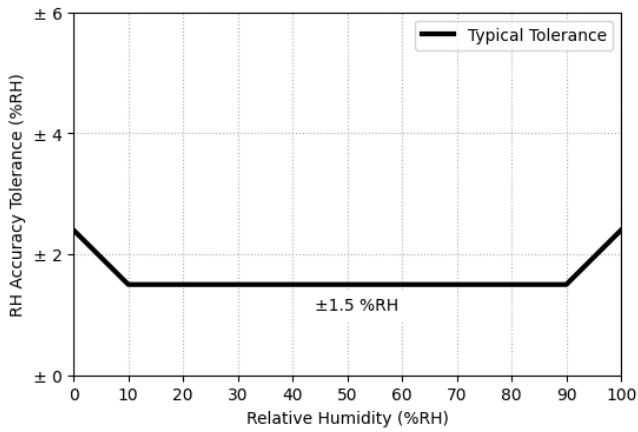

Figure 3. HS40x1 RH Accuracy Tolerance at 25°C

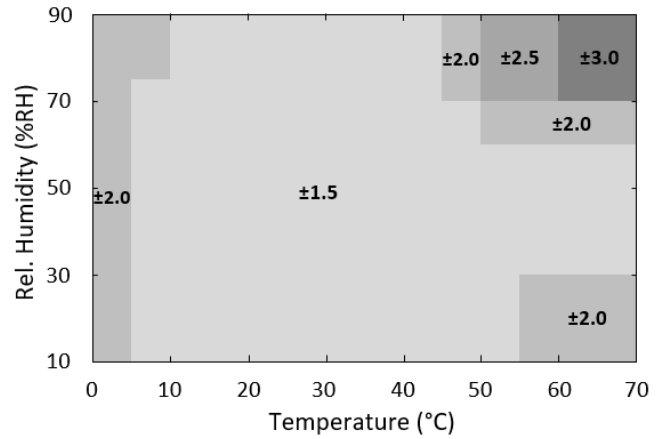

Figure 4. HS40x1 RH Accuracy over Temperature

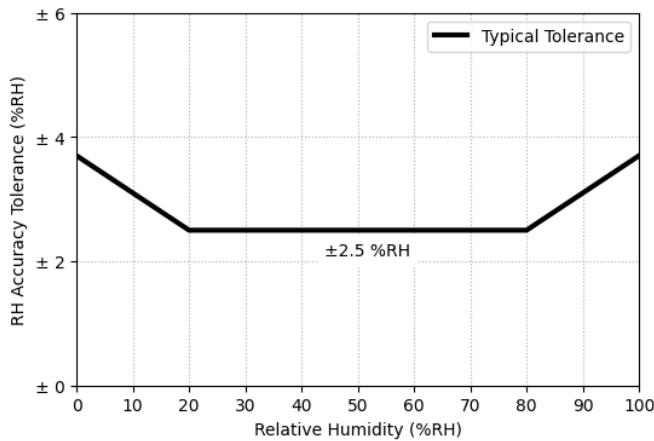

Figure 5. HS40x3 RH Accuracy Tolerance at 25°C

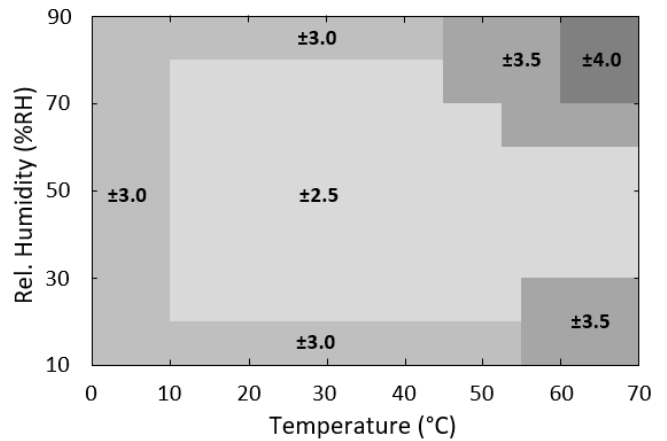

Figure 6. HS40x3 RH Accuracy over Temperature

3.4 Temperature and Sensor Accuracy Graphs

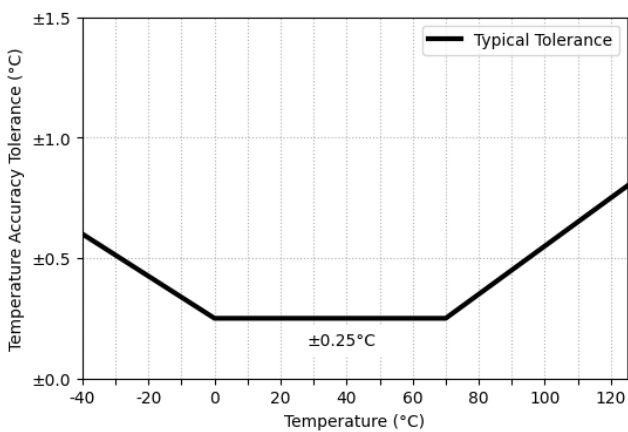

Figure 7. HS40x3 Temperature Sensor Accuracy Tolerance

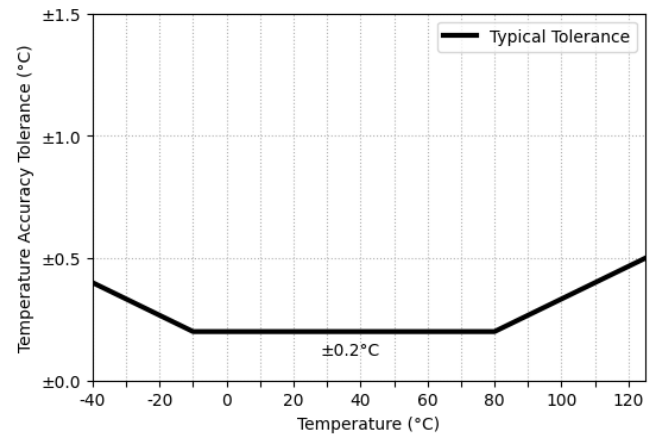

Figure 8. HS40x1 Temperature Sensor Accuracy Tolerance

4. Conditioning

After soldering or prolonged storage outside the nominal storage conditions, a conditioning routine must be applied to ensure high sensor accuracy. Not following this routine will result in a slowly disappearing offset in the relative humidity readings. When a relative humidity sensor is exposed to the high heat associated with the soldering process, the sensor element tends to dry out. To avoid an offset in the relative humidity readings, the sensor element must be rehydrated after the soldering process.

Recommended rehydration process:

- A relative humidity of 75% RH at room temperature for at least 12 hours, or
- A relative humidity of 40% to 50% RH at room temperature for 3 to 5 days

To avoid relative humidity reading offset after prolonged storage outside the *recommended storage conditions*, use the following procedure to recondition the humidity sensor.

1. Bake at a temperature of 100°C with a humidity < 10% RH for 10 to 12 hours.
2. Rehydrate the sensor at a humidity of 75% RH and a temperature between 20°C to 30°C for 12 to 14 hours.

5. PCB Layout Guidelines

When designing the PCB, undesired heat transfer paths to the HS40xx series must be minimized. Excessive heat from other components on the PCB will result in inaccurate temperature and relative humidity measurements. As such, **solid metal planes for power supplies should be avoided in the vicinity of the sensor** since these will act as thermal conductors. To further reduce the heat transfer from other components on the board, openings can be milled into the PCB as shown in Figure 9.

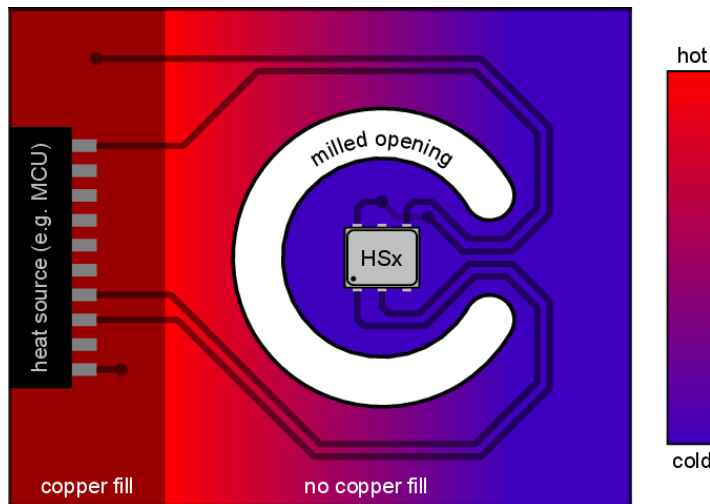

Figure 9. Milled PCB Openings for Thermal Isolation

6. Application Circuit

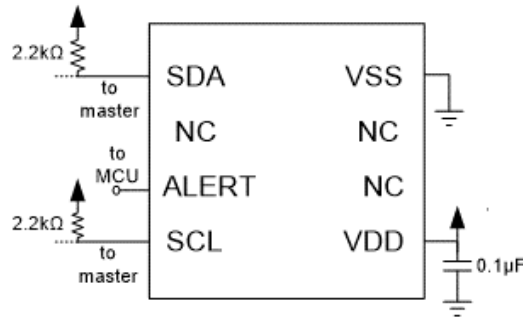

Figure 10. HS40xx Application Circuit – Top View

7. Sensor Interface

The HS40xx series sensor uses a digital I²C-compatible communication protocol. To accommodate multiple devices, the protocol uses two bi-directional open-drain lines: the Serial Data Line (SDA) and the Serial Clock Line (SCL). Pull-up resistors to V_{DD} are required. Several slave devices can share the bus; however, only one master device can be present on the line.

7.1 I²C Features and Timing

The HS40xx series sensor operates as a slave device on the I²C bus with support for 100kHz and 400kHz bit rates. Each transmission is initiated when the master sends a 0 START bit (S), and the transmission is terminated when the master sends a 1 STOP bit (P). These bits are exclusively transmitted while the SCL line is high.

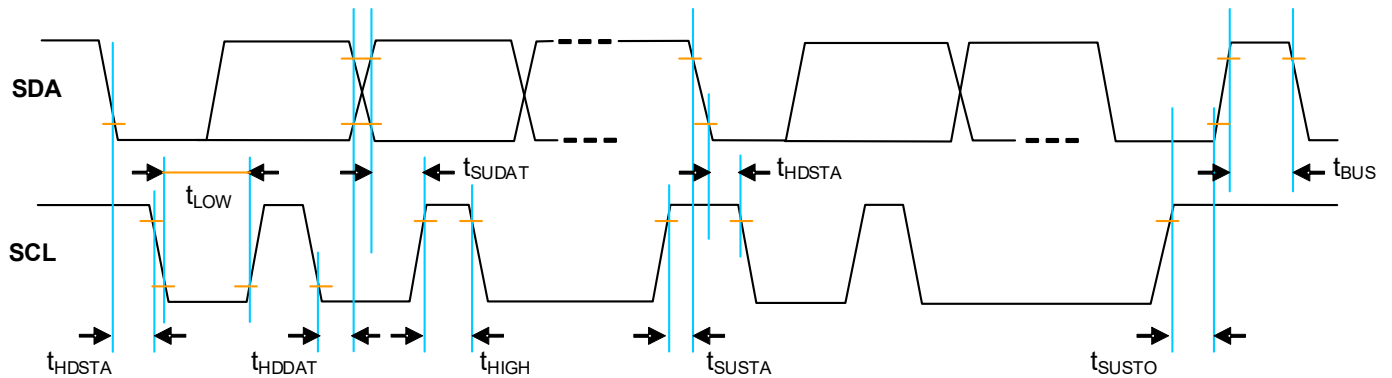

Figure 11. Timing Diagram

Table 5. I²C Timing Parameters

Parameter	Symbol	Minimum	Typical	Maximum	Unit
SCL Clock Frequency	f _{SCL}	0	-	400	kHz
START Condition Hold Time Relative to SCL Edge	t _{HDSTA}	0.1	-	-	μs
Minimum SCL Clock LOW Width ^[1]	t _{LOW}	0.6	-	-	μs
Minimum SCL Clock HIGH Width ^[1]	t _{HIGH}	0.6	-	-	μs
START Condition Setup Time Relative to SCL Edge	t _{SUSTA}	0.1	-	-	μs
Data Hold Time on SDA Relative to SCL Edge	t _{HDDAT}	0	-	0.5	μs
Data Setup Time on SDA Relative to SCL Edge	t _{SUDAT}	0.1	-	-	μs
STOP Condition Setup Time on SCL	t _{SUSTO}	0.1	-	-	μs
Bus Free Time Between STOP Condition and START Condition	t _{BUS}	1	-	-	μs

1. Combined LOW and HIGH widths must equal or exceed the minimum SCL period.

7.2 Sensor Slave Address

The HS40xx series default I²C address is 54_{HEX}. The device will respond only to this 7-bit address.

7.3 I²C Communication

The sensor transmission is initiated when the master sends a 0 START bit (S). The transmission is terminated when the master sends a 1 STOP bit (P). These bits are only transmitted while the SCL line is HIGH (see Figure 12 for waveforms).

Once the START condition has been set, the SCL line is toggled at the prescribed data rate, clocking subsequent data transfers. Data on the SDA line is always sampled on the rising edge of the SCL line and must remain stable while SCL is HIGH to prevent false START or STOP conditions.

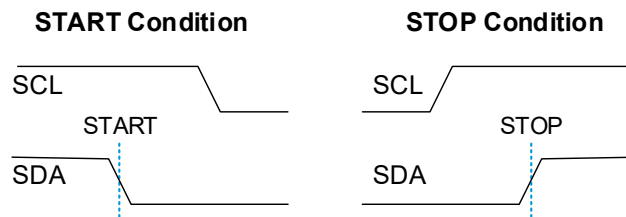

Figure 12. START and STOP Condition Waveform

After the START bit, the master device sends the 7-bit slave address (see section 7.2) to the HS40xx, followed by the read/write bit, which indicates the transfer direction of any subsequent data. This bit is set to 1 to indicate a read from slave to master or set to 0 to indicate a write from master to slave.

All transfers consist of 8 bits and a response bit: 0 for Acknowledge (ACK) or 1 for Not Acknowledge (NACK). After the ACK is received, another data byte can be transferred or the communication can be stopped with a STOP bit.

The HS40xx series sensors are equipped with different commands to configure the chip and to perform measurement as described in Table 6.

Table 6. Commands Code and Description

Command Code (HEX)	Description
0xE3	Hold Temperature Measurement
0xF3	No-hold Temperature Measurement
0xE5	Hold Humidity and Temperature Measurement
0xF5	No-hold Humidity and Temperature Measurement
0xA7	Read Register
0xA6	Write Register
0x30	Stop Periodic Measurements
0xD7	Read Sensor ID

The Hold and No-hold commands are described in section 7.4, and the read and write register commands are described in section 7.7. The HS40xx sensor can measure only temperature or both humidity and temperature as described in Table 7. Both options return fully calibrated measurements that can be converted to humidity and temperature readings using the equations in section 7.4.3. To soft reset the sensor, see section 7.10.

Table 7. Measurement Command Modes

Measurement Command Mode	Description	Number of Data Bytes Sent on the I ² C Bus
Temperature	The chip only measures temperature and sends the 14-bit result once the measurement is complete.	2 bytes + 1 byte CRC
Humidity and Temperature	The chip measures humidity and temperature and sends the 14-bit humidity result followed by the 14-bit temperature result once the measurement is complete.	4 bytes + 1 byte CRC

7.4 Measurements and Commands

There are two types of measurement commands:

1. Hold Measurement commands – The HS40xx series sensor holds the SCL line low during the measurement and releases the SCL line when the measurement is complete. This lets the master know exactly when the measurement has finished. Using this mode will prevent the master from communicating with any other slave until the measurement is complete. Note that the minimum frequency for the SCL clock in this mode is 200kHz.
2. No-hold Measurement commands – The HS40xx series sensor does not hold the SCL line low, and the master is free to initiate communication with other slaves while the chip is performing the measurement. To obtain the measurement data, the master must request the result from the chip after the expected conversion time which depends on the measurement resolution as summarized in section 7.4.4. There is no minimum clock frequency when in this mode.

7.4.1 Performing a Hold Measurement

A hold measurement sequence consists of the following steps, as displayed in Figure 13. The minimum SCL clock frequency in this mode is 200kHz.

1. Wake up the HS40xx series sensor from sleep mode by sending its I²C address with a write bit and initiate a measurement by sending the desired hold measurement command.
2. Change the direction of communication by sending a start bit, the HS40xx I²C address, and a read bit. The SCL line is held low by the sensor during the measurement process, which prevents the master from initiating any communications with other slaves on the bus.

Once the requested measurement is completed by the HS40xx series sensor, the SCL line is released and the chip waits for the SCL clock signal to send the results. The sensor will then transmit the requested measurement data on the bus for the master to capture and enters sleep mode again after 20µs.

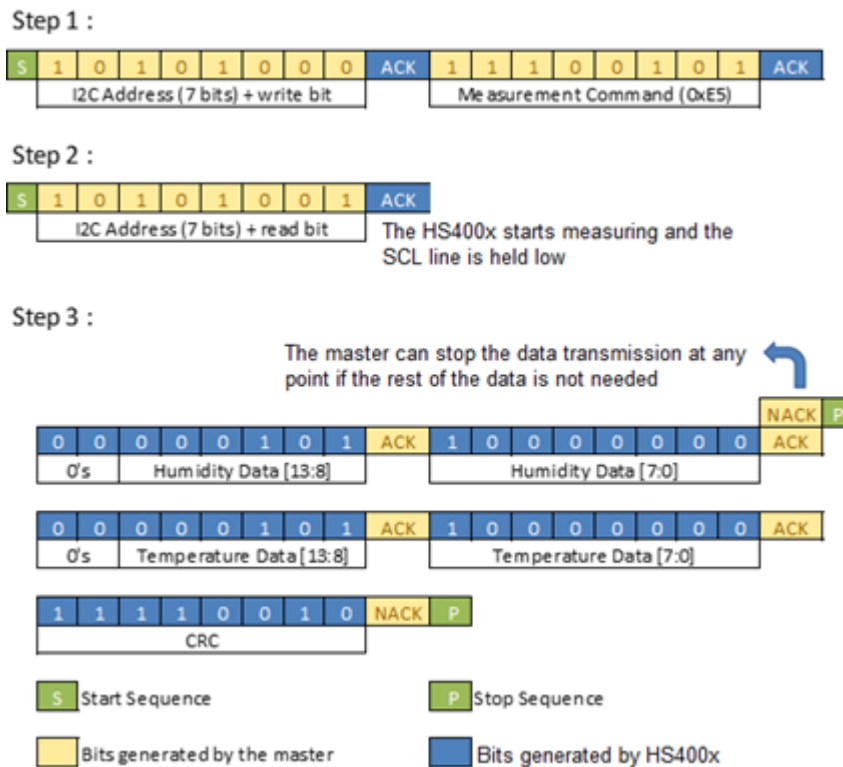

Figure 13. Typical Hold Measurement Sequence for a Humidity and Temperature Command

7.4.2 Performing a No-Hold Measurement

A no-hold measurement sequence consists of the following steps, as displayed in Figure 14.

1. Wake up the HS40xx series sensor from sleep mode by sending its I²C address with a write bit and initiate a measurement by sending the desired no-hold measurement command.
2. To read the result from the HS40xx series sensor, the master has to send the chip its I²C address and a read bit. If the measurement is completed and the result is ready, the chip will send an ACK bit and start to send the result over the bus and then enter sleep mode again after 20µs. If the measurement is still in progress, the chip will send a NACK bit and the master will need to try to read the result again.

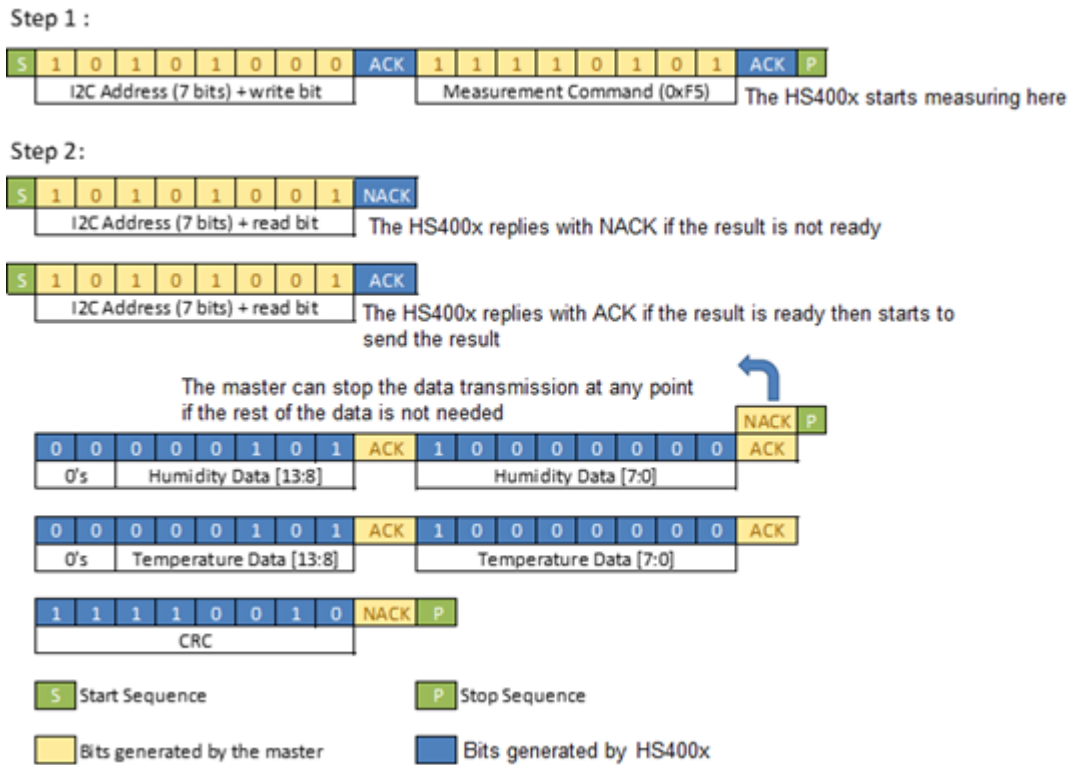

Figure 14. Typical No-Hold Measurement Sequence for a Humidity and Temperature Command

7.4.3 Calculating Humidity and Temperature Output

As indicated in Table 7, the measurement data can be either two or four bytes long depending on whether a temperature measurement or a humidity and temperature measurement was initiated. The most significant bit of the reading is sent first followed by the least significant bits. The humidity and temperature measurements are always scaled up to a 14-bit value regardless of the selected resolution of the sensor. The relative humidity (in percent) and the temperature (in degrees Celsius) are obtained as follows:

The relative humidity (in percent) and the temperature (in degrees Celsius) are calculated with Equation 1 and Equation 2, respectively.

$$Humidity [\%RH] = \frac{Humidity[13:0]}{2^{14} - 1} * 100 \tag{Equation 1}$$

$$Temperature [^{\circ}C] = \frac{Temperature [13:0]}{2^{14} - 1} * 165 - 40 \tag{Equation 2}$$

7.4.4 Measurement Conversion Times

The HS40xx series sensors are designed to have relatively fast conversion times. The conversion time depends on the resolution of the measurement and the command type (temperature or humidity and temperature). Table 8 summarizes the conversion times for different resolutions.

Table 8. Conversion Times

Measurement	Resolution (bits)	Measurement Time (ms)
Temperature	8	0.37
	10	0.45
	12	0.60
	14 (default)	0.91
Humidity and Temperature ^[1]	8	0.64
	10	0.80
	12	1.04
	14 (default)	1.70

1. Assuming the same resolution settings for both humidity and temperature measurements.

7.4.5 CRC Checksum Calculation

An 8-bit CRC checksum is transmitted after each measurement so that the user can check for data corruption during communications if desired. The properties of the CRC algorithm used are summarized in Table 9, and the CRC is based on all 4 bytes of measurement data (2 bytes of humidity data followed by 2 bytes of temperature data). For temperature-only measurements, the 2 bytes of humidity data are set to be all zeros for the CRC calculation.

Table 9. CRC Checksum Properties

Property	Value
Input Data Width	32 bits
CRC Width	8 bits
Polynomial	0x1D ($x^8 + x^4 + x^3 + x^2 + 1$)
Initial Value	0xFF
Final XOR Value	0x00
Reflect Input	No
Reflect Output	No
Example	CRC (0x05800580) = 0xF2

7.5 Periodic Measurement Mode

The HS40xx sensors can also be configured to measure at regular intervals without user intervention, and the process to enable this mode is described in section 7.8.2. In this mode, the user can read the latest relative humidity / temperature data by issuing a data fetch sequence, which consists of sending the HS40xx I²C address with a read bit. The sensor will then send the latest measurement result over the I²C bus. The data fetch sequence is displayed in Figure 15.

Step 1 :

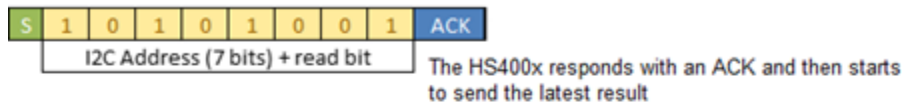

Step 2:

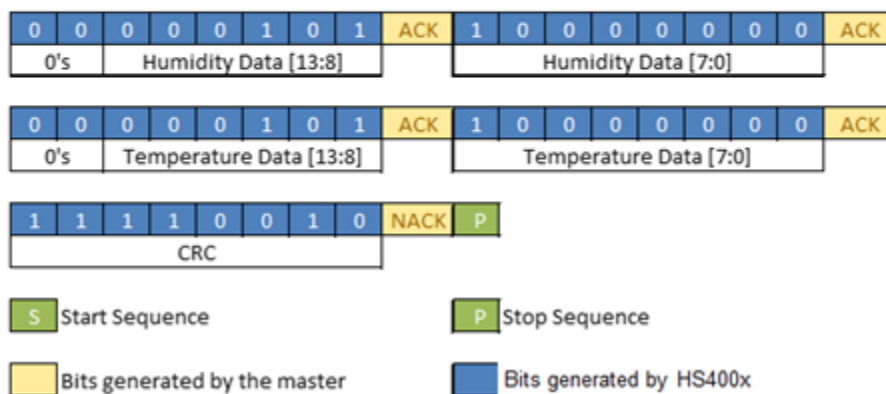

Figure 15. Sequence to Retrieve the Latest Results in Periodic Measurement Mode

The frequency of the periodic measurements can be set using the configuration registers. Section 7.7 describes how these registers are accessed, and section 7.8.2 provides the register settings needed to configure and activate the periodic measurements.

When the periodic measurement mode is active, the only commands the chip will respond to are the data fetch command, and a command to stop the periodic measurements. The sensor will not enter sleep mode while in periodic measurement mode. The command to stop periodic measurements is issued by sending the I²C address with a write bit, followed by the command 0x30, as shown in Figure 16. Once the periodic measurements have been stopped, the chip returns to sleep and is ready to accept all valid I²C commands.

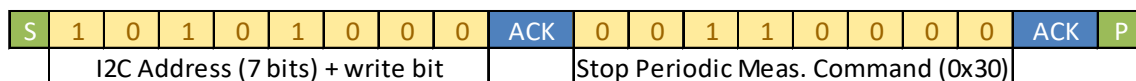

Figure 16. Sequence to Stop Periodic Measurements

7.6 Alert Feature

The HS40xx sensors have an optional Alert feature that can be configured in the following two ways:

1. The Alert pin can be used to indicate when a measurement is active in periodic measurement mode. This is the default behavior of the Alert pin upon power-up.
2. The Alert pin can be used to trigger an interrupt on the system microcontroller so an appropriate action can be taken if the temperature or humidity is outside of the desired limits.

These features are described in the following two sub-sections.

7.6.1 Alert Pin – Measurement Active

The default behavior of the Alert pin is to indicate when a measurement is active if periodic measurement mode is used. Upon power-up, the Alert pin will have a logic high level. When periodic measurement mode is activated, the Alert pin will have a logic low level between measurements and a logic high during measurements. This behavior is shown in Figure 17, and the Alert pin will exhibit this functionality when the temperature and humidity alerts are disabled (see Table 13).

If periodic measurement mode is not active, the Alert pin will remain at a logic high level.

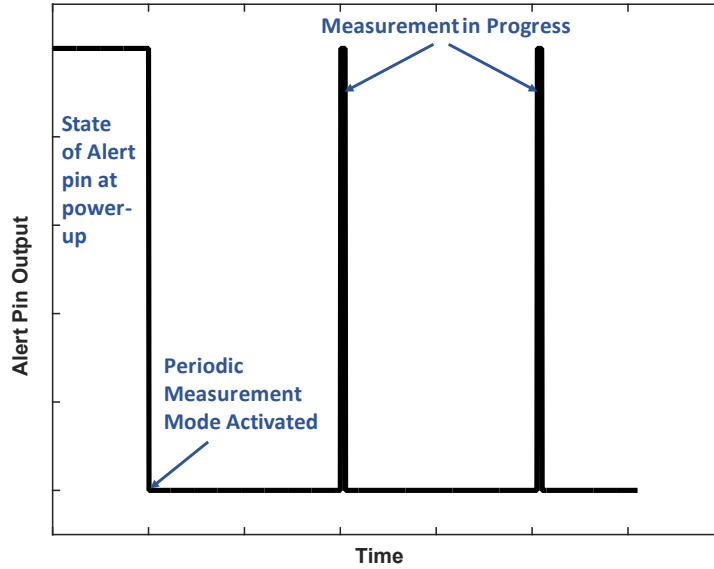

Figure 17. Alert Pin Function

7.6.2 Alert Pin – Humidity and Temperature Threshold Detection

The Alert pin can also be configured to send a signal when a humidity / temperature threshold is exceeded, and the system needs to respond. In this mode, the Alert feature has a programmable threshold, polarity, and hysteresis, and can apply to both temperature and humidity measurements. An example of the functionality of the Alert feature is displayed in Figure 18.

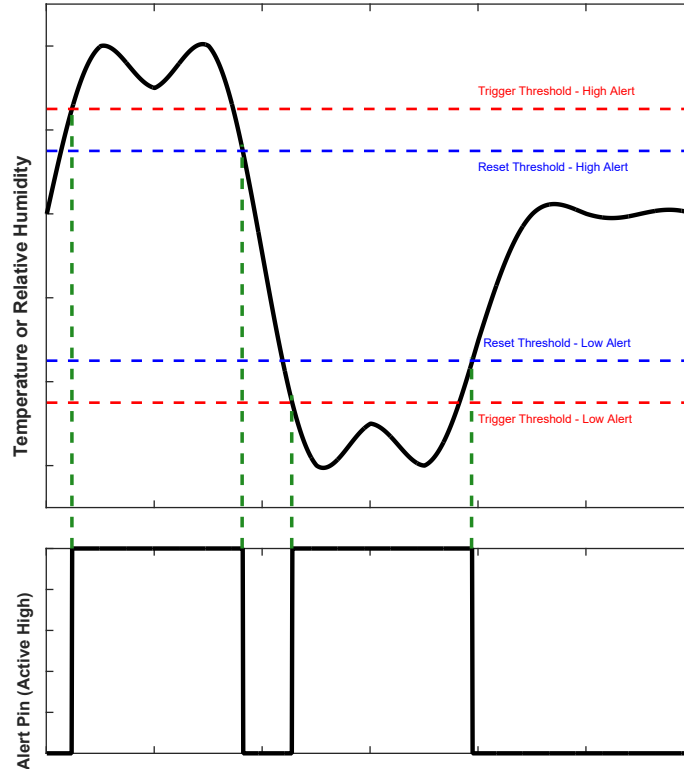

Figure 18. Alert Pin Functionality Example

The registers used to enable the Alert feature and the temperature / humidity thresholds are shown in Table 11. When the Alert feature is enabled for either humidity or temperature in periodic measurement mode, an additional status byte will precede the measurement values. The format of the bits are returned from the HS40xx sensor when any Alert is enabled as shown in Figure 19.

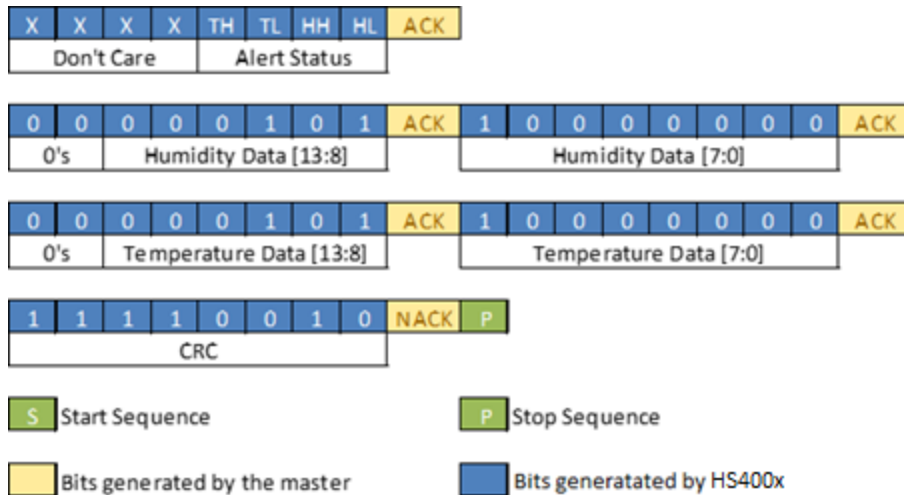

Figure 19. Data Returned from HS40xx when the Alert Feature is Enabled in Periodic Measurement Mode

The meaning of the Alert status bits are defined in Table 10.

Table 10. Alert Status Bits

Status Bit	Meaning
TH	High (0b1) if the Temperature High Alert is triggered
TL	High (0b1) if the Temperature Low Alert is triggered
HH	High (0b1) if the Humidity High Alert is triggered
HL	High (0b1) if the Humidity Low Alert is triggered

7.7 Accessing Configurable HS40xx Registers

The HS40xx measurement settings can be changed by accessing the appropriate configuration registers and altering their values. This can be done by issuing a Write Register command. A Read Register command is also available to read the configuration register values. These commands are described in this section, and the configuration registers and settings are described in section 7.8.

While accessing specific configuration bits in any register, all the other bits in that register must be left unchanged. To write a specific bit/bits in a register, the process is as follows:

1. Read the entire configuration register using the sequence described in section 7.7.1.
2. Mask the register such that only the required bits are changed according to the configuration parameters in section 7.8.
3. Write the new register back to the appropriate address using the Write Register command sequence described in section 7.7.2.

All configuration registers will be reset to their default values if the power supply to the chip is cut off.

7.7.1 Read Register Command

A Read Register sequence consists of the following steps, as illustrated in Figure 20.

1. Wake up the HS40xx series sensor from sleep mode by sending its I²C address with a write bit and initiate a Read Register command by sending the command 0xA7.
2. Send the address of the register to be read.
3. Change the direction of communication by sending the HS40xx I²C address and a read bit. The chip will send the data stored in this register, after which the master replies with a NACK and a STOP bit.

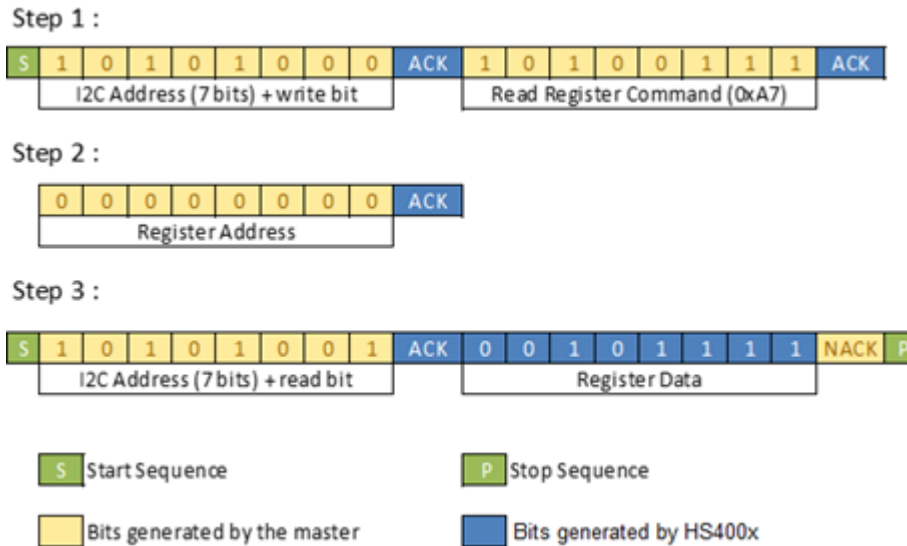

Figure 20. Read Register Command Sequence

7.7.2 Write Register Command

A Write Register sequence consists of the following steps, as illustrated in Figure 21.

1. Wake up the HS40xx series sensor from sleep mode by sending its I²C address with a write bit and initiate a Write Register command by sending the command 0xA6.
2. Send the address of the register to write.
3. Send the data to be stored in this register followed by a STOP bit.

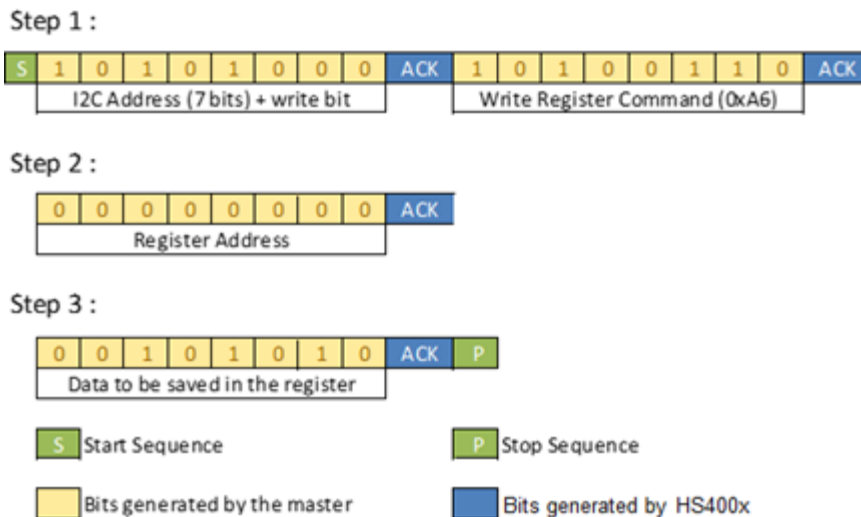

Figure 21. Write Register Command Sequence

7.8 Configuration Bits

7.8.1 Setting the Measurement Resolution

The HS40xx can be configured to perform measurements at different humidity and temperature resolutions by using the Read and Write Register commands with the appropriate register address. There are four separate resolution settings for the temperature and humidity measurements, as summarized in Table 11.

Table 11. Temperature and Humidity Measurement Resolution Settings

Setting	Register Address (HEX)	Bits	Description
Resolution for Temperature Measurement	0x00	1:0	0b00 for 8 bits
			0b01 for 10 bits
			0b10 for 12 bits
			0b11 for 14 bits (default)
Resolution for Humidity Measurement	0x00	3:2	0b00 for 8 bits
			0b01 for 10 bits
			0b10 for 12 bits
			0b11 for 14 bits (default)

7.8.2 Periodic Measurement Settings

The registers that are used to activate and configure the periodic measurement settings are shown in Table 12.

Table 12. Periodic Measurement Settings

Setting	Register Address (HEX)	Bits	Description
Activate Periodic Measurements	0x02	7	0b0 when periodic measurements are deactivated
			0b1 to activate periodic measurements
Frequency of Periodic Measurements	0x02	5:4	0b00 for a measurement every 0.5s
			0b01 for a measurement every 1s (default)
			0b10 for a measurement every 2.5s

Table 13. Alert Feature Settings

Setting	Register Address (HEX)	Bits	Description																																														
Alert Pin Polarity In Humidity/Temperature Threshold Detection Mode	0x02	0	0b1 = Alert pin is active high when triggered (default)																																														
			0b0 = Alert pin is active low when triggered																																														
Alert Enable Settings	0x03	3:0	<p>Enable the Alert feature when thresholds are surpassed as follows:</p> <p>Bit 0 = RH Low alert enable Bit 1 = RH High alert enable Bit 2 = Temperature Low alert enable Bit 3 = Temperature High alert enable</p> <p>Setting a bit to 0b1 means this specific alert condition is enabled and setting a bit to 0b0 means this specific alert condition is disabled.</p>																																														
Trigger Threshold for Temperature High Alert	0x08, 0x07	13:0	<p>Registers 0x08, 0x07 set the threshold for when the “Temperature High” alert is triggered. When the measured temperature goes above the value in this register, the Alert pin will be triggered.</p> <p>The temperature used for the threshold is composed of 14 bits as follows:</p> <table border="1" style="margin-left: auto; margin-right: auto;"> <tr> <th colspan="7">Register 0x08</th> <th colspan="7">Register 0x07</th> </tr> <tr> <td>0</td><td>0</td><td>0</td><td>0</td><td>0</td><td>0</td><td>1</td> <td>0</td><td>1</td><td>1</td><td>0</td><td>0</td><td>0</td><td>0</td><td>0</td><td>0</td><td>0</td> </tr> <tr> <td colspan="7">0's</td> <td colspan="4">Trigger Threshold [13:8]</td> <td colspan="4">Trigger Threshold [7:0]</td> </tr> </table> <p>This 14-bit value is converted into a temperature threshold using the same conversion equation shown in section 7.4.3.</p>	Register 0x08							Register 0x07							0	0	0	0	0	0	1	0	1	1	0	0	0	0	0	0	0	0's							Trigger Threshold [13:8]				Trigger Threshold [7:0]			
Register 0x08							Register 0x07																																										
0	0	0	0	0	0	1	0	1	1	0	0	0	0	0	0	0																																	
0's							Trigger Threshold [13:8]				Trigger Threshold [7:0]																																						
Reset Threshold for Temperature High Alert	0x06, 0x05	13:0	<p>Registers 0x06, 0x05 set the threshold for when the “Temperature High” alert condition is reset. After the alert is triggered, it will only be reset after the measured temperature goes below the value in this register.</p> <p>The temperature used for the threshold is composed of 14 bits as follows:</p> <table border="1" style="margin-left: auto; margin-right: auto;"> <tr> <th colspan="7">Register 0x06</th> <th colspan="7">Register 0x05</th> </tr> <tr> <td>0</td><td>0</td><td>0</td><td>0</td><td>0</td><td>0</td><td>1</td> <td>0</td><td>1</td><td>1</td><td>0</td><td>0</td><td>0</td><td>0</td><td>0</td><td>0</td><td>0</td> </tr> <tr> <td colspan="7">0's</td> <td colspan="4">Reset Threshold [13:8]</td> <td colspan="4">Reset Threshold [7:0]</td> </tr> </table> <p>This 14-bit value is converted into a temperature threshold using the same conversion equation shown in section 7.4.3.</p>	Register 0x06							Register 0x05							0	0	0	0	0	0	1	0	1	1	0	0	0	0	0	0	0	0's							Reset Threshold [13:8]				Reset Threshold [7:0]			
Register 0x06							Register 0x05																																										
0	0	0	0	0	0	1	0	1	1	0	0	0	0	0	0	0																																	
0's							Reset Threshold [13:8]				Reset Threshold [7:0]																																						
Trigger Threshold for Temperature Low Alert	0x0A, 0x09	13:0	<p>Registers 0x0A, 0x09 set the threshold for when the “Temperature Low” alert is triggered. When the measured temperature goes below the value in this register, the Alert pin will be triggered.</p> <p>The temperature used for the threshold is composed of 14 bits as follows:</p> <table border="1" style="margin-left: auto; margin-right: auto;"> <tr> <th colspan="7">Register 0x0A</th> <th colspan="7">Register 0x09</th> </tr> <tr> <td>0</td><td>0</td><td>0</td><td>0</td><td>0</td><td>0</td><td>1</td> <td>0</td><td>1</td><td>1</td><td>0</td><td>0</td><td>0</td><td>0</td><td>0</td><td>0</td><td>0</td> </tr> <tr> <td colspan="7">0's</td> <td colspan="4">Trigger Threshold [13:8]</td> <td colspan="4">Trigger Threshold [7:0]</td> </tr> </table> <p>This 14-bit value is converted into a temperature threshold using the same conversion equation shown in section 7.4.3.</p>	Register 0x0A							Register 0x09							0	0	0	0	0	0	1	0	1	1	0	0	0	0	0	0	0	0's							Trigger Threshold [13:8]				Trigger Threshold [7:0]			
Register 0x0A							Register 0x09																																										
0	0	0	0	0	0	1	0	1	1	0	0	0	0	0	0	0																																	
0's							Trigger Threshold [13:8]				Trigger Threshold [7:0]																																						
Reset Threshold for Temperature Low Alert	0x0C, 0x0B	13:0	<p>Registers 0x0C, 0x0B set the threshold for when the “Temperature Low” alert condition is reset. After the alert is triggered, it will only be reset after the measured temperature goes above the value in this register.</p> <p>The temperature used for the threshold is composed of 14 bits as follows:</p> <table border="1" style="margin-left: auto; margin-right: auto;"> <tr> <th colspan="7">Register 0x0C</th> <th colspan="7">Register 0x0B</th> </tr> <tr> <td>0</td><td>0</td><td>0</td><td>0</td><td>0</td><td>0</td><td>1</td> <td>0</td><td>1</td><td>1</td><td>0</td><td>0</td><td>0</td><td>0</td><td>0</td><td>0</td><td>0</td> </tr> <tr> <td colspan="7">0's</td> <td colspan="4">Reset Threshold [13:8]</td> <td colspan="4">Reset Threshold [7:0]</td> </tr> </table> <p>This 14-bit value is converted into a temperature threshold using the same conversion equation shown in section 7.4.3.</p>	Register 0x0C							Register 0x0B							0	0	0	0	0	0	1	0	1	1	0	0	0	0	0	0	0	0's							Reset Threshold [13:8]				Reset Threshold [7:0]			
Register 0x0C							Register 0x0B																																										
0	0	0	0	0	0	1	0	1	1	0	0	0	0	0	0	0																																	
0's							Reset Threshold [13:8]				Reset Threshold [7:0]																																						

Setting	Register Address (HEX)	Bits	Description																																												
Trigger Threshold for Relative Humidity High Alert	0x10, 0x0F	13:0	<p>Registers 0x10, 0x0F set the threshold for when the “RH High” alert is triggered. When the measured RH goes above the value in this register, the Alert pin will be triggered.</p> <p>The humidity used for the threshold is composed of 14 bits as follows:</p> <table border="1"> <tr> <th colspan="7">Register 0x10</th> <th colspan="7">Register 0x0F</th> </tr> <tr> <td>0</td><td>0</td><td>0</td><td>0</td><td>0</td><td>1</td><td>0</td><td>1</td><td>1</td><td>0</td><td>0</td><td>0</td><td>0</td><td>0</td><td>0</td><td>0</td> </tr> <tr> <td colspan="7">0's</td> <td colspan="7">Trigger Threshold [7:0]</td> </tr> </table> <p>This 14-bit value is converted into a humidity threshold using the same conversion equation shown in section 7.4.3.</p>	Register 0x10							Register 0x0F							0	0	0	0	0	1	0	1	1	0	0	0	0	0	0	0	0's							Trigger Threshold [7:0]						
Register 0x10							Register 0x0F																																								
0	0	0	0	0	1	0	1	1	0	0	0	0	0	0	0																																
0's							Trigger Threshold [7:0]																																								
Reset Threshold for Relative Humidity High Alert	0x0E, 0x0D	13:0	<p>Registers 0x0E, 0x0D set the threshold for when the “RH High” alert condition is reset. After the alert is triggered, it will only be reset after the measured RH goes below the value in this register.</p> <p>The humidity used for the threshold is composed of 14 bits as follows:</p> <table border="1"> <tr> <th colspan="7">Register 0x0E</th> <th colspan="7">Register 0x0D</th> </tr> <tr> <td>0</td><td>0</td><td>0</td><td>0</td><td>0</td><td>1</td><td>0</td><td>1</td><td>1</td><td>0</td><td>0</td><td>0</td><td>0</td><td>0</td><td>0</td><td>0</td> </tr> <tr> <td colspan="7">0's</td> <td colspan="7">Reset Threshold [7:0]</td> </tr> </table> <p>This 14-bit value is converted into a humidity threshold using the same conversion equation shown in section 7.4.3.</p>	Register 0x0E							Register 0x0D							0	0	0	0	0	1	0	1	1	0	0	0	0	0	0	0	0's							Reset Threshold [7:0]						
Register 0x0E							Register 0x0D																																								
0	0	0	0	0	1	0	1	1	0	0	0	0	0	0	0																																
0's							Reset Threshold [7:0]																																								
Trigger Threshold for Relative Humidity Low Alert	0x12, 0x11	13:0	<p>Registers 0x12, 0x11 set the threshold for when the “RH Low” alert is triggered. When the measured RH goes below the value in this register, the Alert pin will be triggered.</p> <p>The humidity used for the threshold is composed of 14 bits as follows:</p> <table border="1"> <tr> <th colspan="7">Register 0x12</th> <th colspan="7">Register 0x11</th> </tr> <tr> <td>0</td><td>0</td><td>0</td><td>0</td><td>0</td><td>1</td><td>0</td><td>1</td><td>1</td><td>0</td><td>0</td><td>0</td><td>0</td><td>0</td><td>0</td><td>0</td> </tr> <tr> <td colspan="7">0's</td> <td colspan="7">Trigger Threshold [7:0]</td> </tr> </table> <p>This 14-bit value is converted into a humidity threshold using the same conversion equation shown in section 7.4.3.</p>	Register 0x12							Register 0x11							0	0	0	0	0	1	0	1	1	0	0	0	0	0	0	0	0's							Trigger Threshold [7:0]						
Register 0x12							Register 0x11																																								
0	0	0	0	0	1	0	1	1	0	0	0	0	0	0	0																																
0's							Trigger Threshold [7:0]																																								
Reset Threshold for Relative Humidity Low Alert	0x14, 0x13	13:0	<p>Registers 0x14, 0x13 sets the threshold for when the “RH Low” alert condition is reset. After the alert is triggered, it will only be reset after the measured RH goes above the value in this register.</p> <p>The humidity used for the threshold is composed of 14 bits as follows:</p> <table border="1"> <tr> <th colspan="7">Register 0x14</th> <th colspan="7">Register 0x13</th> </tr> <tr> <td>0</td><td>0</td><td>0</td><td>0</td><td>0</td><td>1</td><td>0</td><td>1</td><td>1</td><td>0</td><td>0</td><td>0</td><td>0</td><td>0</td><td>0</td><td>0</td> </tr> <tr> <td colspan="7">0's</td> <td colspan="7">Reset Threshold [7:0]</td> </tr> </table> <p>This 14-bit value is converted into a humidity threshold using the same conversion equation shown in section 7.4.3.</p>	Register 0x14							Register 0x13							0	0	0	0	0	1	0	1	1	0	0	0	0	0	0	0	0's							Reset Threshold [7:0]						
Register 0x14							Register 0x13																																								
0	0	0	0	0	1	0	1	1	0	0	0	0	0	0	0																																
0's							Reset Threshold [7:0]																																								

7.9 Reading the Sensor ID Number

The sensor ID is a 32-bit number that can be used to identify a specific device. Each sensor has a unique ID that can be used for traceability. The sequence to read the sensor ID is as follows:

1. Wake up the HS40xx series sensor from sleep mode by sending its I²C address with a write bit and initiate a Read Sensor ID command by sending the command 0xD7.
2. Change the direction of communication by sending the HS40xx I²C address and a read bit. The SCL line is held low by the sensor while it retrieves the ID from internal memory to prevent data corruption. The sensor takes approximately 10µs to retrieve the ID from internal memory.

- Once the request is completed by the HS40xx, the SCL line is released and the chip waits for the SCL clock signal to send the results. The sensor will then transmit the 4-byte sensor ID on the bus for the master to capture, MSB first.

The command sequence to read the sensor ID is displayed in Figure 22.

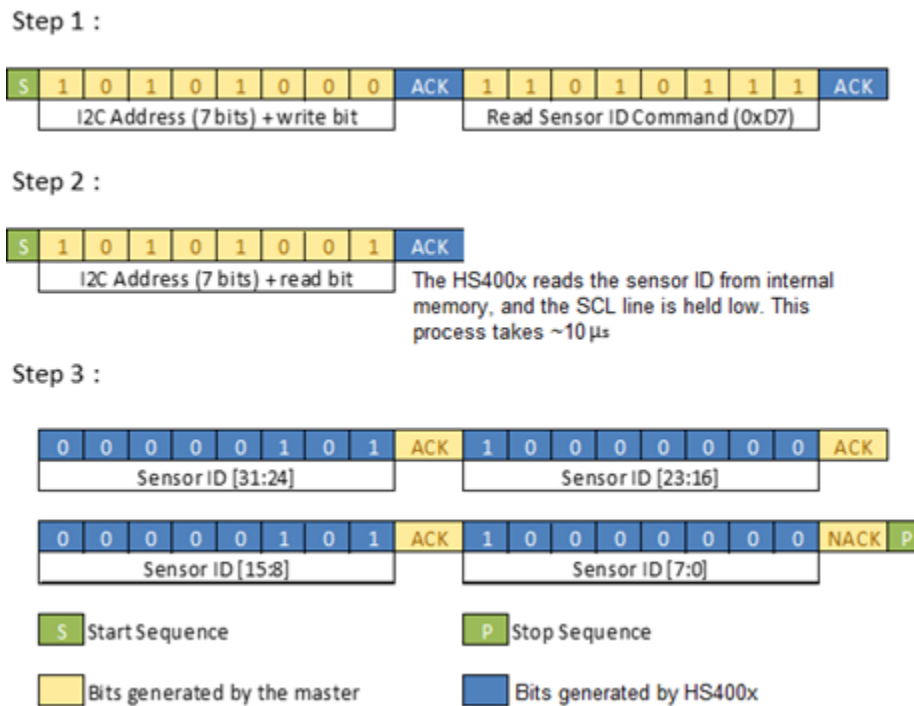

Figure 22. Read Sensor ID Command Sequence

7.10 Resetting the Sensor

With the command 0xFE, it is possible to soft reset the HS40xx. The reset will affect all writeable registers and sets them back to the default value. To use this command, ensure that the following conditions are met:

- If the user initiates a measurement, they must read the measurement data before issuing the soft reset command.
- If the user has the HS40xx in Periodic Measurement Mode, they must escape the “Periodic Measurement Mode” before issuing the soft reset command. This can be achieved by sending the “Stop Periodic Measurement” command.

To reset the sensor, use the following sequence:

- Wake up the HS40xx series sensor from sleep mode by sending its I²C address with a write bit.
- Send the soft reset command 0xFE.

After sending the reset command, wait for at least 500ms before starting to communicate with the HS40xx. The sensor will behave like it was just powered on.

8. Soldering Information

This section discusses soldering considerations for the HS40xx.

Standard reflow ovens can be used to solder the HS40xx series sensor to the PCB. The peak temperature (T_p) for use with the JEDEC J-STD-020D standard soldering profile is 260°C. For manual soldering, the contact time must be limited to 5 seconds at up to 350°C. In either case, if solder paste is used, it is recommended to use “no-clean” solder paste to avoid the need to wash the PCB.

When a relative humidity sensor is exposed to the high heat associated with the soldering process, the sensor element tends to dry out. To avoid an offset in the relative humidity readings, the sensor element must be rehydrated after the soldering process. Care must also be taken when selecting the temperatures and durations involved in the soldering process to avoid irreversibly damaging the sensor element.

The recommended soldering profile for a lead-free (RoHS-compliant) process is shown below.

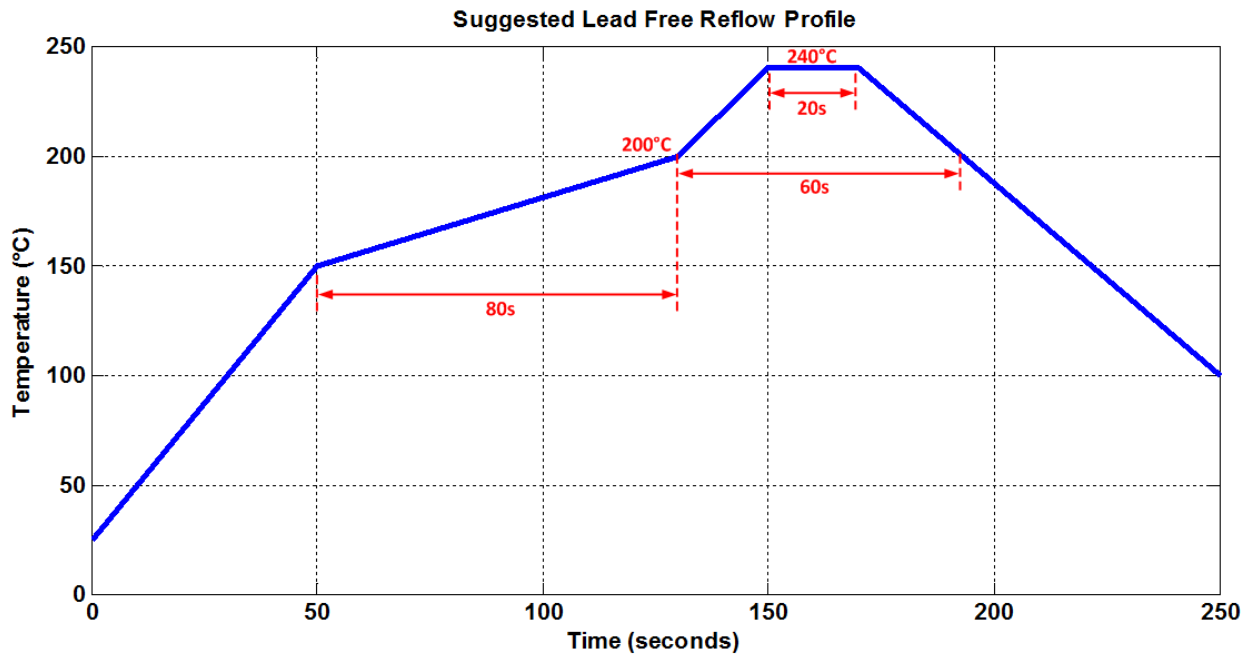

Figure 23. Recommended Soldering Profile

Important: Ensure this temperature profile is measured at the sensor itself. Measuring the profile at a larger component with a higher thermal mass means the temperature at the small sensor will be higher than expected.

For manual soldering, the contact time must be limited to **5 seconds** with a maximum iron temperature of **350°C**.

In either case, a board wash after soldering is **not** recommended. Therefore, if a solder paste is used, it is strongly recommended that a “no-clean” solder paste is used to avoid the need to wash the PCB.

After soldering, the recommended rehydration process in section 4 should be performed; otherwise, there may be an initial offset in the relative humidity readings, which will slowly disappear as the sensor get exposed to ambient conditions.

9. Storage and Handling

Recommendation: Once the sensors are removed from their original packaging, store them in metal-in antistatic bags.

Avoid using polyethylene antistatic bags as they may affect sensor accuracy.

The nominal storage conditions are 10°C to 50°C and humidity levels within 20% to 60%RH. If stored outside of these conditions for extended periods of time, the sensor readings may exhibit an offset. The sensor can be reconditioned and returned to its calibration state by applying the procedure described in section 4.

10. Quality and Reliability

The HS40xx series is available as a qualified product for consumer and industrial market applications. All data specified parameters are guaranteed if not stated otherwise.

11. Package Outline Drawings

The package outline drawings are located at the end of this document and are accessible from the Renesas website. The package information is the most current data available and is subject to change without revision of this document.

12. Marking Diagram

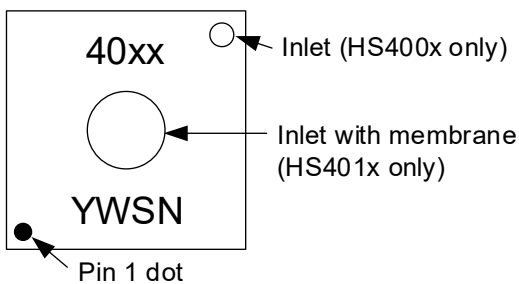

- Line 1: Sensor type (for example, 4011)
- Line 2:
 - First character: Year (for example, 3 = 2023)
 - Second character: Week code (for example, X = 31)
 - Third and fourth character: Test Release Sequence Number

13. Ordering Information

Part Number	Package Description	Carrier Type	Temperature Range
HS4001	Digital Relative Humidity and Temperature Sensor, $\pm 1.5\%$ RH (typical), 2.50 × 2.50 × 0.90 mm, 8-LGA	Reel	-40°C to +125°C
HS4003	Digital Relative Humidity and Temperature Sensor, $\pm 2.5\%$ RH (typical), 2.50 × 2.50 × 0.90 mm, 8-LGA	Reel	-40°C to +125°C
HS4011	Digital Relative Humidity and Temperature Sensor, with membrane. $\pm 1.5\%$ RH (typical), 2.50 × 2.50 × 0.90 mm, 8-LGA	Reel	-40°C to +125°C
HS4013	Digital Relative Humidity and Temperature Sensor, with membrane. $\pm 2.5\%$ RH (typical), 2.50 × 2.50 × 0.90 mm, 8-LGA	Reel	-40°C to +125°C

14. Revision History

Revision	Date	Description
1.03	Jun 14, 2024	Updated PCB Layout Guidelines section.
1.02	Mar 25, 2024	<ul style="list-style-type: none">▪ Changed the order of various sections.▪ Updated the "Product Image" on front page.▪ Changed Pin Assignments diagram to "Top View" from "Bottom View".▪ Added I²C voltage specifications to Table 2.▪ Updated the bit description for 0x02 in Table 13.
1.01	Nov 3, 2023	<ul style="list-style-type: none">▪ Added Functional Diagram.▪ Added the Conditioning section.▪ Added the "Resetting the Sensor" section.▪ Updated the "Pin Assignments" and "Pin Descriptions" sections.▪ Updated performance characteristics.▪ Updated "Soldering Information" and "Storage and Handling" sections.
1.00	Aug 11, 2023	Initial release.

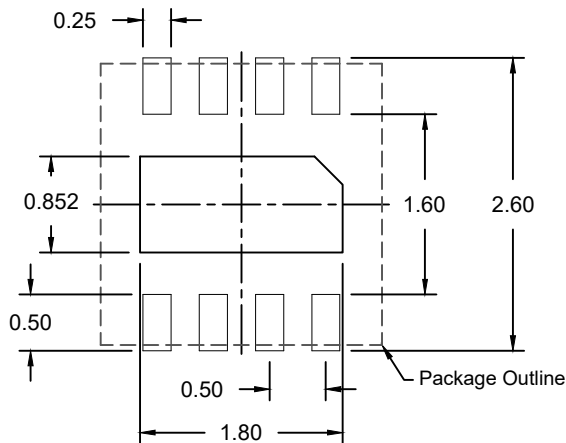
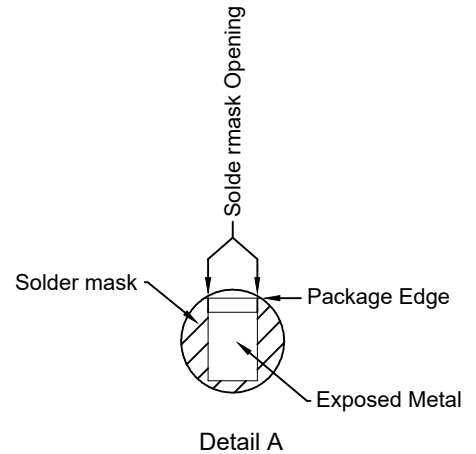
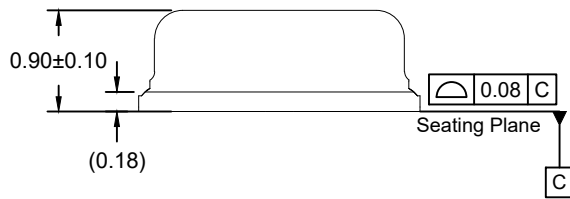
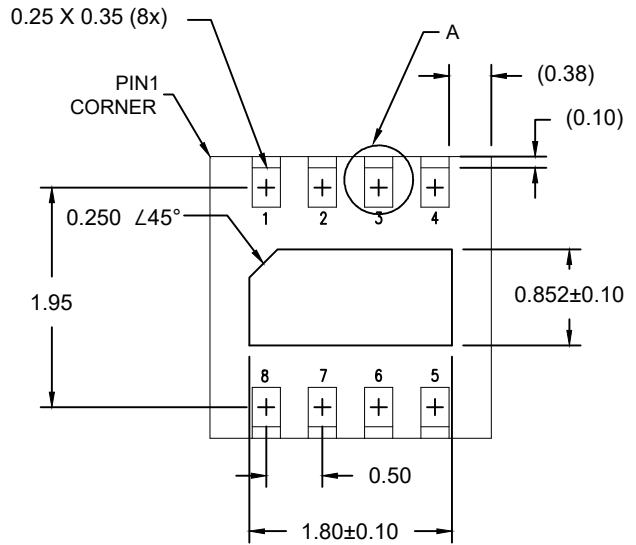
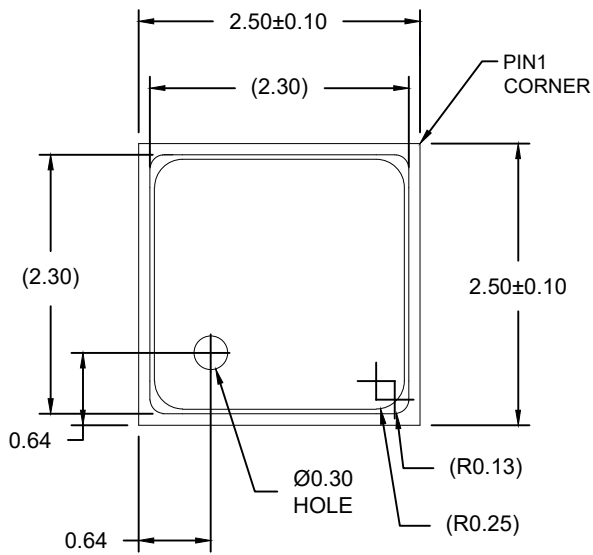

NOTES:

1. JEDEC compatible
2. All dimensions are in mm, angles in degrees.
3. Use ± 0.05 mm for non-toleranced dimensions.
4. Numbers in () are for reference only.

IMPORTANT NOTICE AND DISCLAIMER

RENESAS ELECTRONICS CORPORATION AND ITS SUBSIDIARIES (“RENESAS”) PROVIDES TECHNICAL SPECIFICATIONS AND RELIABILITY DATA (INCLUDING DATASHEETS), DESIGN RESOURCES (INCLUDING REFERENCE DESIGNS), APPLICATION OR OTHER DESIGN ADVICE, WEB TOOLS, SAFETY INFORMATION, AND OTHER RESOURCES “AS IS” AND WITH ALL FAULTS, AND DISCLAIMS ALL WARRANTIES, EXPRESS OR IMPLIED, INCLUDING, WITHOUT LIMITATION, ANY IMPLIED WARRANTIES OF MERCHANTABILITY, FITNESS FOR A PARTICULAR PURPOSE, OR NON-INFRINGEMENT OF THIRD-PARTY INTELLECTUAL PROPERTY RIGHTS.

These resources are intended for developers who are designing with Renesas products. You are solely responsible for (1) selecting the appropriate products for your application, (2) designing, validating, and testing your application, and (3) ensuring your application meets applicable standards, and any other safety, security, or other requirements. These resources are subject to change without notice. Renesas grants you permission to use these resources only to develop an application that uses Renesas products. Other reproduction or use of these resources is strictly prohibited. No license is granted to any other Renesas intellectual property or to any third-party intellectual property. Renesas disclaims responsibility for, and you will fully indemnify Renesas and its representatives against, any claims, damages, costs, losses, or liabilities arising from your use of these resources. Renesas' products are provided only subject to Renesas' Terms and Conditions of Sale or other applicable terms agreed to in writing. No use of any Renesas resources expands or otherwise alters any applicable warranties or warranty disclaimers for these products.

(Disclaimer Rev.1.01 Jan 2024)

Corporate Headquarters

TOYOSU FORESIA, 3-2-24 Toyosu,
Koto-ku, Tokyo 135-0061, Japan
www.renesas.com

Trademarks

Renesas and the Renesas logo are trademarks of Renesas Electronics Corporation. All trademarks and registered trademarks are the property of their respective owners.

Contact Information

For further information on a product, technology, the most up-to-date version of a document, or your nearest sales office, please visit www.renesas.com/contact-us/.