

ISL91117

High Efficiency Synchronous Boost Converter with 4.2A Switches and Output Disconnect

The **ISL91117** is a highly-integrated boost switching regulator for battery powered applications. The device provides a power supply solution for products using dual-cell or three-cell alkaline, NiCd or NiMH, or one-cell Li-ion or Li-polymer battery.

This device is capable of delivering an output current of 1.5A with $P_{VIN} = 3.3V$ and $V_{OUT} = 5V$. The use of a synchronous rectifier maximizes efficiency at high loads. No-load quiescent current of only 35 μ A optimizes efficiency under light-load conditions. Forced PWM and/or synchronization to an external clock may also be selected for noise sensitive applications.

The ISL91117 is designed for standalone applications and supports variable output voltages with an external resistor divider. Power supply solution size is minimized by a 2.34mm \times 1.72mm WLCSP and a 2.6MHz switching frequency, which allows for the use of tiny, low-profile inductors and ceramic capacitors to minimize the size of the solution.

Features

- Input voltage range: 1.8V to 4.8V
- Adjustable output
- Output current: up to 1.5A ($P_{VIN} = 3.3V$, $V_{OUT} = 5V$)
- High efficiency: up to 96%
- 35 μ A quiescent current maximizes light-load efficiency
- True input-output disconnect when disabled
- 2.6MHz switching frequency minimizes external component size
- Selectable forced-PWM mode and external synchronization
- Fully protected for short-circuit, over-temperature and undervoltage
- Small 2.34mm \times 1.72mm WLCSP

Applications

- Smart phones and tablets
- Wireless communication devices
- Products including portable HDMI and USB-OTG

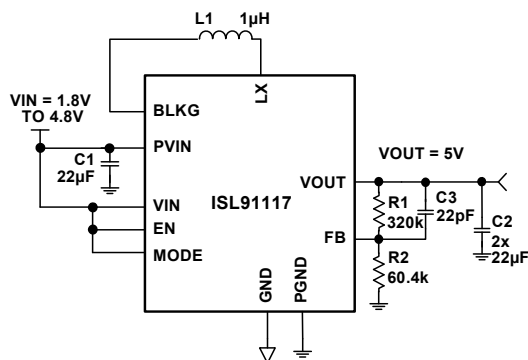

FIGURE 1. TYPICAL APPLICATION

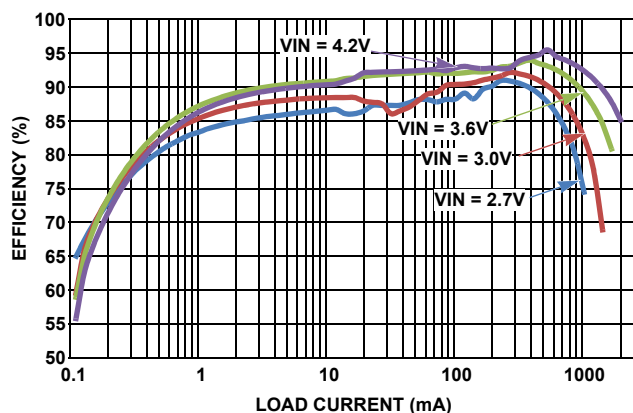
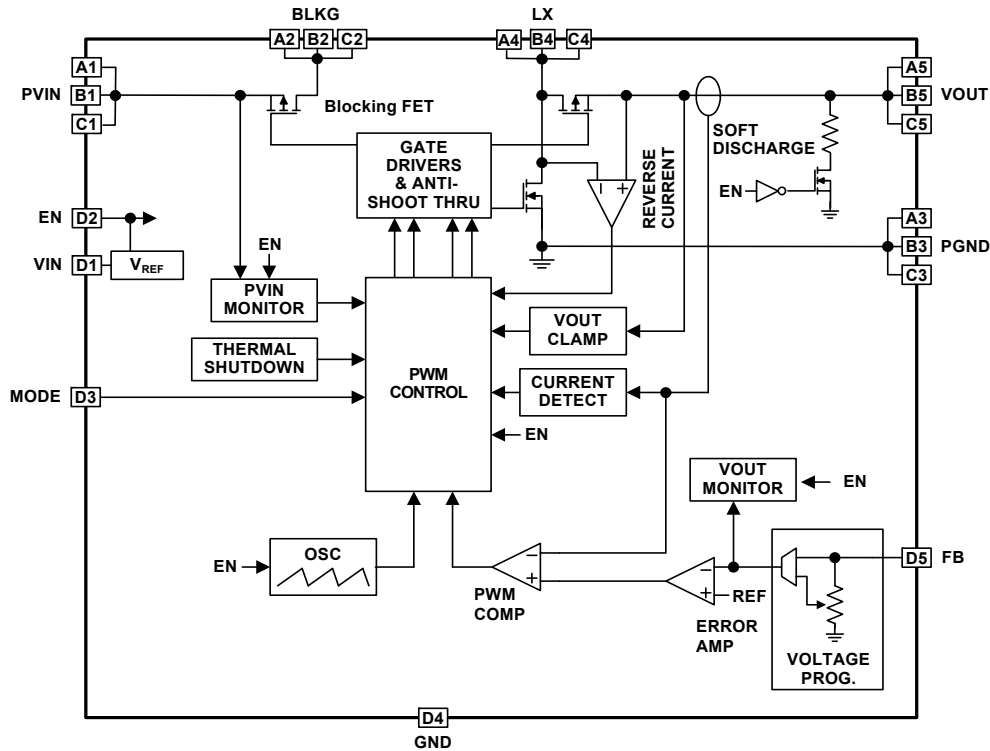

FIGURE 2. EFFICIENCY vs LOAD CURRENT ($V_{OUT} = 5V$)

Block Diagram



Pin Configuration

ISL91117
(4x5 WLCSP)
TOP VIEW

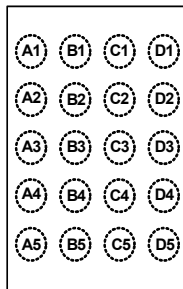

Pin Descriptions

PIN #	PIN NAMES	DESCRIPTION
A5, B5, C5	VOUT	Boost output. Connect 2x22μF capacitor to PGND.
A4, B4, C4	LX	Switching node of the boost converter.
A3, B3, C3	PGND	Power ground for high switching current.
A2, B2, C2	BLKG	Blocking FET terminal. Connect the input side of the inductor.
A1, B1, C1	PVIN	Power input. Range: 1.8V to 4.8V. Connect a 22μF capacitor to PGND.
D1	VIN	Supply input. Range: 1.8V to 4.8V.
D2	EN	Logic input, drive HIGH to enable device.
D3	MODE	Logic input, HIGH for auto PFM mode. LOW for forced PWM operation. Also, this pin can be used with an external clock sync input. Range: 2.75MHz to 3.25MHz. Maximum voltage on this pin should be limited to VIN.
D4	GND	Analog ground pin.
D5	FB	Voltage feedback pin.

Ordering Information

PART NUMBER (Notes 2, 3)	PART MARKING	VOUT (V)	PACKAGE DESCRIPTION (RoHS Compliant)	PKG. DWG. #	CARRIER TYPE (Note 1)	TEMP RANGE
ISL91117IIAZ-T	GAXB	ADJ.	20 Ball WLCSP	W4x5.20F	Reel, 3k	-40 to +85 °C
ISL91117IIAZ-T7A					Reel, 250	
ISL91117IIA-EVZ	Evaluation Board for ISL91117IIAZ					

NOTES:

1. Please refer to [TB347](#) for details on reel specifications.
2. These Pb-free WLCSP and BGA packaged products employ special Pb-free material sets; molding compounds/die attach materials and SnAgCu - e1 solder ball terminals, which are RoHS compliant and compatible with both SnPb and Pb-free soldering operations. Pb-free WLCSP and BGA packaged products are MSL classified at Pb-free peak reflow temperatures that meet or exceed the Pb-free requirements of IPC/JEDEC J STD-020.
3. For Moisture Sensitivity Level (MSL), please see device information page for [ISL91117](#). For more information on MSL please see techbrief [TB363](#).

Absolute Maximum Ratings

PVIN, VIN	-0.3V to 6.5V
LX (Note 6)	-0.3V to 6.5V
FB	-0.3V to 2.7V
MODE/SYNC	-0.3V to VIN+0.3V
GND, PGND	-0.3V to 0.3V
All Other Pins	-0.3V to 6.5V
ESD Rating	
Human Body Model (Tested per JESD22-A114E)	2.5kV
Machine Model (Tested per JESD22-A115-A)	200V
Latch Up (Tested per JESD-78B; Class 2, Level A)	100mA

Thermal Information

Thermal Resistance (Typical)	θ_{JA} (°C/W)	θ_{JC} (°C/W)
20 Ball WLCSP (Notes 4, 5)	66	1.0
Maximum Junction Temperature (Plastic Package)	+125°C	
Storage Temperature Range	-65°C to +150°C	
Pb-Free Reflow Profile	see TB493	

Recommended Operating Conditions

Temperature Range	-40°C to +85°C
Supply Voltage Range	1.8V to 4.8V
Load Current Range (DC)	0A to 1.5A

CAUTION: Do not operate at or near the maximum ratings listed for extended periods of time. Exposure to such conditions may adversely impact product reliability and result in failures not covered by warranty.

NOTES:

- θ_{JA} is measured in free air with the component mounted on a high effective thermal conductivity test board with "direct attach" features. See [TB379](#)
- For θ_{JC} , the "case temp" location is taken at the package top center.
- LX pin can withstand switching transients of -1.5V for 100ns, and 7V for 20ms.

Analog Specifications VIN = PVIN = EN = 3.6V, VOUT = 5V, L1 = 1μH, C1 = 22μF, C2 = 2 x 22μF, TA = +25°C. **Boldface limits apply over the operating temperature range, -40°C to +85°C and input voltage range (1.8V to 4.8V).**

PARAMETER	SYMBOL	TEST CONDITIONS	MIN (Note 7)	TYP	MAX (Note 7)	UNITS
POWER SUPPLY						
Input Voltage Range	VIN	-	1.8	-	4.8	V
VIN Undervoltage Lockout Threshold	VUVLO	Rising	-	1.725	1.775	V
		Falling	1.550	1.650	-	V
VIN Supply Current	I _{VIN}	PFM mode, no external load on VOUT (Note 8)	-	27.5	60	μA
VIN Supply Current, Shutdown	I _{SD}	EN = GND, V _{IN} = 3.6V	-	0.4	1.0	μA
OUTPUT VOLTAGE REGULATION						
Output Voltage Accuracy	-	I _{OUT} = 0mA, PWM mode	-2	-	+2	%
		I _{OUT} = 1mA, PFM mode	-3	-	+4	%
FB Pin Voltage Regulation	V _{FB}	-	0.788	0.80	0.812	V
FB Pin Bias Current	I _{FB}	-	-	-	0.2	μA
Line Regulation, PWM Mode	$\Delta V_{OUT} / \Delta V_{IN}$	I _{OUT} = 500mA, MODE = GND, V _{IN} step from 2.3V to 4.8V	-	±0.005	-	mV/mV
Load Regulation, PWM Mode	$\Delta V_{OUT} / \Delta I_{OUT}$	V _{IN} = 3.7V, MODE = GND, I _{OUT} step from 0mA to 500mA	-	±0.005	-	mV/mA
Line Regulation, PFM Mode	$\Delta V_{OUT} / \Delta V_{IN}$	I _{OUT} = 100mA, MODE = V _{IN} , V _{IN} step from 2.3V to 4.8V	-	±12.5	-	mV/V
Load Regulation, PFM Mode	$\Delta V_{OUT} / \Delta I_{OUT}$	V _{IN} = 3.7V, MODE = V _{IN} , I _{OUT} step from 0mA to 100mA	-	±0.4	-	mV/mA
Output Voltage Clamp	V _{CLAMP}	Rising	5.25	-	5.95	V
Output Voltage Clamp Hysteresis	-	-	-	400	-	mV
DC/DC SWITCHING SPECIFICATIONS						
Oscillator Frequency	f _{SW}	-	2.4	2.6	2.9	MHz
Minimum On Time	t _{ONMIN}	-	-	80	-	ns
LX Pin Leakage Current	I _{NFETLEAK}	-	-0.5	-	+0.5	μA

Analog Specifications VIN = PVIN = EN = 3.6V, VOUT = 5V, L1 = 1μH, C1 = 22μF, C2 = 2 x 22μF, TA = +25°C. **Boldface limits apply over the operating temperature range, -40°C to +85°C and input voltage range (1.8V to 4.8V). (Continued)**

PARAMETER	SYMBOL	TEST CONDITIONS	MIN (Note 7)	TYP	MAX (Note 7)	UNITS
SOFT-START and SOFT DISCHARGE						
Soft-start Time	t _{SS}	Time from when EN signal asserts to when output voltage ramp starts.	-	1	-	ms
		Time from when output voltage ramp starts to when output voltage reaches 95% of its nominal value. V _{IN} = 2V, I _{OUT} = 200mA	-	2	-	ms
VOUT Soft-Discharge ON-Resistance	R _{DISCHG}	EN < V _{IL}	-	120	-	Ω
POWER MOSFET						
P-Channel MOSFET ON-Resistance	R _{DSON_P}	I _{OUT} = 200mA	-	90	-	mΩ
N-Channel MOSFET ON-Resistance	R _{DSON_N}	I _{OUT} = 200mA	-	75	-	mΩ
P-Channel MOSFET Peak Current Limit	I _{PK_LMT}	-	3.7	4.2	4.7	A
PFM/PWM TRANSITION						
Load Current Threshold, PFM to PWM	-	-	-	200	-	mA
Load Current Threshold, PWM to PFM	-	-	-	75	-	mA
External Synchronization Frequency Range	-	-	2.75		3.25	MHz
Thermal Shutdown	-	-	-	150	-	°C
Thermal Shutdown Hysteresis	-	-	-	35	-	°C
LOGIC INPUTS						
Input Leakage	I _{LEAK}	-	-	0.03	0.5	μA
Input HIGH Voltage	V _{IH}	-	1.4	-	-	V
Input LOW Voltage	V _{IL}	-	-	-	0.4	V

NOTES:

- Parameters with MIN and/or MAX limits are 100% tested at +25°C, unless otherwise specified. Temperature limits established by characterization and are not production tested.
- Quiescent current measurements are taken when the output is not switching.

Typical Performance Curves

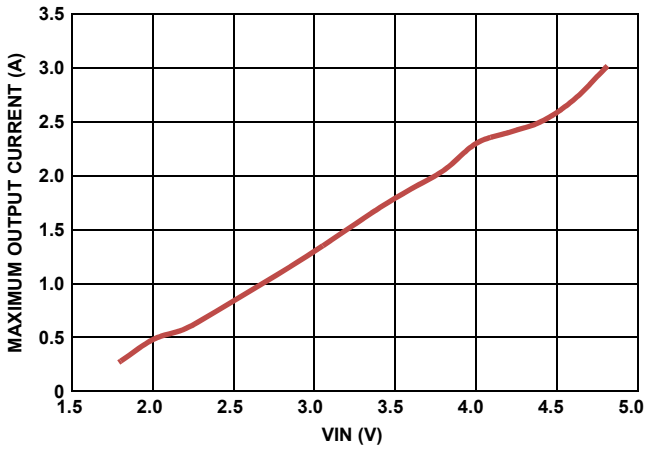

FIGURE 3. MAXIMUM OUTPUT CURRENT vs INPUT VOLTAGE ($V_{OUT} = 5V$)

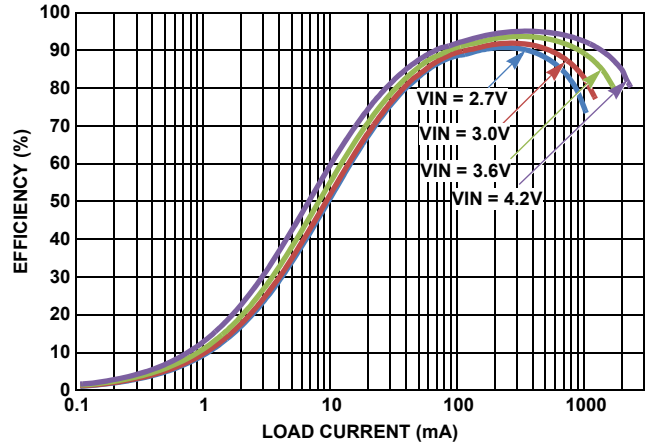

FIGURE 4. EFFICIENCY vs LOAD CURRENT ($V_{OUT} = 5V$, MODE = LOW, $T_A = +25^\circ C$)

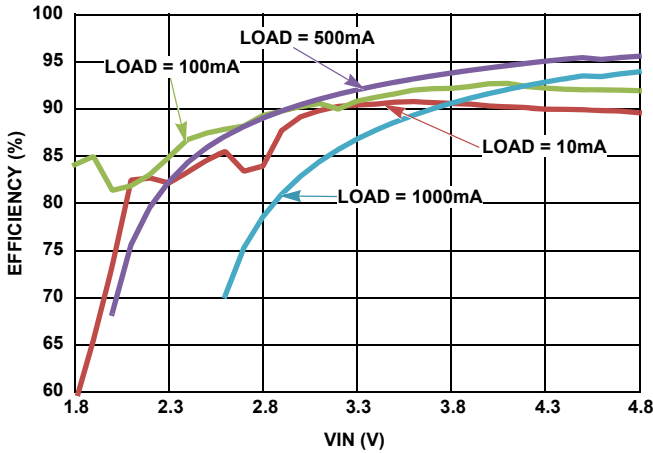

FIGURE 5. EFFICIENCY vs INPUT VOLTAGE (MODE = HIGH, $T_A = +25^\circ C$)

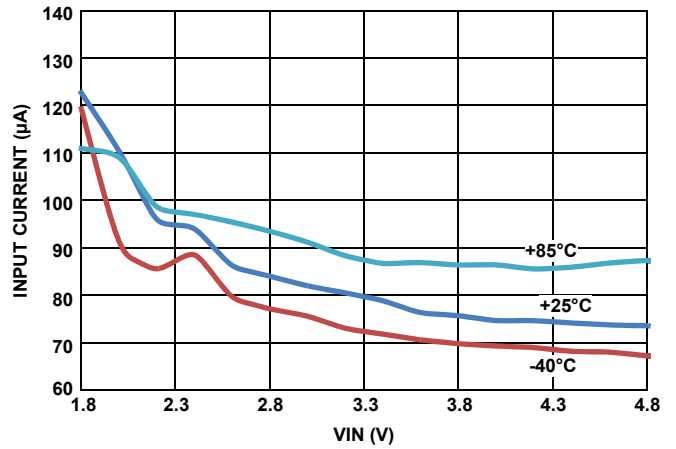

FIGURE 6. INPUT CURRENT vs INPUT VOLTAGE (MODE = HIGH)

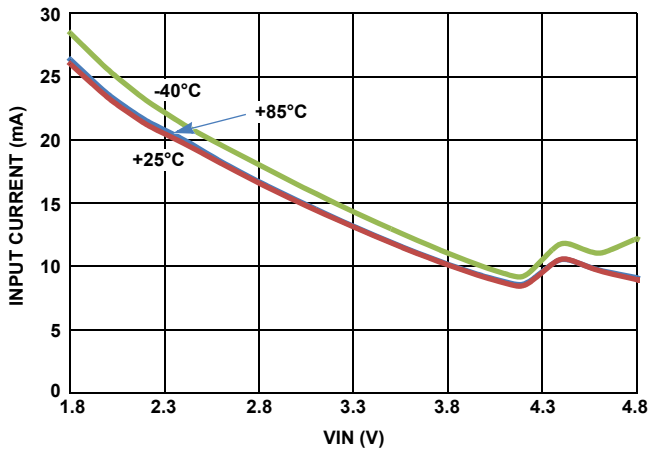

FIGURE 7. INPUT CURRENT vs INPUT VOLTAGE (MODE = LOW)

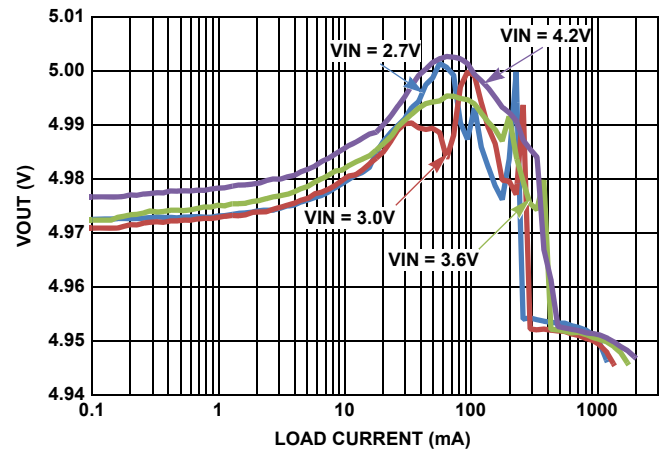

FIGURE 8. OUTPUT VOLTAGE vs LOAD CURRENT (MODE = HIGH, $T_A = +25^\circ C$)

Typical Performance Curves (Continued)

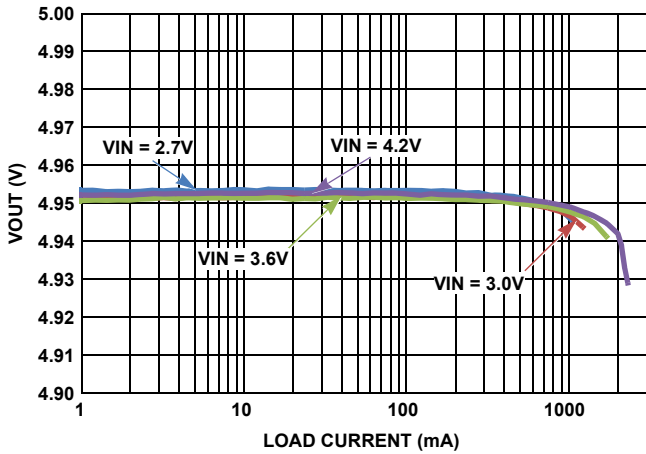

FIGURE 9. OUTPUT VOLTAGE vs LOAD CURRENT (MODE = LOW, $T_A = +25^\circ\text{C}$)

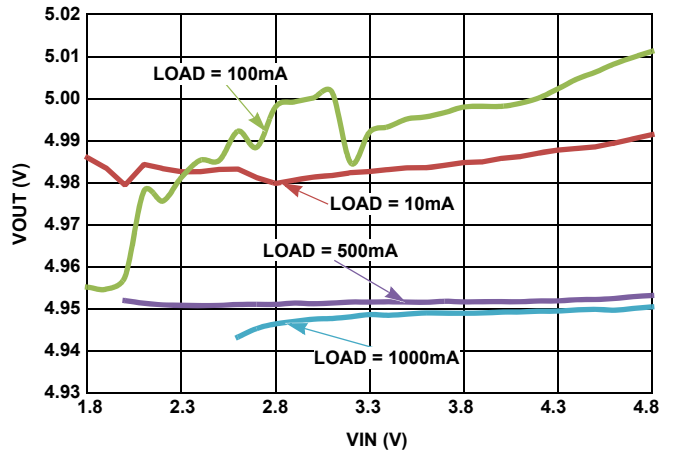

FIGURE 10. OUTPUT VOLTAGE vs INPUT VOLTAGE (MODE = HIGH, $T_A = +25^\circ\text{C}$)

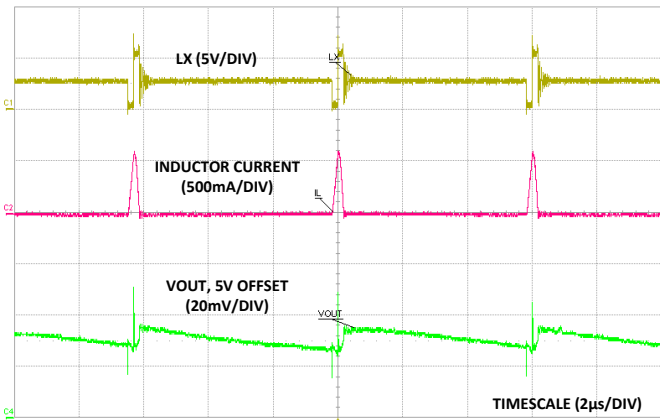

FIGURE 11. PFM MODE OPERATION ($V_{IN} = 3.6\text{V}$, $V_{OUT} = 5\text{V}$, 10mA LOAD)



FIGURE 12. PWM MODE OPERATION ($V_{IN} = 3.6\text{V}$, $V_{OUT} = 5\text{V}$, 200mA LOAD)

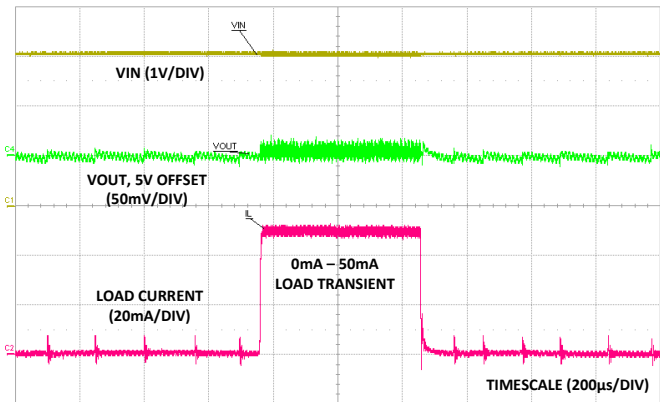

FIGURE 13. LOAD TRANSIENT ($V_{IN} = 3.0\text{V}$, $V_{OUT} = 5\text{V}$)

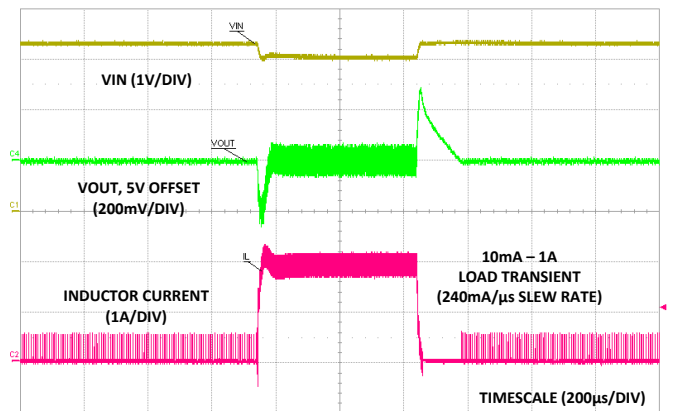

FIGURE 14. LOAD TRANSIENT ($V_{IN} = 3.0\text{V}$, $V_{OUT} = 5\text{V}$)

Typical Performance Curves (Continued)

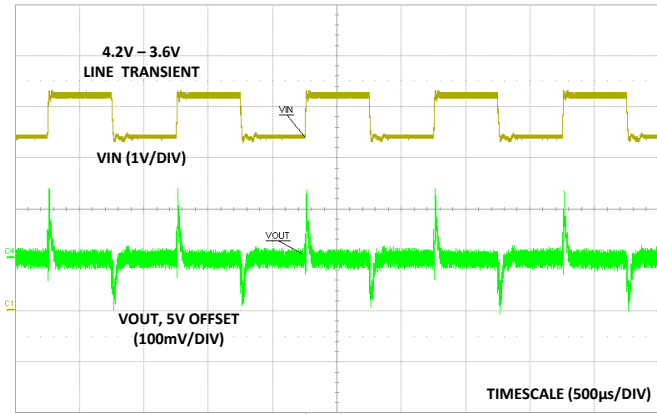

FIGURE 15. LINE TRANSIENT ($V_{OUT} = 5V$)

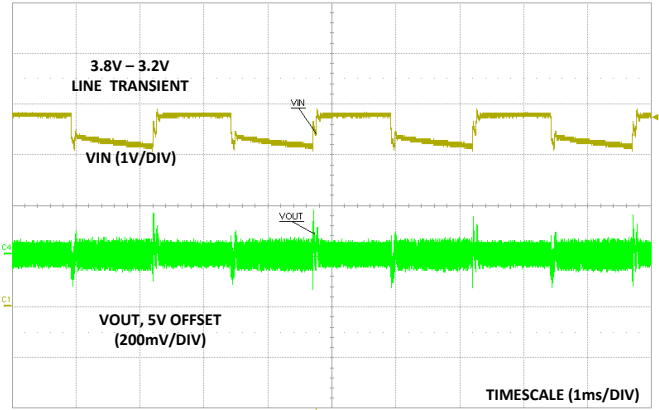

FIGURE 16. LINE TRANSIENT ($V_{OUT} = 5V$)

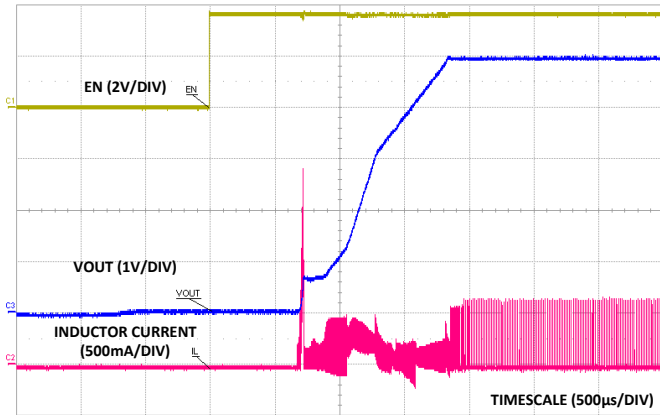

FIGURE 17. START-UP WITH NO LOAD ($V_{IN} = 3.6V$, $V_{OUT} = 5V$)

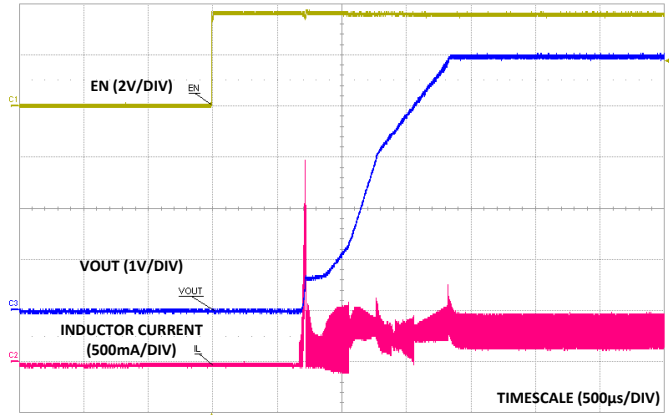

FIGURE 18. START-UP WITH 25Ω ($V_{IN} = 3.6V$, $V_{OUT} = 5V$)

Functional Description

Functional Overview

Refer to the “Block Diagram” on page 2. The ISL91117 implements a complete boost switching regulator, with PWM controller, internal switches, references, protection circuitry, and control inputs.

Internal Supply and References

Referring to the “Block Diagram” on page 2, the ISL91117 provides two power input pins. The PVIN pin supplies input power to the DC/DC converter, while the VIN pin provides the operating voltage source required for stable V_{REF} generation. Separate ground pins (GND and PGND) are provided to avoid problems caused by ground shift due to the high switching currents.

Enable Input

A master enable pin EN allows the device to be enabled. Driving the EN pin LOW invokes a power-down mode, where most internal device functions, including input and output power-good detection, are disabled.

Soft Discharge

When the device is disabled by driving EN LOW, an internal resistor between VOUT and GND is activated. This internal resistor has typical 120 Ω resistance.

POR Sequence and Soft-start

Bringing the EN pin HIGH allows the device to power-up. A number of events occur during the start-up sequence. The internal voltage reference powers up, and stabilizes. The device then starts operating. There is a typical 1ms delay between assertion of the EN pin and the start of switching regulator soft-start ramp.

The soft-start feature minimizes output voltage overshoot and input in-rush currents. During soft-start, the reference voltage is ramped up to provide a ramping VOUT voltage. While the output voltage is lower than approximately 20% of the target output voltage, switching frequency is reduced to a fraction of the normal switching frequency to aid in producing low duty cycles necessary to avoid input in-rush current spikes. Once the output voltage exceeds that threshold, switching frequency is increased to its nominal value.

The soft-start time is typically 3ms. Increasing the load current will increase these typical soft-start times.

Short Circuit Protection

The ISL91117 provides short-circuit protection by monitoring the feedback voltage. When feedback voltage is sensed to be lower than a certain threshold, the PWM oscillator frequency is reduced in order to protect the device from damage. The P-Channel MOSFET peak current limit remains active during this state.

Undervoltage Lockout

The undervoltage lockout (UVLO) feature prevents abnormal operation in the event that the supply voltage is too low to guarantee proper operation. When the VIN voltage falls below the UVLO threshold, the regulator is disabled.

Thermal Shutdown

A built-in thermal protection feature protects the ISL91117 if the die temperature reaches +150 °C (typical). At this die temperature, the regulator is completely shut down. The die temperature continues to be monitored in this thermal-shutdown mode. When the die temperature falls to +125 °C (typical), the device will resume normal operation.

When exiting thermal shutdown, the ISL91117 will execute its soft-start sequence.

External Synchronization

An external sync feature is provided. Applying a clock signal with a frequency between 2.75MHz and 3.25MHz at the MODE input, forces the ISL91117 to synchronize to this external clock. The MODE input supports standard logic levels.

PWM Operation

The control scheme of the device is based on the peak current mode control, and the control loop is compensated internally. The peak current of the N-channel MOSFET switch is sensed to limit the maximum current flowing through the switch and the inductor.

The control circuit includes ramp generator, slope compensator, error amplifier, PWM comparator (see “Block Diagram” on page 2). The ramp signal is derived from the inductor current. This ramp signal is then compared to the error amplifier output to generate the PWM gating signals for driving both N-channel and P-channel MOSFETs. The PWM operation is initialized by the clock from the internal oscillator (typical 2.6MHz). The N-channel MOSFET is turned ON at the beginning of a PWM cycle, the P-channel MOSFET remains OFF, and the current starts ramping up. When the sum of the ramp and the slope compensator output reaches the error amplifier output voltage, the PWM comparator outputs a signal to turn OFF the N-channel MOSFET. Here, both MOSFETs remain OFF during the dead-time interval, and then the P-channel MOSFET is turned ON and remains ON until the end of this PWM cycle. During this time, the inductor current ramps down until the next clock. At this point, following a short dead time, the N-channel MOSFET is again turned ON, repeating as previously described.

PFM Operation

The boost converter enters the PFM mode of operation under light load conditions. When the inductor current is sensed to cross zero, the converter enters PFM mode. In this mode, each pulse cycle is still synchronized by the PWM clock. The N-channel MOSFET is turned ON at the rising edge of the clock and turned OFF when the inductor peak current reaches a certain current limit. Then the P-channel MOSFET is turned ON, and it stays ON until the inductor current goes to zero. Subsequently, both N-channel and P-channel MOSFETs are turned OFF until the next clock cycle starts, at which time the N-channel MOSFET is turned ON again.

In most operating conditions, there will be multiple PFM pulses to charge up the output capacitor. In addition to the inductor current limit for PFM operation, the PFM pulses are also controlled by output voltage. These pulses continue until VOUT has achieved the upper threshold of the PFM hysteretic controller. Switching then stops, and remains stopped until VOUT decays to the lower threshold of the hysteretic PFM controller.

Applications Information

Component Selection

The ISL91117 requires three additional components to program the output voltage. Two external resistors program the output voltage, and a small capacitor is added to improve stability and response.

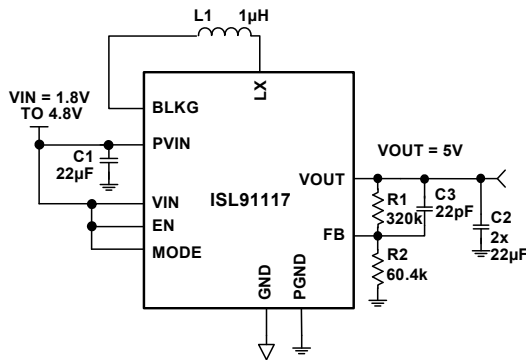

FIGURE 19. TYPICAL APPLICATION

Output Voltage Programming

Setting and controlling the output voltage of the ISL91117 can be accomplished by selecting the external resistor values.

Equation 1 can be used to derive the R1 and R2 resistor values:

$$V_{OUT} = 0.8V \cdot \left(1 + \frac{R1}{R2}\right) \quad (\text{EQ. 1})$$

When designing a PCB, include a GND guard band around the feedback resistor network to reduce noise and improve accuracy and stability. Resistors R1 and R2 should be positioned close to the FB pin.

Feed-Forward Capacitor Selection

A small capacitor (C3 in Figure 19) in parallel with resistor R1 is required to provide the specified load and line regulation. The suggested value of this capacitor is 22pF for R1 = 320kΩ. An NPO type capacitor is recommended.

Inductor Selection

An inductor with high frequency core material (e.g., ferrite core) should be used to minimize core losses and provide good efficiency. The inductor must be able to handle the peak switching currents without saturating.

A 1µH inductor with ≥4A saturation current rating is recommended. Select an inductor with low DCR to provide good

efficiency. In applications where radiated noise must be minimized, a toroidal or shielded inductor can be used.

TABLE 1. INDUCTOR VENDOR INFORMATION

MANUFACTURER	SERIES	WEBSITE
Coilcraft	XFL4020-102ME	www.coilcraft.com
Murata	LQH5BPN1R0NT0	www.murata.com

PVIN and VOUT Capacitor Selection

The input and output capacitors should be ceramic X5R type with low ESL and ESR. The recommended input capacitor value is 22µF. The recommended VOUT capacitor value is 2x22µF or 47µF.

TABLE 2. CAPACITOR VENDOR INFORMATION

MANUFACTURER	SERIES	WEBSITE
AVX	X5R	www.avx.com
Murata	X5R	www.murata.com
Taiyo Yuden	X5R	www.t-yuden.com
TDK	X5R	www.tdk.com

Recommended PCB Layout

Correct PCB layout is critical for proper operation of the ISL91117. The input and output capacitors should be positioned as closely to the IC as possible. The ground connections of the input and output capacitors should be kept as short as possible, and should be on the component layer to avoid problems that are caused by high switching currents flowing through PCB vias.

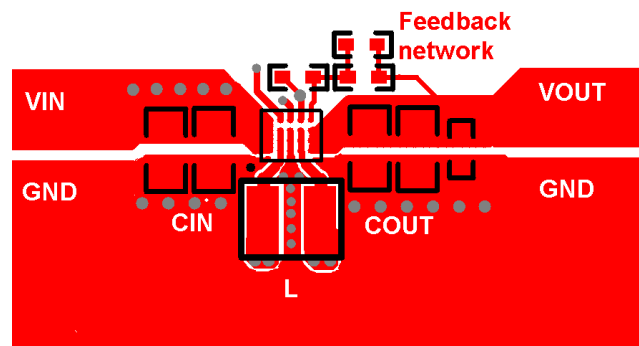

FIGURE 20. RECOMMENDED LAYOUT

Revision History

The revision history provided is for informational purposes only and is believed to be accurate, but not warranted. Please go to web to make sure you have the latest revision.

DATE	REVISION	CHANGE
Nov 16, 2023	3.01	Removed ISL9117II7 device information from datasheet. Removed Related Literature and About Intersil sections. Updated Ordering Information table formatting.
March 7, 2014	3.00	Updated Related Literature. Figure 18 on page 8 Title changed from START-UP WITH NO LOAD (VIN = 3.6V, VOUT = 5V) to START-UP WITH 25Ω (VIN = 3.6V, VOUT = 5V).
February 4, 2014	2.00	Initial Release.

Package Outline Drawing

W4x5.20F

20 BALL WAFER LEVEL CHIP SCALE PACKAGE (WLCSP 0.4mm PITCH)

Rev 0, 5/13

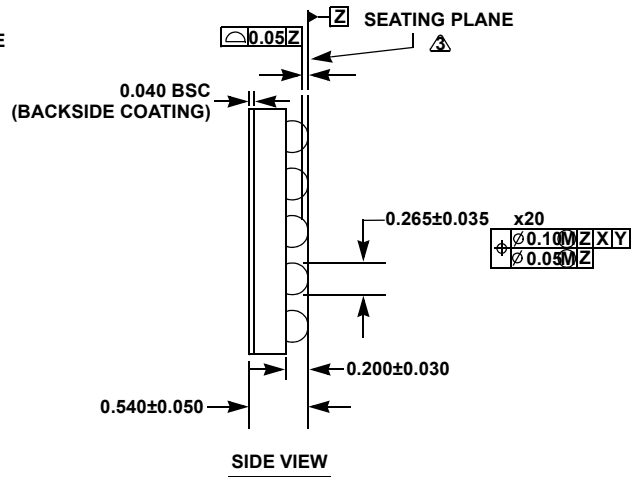
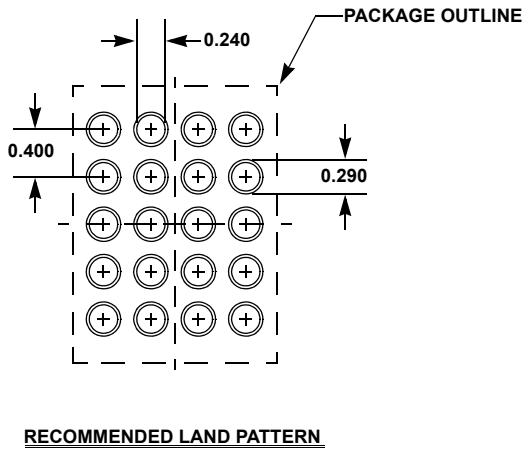
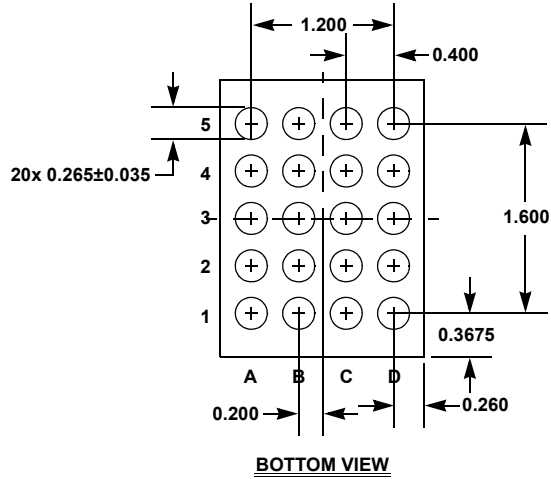
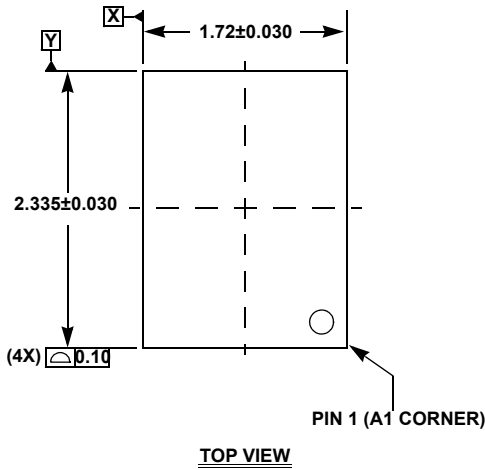

NOTES:

1. Dimensions and tolerance per ASME Y 14.5M - 1994.
2. Dimension is measured at the maximum bump diameter parallel to primary datum **Z**.
3. Primary datum **Z** and seating plane are defined by the spherical crowns of the bump.
4. Bump position designation per JESD 95-1, SPP-010.
5. There shall be a minimum clearance of 0.10mm between the edge of the bump and the body edge.

IMPORTANT NOTICE AND DISCLAIMER

RENESAS ELECTRONICS CORPORATION AND ITS SUBSIDIARIES (“RENESAS”) PROVIDES TECHNICAL SPECIFICATIONS AND RELIABILITY DATA (INCLUDING DATASHEETS), DESIGN RESOURCES (INCLUDING REFERENCE DESIGNS), APPLICATION OR OTHER DESIGN ADVICE, WEB TOOLS, SAFETY INFORMATION, AND OTHER RESOURCES “AS IS” AND WITH ALL FAULTS, AND DISCLAIMS ALL WARRANTIES, EXPRESS OR IMPLIED, INCLUDING, WITHOUT LIMITATION, ANY IMPLIED WARRANTIES OF MERCHANTABILITY, FITNESS FOR A PARTICULAR PURPOSE, OR NON-INFRINGEMENT OF THIRD PARTY INTELLECTUAL PROPERTY RIGHTS.

These resources are intended for developers skilled in the art designing with Renesas products. You are solely responsible for (1) selecting the appropriate products for your application, (2) designing, validating, and testing your application, and (3) ensuring your application meets applicable standards, and any other safety, security, or other requirements. These resources are subject to change without notice. Renesas grants you permission to use these resources only for development of an application that uses Renesas products. Other reproduction or use of these resources is strictly prohibited. No license is granted to any other Renesas intellectual property or to any third party intellectual property. Renesas disclaims responsibility for, and you will fully indemnify Renesas and its representatives against, any claims, damages, costs, losses, or liabilities arising out of your use of these resources. Renesas' products are provided only subject to Renesas' Terms and Conditions of Sale or other applicable terms agreed to in writing. No use of any Renesas resources expands or otherwise alters any applicable warranties or warranty disclaimers for these products.

(Disclaimer Rev.1.0 Mar 2020)

Corporate Headquarters

TOYOSU FORESIA, 3-2-24 Toyosu,
Koto-ku, Tokyo 135-0061, Japan
www.renesas.com

Contact Information

For further information on a product, technology, the most up-to-date version of a document, or your nearest sales office, please visit:
www.renesas.com/contact/

Trademarks

Renesas and the Renesas logo are trademarks of Renesas Electronics Corporation. All trademarks and registered trademarks are the property of their respective owners.