

Low Power Off-Line Digital Green-Mode PWM Controller

1 Description

The iW1676 is a high performance AC/DC power supply controller which uses digital control technology to build peak current mode PWM flyback power supplies. The device directly drives a power BJT and operates in quasi-resonant mode to provide high efficiency along with a number of key built-in protection features while minimizing the external component count, simplifying EMI design and lowering the total bill of material cost. The iW1676 removes the need for secondary feedback circuit while achieving excellent line and load regulation. It also eliminates the need for loop compensation components while maintaining stability over all operating conditions. Pulse-by-pulse waveform analysis allows for a loop response that is much faster than traditional solutions, resulting in improved dynamic load response, for both one-time and repetitive load transients. The built-in power limit function enables optimized transformer design in universal off-line applications and allows for a wide input voltage range.

Dialog's innovative proprietary technology ensures that with low system cost, power supplies built with the iW1676 can achieve both highest average efficiency, less than 30mW no-load power consumption and fast dynamic load response in a compact form factor.

2 Features

- No-load power consumption < 30mW at 230V_{AC} with typical application circuit (5-star rating)
- Fast dynamic load response for both one-time and repetitive load transients
- Very tight constant voltage and constant current regulation over entire operating range
- Primary-side feedback eliminates optoisolators and simplifies design
- 64kHz PWM switching frequency
- Ultra-low start-up current (1.7μA typical)
- **EZ-EMI**[™] design enhances manufacturability
- Intrinsically low common mode noise
- Adaptive multi-mode PWM/PFM control improves efficiency
- Quasi-resonant operation for highest overall efficiency
- Direct drive of low-cost BJT switch
- Dynamic base current control
- No external compensation components required
- Complies with EPA 2.0 energy-efficiency specifications with ample margin
- Built-in soft start
- Built-in short circuit protection and output overvoltage protection
- Built-in current sense resistor short circuit protection
- No audible noise over entire operating range

3 Applications

- Compact low power AC/DC adapter/chargers for cell phones, PDAs, digital still cameras
- Linear AC/DC replacement

Low Power Off-Line Digital Green-Mode PWM Controller

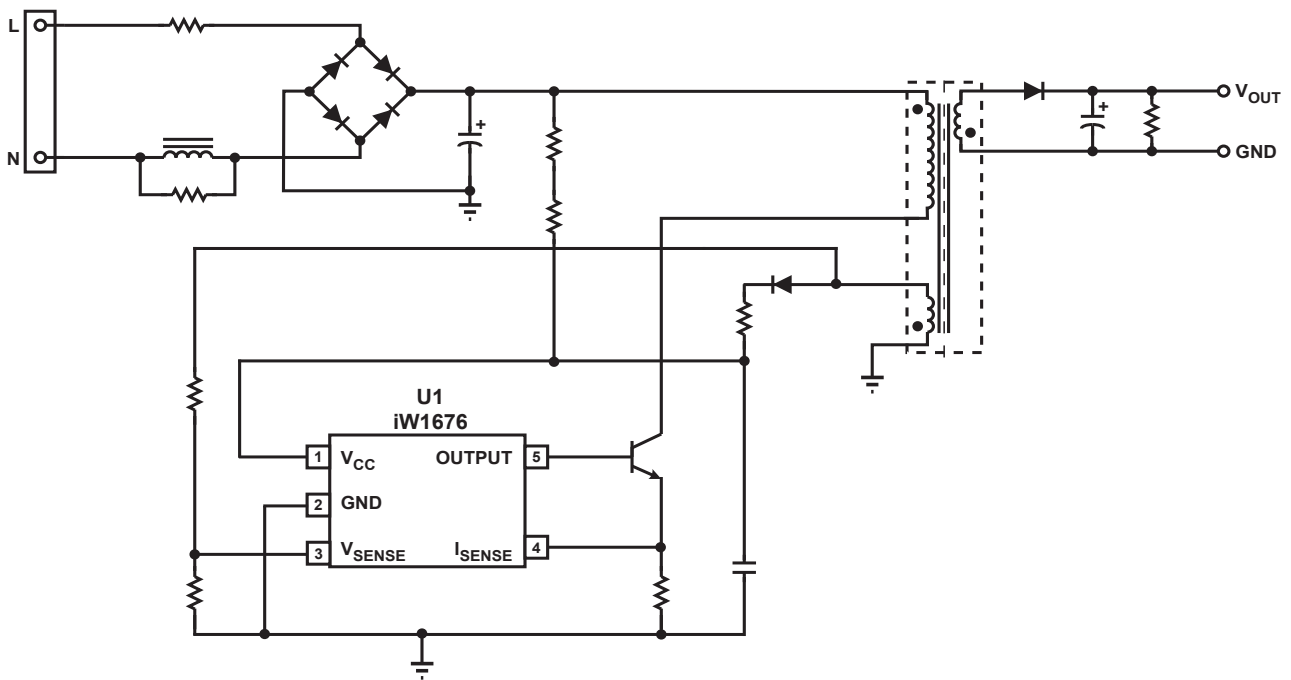
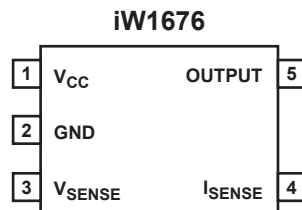

Figure 3.1 : iW1676 Typical Application Circuit (Achieving < 30mW No-load Power Consumption)

Low Power Off-Line Digital Green-Mode PWM Controller

4 Pinout Description



Pin #	Name	Type	Pin Description
1	V_{CC}	Power Input	Power supply for control logic.
2	GND	Ground	Ground.
3	V_{SENSE}	Analog Input	Auxiliary voltage sense (used for primary regulation).
4	I_{SENSE}	Analog Input	Primary current sense. Used for cycle-by-cycle peak current control and limit.
5	OUTPUT	Output	Base drive for BJT.

Low Power Off-Line Digital Green-Mode PWM Controller

5 Absolute Maximum Ratings

Absolute maximum ratings are the parameter values or ranges which can cause permanent damage if exceeded. For maximum safe operating conditions, refer to Electrical Characteristics in Section 6.

Parameter	Symbol	Value	Units
DC supply voltage range (pin 1, $I_{CC} = 20\text{mA max}$)	V_{CC}	-0.3 to 18.0	V
Continuous DC supply current at V_{CC} pin ($V_{CC} = 15\text{V}$)	I_{CC}	20	mA
Output (pin 5)		-0.3 to 4.0	V
V_{SENSE} input (pin 3, $I_{Vsense} \leq 10\text{mA}$)		-0.7 to 4.0	V
I_{SENSE} input (pin 4)		-0.3 to 4.0	V
Maximum junction temperature	T_{JMAX}	150	°C
Storage temperature	T_{STG}	-65 to 150	°C
Thermal Resistance Junction-to-Ambient	θ_{JA}	190	°C/W
ESD rating per JEDEC JS-001-2017		$\pm 2,000$	V
Latch-Up test per JESD78E		± 100	mA

Low Power Off-Line Digital Green-Mode PWM Controller

6 Electrical Characteristics

$V_{CC} = 12V$, $-40^{\circ}C \leq T_A \leq 85^{\circ}C$, unless otherwise specified

Parameter	Symbol	Test Conditions	Min	Typ	Max	Unit
V_{SENSE} SECTION (Pin 3)						
Input leakage current	I_{BVS}	$V_{SENSE} = 2V$			1	μA
Nominal voltage threshold	$V_{SENSE(NOM)}$	$T_A = 25^{\circ}C$, negative edge	1.518	1.533	1.548	V
Output OVP threshold -01 (Note 1)	$V_{SENSE(MAX)}$	$T_A = 25^{\circ}C$, negative edge Load = 100 %		1.926		V
I_{SENSE} SECTION (Pin 4)						
Overcurrent threshold	V_{OCP}		1.11	1.15	1.19	V
I _{SENSE} regulation upper limit (Note 1)	$V_{IPK(HIGH)}$			1.0		V
I _{SENSE} regulation lower limit (Note 1)	$V_{IPK(LOW)}$			0.23		V
Input leakage current	I_{LK}	$I_{SENSE} = 1.0V$			1	μA
OUTPUT SECTION (Pin 5)						
Output low level ON-resistance	$R_{DS(ON)LO}$	$I_{SINK} = 5mA$		1	3	Ω
Switching frequency (Note 2)	f_{SW}	> 50% load		64		kHz
V_{CC} SECTION (Pin 1)						
Maximum operating voltage (Note 1)	$V_{CC(MAX)}$				16	V
Start-up threshold	$V_{CC(ST)}$	V_{CC} rising	10.0	11.0	12.0	V
Undervoltage lockout threshold	$V_{CC(UVL)}$	V_{CC} falling	3.8	4.0	4.2	V
Start-up Current	$I_{IN(ST)}$	$V_{CC} = 10V$	1.0	1.7	3.0	μA
Quiescent current	I_{CCQ}	$V_{CC} = 14V$, without driver switching		2.7	4.0	mA
No-load operating current (Note 1 & 3)	I_{CC_NL}	No-load operation in DDPWM mode	0.29	0.42	0.57	mA
Zener breakdown voltage	V_{ZB}	Zener current = 5mA $T_A = 25^{\circ}C$	18.5	19.5	20.5	V

Notes:

Note 1. These parameters are not 100% tested. They are guaranteed by design and characterization.

Note 2. Operating frequency varies based on the load conditions, see Section 9.6 for more details.

Note 3. See Sections 9.6 and 9.7 for details.

Low Power Off-Line Digital Green-Mode PWM Controller

7 Typical Performance Characteristics

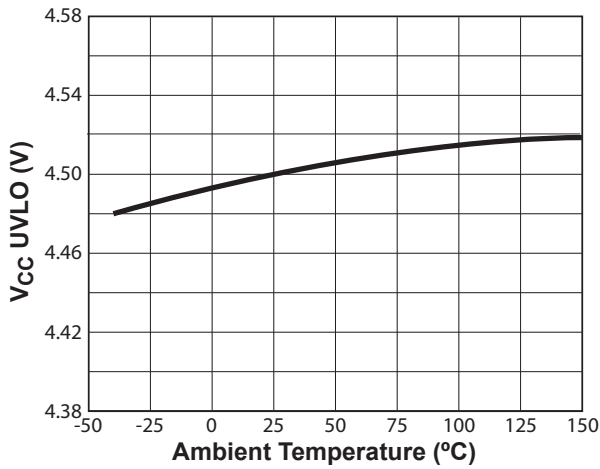

Figure 7.1 : V_{CC} UVLO vs. Temperature

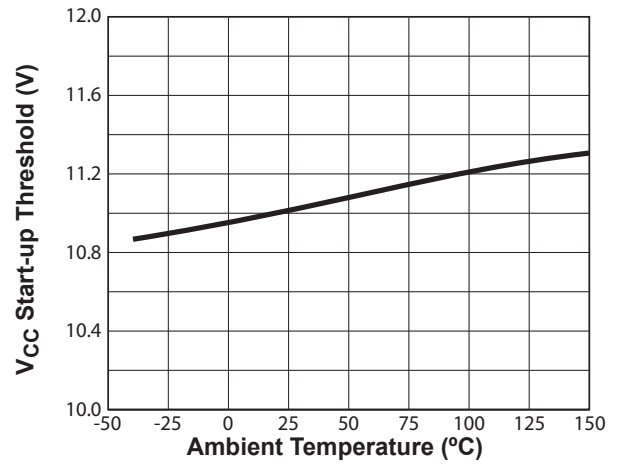

Figure 7.2 : Start-Up Threshold vs. Temperature

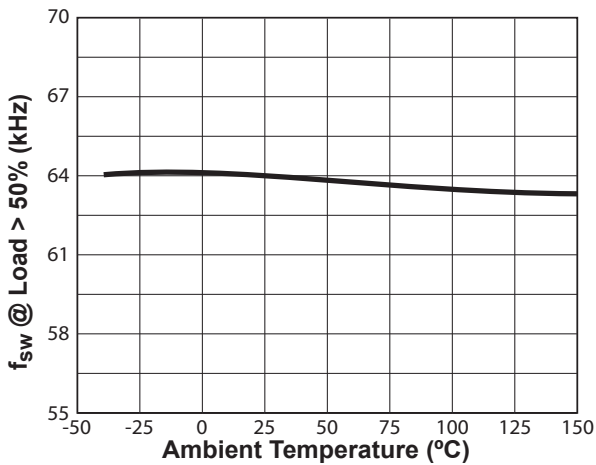

Figure 7.3 : Switching Frequency vs. Temperature¹

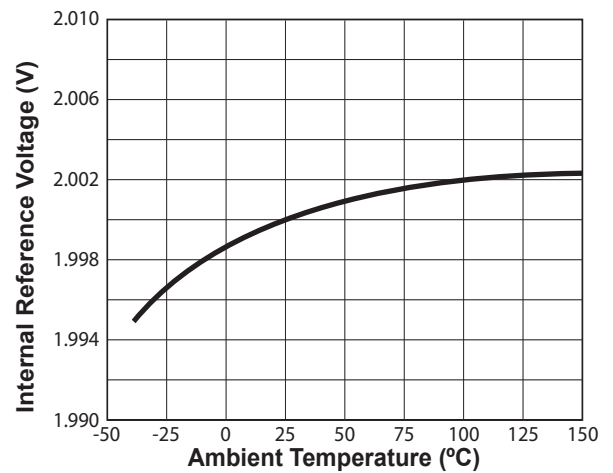

Figure 7.4 : Internal Reference vs. Temperature

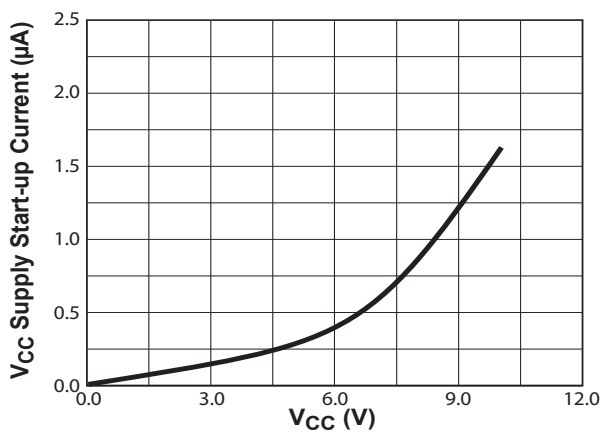

Figure 7.5 : V_{CC} vs. V_{CC} Supply Start-up Current

Notes:

Note 1. Operating frequency varies based on the load conditions, see Section 9.6 for more details.

Low Power Off-Line Digital Green-Mode PWM Controller

8 Functional Block Diagram

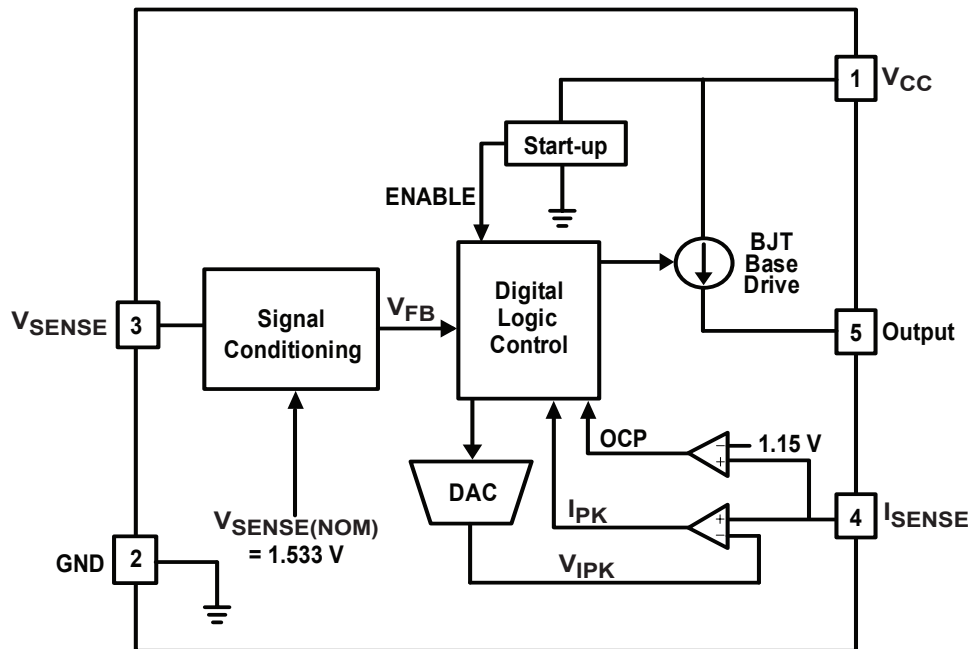

Figure 8.1 : iW1676 Functional Block Diagram

Low Power Off-Line Digital Green-Mode PWM Controller

9 Theory of Operation

The iW1676 is a digital controller which uses a new, proprietary primary-side control technology to eliminate the optoisolated feedback and secondary regulation circuits required in traditional designs. This results in a low-cost solution for low power AC/DC adapters. The core PWM processor uses fixed-frequency Discontinuous Conduction Mode (DCM) operation at higher power levels and switches to variable frequency operation at light loads to maximize efficiency. Furthermore, Dialog's digital control technology enables fast dynamic response, tight output regulation, and full featured circuit protection with primary-side control.

Referring to the block diagram in Figure 8.1, the digital logic control block generates the switching on-time and off-time information based on the output voltage and current feedback signal and provides commands to dynamically control the external BJT base current. The system loop is automatically compensated internally by a digital error amplifier. Adequate system phase margin and gain margin are guaranteed by design and no external analog components are required for loop compensation. The iW1676 uses an advanced digital control algorithm to reduce system design time and increase reliability.

Furthermore, accurate secondary constant-current operation is achieved without the need for any secondary-side sense and control circuits.

The iW1676 uses adaptive multi-mode PWM/PFM control to dynamically change the BJT switching frequency for efficiency, EMI, and power consumption optimization. In addition, it achieves unique BJT quasi-resonant switching to further improve efficiency and reduce EMI. Built-in single-point fault protection features include overvoltage protection (OVP), output short circuit protection (SCP), over current protection (OCP), and I_{SENSE} fault detection. In particular, it ensures that power supplies built with the iW1676 can meet 5-star energy saving requirement and achieve fast dynamic load response.

Dialog's digital control scheme is specifically designed to address the challenges and trade-offs of power conversion design. This innovative technology is ideal for balancing new regulatory requirements for green mode operation with more practical design considerations such as lowest possible cost, smallest size and high performance output control.

9.1 Pin Detail

Pin 1 – V_{CC}

Power supply for the controller during normal operation. The controller will start up when V_{CC} reaches 11.0V (typical) and will shut-down when the V_{CC} voltage is 4.0V (typical). A decoupling capacitor of 0.1 μ F or so should be connected between the V_{CC} pin and GND.

Pin 2 – GND

Ground.

Pin 3 – V_{SENSE}

Sense signal input from auxiliary winding. This provides the secondary voltage feedback used for output regulation.

Pin 4 – I_{SENSE}

Primary current sense. Used for cycle-by-cycle peak current control and limit.

Pin 5 – OUTPUT

Base drive for the external power BJT switch.

Low Power Off-Line Digital Green-Mode PWM Controller

9.2 Start-up

Prior to start-up, the V_{CC} pin is charged typically through start-up resistors. When V_{CC} bypass capacitor is fully charged to a voltage higher than the start-up threshold $V_{CC(ST)}$, the ENABLE signal becomes active to enable the control logic, and the iW1676 commences soft start function. An adaptive soft-start control algorithm is applied at startup state, during which the initial output pulses will be small and gradually get larger until the full pulse width is achieved. The peak current is limited cycle by cycle by the I_{PEAK} comparator.

If at any time the V_{CC} voltage drops below $V_{CC(UVL)}$ threshold then all the digital logic is reset. At this time ENABLE signal becomes low and the V_{CC} capacitor is charged up again towards the start-up threshold to initiate a new soft-start process.

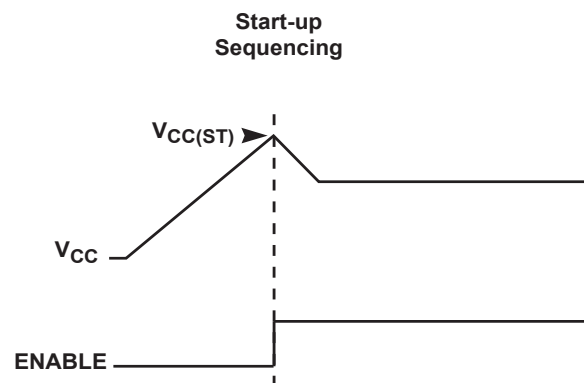

Figure 9.1 : Start-up Sequencing Diagram

9.3 Understanding Primary Feedback

Figure 9.2 illustrates a simplified flyback converter. When the switch Q1 conducts during $t_{ON}(t)$, the current $i_g(t)$ is directly drawn from rectified sinusoid $v_g(t)$. The energy $E_g(t)$ is stored in the magnetizing inductance L_M . The rectifying diode D1 is reverse biased and the load current I_O is supplied by the secondary capacitor C_O . When Q1 turns off, D1 conducts and the stored energy $E_g(t)$ is delivered to the output.

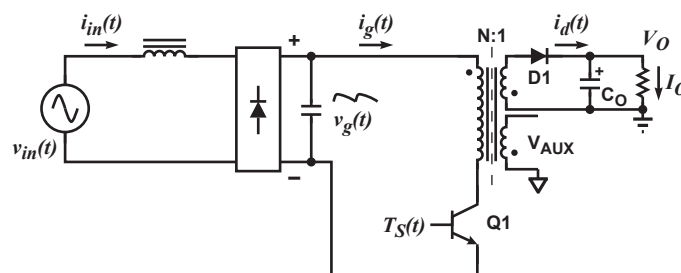

Figure 9.2 : Simplified Flyback Converter

In order to tightly regulate the output voltage, the information about the output voltage and load current need to be accurately sensed. In the DCM flyback converter, this information can be read via the auxiliary winding or the primary magnetizing inductance (L_M). During the Q1 on-time, the load current is supplied from the output filter capacitor C_O . The voltage across L_M is $v_g(t)$, assuming the voltage dropped across Q1 is zero. The current in Q1 ramps up linearly at a rate of:

Low Power Off-Line Digital Green-Mode PWM Controller

$$\frac{di_g(t)}{dt} = \frac{v_g(t)}{L_M} \quad (9.1)$$

At the end of on-time, the current has ramped up to:

$$i_{g_peak}(t) = \frac{v_g(t) \times t_{ON}}{L_M} \quad (9.2)$$

This current represents a stored energy of:

$$E_g = \frac{L_M}{2} \times i_{g_peak}(t)^2 \quad (9.3)$$

When Q1, turns off at t_O , $i_g(t)$ in L_M forces a reversal of polarities on all windings. Ignoring the communication-time caused by the leakage inductance L_K at the instant of turn-off t_O , the primary current transfers to the secondary at a peak amplitude of:

$$i_d(t) = \frac{N_P}{N_S} \times i_{g_peak}(t) \quad (9.4)$$

Assuming the secondary winding is master, and the auxiliary winding is slave,

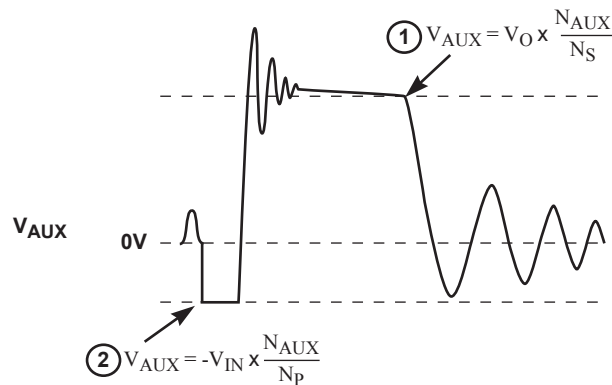

Figure 9.3 : Auxiliary Voltage Waveforms

the auxiliary voltage is given by:

$$V_{AUX} = \frac{N_{AUX}}{N_S} (V_O + \Delta V) \quad (9.5)$$

and reflects the output voltage as shown in Figure 9.3.

The voltage at the load differs from the secondary voltage by a diode drop and IR losses. Thus, if the secondary voltage is always read at a constant secondary current, the difference between the output voltage and the secondary voltage will be a fixed ΔV . Furthermore, if the voltage can be read when the secondary current is small, ΔV will also be small. With the iW1676, ΔV can be ignored.

The real-time waveform analyzer in the iW1676 reads this information cycle by cycle. The part then generates a feedback voltage V_{FB} . The V_{FB} signal precisely represents the output voltage under most conditions and is used to regulate the output voltage.

Low Power Off-Line Digital Green-Mode PWM Controller

9.4 Constant Voltage Operation

After soft-start has been completed, the digital control block measures the output conditions. It determines output power levels and adjusts the control system according to a light load or heavy load. If this is in the normal range, the device operates in the Constant Voltage (CV) mode, and changes the pulse width (T_{ON}) and off time (T_{OFF}) in order to meet the output voltage regulation requirements.

If no voltage is detected on V_{SENSE} it is assumed that the auxiliary winding of the transformer is either open or shorted and the iW1676 shuts down.

9.5 Constant Current Operation

The constant current (CC mode) is useful in battery charging applications. During this mode of operation the iW1676 will regulate the output current at a constant level regardless of the output voltage, while avoiding continuous conduction mode.

To achieve this regulation the iW1676 senses the load current indirectly through the primary current. The primary current is detected by the I_{SENSE} pin through a resistor from the BJT emitter to ground.

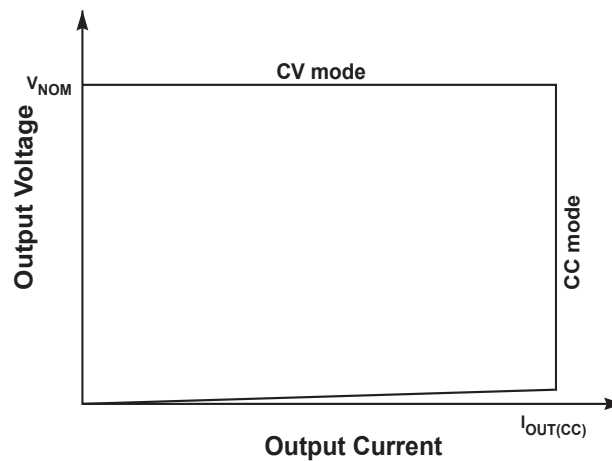

Figure 9.4 : Power Envelope

9.6 Multi-Mode PWM/PFM Control and Quasi-Resonant Switching

The iW1676 uses a proprietary adaptive multi-mode PWM/PFM control to dramatically improve the light-load efficiency and thus the overall average efficiency.

During the constant voltage (CV) operation, the iW1676 normally operates in a pulse-width-modulation (PWM) mode during heavy load conditions. In the PWM mode, the switching frequency keeps around constant. As the output load I_{OUT} is reduced, the on-time t_{ON} is decreased, and the controller adaptively transitions to a pulse-frequency-modulation (PFM) mode. During the PFM mode, the BJT is turned on for a set duration under a given instantaneous rectified AC input voltage, but its off time is modulated by the load current. With a decreasing load current, the off time increases and thus the switching frequency decreases.

When the switching frequency approaches to human ear audio band, the iW1676 transitions to a second level of PWM mode, namely Deep PWM mode (DPWM). During the DPWM mode, the switching frequency keeps around 22kHz in order to avoid audible noise. As the load current is further reduced, the iW1676 transitions to a second level of PFM mode, namely Deep PFM mode (DPFM), which can reduce the switching frequency to a very low level. Although the switching frequency drops across the audible frequency range during the DPFM mode, the output current in the power converter has reduced to an insignificant level in the DPWM mode before transitioning to the DPFM mode.

Low Power Off-Line Digital Green-Mode PWM Controller

Therefore, the power converter practically produces no audible noise, while achieving high efficiency across varying load conditions.

As the load current reduces to very low or no-load condition, the iW1676 transitions from the DPFM to the third level of PWM mode, namely Deep-Deep PWM mode (DDPWM), where the switching frequency is fixed at around 1.9kHz.

The iW1676 also incorporates a unique proprietary quasi-resonant switching scheme that achieves valley-mode turn on for every PWM/PFM switching cycle, during all PFM and PWM modes, and in both CV and CC operations. This unique feature greatly reduces the switching loss and dv/dt across the entire operating range of the power supply. Due to the nature of quasi-resonant switching, the actual switching frequency can vary slightly cycle by cycle, providing the additional benefit of reducing EMI. Together these innovative digital control architecture and algorithms enable the iW1676 to achieve highest overall efficiency and lowest EMI, without causing audible noise over entire operating range.

9.7 Less Than 30mW No-Load Power with Fast Load Transient Response

The iW1676 features the distinctive DDPWM control at no-load conditions to help achieve very low no-load power consumption (< 30mW for typical applications) and meanwhile to ensure fast dynamic load response. The power supply system designs including the pre-load resistor selection should ensure the power supply can stably operate in the DDPWM mode at the steady-state no-load condition. If the pre-load resistor is too small, the no-load power consumption will increase; on the other hand, if it is too large, the output voltage may increase and even cause overvoltage since the switching frequency is fixed at around 1.9kHz. For typical designs, the pre-load resistor is in the range of 5k Ω to 8k Ω .

Aside from the appropriate use of pre-load resistor, the iW1676 enjoys a few other features to bring down no-load power consumption as well. First, the iW1676 implements an intelligent low-power management technique that achieves ultra-low chip operating current at the no-load, typically around 450 μ A. Second, the use of the power switch of BJT instead of MOSFET requires a lower driving voltage, enabling a low UVLO threshold as low as 4.0V (typical). The power supply system design can fully utilize this low UVLO feature to have a low V_{CC} voltage at the no-load operation in order to minimize the no-load power. In addition, the ultra-low start-up current during the ramp-up of V_{CC} towards the start-up threshold $V_{CC(ST)}$ (see Figure 7.5), allows for the use of high resistance start-up resistors to minimize their loss while still retaining reasonable turn-on time. All together these features ensure with the lowest system cost power supplies built with the iW1676 can achieve less than 30mW no-load power consumption at 230V $_{AC}$ input and very tight constant voltage and constant current regulation over the entire operating range including the no-load operation.

While achieving super-low no-load power consumption, the iW1676 implements innovative proprietary digital control technology to intelligently detect any load transient events, and achieve fast dynamic load response for both one-time and repetitive load transients. In particular, for load transients that are demanded in some applications as from absolutely no load to full load, the iW1676 can still guarantee a fast enough response to meet the most stringent requirements, with the no-load operating frequency designed at around 1.9kHz.

9.8 Variable Frequency Operation Mode

At each of the switching cycles, the falling edge of V_{SENSE} will be checked. If the falling edge of V_{SENSE} is not detected, the off-time will be extended until the falling edge of V_{SENSE} is detected. The maximum allowed transformer reset time is 125 μ s. When the transformer reset time reaches 125 μ s, the iW1676 shuts off.

9.9 Internal Loop Compensation

The iW1676 incorporates an internal Digital Error Amplifier with no requirement for external loop compensation. For a typical power supply design, the loop stability is guaranteed to provide at least 45 degrees of phase margin and -20dB of gain margin.

Low Power Off-Line Digital Green-Mode PWM Controller

9.10 Voltage Protection Features

The secondary maximum output DC voltage is limited by the iW1676. When the V_{SENSE} signal exceeds the output OVP threshold at point 1 indicated in Figure 9.3 the iW1676 shuts down.

The iW1676 protects against input line undervoltage by setting a maximum T_{ON} time. Since output power is proportional to the squared $V_{\text{IN}}T_{\text{ON}}$ product then for a given output power as V_{IN} decreases the T_{ON} will increase. Thus by knowing when the maximum T_{ON} time occurs the iW1676 detects that the minimum V_{IN} is reached, and shuts down. The maximum t_{ON} limit is set to $15.6\mu\text{s}$. Also, the iW1676 monitors the voltage on the V_{CC} pin and when the voltage on this pin is below UVLO threshold the IC shuts down immediately.

When any of these faults are met the IC remains biased to discharge the V_{CC} supply. Once V_{CC} drops below UVLO threshold, the controller resets itself and then initiates a new soft-start cycle. The controller continues attempting start-up until the fault condition is removed.

9.11 PCL, OCP and SRS Protection

9.12 Peak-current limit (PCL), over-current protection (OCP) and sense-resistor short protection (SRSP) are features built-in to the iW1676. With the I_{SENSE} pin the iW1676 is able to monitor the peak primary current. This allows for cycle by cycle peak current control and limit. When the primary peak current multiplied by the I_{SENSE} resistor is greater than 1.15V over current (OCP) is detected and the IC will immediately turn off the base driver until the next cycle. The output driver will send out a switching pulse in the next cycle, and the switching pulse will continue if the OCP threshold is not reached; or, the switching pulse will turn off again if the OCP threshold is reached. If the OCP occurs for several consecutive switching cycles, the iW1676 shuts down.

If the I_{SENSE} resistor is shorted there is a potential danger of the over current condition not being detected. Thus, the IC is designed to detect this sense-resistor-short fault after startup and shut down immediately. The V_{CC} will be discharged since the IC remains biased. Once V_{CC} drops below the UVLO threshold, the controller resets itself and then initiates a new soft-start cycle. The controller continues attempting to startup, but does not fully startup until the fault condition is removed.

9.12 Dynamic Base Current Control

One important feature of the iW1676 is that it directly drives a BJT switching device with dynamic base current control to optimize performance. The BJT base current ranges from 10mA to 31mA , and is dynamically controlled according to the power supply load change. The higher the output power, the higher the base current. Specifically, the base current is related to V_{IPK} , as shown in Figure 9.5.

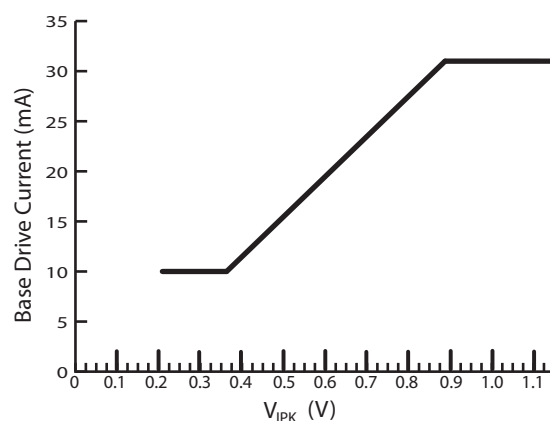

Figure 9.5 : Base Drive Current vs. V_{IPK}

Low Power Off-Line Digital Green-Mode PWM Controller

9.13 Cable Drop Compensation

The iW1676 incorporates an innovative method to compensate for any IR drop in the secondary circuit including cable and cable connector. A 2.5-W adapter with 5V DC output has 3% deviation at 0.5A load current due to the drop across a 24 AWG, 1.8m DC cable without cable compensation. The iW1676 compensates for this voltage drop by providing a voltage offset to the feedback signal based on the amount of load current detected.

The “Cable Comp” specified in the Table in Section 11 refers to the voltage increment at PCB end from no-load to full-load conditions in the CV mode, with the assumption that the secondary diode voltage drop can be ignored at the point when the secondary voltage is sensed. Also, the “Cable Comp” is specified based on the nominal output voltage of 5V. For different output voltage, the actual voltage increment needs to be scaled accordingly.

To calculate the amount of cable compensation needed, take the resistance of the cable and connector and multiply by the maximum output current.

Low Power Off-Line Digital Green-Mode PWM Controller

10 Physical Dimensions

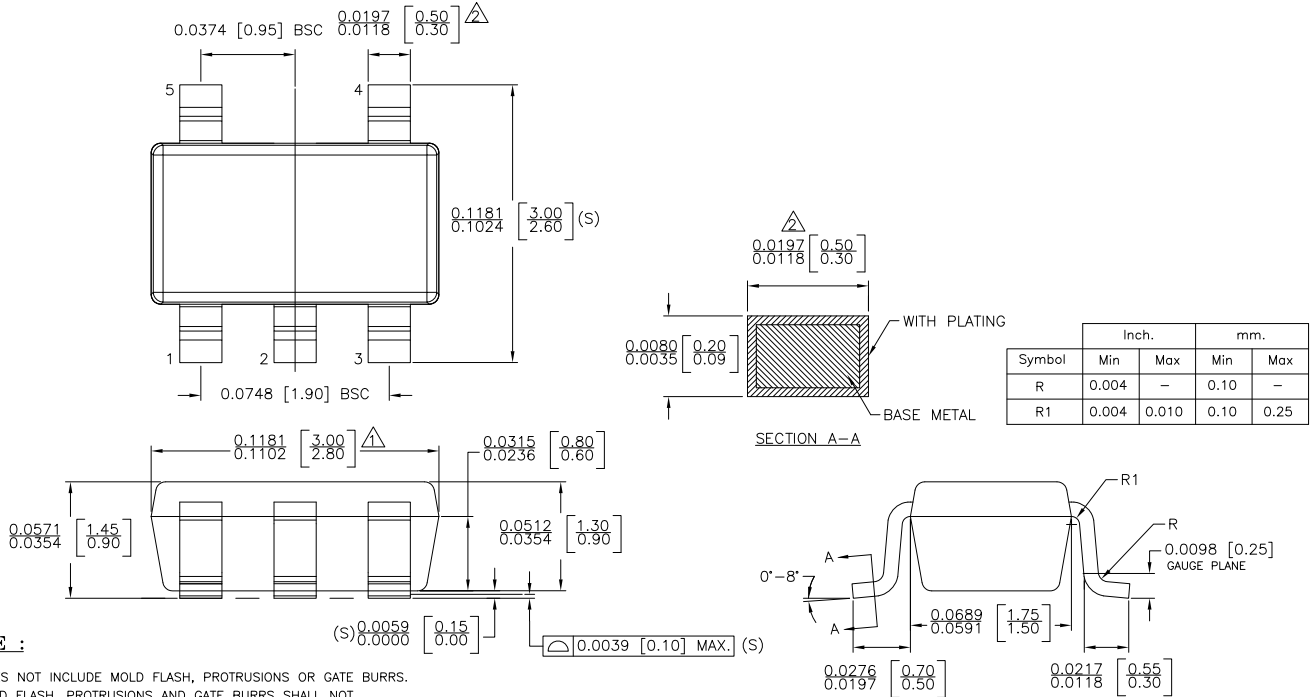

NOTE :

1. DOES NOT INCLUDE MOLD FLASH, PROTRUSIONS OR GATE BURRS. MOLD FLASH, PROTRUSIONS AND GATE BURRS SHALL NOT EXCEED 0.127 MM PER SIDE.
2. DOES NOT INCLUDE INTER-LEAD FLASH OR PROTRUSIONS. INTER-LEAD FLASH AND PROTRUSIONS SHALL NOT EXCEED 0.127 MM PER SIDE.
3. DIE IS FACING UP FOR MOLD. DIE IS FACING DOWN FOR TRIM/FORM.
4. THIS PART IS COMPLIANT WITH EIAJ SPECIFICATION SC74A AND JEDEC SPECIFICATION MO-178AA.
5. LEAD SPAN/STAND OFF HEIGHT/COPLANARITY ARE CONSIDERED AS SPECIAL CHARACTERISTIC (S)
6. CONTROLLING DIMENSIONS IN INCHES. [mm]

		STATUS:	
		RELEASED	SCALE: DO NOT SCALE
TERMINAL FINISH: 100% Sn or NiPdAu (PPF)			
TITLE: 5 SOT23 PACKAGE OUTLINE			
REV: A	REVISION NOTE: NEW DRAWING	DATE: 21-APR-2015	

11 Ordering Information

Part Number	Options	Package	Description
iW1676-01	Cable Comp = 300mV	SOT-23	Tape & Reel ¹

Note 1: Tape & Reel packing quantity is 3,000/reel. Minimum packing quantity is 3,000.

Low Power Off-Line Digital Green-Mode PWM Controller

IMPORTANT NOTICE AND DISCLAIMER

RENEASAS ELECTRONICS CORPORATION AND ITS SUBSIDIARIES ("RENEASAS") PROVIDES TECHNICAL SPECIFICATIONS AND RELIABILITY DATA (INCLUDING DATASHEETS), DESIGN RESOURCES (INCLUDING REFERENCE DESIGNS), APPLICATION OR OTHER DESIGN ADVICE, WEB TOOLS, SAFETY INFORMATION, AND OTHER RESOURCES "AS IS" AND WITH ALL FAULTS, AND DISCLAIMS ALL WARRANTIES, EXPRESS OR IMPLIED, INCLUDING, WITHOUT LIMITATION, ANY IMPLIED WARRANTIES OF MERCHANTABILITY, FITNESS FOR A PARTICULAR PURPOSE, OR NON-INFRINGEMENT OF THIRD PARTY INTELLECTUAL PROPERTY RIGHTS.

These resources are intended for developers skilled in the art designing with Renesas products. You are solely responsible for (1) selecting the appropriate products for your application, (2) designing, validating, and testing your application, and (3) ensuring your application meets applicable standards, and any other safety, security, or other requirements. These resources are subject to change without notice. Renesas grants you permission to use these resources only for development of an application that uses Renesas products. Other reproduction or use of these resources is strictly prohibited. No license is granted to any other Renesas intellectual property or to any third party intellectual property. Renesas disclaims responsibility for, and you will fully indemnify Renesas and its representatives against, any claims, damages, costs, losses, or liabilities arising out of your use of these resources. Renesas' products are provided only subject to Renesas' Terms and Conditions of Sale or other applicable terms agreed to in writing. No use of any Renesas resources expands or otherwise alters any applicable warranties or warranty disclaimers for these products.

© 2022 Renesas Electronics Corporation. All rights reserved.

RoHS Compliance

Dialog Semiconductor's suppliers certify that its products are in compliance with the requirements of Directive 2011/65/EU of the European Parliament on the restriction of the use of certain hazardous substances in electrical and electronic equipment. RoHS certificates from our suppliers are available on request.

(Rev.1.0 Mar 2020)

Corporate Headquarters

TOYOSU FORESIA, 3-2-24 Toyosu
Koto-ku, Tokyo 135-0061, Japan
www.renesas.com

Contact Information

For further information on a product, technology, the most up-to-date version of a document, or your nearest sales office, please visit:
www.renesas.com/contact/

Trademarks

Renesas and the Renesas logo are trademarks of Renesas Electronics Corporation. All trademarks and registered trademarks are the property of their respective owners.