

Off-Line Digital Green-Mode PWM Controller Integrated with Power BJT

1 Description

The iW1810 is a high performance AC/DC power supply control device which uses digital control technology to build peak current mode PWM flyback power supplies. This device includes an internal power BJT and operates in quasi-resonant mode to provide high efficiency along with a number of key built-in protection features while minimizing the external component count, simplifying EMI design and lowering the total bill of material cost. The iW1810 removes the need for secondary feedback circuitry while achieving excellent line and load regulation. It also eliminates the need for loop compensation components while maintaining stability over all operating conditions. Pulse-by-pulse waveform analysis allows for a loop response that is much faster than traditional solutions, resulting in improved dynamic load response. The built-in power limit function enables optimized transformer design in universal off-line applications and allows for a wide input voltage range.

Dialog's innovative proprietary technology ensures that power supplies built with iW1810 can achieve both highest average efficiency and less than 100mW no-load power consumption in a compact form factor.

2 Features

- Primary-side feedback eliminates optoisolators and simplifies design
- Internal 800V bipolar junction transistor (BJT)
- 64kHz PWM switching frequency
- No-load power consumption < 100mW at 230V_{AC} with typical application circuit
- Adaptive multi-mode PWM/PFM control improves efficiency
- Quasi-resonant operation for highest overall efficiency
- **EZ-EMI**[®] design to easily meet global EMI standards
- Dynamic BJT base drive current control
- Very tight constant voltage and constant current regulation with primary-side-only feedback
- No external compensation components required
- Complies with EPA 2.0 energy-efficiency specifications with ample margin
- Low start-up current (8μA typical)
- Built-in soft start
- Built-in short circuit protection and output overvoltage protection
- Built-in current sense resistor short circuit protection
- No audible noise over entire operating range

3 Applications

- Low-power AC/DC power supply for smart meters, motor control and industrial applications
- Linear AC/DC replacement
- Low-power AC/DC LED driver

Off-Line Digital Green-Mode PWM Controller
Integrated with Power BJT

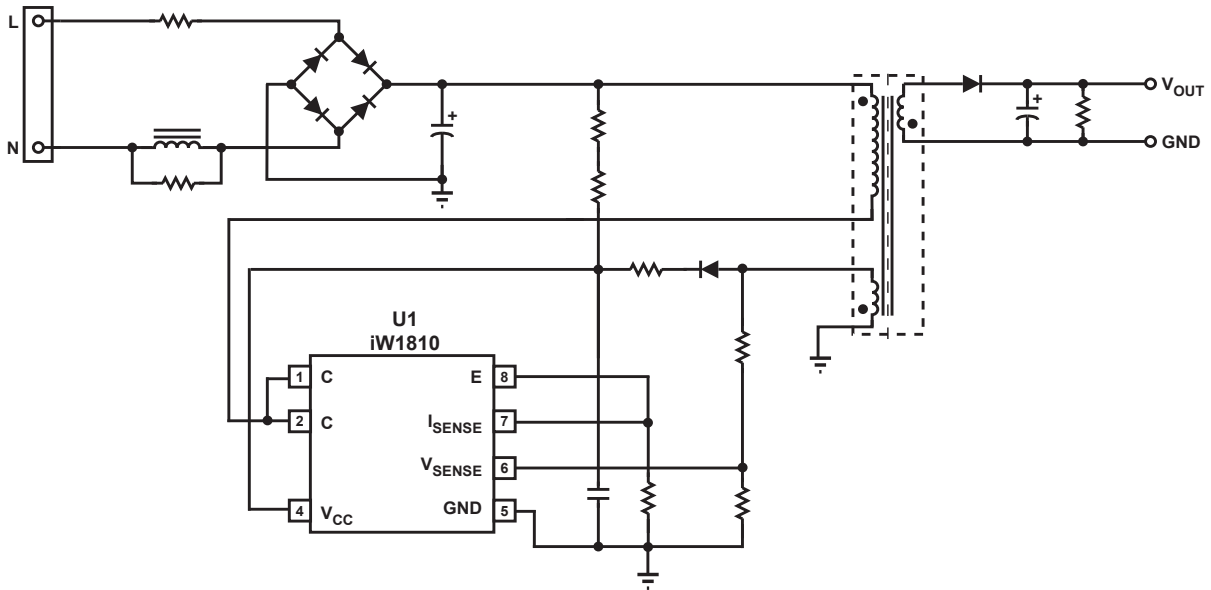

Figure 3.1 : iW1810 Typical Application Circuit

WARNING:

The iW1810 is intended for high voltage AC/DC offline applications. Contact with live high voltage offline circuits or improper use of components may cause lethal or life threatening injuries or property damage. Only qualified professionals with safety training and proper precaution should operate with high voltage offline circuits.

iW1810 Output Power Table at Universal Input (85V_{AC}–264V_{AC})

Condition	Adapter ¹	Open Frame ²
Output Power (W)	4.0	5.0

Notes:

- Note 1: Maximum practical continuous output power measured at enclosure internal ambient temperature of 60°C and device emitter pin (pin 8) temperature of ≤ 90°C (adapter is placed in a non-ventilated environment)
- Note 2: Maximum practical continuous output power measured at open frame ambient temperature of 50°C and device emitter pin (pin 8) temperature of ≤ 90°C while minimum bulk capacitor voltage is kept above 90V and no special heatsinking is used (test unit is placed in a non-ventilated environment)
- Note 3: The output power can vary depending on the power supply system designs and operating conditions. See Section 10.12 for more details.

Off-Line Digital Green-Mode PWM Controller Integrated with Power BJT

4 Pinout Description

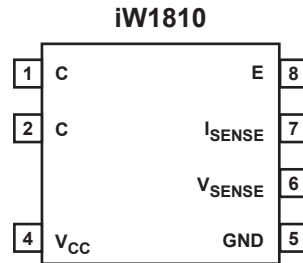

Figure 4.1 : 7-Lead SOIC Package

Pin Number	Pin Name	Type	Pin Description
1	C	BJT Collector	Collector of internal bipolar junction transistor (BJT).
2	C	BJT Collector	Collector of internal BJT.
4	V _{CC}	Power Input	Power supply for control logic.
5	GND	Ground	Ground.
6	V _{SENSE}	Analog Input	Auxiliary voltage sense (used for primary-side regulation).
7	I _{SENSE}	Analog Input	Primary current sense. Used for cycle-by-cycle peak current control and current limit.
8	E	BJT Emitter	Emitter of internal BJT. (pin 7 and pin 8 must be shorted externally on the PCB)

Off-Line Digital Green-Mode PWM Controller Integrated with Power BJT

5 Absolute Maximum Ratings

Absolute maximum ratings are the parameter values or ranges which can cause permanent damage if exceeded. For maximum safe operating conditions, refer to the Electrical Characteristics section.

Parameter	Symbol	Value	Units
DC supply voltage range (pin 4, $I_{CC} = 20\text{mA max}$)	V_{CC}	-0.3 to 18	V
Continuous DC supply current at V_{CC} pin ($V_{CC} = 15\text{V}$)	I_{CC}	20	mA
V_{SENSE} input (pin 6, $I_{V_{sense}} \leq 10\text{mA}$)		-0.7 to 4.0	V
I_{SENSE} input (pin 7)		-0.3 to 4.0	V
ESD rating per JEDEC JESD22-A114		$\pm 2,000$	V
Latch-Up test per JESD78D		± 100	mA
Collector-Emitter breakdown voltage (Emitter and base shorted together; $I_C = 1\text{mA}$, $R_{EB} = 0\Omega$)	V_{CES}	800	V
Collector current ¹	I_C	1.5	A
Collector peak current ¹ ($t_p < 1\text{ms}$)	I_{CM}	3	A
Maximum junction temperature	$T_{J\text{MAX}}$	150	°C
Storage temperature	T_{STG}	-55 to 150	°C
Lead temperature during IR reflow for ≤ 15 seconds	T_{LEAD}	260	°C

Notes:

Note 1: Limited by maximum junction temperature.

6 Absolute Maximum Ratings

Parameter	Symbol	Value	Units
Thermal Resistance Junction-to-Ambient ¹	θ_{JA}	132	°C/W
Thermal Resistance Junction-to-GND pin (pin 5) ²	Ψ_{JB}	71	°C/W
Thermal Resistance Junction-to-Collector pin (pin 1) ²	Ψ_{J-BJT}	49	°C/W

Notes:

Note 1: θ_{JA} is measured in a one-cubic-foot natural convection chamber.

Note 2: Ψ_{JB} [Psi Junction to Board] provides an estimation of the die junction temperature relative to the PCB [Board] surface temperature. Ψ_{J-BJT} [Psi Junction to Collector pin] provides an estimation of the die junction temperature relative to the collector pin [internal BJT Collector] surface temperature. Ψ_{JB} is measured at the ground pin (pin 5) without using any thermal adhesives. See Section 10.12 for more information.

Off-Line Digital Green-Mode PWM Controller Integrated with Power BJT

7 Electrical Characteristics

$V_{CC} = 12V$, $-40^{\circ}C \leq T_A \leq 85^{\circ}C$, unless otherwise specified (Note 1)

Parameter	Symbol	Test Conditions	Min	Typ	Max	Unit
V_{SENSE} SECTION (Pin 6)						
Input leakage current	I_{BVS}	$V_{SENSE} = 2V$			1	μA
Nominal voltage threshold	$V_{SENSE(NOM)}$	$T_A = 25^{\circ}C$, negative edge	1.523	1.538	1.553	V
Output OVP threshold	$V_{SENSE(MAX)}$	$T_A = 25^{\circ}C$, negative edge		1.834		V
I_{SENSE} SECTION (Pin 7)						
Overcurrent threshold	V_{OCP}			1.1	1.15	V
I _{SENSE} regulation upper limit ¹	$V_{IPK(HIGH)}$			1.0		V
I _{SENSE} regulation lower limit ¹	$V_{IPK(LOW)}$			0.25		V
Input leakage current	I_{LK}	$I_{SENSE} = 1.0V$			1	μA
V_{CC} SECTION (Pin 4)						
Maximum operating voltage ¹	$V_{CC(MAX)}$				16	V
Start-up threshold	$V_{CC(ST)}$	V_{CC} rising	9.5	10.5	11.5	V
Undervoltage lockout threshold	$V_{CC(UVL)}$	V_{CC} falling	3.9	4.1	4.3	V
Start-up Current	$I_{IN(ST)}$	$V_{CC} = 10V$		8	15	μA
Quiescent current	I_{CCQ}	No I_B current		2.5	3.5	mA
Zener breakdown voltage	V_{ZB}	Zener current = 5mA $T_A = 25^{\circ}C$	18	19	20.5	V

Off-Line Digital Green-Mode PWM Controller Integrated with Power BJT

7 Electrical Characteristics (cont.)

$V_{CC} = 12V$, $-40^{\circ}C \leq T_A \leq 85^{\circ}C$, unless otherwise specified (Note 1)

Parameter	Symbol	Test Conditions	Min	Typ	Max	Unit
BJT Section (Pin 1, Pin 2, and Pin 8)						
Collector cutoff current	I_{CB0}	$V_{CB} = 800V, I_E = 0A$			0.01	mA
Collector-Emitter cutoff current	I_{CES}	$V_{CE} = 800V, R_{EB} = 0\Omega, T_A = 25^{\circ}C$			0.01	mA
		$V_{CE} = 800V, R_{EB} = 0\Omega, T_A = 100^{\circ}C$			0.02	
		$V_{CE} = 500V, R_{EB} = 0\Omega, T_A = 25^{\circ}C$			0.005	
DC Current Gain ²	h_{FE}	$V_{CE} = 5V, I_C = 0.2A$	15		40	
		$V_{CE} = 5V, I_C = 0.3A$	10		30	
		$V_{CE} = 5V, I_C = 1mA$	10			
Collector-Base breakdown voltage	V_{CB0}	$I_C = 0.1mA$	800			V
Collector-Emitter breakdown voltage (Emitter and base shorted together)	V_{CES}	$I_C = 1mA, R_{EB} = 0\Omega$	800			V
Collector-Emitter sustain voltage	$V_{CEO(SUS)}$	$I_C = 1mA, L_M = 25mH$	500			V
Collector-Emitter saturation voltage ²	$V_{CE sat}$	$I_C = 0.1A, I_B = 0.02A$		0.1	0.3	V
PWM switching frequency	f_{SW}	> 50% load		64		kHz

Notes:

Note 1: These parameters are not 100% tested, guaranteed by design and characterization.

Note 2: Impulse $t_p \leq 300\mu s$, duty cycle $\leq 2\%$.

Note 3: Operating frequency varies based on the load conditions, see Section 10.6 for more details.

Off-Line Digital Green-Mode PWM Controller
Integrated with Power BJT

8 Typical Performance Characteristics

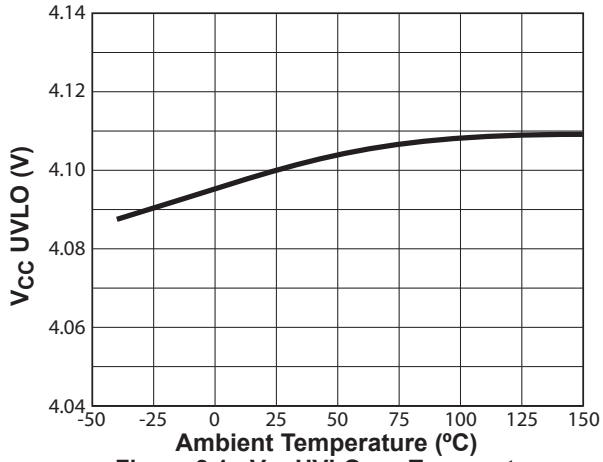

Figure 8.1 : V_{CC} UVLO vs. Temperature

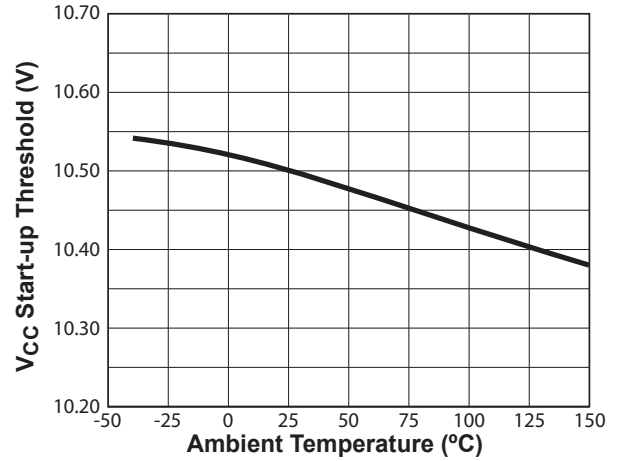

Figure 8.2 : Start-Up Threshold vs. Temperature

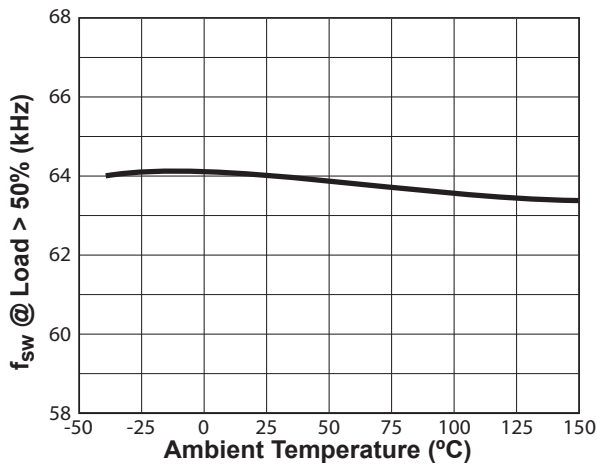

Figure 8.3 : Switching Frequency vs. Temperature¹

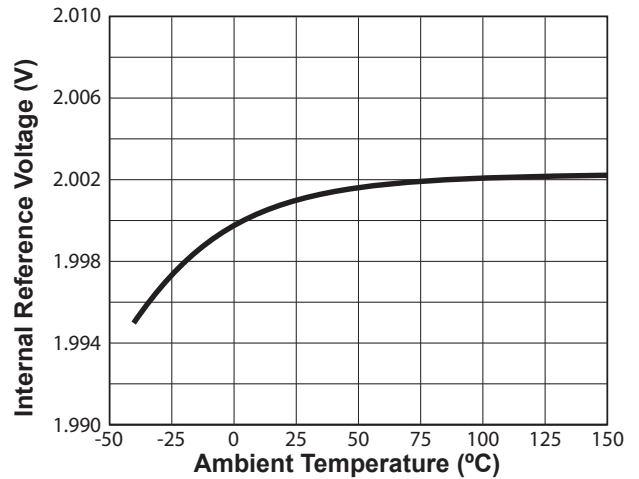

Figure 8.4 : Internal Reference vs. Temperature

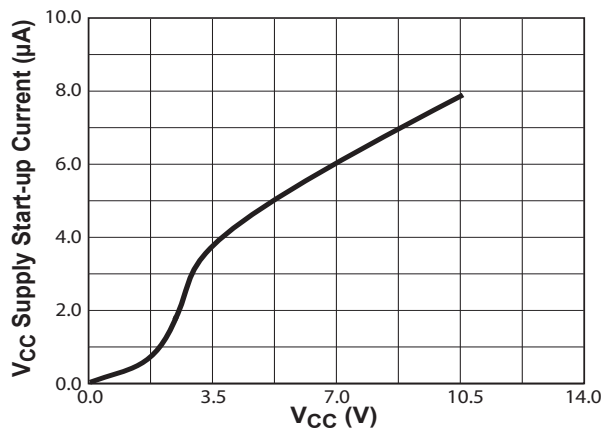

Figure 8.5 : V_{CC} vs. V_{CC} Supply Start-up Current

Note 1: Operating frequency varies based on the load conditions, see Section 10.6 for more details.

Off-Line Digital Green-Mode PWM Controller
Integrated with Power BJT

9 Functional Block Diagram

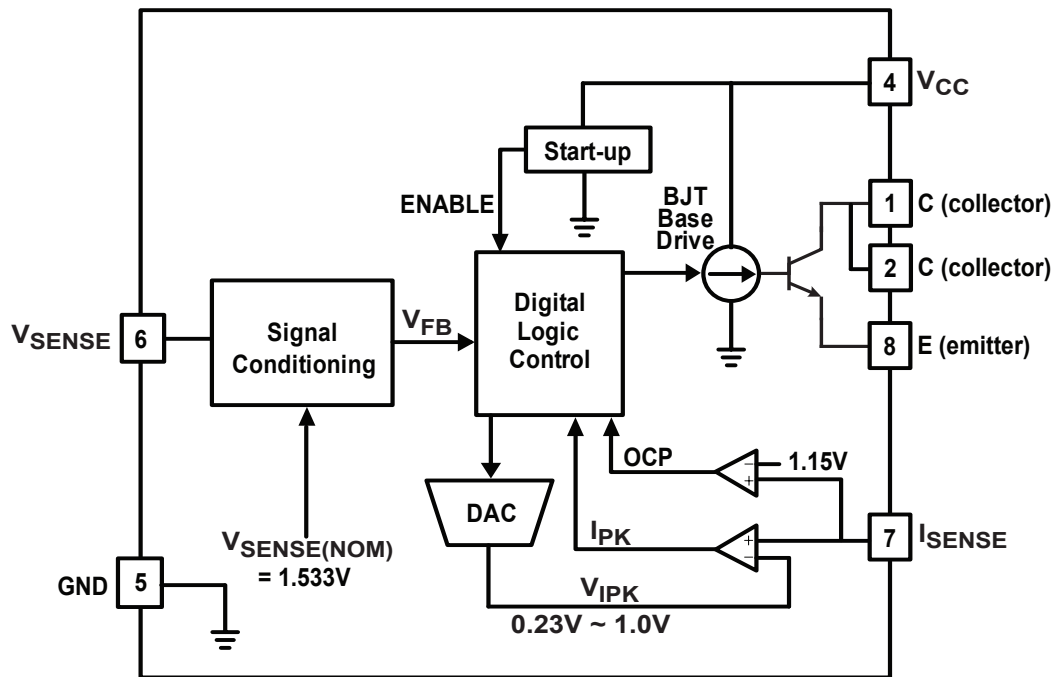

Figure 9.1 : iW1810 Functional Block Diagram

Off-Line Digital Green-Mode PWM Controller Integrated with Power BJT

10 Theory of Operation

The iW1810 is a digital controller integrated with a power BJT. It uses a proprietary primary-side control technology to eliminate the opto-isolated feedback and secondary regulation circuits required in traditional designs. This results in a low-cost solution for low power AC/DC adapters. The core PWM processor uses fixed-frequency Discontinuous Conduction Mode (DCM) operation at higher power levels and switches to variable frequency operation at light loads to maximize efficiency. Furthermore, Dialog's digital control technology enables fast dynamic response, tight output regulation, and full featured circuit protection with primary-side control.

Referring to the block diagram in Figure 9.1, the digital logic control block generates the switching on-time and off-time information based on the output voltage and current feedback signal and provides commands to dynamically control the internal BJT base current. The system loop is automatically compensated internally by a digital error amplifier. Adequate system phase margin and gain margin are guaranteed by design and no external analog components are required for loop compensation. The iW1810 uses an advanced digital control algorithm to reduce system design time and increase reliability.

Furthermore, accurate secondary constant-current operation is achieved without the need for any secondary-side sense and control circuits.

The iW1810 uses adaptive multi-mode PWM/PFM control to dynamically change the BJT switching frequency for efficiency, EMI, and power consumption optimization. In addition, it achieves unique BJT quasi-resonant switching to further improve efficiency and reduce EMI. Built-in single-point fault protection features include overvoltage protection (OVP), output short circuit protection (SCP), over current protection (OCP), and I_{SENSE} fault detection.

Dialog's digital control scheme is specifically designed to address the challenges and trade-offs of power conversion design. This innovative technology is ideal for balancing new regulatory requirements for green mode operation with more practical design considerations such as lowest possible cost, smallest size and high performance output control.

10.1 Pin Detail

Pin 1 and Pin 2 - C

The collector pin of the internal power BJT.

Pin 4 – V_{CC}

Power supply for the controller during normal operation. The controller will start up when V_{CC} reaches 10.5V (typical) and will shut-down when the V_{CC} voltage is 4.1V (typical). A decoupling capacitor should be connected between the V_{CC} pin and GND.

Pin 5 – GND

Ground.

Pin 6 – V_{SENSE}

Sense signal input from auxiliary winding. This provides the secondary voltage feedback used for output regulation.

Pin 7 – I_{SENSE}

Primary current sense. Used for cycle-by-cycle peak current control and limit.

Off-Line Digital Green-Mode PWM Controller Integrated with Power BJT

Pin 8 – E

The emitter pin of the internal power BJT. This pin must be shorted to pin 7 (the I_{SENSE} pin).

10.2 Start-up

Prior to start-up, the V_{CC} pin is charged typically through start-up resistors. When V_{CC} bypass capacitor is fully charged to a voltage higher than the start-up threshold $V_{CC(ST)}$, the ENABLE signal becomes active to enable the control logic, and the iW1810 commences soft start function. An adaptive soft-start control algorithm is applied at startup state, during which the initial output pulses will be small and gradually get larger until the full pulse width is achieved. The peak current is limited cycle by cycle by the I_{PEAK} comparator.

If at any time the V_{CC} voltage drops below $V_{CC(UVL)}$ threshold then all the digital logic is reset. At this time ENABLE signal becomes low and the V_{CC} capacitor is charged up again towards the start-up threshold.

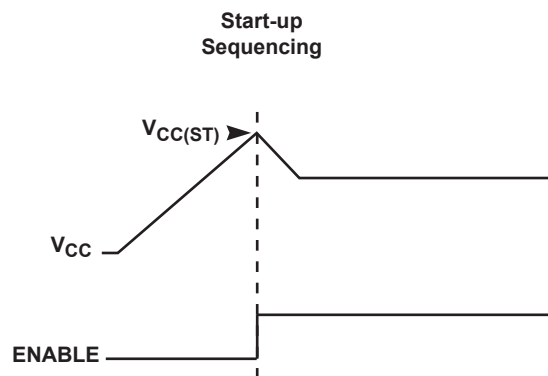

Figure 10.1 : Start-up Sequencing Diagram

10.3 Understanding Primary Feedback

Figure 10.2 illustrates a simplified flyback converter. When the switch Q1 conducts during $t_{ON}(t)$, the current $i_g(t)$ is directly drawn from rectified sinusoid $v_g(t)$. The energy $E_g(t)$ is stored in the magnetizing inductance L_M . The rectifying diode D1 is reverse biased and the load current I_O is supplied by the secondary capacitor C_O . When Q1 turns off, D1 conducts and the stored energy $E_g(t)$ is delivered to the output.

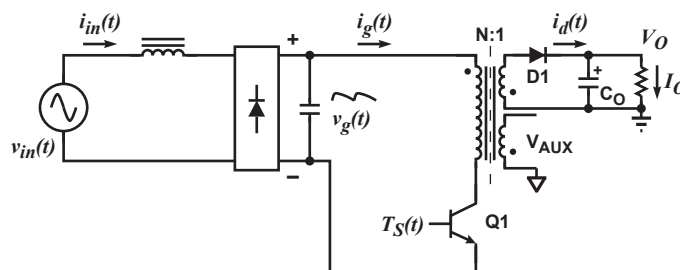

Figure 10.2 : Simplified Flyback Converter

In order to tightly regulate the output voltage, the information about the output voltage and load current need to be accurately sensed. In the DCM flyback converter, this information can be read via the auxiliary winding or the primary magnetizing inductance (L_M). During the Q1 on-time, the load current is supplied from the output filter capacitor C_O .

Off-Line Digital Green-Mode PWM Controller Integrated with Power BJT

The voltage across L_M is $v_g(t)$, assuming the voltage dropped across Q1 is zero. The current in Q1 ramps up linearly at a rate of:

$$\frac{di_g(t)}{dt} = \frac{v_g(t)}{L_M} \quad (10.1)$$

At the end of on-time, the current has ramped up to:

$$i_{g_peak}(t) = \frac{v_g(t) \times t_{ON}}{L_M} \quad (10.2)$$

This current represents a stored energy of:

$$E_g = \frac{L_M}{2} \times i_{g_peak}(t)^2 \quad (10.3)$$

When Q1, turns off at t_O , $i_g(t)$ in L_M forces a reversal of polarities on all windings. Ignoring the commutation-time caused by the leakage inductance L_K at the instant of turn-off t_O , the primary current transfers to the secondary at a peak amplitude of:

$$i_d(t) = \frac{N_P}{N_S} \times i_{g_peak}(t) \quad (10.4)$$

Assuming the secondary winding is master, and the auxiliary winding is slave,

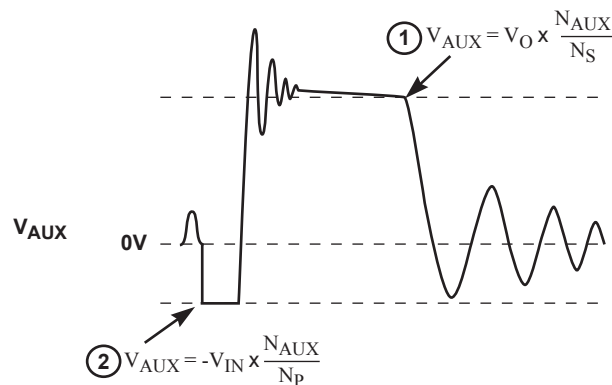

Figure 10.3 : Auxiliary Voltage Waveforms

The auxiliary voltage is given by:

$$V_{AUX} = \frac{N_{AUX}}{N_S} (V_O + \Delta V) \quad (10.5)$$

and reflects the output voltage as shown in Figure 10.3.

The voltage at the load differs from the secondary voltage by a diode drop and IR losses. Thus, if the secondary voltage is always read at a constant secondary current, the difference between the output voltage and the secondary

Off-Line Digital Green-Mode PWM Controller Integrated with Power BJT

voltage will be a fixed ΔV . Furthermore, if the voltage can be read when the secondary current is small, ΔV will also be small. With the iW1810, ΔV can be ignored.

The real-time waveform analyzer in the iW1810 reads this information cycle by cycle. The part then generates a feedback voltage V_{FB} . The V_{FB} signal precisely represents the output voltage under most conditions and is used to regulate the output voltage.

10.4 Constant Voltage Operation

After soft-start has been completed, the digital control block measures the output conditions. It determines output power levels and adjusts the control system according to a light load or heavy load. If this is in the normal range, the device operates in the Constant Voltage (CV) mode, and changes the pulse width (T_{ON}) and off time (T_{OFF}) in order to meet the output voltage regulation requirements.

If no voltage is detected on V_{SENSE} it is assumed that the auxiliary winding of the transformer is either open or shorted and the iW1810 shuts down.

10.5 Constant Current Operation

The constant current (CC mode) is useful in battery charger and LED driver applications. During this mode of operation the iW1810 will regulate the output current at a constant level regardless of the output voltage, while avoiding continuous conduction mode.

To achieve this regulation the iW1810 senses the load current indirectly through the primary current. The primary current is detected by the I_{SENSE} pin through a resistor from the BJT emitter to ground.

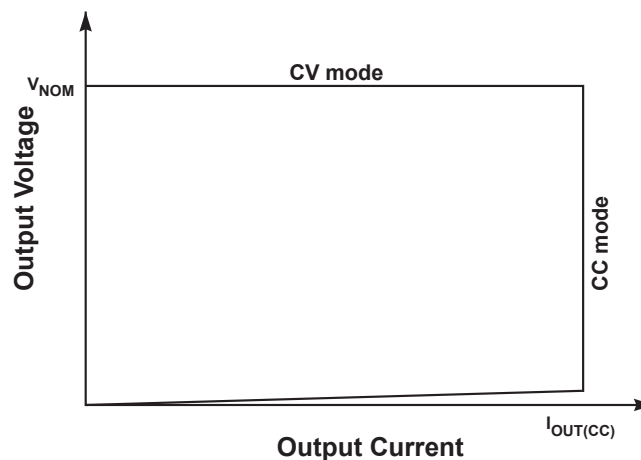

Figure 10.4 : Power Envelope

10.6 Multi-Mode PWM/PFM Control and Quasi-Resonant Switching

The iW1810 uses a proprietary adaptive multi-mode PWM/PFM control to dramatically improve the light-load efficiency and thus the overall average efficiency.

During the constant voltage (CV) operation, the iW1810 normally operates in a pulse-width-modulation (PWM) mode during heavy load conditions. In the PWM mode, the switching frequency keeps around constant. As the output load I_{OUT} is reduced, the on-time t_{ON} is decreased, and the controller adaptively transitions to a pulse-frequency-modulation (PFM) mode. During the PFM mode, the BJT is turned on for a set duration under a given instantaneous rectified AC

Off-Line Digital Green-Mode PWM Controller Integrated with Power BJT

input voltage, but its off time is modulated by the load current. With a decreasing load current, the off time increases and thus the switching frequency decreases.

As the load current is further reduced, the iW1810 transitions to a deep PFM mode (DPFM) which reduces the switching frequency to a very low level.

iW1810 also incorporates a unique proprietary quasi-resonant switching scheme that achieves valley-mode turn on for every PWM/PFM switching cycle, during all PFM and PWM modes and in both CV and CC operations. This unique feature greatly reduces the switching loss and dv/dt across the entire operating range of the power supply. Due to the nature of quasi-resonant switching, the actual switching frequency can vary slightly cycle by cycle, providing the additional benefit of reducing EMI. Together these innovative digital control architecture and algorithms enable iW1810 to achieve highest overall efficiency and lowest EMI, without causing audible noise over entire operating range.

10.7 Variable Frequency Operation Mode

At each of the switching cycles, the falling edge of V_{SENSE} will be checked. If the falling edge of V_{SENSE} is not detected, the off-time will be extended until the falling edge of V_{SENSE} is detected. The maximum allowed transformer reset time is $75\mu s$. When the transformer reset time reaches $75\mu s$, the iW1810 shuts off.

10.8 Internal Loop Compensation

The iW1810 incorporates an internal Digital Error Amplifier with no requirement for external loop compensation. For a typical power supply design, the loop stability is guaranteed to provide at least 45 degrees of phase margin and -20dB of gain margin.

10.9 Voltage Protection Features

The secondary maximum output DC voltage is limited by the iW1810. When the V_{SENSE} signal exceeds the output OVP threshold at point 1 indicated in Figure 10.3 the iW1810 shuts down.

The iW1810 protects against input line undervoltage by setting a maximum T_{ON} time. Since output power is proportional to the squared $V_{IN}T_{ON}$ product then for a given output power as V_{IN} decreases the T_{ON} will increase. Thus by knowing when the maximum T_{ON} time occurs the iW1810 detects that the minimum V_{IN} is reached, and shuts down. The maximum t_{ON} limit is set to $15\mu s$. Also, the iW1810 monitors the voltage on the V_{CC} pin and when the voltage on this pin is below UVLO threshold the IC shuts down immediately.

When any of these faults are met the IC remains biased to discharge the V_{CC} supply. Once V_{CC} drops below UVLO threshold, the controller resets itself and then initiates a new soft-start cycle. The controller continues attempting start-up until the fault condition is removed.

10.10 PCL, OCP and SRS Protection

Peak-current limit (PCL), over-current protection (OCP) and sense-resistor short protection (SRSP) are features built-in to the iW1810. With the I_{SENSE} pin the iW1810 is able to monitor the peak primary current. This allows for cycle by cycle peak current control and limit. When the primary peak current multiplied by the I_{SENSE} resistor is greater than 1.1V over current (OCP) is detected and the IC will immediately turn off the base driver until the next cycle. The output driver will send out a switching pulse in the next cycle, and the switching pulse will continue if the OCP threshold is not reached; or, the switching pulse will turn off again if the OCP threshold is reached. If the OCP occurs for several consecutive switching cycles, the iW1810 shuts down.

If the I_{SENSE} resistor is shorted there is a potential danger of the over current condition not being detected. Thus, the IC is designed to detect this sense-resistor-short fault after startup and shut down immediately. The V_{CC} will be discharged since the IC remains biased. Once V_{CC} drops below the UVLO threshold, the controller resets itself and then initiates a new soft-start cycle. The controller continues attempting to startup, but does not fully startup until the fault condition is removed.

Off-Line Digital Green-Mode PWM Controller Integrated with Power BJT

10.11 Dynamic Base Current Control

One important feature of the iW1810 is that it directly drives an internal BJT switching device with dynamic base current control to optimize performance. The BJT base current ranges from 10mA to 31mA, and is dynamically controlled according to the power supply load change. The higher the output power, the higher the base current. Specifically, the base current is related to V_{IPK} , as shown in Figure 10.5.

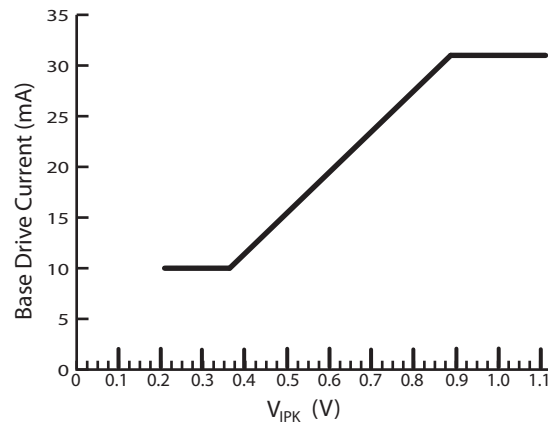
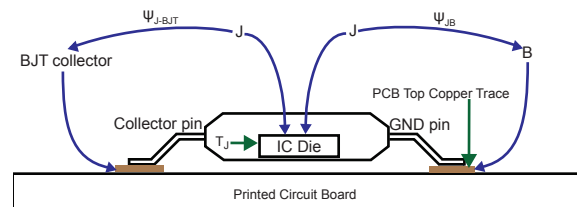

Figure 10.5 : Base Drive Current vs. V_{IPK}

10.12 Thermal Design

The iW1810 may be installed inside a small enclosure, where space and air volumes are constrained. Under these circumstances θ_{JA} (thermal resistance, junction to ambient) measurements do not provide useful information for this type of application. Hence we have also provided ψ_{JB} which estimates the increase in die junction temperature relative to the PCB surface temperature. Figure 10.6 shows the PCB surface temperature is measured at the IC's GND pin pad.



Note: For illustrative purposes only does not represent a correct pinout or size of chip

Figure 10.6 : Thermal Resistance

The actual IC power dissipation is related to the power supply application circuit, component selection, and operation conditions. The maximum IC power dissipation should be used to estimate the maximum junction temperature. For a typical 3-W power supply, the power dissipation can be around 500mW.

The output power table in Section 3.0 recommends maximum practical continuous output power level be achieved under the following conditions:

- Typical 5V-output power supply designs with a Schottky rectifier diode
- Ambient temperature of 50°C for open frame and adapter enclosure internal temperature of 60°C in a non-ventilated environment
- AC Input voltage is 85V_{AC} at 47Hz
- Minimum bulk capacitor voltage is 90V for open frame and 70V for adapter

Off-Line Digital Green-Mode PWM Controller Integrated with Power BJT

- The iW1810 device is mounted on PCB with no special enhancement for heatsinking and the emitter pin temperature is kept below 90°C

Under a given power dissipation, reducing the GND, emitter, and collector pin temperature reduces the junction temperature. Generally, increasing the PCB area and associated amount of copper trace reduces the junction temperature. In particular, the power BJT is a power source and therefore the PCB plating area attached to the two collector pins and the emitter pin can be reasonably large to gain the thermal benefits without violating the high voltage creepage requirements if higher output power is desired. Higher output power is also achievable if bulk capacitor voltage is higher, design is for high line only, design components temperature restriction limit is higher, ambient temperature is lower, or extra metal piece/heat spreader is attached to related pins or package.

Off-Line Digital Green-Mode PWM Controller
Integrated with Power BJT

11 Typical Application Schematic

7-Lead Small Outline (SOIC) Package

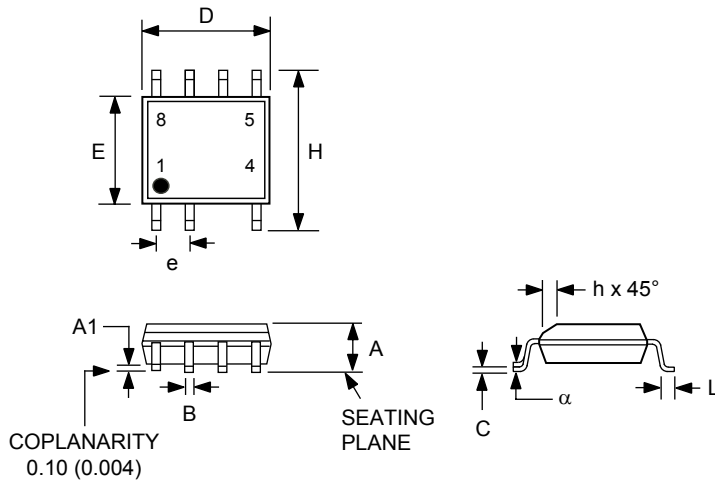

Symbol	Inches		Millimeters	
	MIN	MAX	MIN	MAX
A	0.060	0.068	1.52	1.73
A1	0.004	0.008	0.10	0.20
B	0.014	0.018	0.36	0.46
C	0.007	0.010	0.18	0.25
D	0.188	0.197	4.78	5.00
E	0.150	0.157	3.81	3.99
e	0.050 BSC		1.270 BSC	
H	0.230	0.244	5.84	6.20
h	0.010	0.016	0.25	0.41
L	0.023	0.029	0.58	0.74
α	0°	8°		

Compliant to JEDEC Standard MS12F

Controlling dimensions are in inches; millimeter dimensions are for reference only

This product is RoHS compliant and Halide free.

Soldering Temperature Resistance:

[a] Package is IPC/JEDEC Std 020D Moisture Sensitivity Level 1

[b] Package exceeds JEDEC Std No. 22-A111 for Solder Immersion Resistance; package can withstand 10 s immersion < 270°C

Dimension D does not include mold flash, protrusions or gate burrs. Mold flash, protrusions or gate burrs shall not exceed 0.15 mm per end. Dimension E1 does not include interlead flash or protrusion. Interlead flash or protrusion shall not exceed 0.25 mm per side.

The package top may be smaller than the package bottom. Dimensions D and E1 are determined at the outermost extremes of the plastic body exclusive of mold flash, tie bar burrs, gate burrs and interlead flash, but including any mismatch between the top and bottom of the plastic body.

12 Product Navigation

Part no.	Options	Package	Description
iW1810-00		SOIC-7	Tape & Reel ¹

Note 1: Tape & Reel packing quantity is 2,500/reel. Minimum packing quantity is 2,500.

Off-Line Digital Green-Mode PWM Controller Integrated with Power BJT

IMPORTANT NOTICE AND DISCLAIMER

RENESAS ELECTRONICS CORPORATION AND ITS SUBSIDIARIES ("RENESAS") PROVIDES TECHNICAL SPECIFICATIONS AND RELIABILITY DATA (INCLUDING DATASHEETS), DESIGN RESOURCES (INCLUDING REFERENCE DESIGNS), APPLICATION OR OTHER DESIGN ADVICE, WEB TOOLS, SAFETY INFORMATION, AND OTHER RESOURCES "AS IS" AND WITH ALL FAULTS, AND DISCLAIMS ALL WARRANTIES, EXPRESS OR IMPLIED, INCLUDING, WITHOUT LIMITATION, ANY IMPLIED WARRANTIES OF MERCHANTABILITY, FITNESS FOR A PARTICULAR PURPOSE, OR NON-INFRINGEMENT OF THIRD PARTY INTELLECTUAL PROPERTY RIGHTS.

These resources are intended for developers skilled in the art designing with Renesas products. You are solely responsible for (1) selecting the appropriate products for your application, (2) designing, validating, and testing your application, and (3) ensuring your application meets applicable standards, and any other safety, security, or other requirements. These resources are subject to change without notice. Renesas grants you permission to use these resources only for development of an application that uses Renesas products. Other reproduction or use of these resources is strictly prohibited. No license is granted to any other Renesas intellectual property or to any third party intellectual property. Renesas disclaims responsibility for, and you will fully indemnify Renesas and its representatives against, any claims, damages, costs, losses, or liabilities arising out of your use of these resources. Renesas' products are provided only subject to Renesas' Terms and Conditions of Sale or other applicable terms agreed to in writing. No use of any Renesas resources expands or otherwise alters any applicable warranties or warranty disclaimers for these products.

© 2022 Renesas Electronics Corporation. All rights reserved.

RoHS Compliance

Dialog Semiconductor's suppliers certify that its products are in compliance with the requirements of Directive 2011/65/EU of the European Parliament on the restriction of the use of certain hazardous substances in electrical and electronic equipment. RoHS certificates from our suppliers are available on request.

(Rev.1.0 Mar 2020)

Corporate Headquarters

TOYOSU FORESIA, 3-2-24 Toyosu
Koto-ku, Tokyo 135-0061, Japan
www.renesas.com

Contact Information

For further information on a product, technology, the most up-to-date version of a document, or your nearest sales office, please visit:
www.renesas.com/contact/

Trademarks

Renesas and the Renesas logo are trademarks of Renesas Electronics Corporation. All trademarks and registered trademarks are the property of their respective owners.