

SLG59H1341C

A Reverse Blocking 70 mΩ, 1.3 A nFET Load Switch in 1.46 mm² WLCSP

General Description

Operating from a 2.5 V to 5.5 V power supply, the SLG59H1341C is a self-powered, high-performance, 70 mΩ nFET load switch designed for high-side power-rail applications up to 1.3 A. When ON, internal reverse-current protection will quickly open the switch in the event of a reverse-voltage condition is detected (a $V_{OUT} > V_{IN} + 50\text{ mV}$ condition opens the switch). When OFF, an internal back-to-back reverse-current blocking circuit prevents reverse path leakage current.

Features

- Integrated 1.3 A Continuous I_{DS} nFET Load Switch
- Integrated Low $R_{DS(ON)}$ nFET switch: 70 mΩ
- Input Voltage: 2.5 V to 5.5 V
- Operating Temperature: -40 °C to 85 °C
- Resistor-adjustable Active Current Limit
 - ±10% accuracy for 0.2 A to 1.5 A Current Limit Thresholds
 - ±15% accuracy for 0.15 A to 0.2 A Current Limit Thresholds
- Open Drain \overline{FLT} Signaling
- Output OVP Protection
- Absolute V_{OUT} maximum voltage rating: 28 V_{DC}
- Over-temperature Protection
- Under-Voltage Lockout
- True Reverse-Current Blocking
- Low θ_{JA} , 9-pin 1.21 mm x 1.21 mm, 0.4 mm pitch 9L WLCSP Packaging
 - Pb-Free / Halogen-Free / RoHS compliant

Pin Configuration

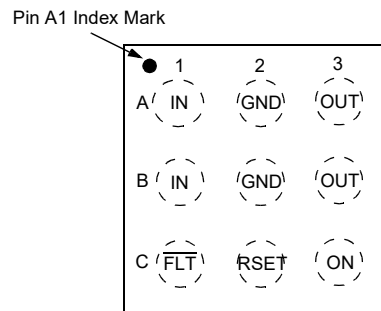

9L WLCSP
(Laser Marking View)

Applications

- Fast Turn On/Off power rail switching
- Frequent wake & sleep power cycle
- Mobile devices and portable devices

Block Diagram

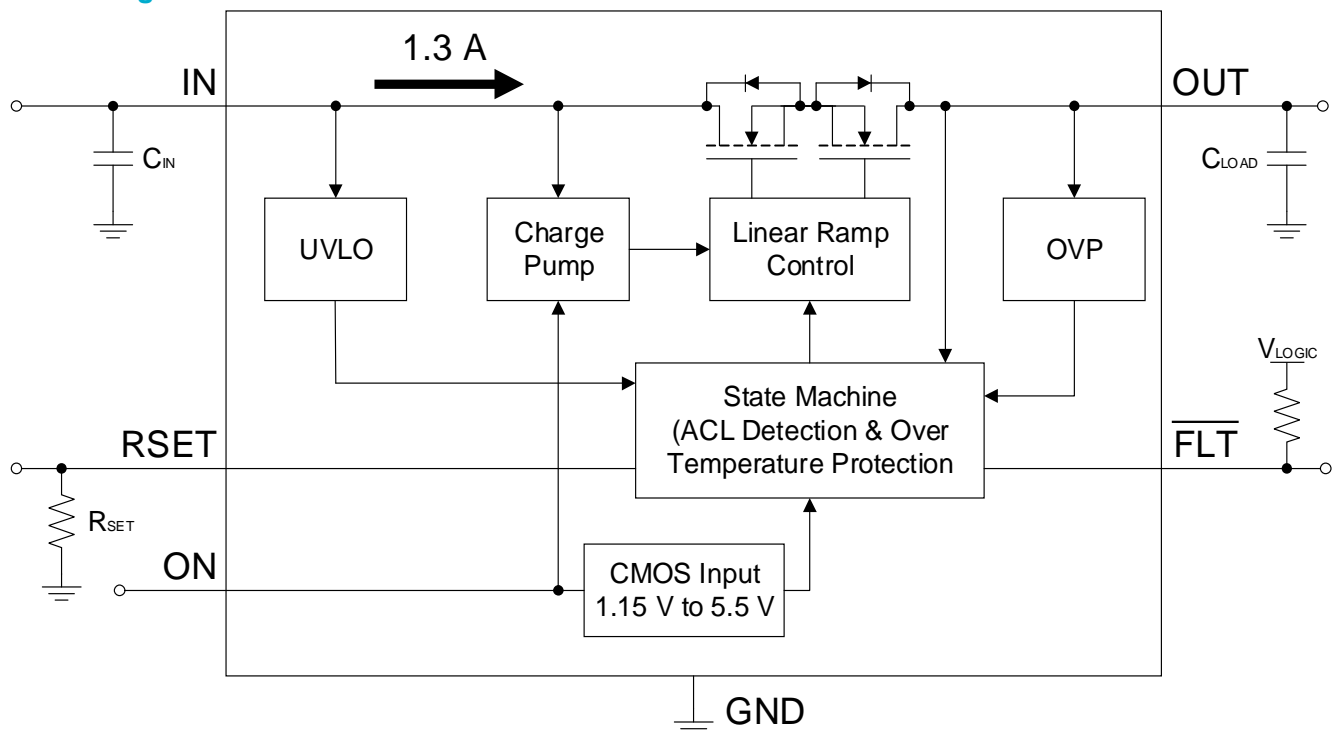

SLG59H1341C

A Reverse Blocking 70 m Ω , 1.3 A nFET
Load Switch in 1.46 mm² WLCSP

Pin Description

Pin #	Pin Name	Type	Pin Description
A1, B1	IN	MOSFET	Input terminal connection of the n-channel MOSFET. Capacitors used at IN should be rated at a voltage higher than maximum input voltage ever present.
A2, B2	GND	GND	Ground connection. Connect this pin to system analog or power ground plane.
A3, B3	OUT	MOSFET	Output terminal connection of the n-channel MOSFET. Capacitors used at OUT should be rated at a voltage higher than maximum output voltage ever present.
C1	$\overline{\text{FLT}}$	Output	An open drain output, $\overline{\text{FLT}}$ is asserted within $T_{\overline{\text{FLT}}_{\text{LOW}}}$ when a current-limit condition is detected.
C2	RSET	Input	A 1%-tolerance, metal-film resistor between 6.49 k Ω and 680 Ω sets the SLG59H1341C's active current limit. A 6.49 k Ω resistor sets the SLG59H1341C's active current limit to 0.16 A and a 680 Ω resistor sets the active current limit to 1.62 A.
C3	ON	Input	A low-to-high transition on this pin initiates the operation of the SLG59H1341C. ON is an asserted HIGH, level-sensitive CMOS input with $\text{ON}_{\text{VIL}} < 0.65 \text{ V}$ and $\text{ON}_{\text{VIH}} > 1.15 \text{ V}$. While there is an internal pull-down circuit to GND (~14 M Ω), connect this pin directly to a general-purpose output (GPO) of a microcontroller, an application processor, or a system controller.

Ordering Information

Part Number	Type	Production Flow
SLG59H1341C	WLCSP 9L	Industrial, -40 °C to 85 °C
SLG59H1341CTR	WLCSP 9L (Tape and Reel)	Industrial, -40 °C to 85 °C

SLG59H1341C

A Reverse Blocking 70 mΩ, 1.3 A nFET
Load Switch in 1.46 mm² WLCSP

Absolute Maximum Ratings

Parameter	Description	Conditions	Min.	Typ.	Max.	Unit
V _{IN}	Load Switch Input Voltage		--	--	6	V
V _{OUT} to V _{IN}	Load Switch Output Voltage to V _{IN}	Continuous	-0.3	--	28	V
V _{OUT} to GND	Load Switch Output Voltage to GND	Continuous	-0.3	--	28	V
ON, $\overline{\text{FLT}}$, RSET to GND	ON, $\overline{\text{FLT}}$, and RSET Pin Voltages to GND		-0.3	--	V _{IN}	V
T _S	Storage Temperature		-65	--	140	°C
ESD _{HBM}	ESD Protection	Human Body Model	2000	--	--	V
ESD _{CDM}	ESD Protection	Charged Device Model	2500	--	--	V
ESD _{SYS}	IEC 61000-4-2 System ESD	Air Gap (V _{IN} , V _{OUT} , V _{ON} to GND)	15	--	--	kV
		Contact (V _{IN} , V _{OUT} , V _{ON} to GND)	8	--	--	kV
MSL	Moisture Sensitivity Level		1			
θ _{JA}	Package Thermal Resistance, Junction-to-Ambient	1.21 x 1.21 mm 9L WLCSP; Determined using a 0.5 in ² , 1 oz. copper pad under each IN and OUT terminal and FR4 pcb material.	--	76	--	°C/W
MOSFET IDS _{PK}	Peak Current from IN to OUT	Maximum pulsed switch current, pulse width < 1 ms, 1% duty cycle	--	--	2	A

Note: Stresses greater than those listed under "Absolute Maximum Ratings" may cause permanent damage to the device. This is a stress rating only and functional operation of the device at these or any other conditions above those indicated in the operational sections of this specification is not implied. Exposure to absolute maximum rating conditions for extended periods may affect reliability.

Electrical Characteristics

T_A = -40 °C to 85 °C. Typical values are at V_{IN} = 5 V and T_A = 25 °C unless otherwise noted.

Parameter	Description	Conditions	Min.	Typ.	Max.	Unit
V _{IN}	Load Switch Input Voltage	-40 °C to 85 °C	2.5	--	5.5	V
V _{IN(UVLO)}	V _{IN} Undervoltage Lockout Threshold	V _{IN} ↑	--	2.4	--	V
		V _{IN} ↓	--	2.2	--	V
V _{OUT(OVP)}	V _{OUT} Overvoltage Lockout Threshold	V _{OUT} ↑	5.5	5.8	6	V
		V _{OUT} ↓	--	5.5	--	V
V _{OUT(OVP)_HYS}	V _{OUT} Overvoltage Lockout Hysteresis	V _{OUT} ↓	--	300	--	mV
t _{OVP}	OVP Response Time	V _{OUT} step from 5.5 V to 6 V; I _{DS} = 0.5 A, C _{LOAD} = 1 μF; T _A = 25 °C	1	--	4	μs
I _{IN}	Load Switch Current (Pin A1, B1)	When OFF, No load; V _{OUT} = Open	--	1	2	μA
		When ON, No load	--	65	100	μA
I _{ON_LKG}	ON Pin Input Leakage	V _{ON} = 0 V to 5 V	--	--	1	μA
RDS _{ON}	ON Resistance	V _{IN} = 3.7 V, I _{DS} = 1 A	--	75	105	mΩ
		V _{IN} = 5 V, I _{DS} = 1 A	--	70	100	mΩ
		V _{IN} = 5 V, I _{DS} = 1.5 A	--	70	--	mΩ
MOSFET IDS	Current from IN to OUT	Continuous	--	--	1.3	A

SLG59H1341C

A Reverse Blocking 70 mΩ, 1.3 A nFET
Load Switch in 1.46 mm² WLCSP

Electrical Characteristics (continued)

T_A = -40 °C to 85 °C. Typical values are at V_{IN} = 5 V and T_A = 25 °C unless otherwise noted.

Parameter	Description	Conditions	Min.	Typ.	Max.	Unit
I _{LIMIT}	Active Current Limit, I _{ACL}	V _{IN} = 5 V; R _{SET} = 6.49 kΩ; C _{IN} = 30 μF; C _{RSET} = 10 pF; C _{LOAD} = 0.1 μF; V _{OUT} = 1.68 V to 5 V	0.136	0.160	0.184	A
		V _{IN} = 5 V; R _{SET} = 2.1 kΩ; C _{IN} = 30 μF; C _{RSET} = 10 pF; C _{LOAD} = 1 μF; V _{OUT} = 1.68 V to 5 V	0.46	0.51	0.56	A
		V _{IN} = 5 V; R _{SET} = 1.07 kΩ; C _{IN} = 30 μF; C _{RSET} = 10 pF; C _{LOAD} = 4.4 μF; V _{OUT} = 1.68 V to 5 V	0.92	1.02	1.12	A
T _{ACL}	Active Current Limit Response Time	I _{DS} > I _{ACL} ; V _{OUT} ≤ V _{IN}	--	7	--	μs
T _{HACL}	Hard Active Current Limit Response Time	I _{DS} > I _{ACL} ; V _{OUT} = 0 V	--	6	--	μs
I _{FET_OFF}	MOSFET OFF Leakage Current	ON = LOW; V _{OUT} = 0 V, V _{IN} = 5.5 V	--	0.1	4	μA
V _{RVD_T}	Reverse-voltage Detect Threshold Voltage	V _{OUT} - V _{IN} ; ON = HIGH	--	50	--	mV
T _{RVD_T}	Reverse-voltage Detect Threshold Response Time	V _{IN} = 5 V; ON = HIGH	--	2	--	μs
V _{RVD_R}	Reverse-voltage Detect Release Threshold Voltage	V _{IN} - V _{OUT} ; ON = HIGH	--	0	--	mV
V _{RVD_HYS}	Reverse-voltage Detect Hysteresis		--	50	--	mV
I _{REVERSE}	MOSFET Reverse Leakage Current	V _{ON} = 0 V; V _{OUT} = 5.5 V	--	7	--	μA
T _{ON_Delay}	ON Delay Time	10% ON to 10% V _{OUT} ↑; T _A = -40 °C to 85 °C; V _{IN} = 5 V; R _{LOAD} = 3.8 Ω, C _{LOAD} = 10 μF	--	650	780	μs
		10% ON to 10% V _{OUT} ↑; V _{IN} = 5 V; R _{LOAD} = 100 Ω, C _{LOAD} = 1 μF	--	670	--	μs
T _{Total_ON}	Total Turn ON Time	10% ON to 90% V _{OUT} ↑; T _A = -40 °C to 85 °C; V _{IN} = 5 V; R _{LOAD} = 3.8 Ω, C _{LOAD} = 10 μF	--	1.3	1.6	ms
		10% ON to 90% V _{OUT} ↑; V _{IN} = 5 V; R _{LOAD} = 100 Ω, C _{LOAD} = 1 μF	--	1.36	--	ms
T _{RISE}	V _{OUT} Rise Time	10% V _{OUT} to 90% V _{OUT} ↑; T _A = -40 °C to 85 °C; V _{IN} = 5 V; R _{LOAD} = 3.8 Ω, C _{LOAD} = 10 μF	--	0.65	0.82	ms
		10% V _{OUT} to 90% V _{OUT} ↑; V _{IN} = 5 V; R _{LOAD} = 100 Ω, C _{LOAD} = 1 μF	--	0.69	--	ms

SLG59H1341C

A Reverse Blocking 70 mΩ, 1.3 A nFET
Load Switch in 1.46 mm² WLCSP

Electrical Characteristics (continued)

T_A = -40 °C to 85 °C. Typical values are at V_{IN} = 5 V and T_A = 25 °C unless otherwise noted.

Parameter	Description	Conditions	Min.	Typ.	Max.	Unit
T _{OFF_Delay}	OFF Delay Time	90% ON to 90% V _{OUT} ↓; T _A = -40 °C to 85 °C; V _{IN} = 5 V; R _{LOAD} = 3.8 Ω, C _{LOAD} = 10 μF	--	4	10	μs
		90% ON to 90% V _{OUT} ↓; V _{IN} = 5 V; R _{LOAD} = 100 Ω, C _{LOAD} = 1 μF	--	10	--	μs
T _{FALL}	V _{OUT} Fall Time	90% V _{OUT} to 10% V _{OUT} ; T _A = -40 °C to 85 °C; ON = HIGH-to-LOW; V _{IN} = 5 V; R _{LOAD} = 3.8 Ω, C _{LOAD} = 10 μF	--	76	120	μs
		90% V _{OUT} to 10% V _{OUT} ; ON = HIGH-to-LOW; V _{IN} = 5 V; R _{LOAD} = 100 Ω, C _{LOAD} = 1 μF	--	220	--	μs
C _{LOAD}	Output Load Capacitance	C _{LOAD} connected from OUT to GND	--	--	220	μF
T _{FLT_LOW}	FLT Assertion Time	Abnormal Step Load Current event to FLT ↓;	--	8	--	ms
V _{FLT_VOL}	FLT Output Low Voltage	I _{SINK} = 10 mA; V _{IN} = 5 V;	--	0.1	0.2	V
		I _{SINK} = 10 mA; V _{IN} = 2.5 V;	--	0.15	0.3	V
I _{FLT_Leakage}	FLT Output High Leakage Current	V _{IN} = 5 V; Switch is in On state	--	--	1	μA
ON_V _{IH}	High Input Voltage on ON pin		1.15	--	--	V
ON_V _{IL}	Low Input Voltage on ON pin		-0.3	0	0.65	V
THERM _{ON}	Thermal Protection Shutdown Threshold		--	150	--	°C
THERM _{OFF}	Thermal Protection Restart Threshold		--	130	--	°C

SLG59H1341C

A Reverse Blocking 70 mΩ, 1.3 A nFET
Load Switch in 1.46 mm² WLCSP

Timing Parameter Details

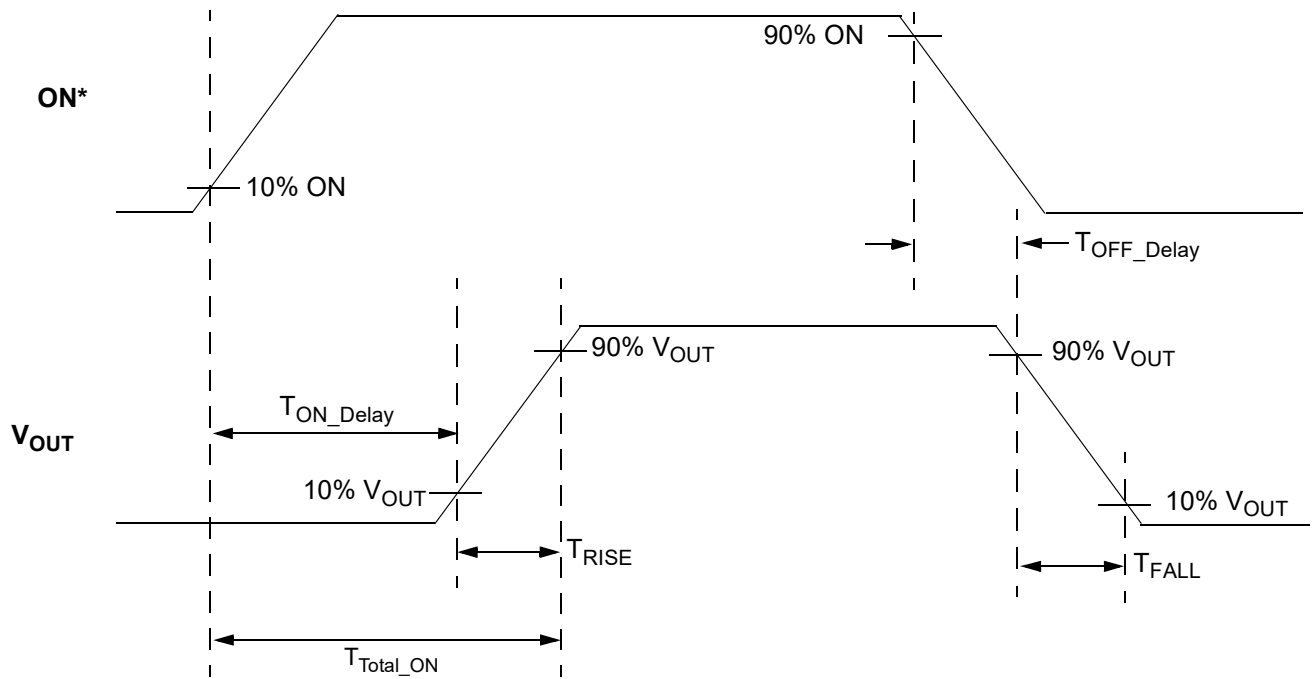

*Rise and Fall Times of the ON Signal are 100 ns

SLG59H1341C

A Reverse Blocking 70 mΩ, 1.3 A nFET
Load Switch in 1.46 mm² WLCSP

Typical Performance Characteristics

RDS_{ON} vs. I_{DS} and V_{IN}

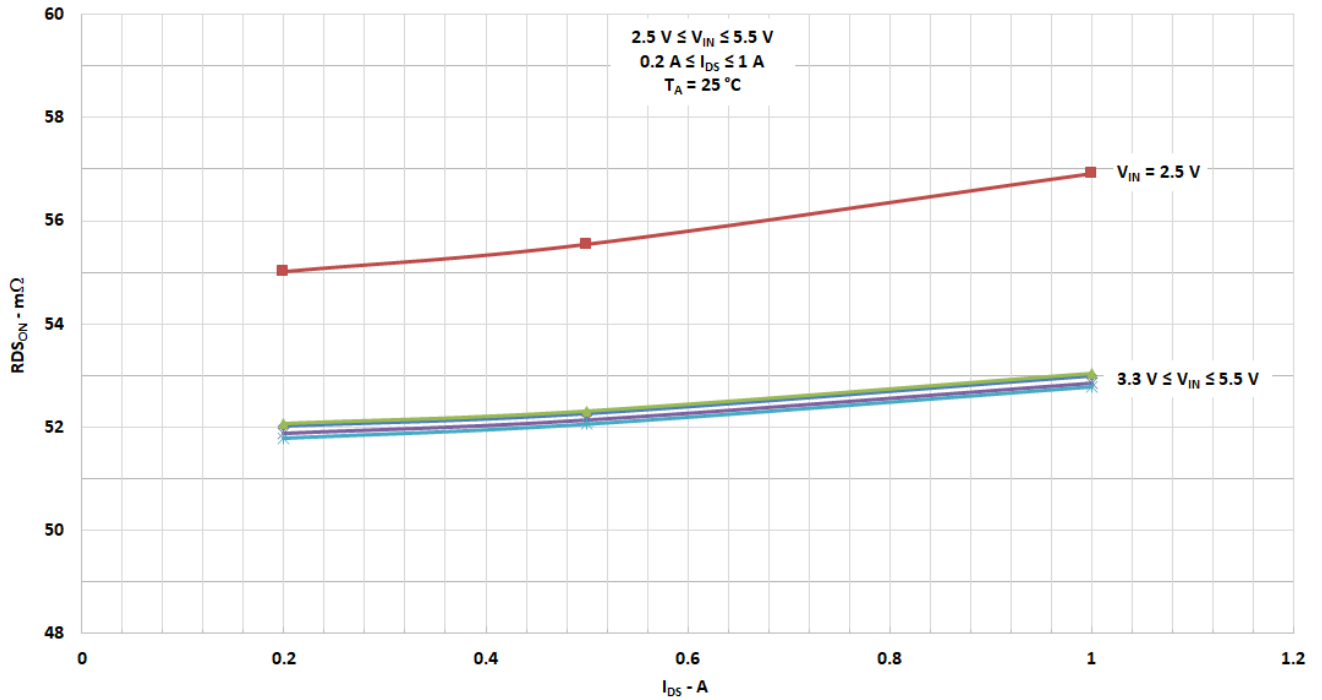

RDS_{ON} vs. Temperature and V_{IN}

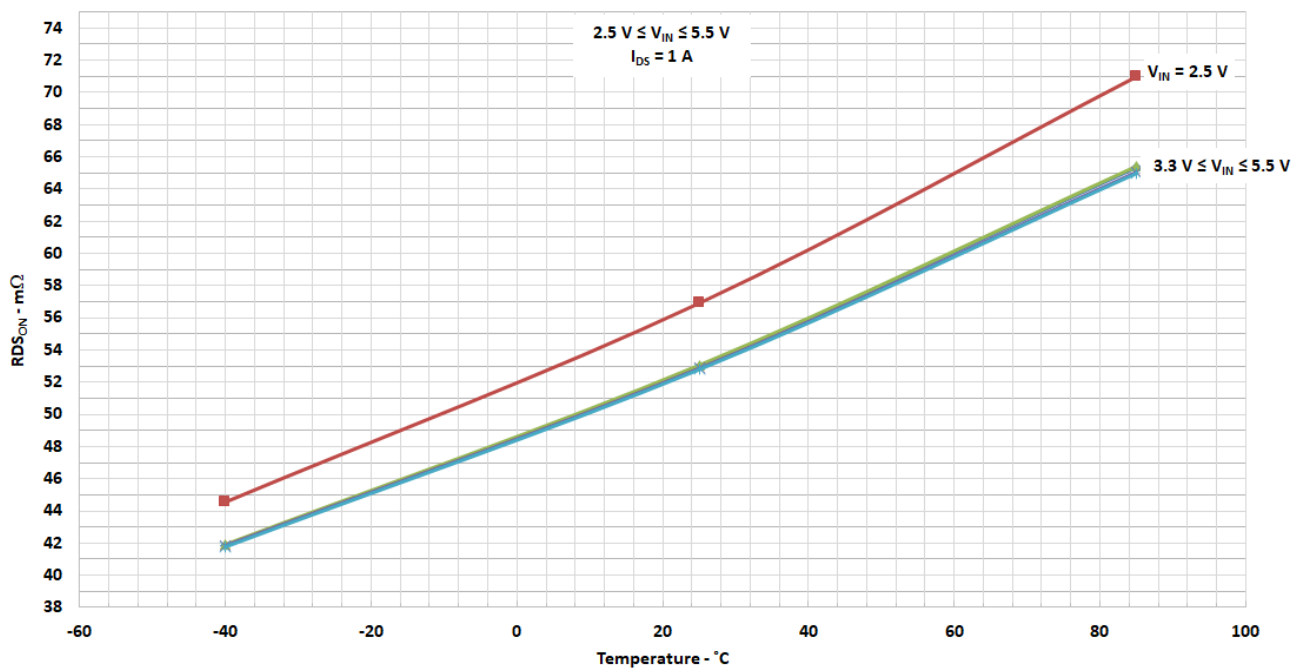

SLG59H1341C

A Reverse Blocking 70 mΩ, 1.3 A nFET Load Switch in 1.46 mm² WLCSP

I_{ACL} vs. R_{SET} and V_{IN}

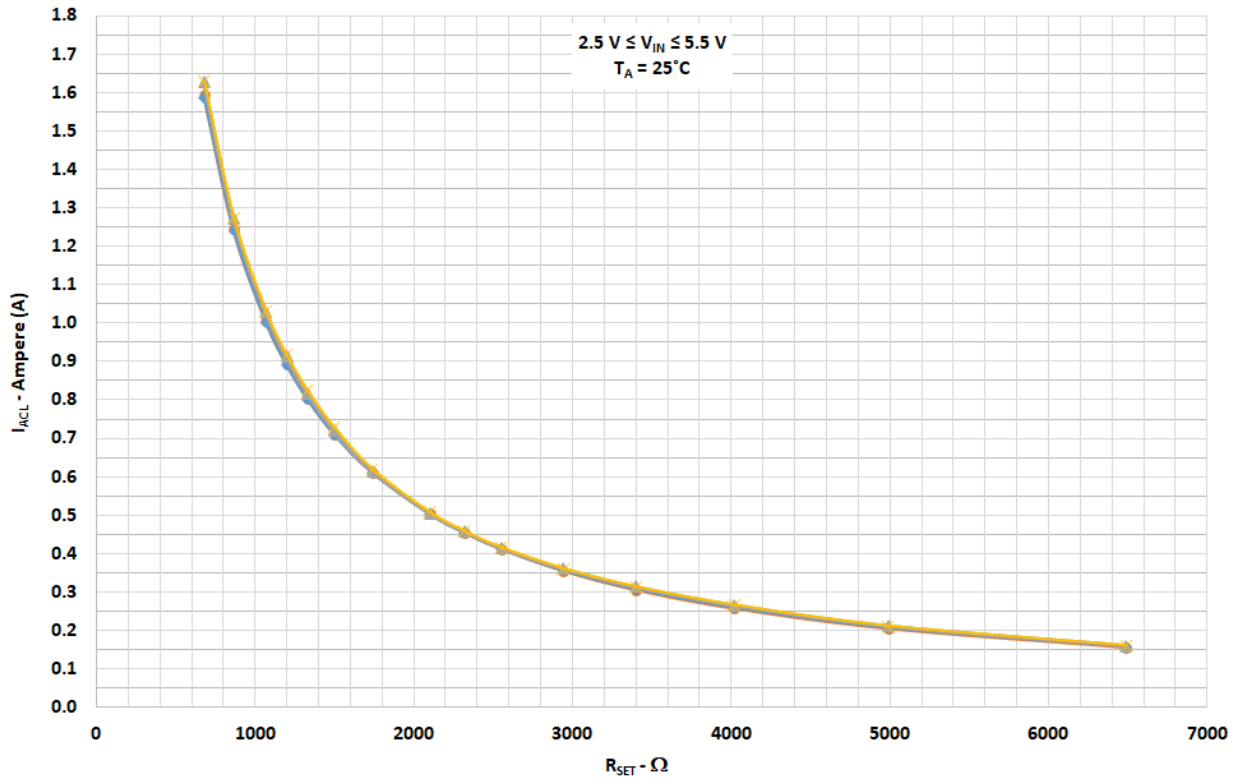

I_{ACL} vs. Temperature, V_{IN}, and R_{SET}

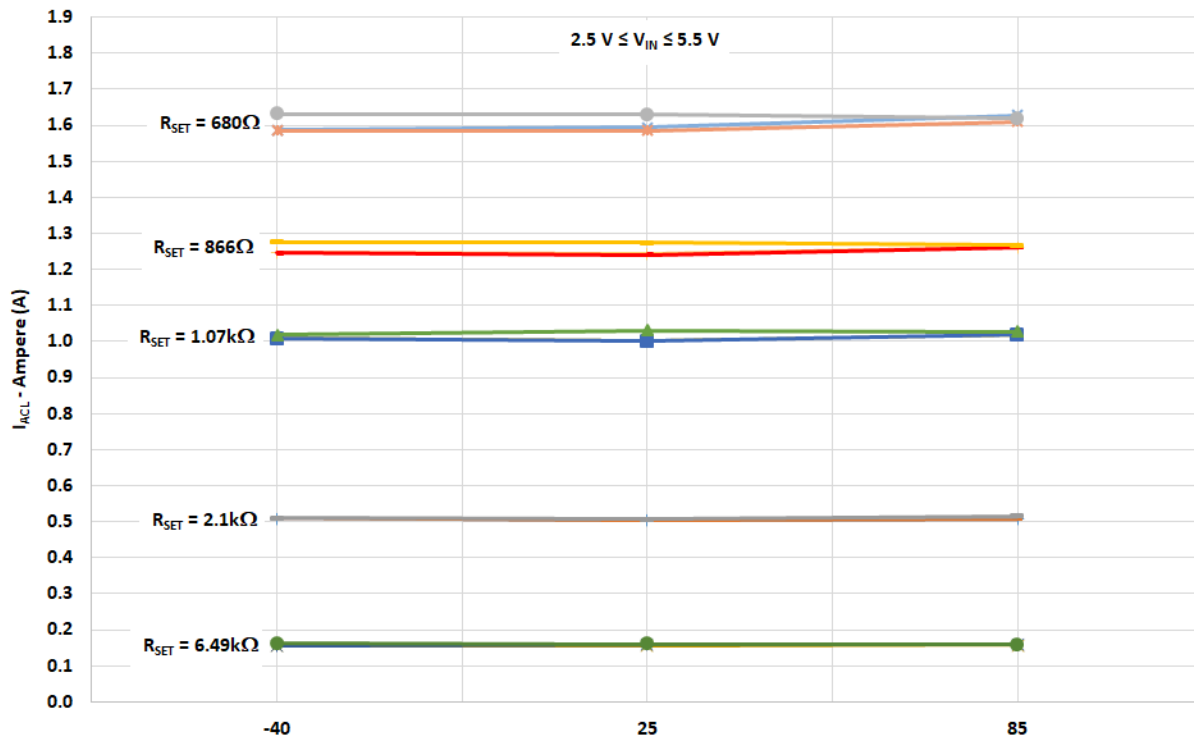

SLG59H1341C

A Reverse Blocking 70 mΩ, 1.3 A nFET
Load Switch in 1.46 mm² WLCSP

Typical Turn ON Operation Waveforms

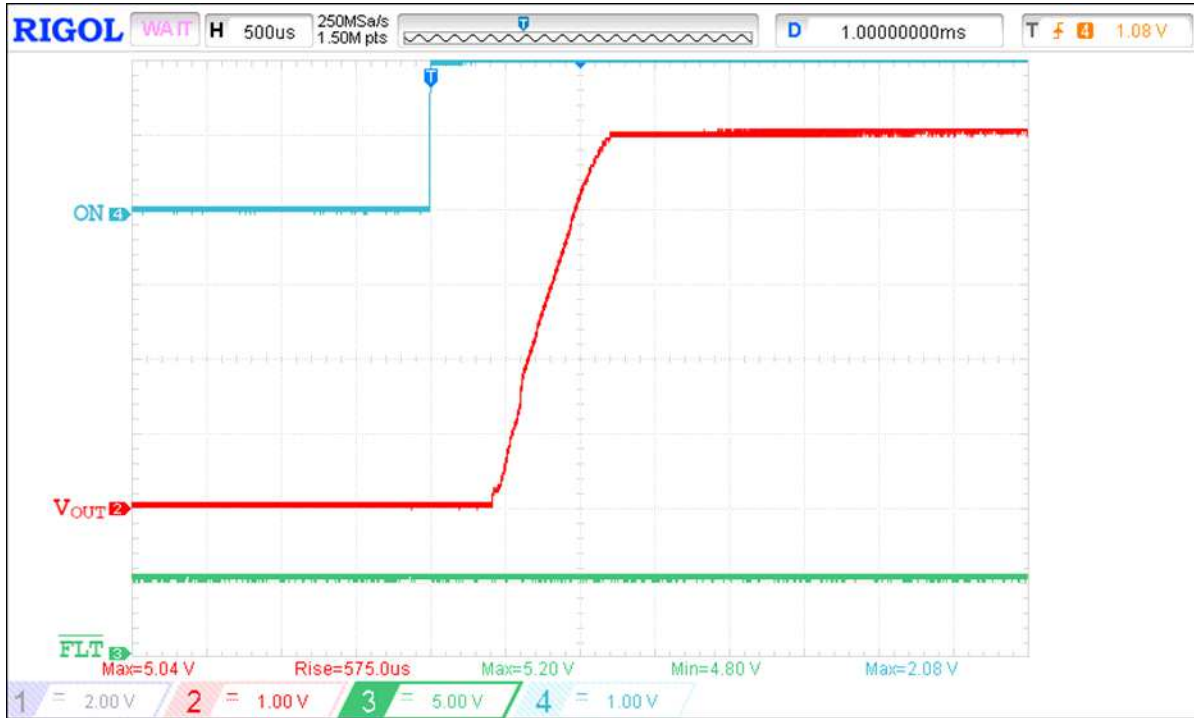

Figure 1. Typical Turn ON operation waveform for $V_{IN} = 5\text{ V}$, $R_{LOAD} = 100\ \Omega$, $C_{LOAD} = 0.1\ \mu\text{F}$

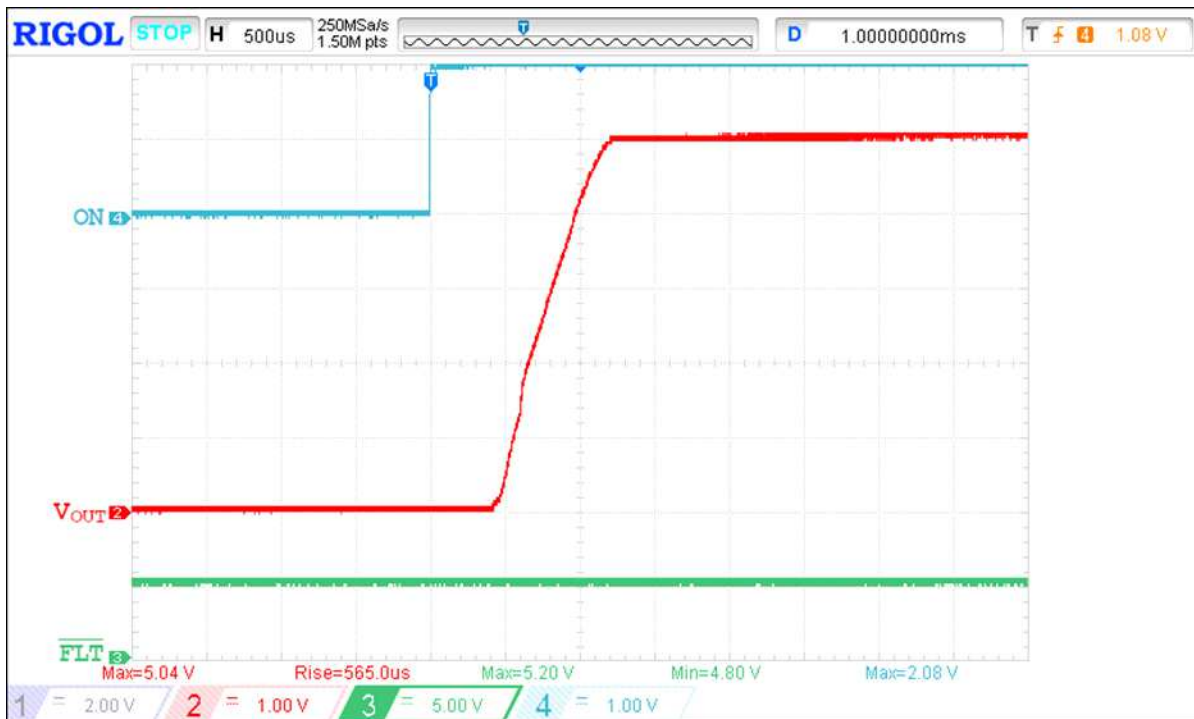

Figure 2. Typical Turn ON operation waveform for $V_{IN} = 5\text{ V}$, $R_{LOAD} = 100\ \Omega$, $C_{LOAD} = 1\ \mu\text{F}$

SLG59H1341C

A Reverse Blocking 70 mΩ, 1.3 A nFET
Load Switch in 1.46 mm² WLCSP

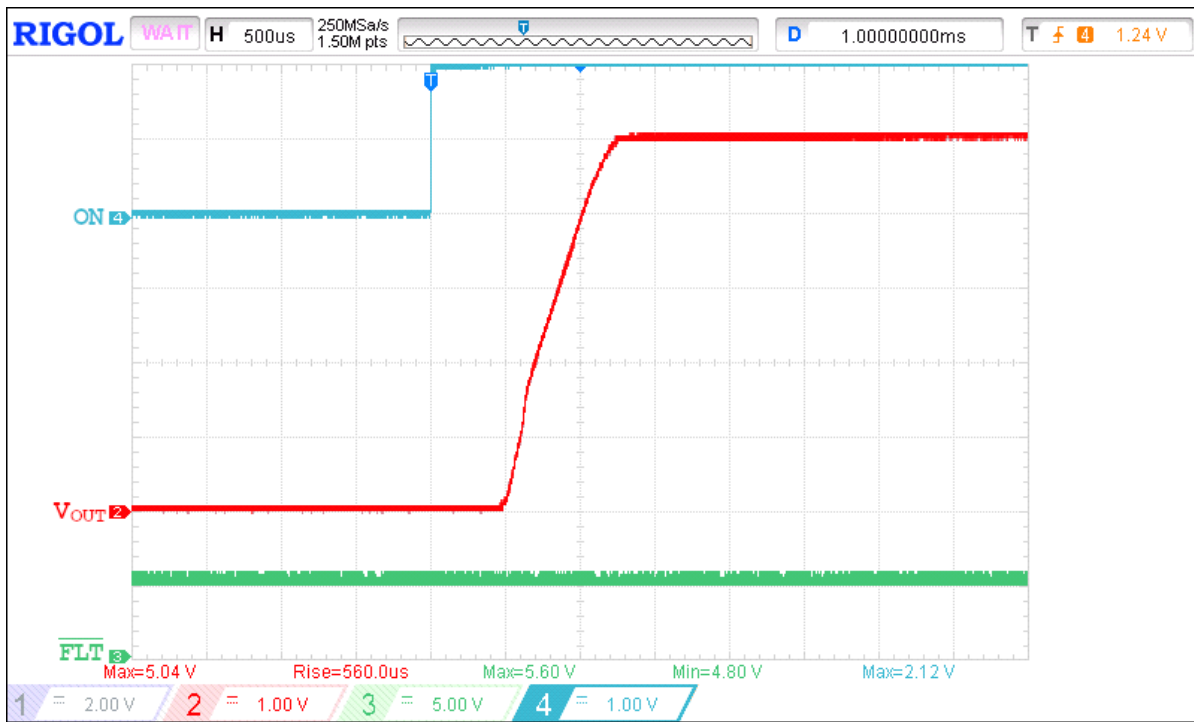

Figure 3. Typical Turn ON operation waveform for $V_{IN} = 5\text{ V}$, $R_{LOAD} = 100\ \Omega$, $C_{LOAD} = 10\ \mu\text{F}$

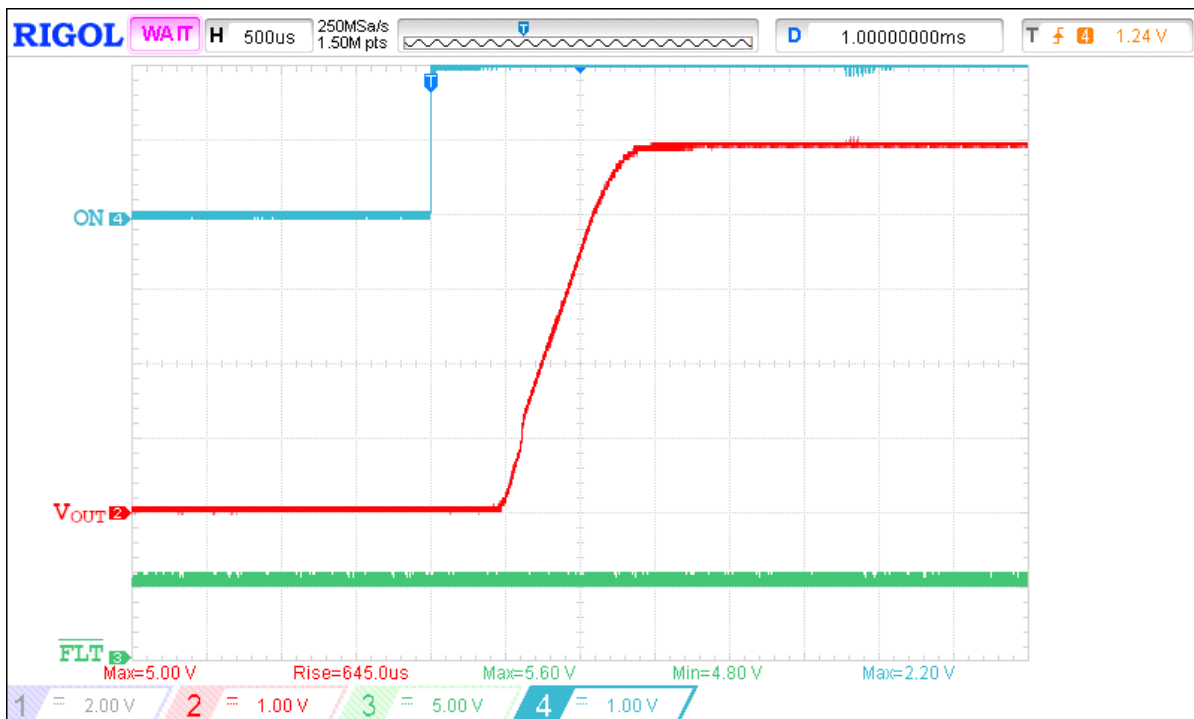

Figure 4. Typical Turn ON operation waveform for $V_{IN} = 5\text{ V}$, $R_{LOAD} = 3.8\ \Omega$, $C_{LOAD} = 0.1\ \mu\text{F}$

SLG59H1341C

A Reverse Blocking 70 mΩ, 1.3 A nFET
Load Switch in 1.46 mm² WLCSP

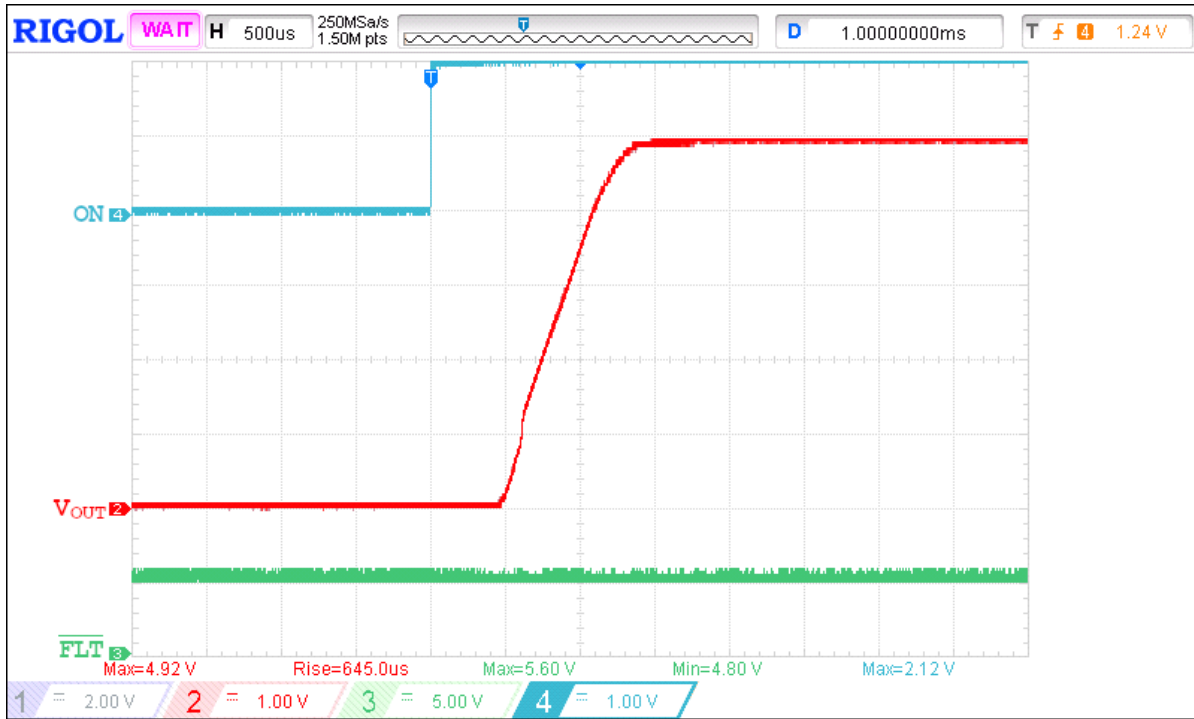

Figure 5. Typical Turn ON operation waveform for $V_{IN} = 5\text{ V}$, $R_{LOAD} = 3.8\ \Omega$, $C_{LOAD} = 1\ \mu\text{F}$

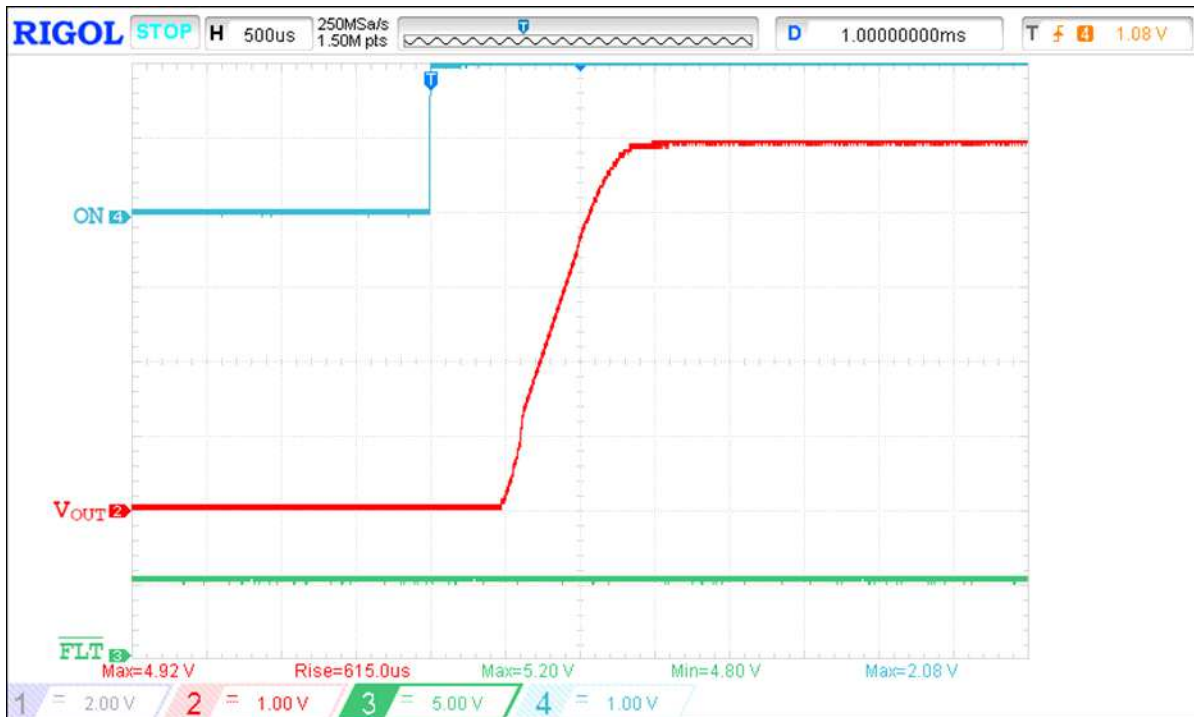

Figure 6. Typical Turn ON operation waveform for $V_{IN} = 5\text{ V}$, $R_{LOAD} = 3.8\ \Omega$, $C_{LOAD} = 10\ \mu\text{F}$

SLG59H1341C

A Reverse Blocking 70 mΩ, 1.3 A nFET
Load Switch in 1.46 mm² WLCSP

Typical Turn OFF Operation Waveforms

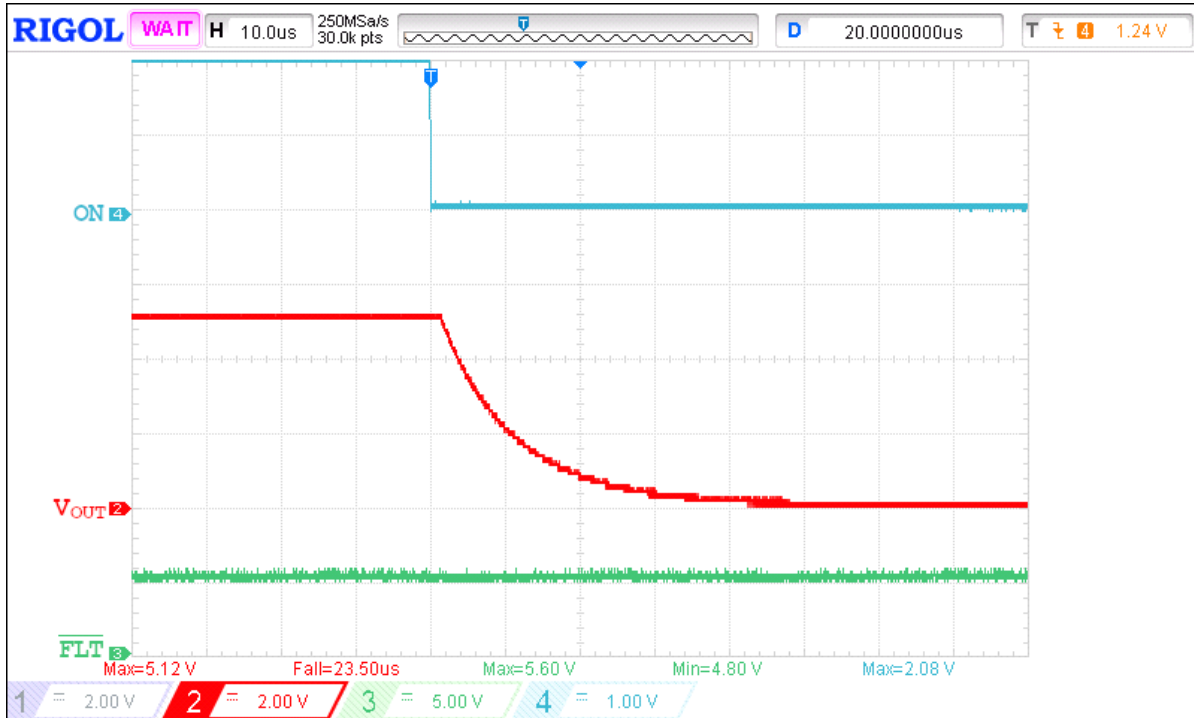

Figure 7. Typical Turn OFF operation waveform for $V_{IN} = 5\text{ V}$, $R_{LOAD} = 100\ \Omega$, $C_{LOAD} = 0.1\ \mu\text{F}$

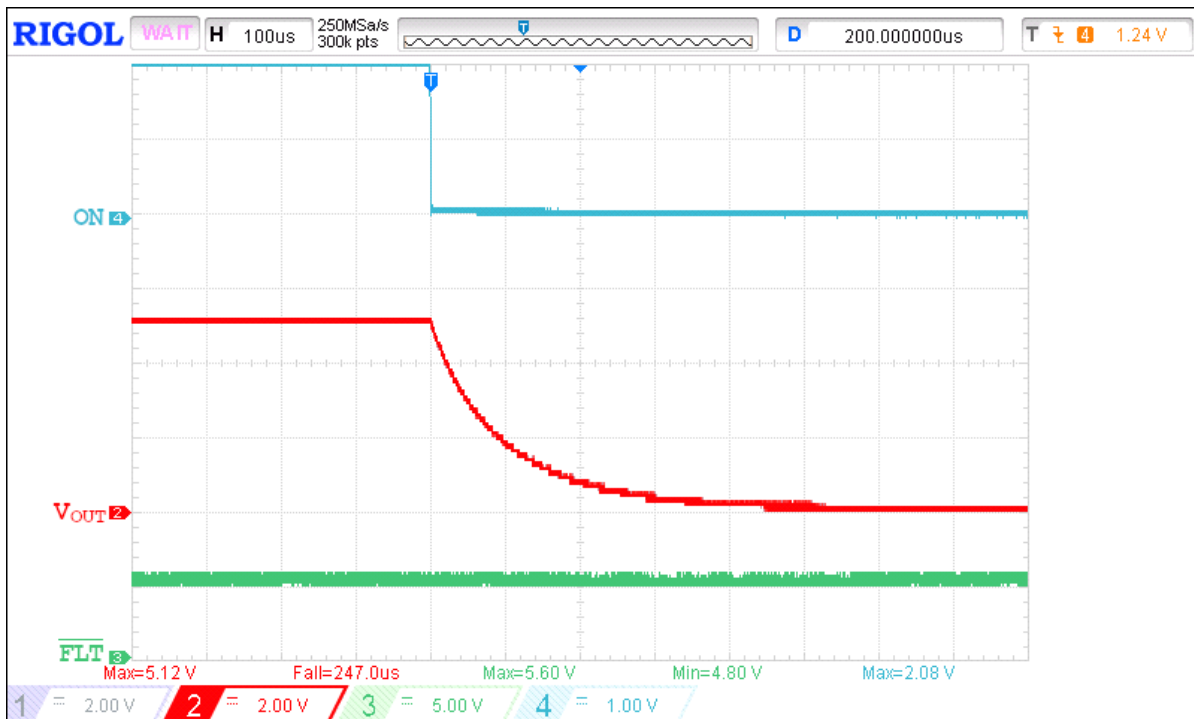

Figure 8. Typical Turn OFF operation waveform for $V_{IN} = 5\text{ V}$, $R_{LOAD} = 100\ \Omega$, $C_{LOAD} = 1\ \mu\text{F}$

SLG59H1341C

A Reverse Blocking 70 mΩ, 1.3 A nFET
Load Switch in 1.46 mm² WLCSP

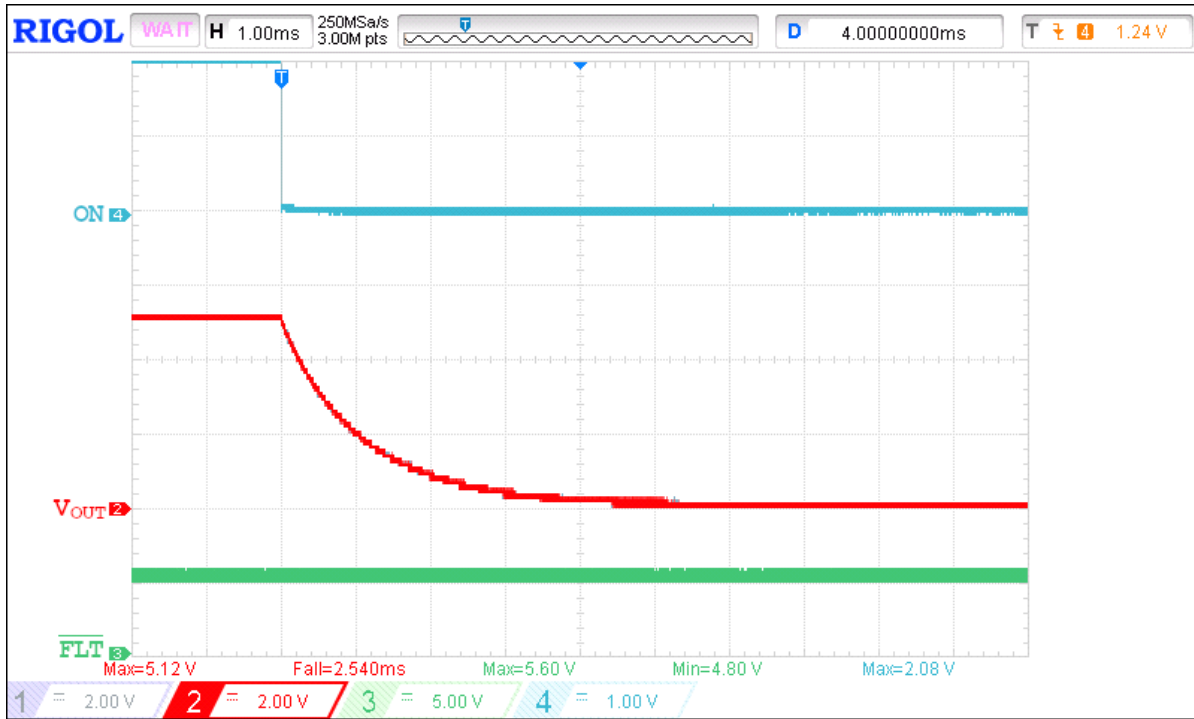

Figure 9. Typical Turn OFF operation waveform for $V_{IN} = 5\text{ V}$, $R_{LOAD} = 100\ \Omega$, $C_{LOAD} = 10\ \mu\text{F}$

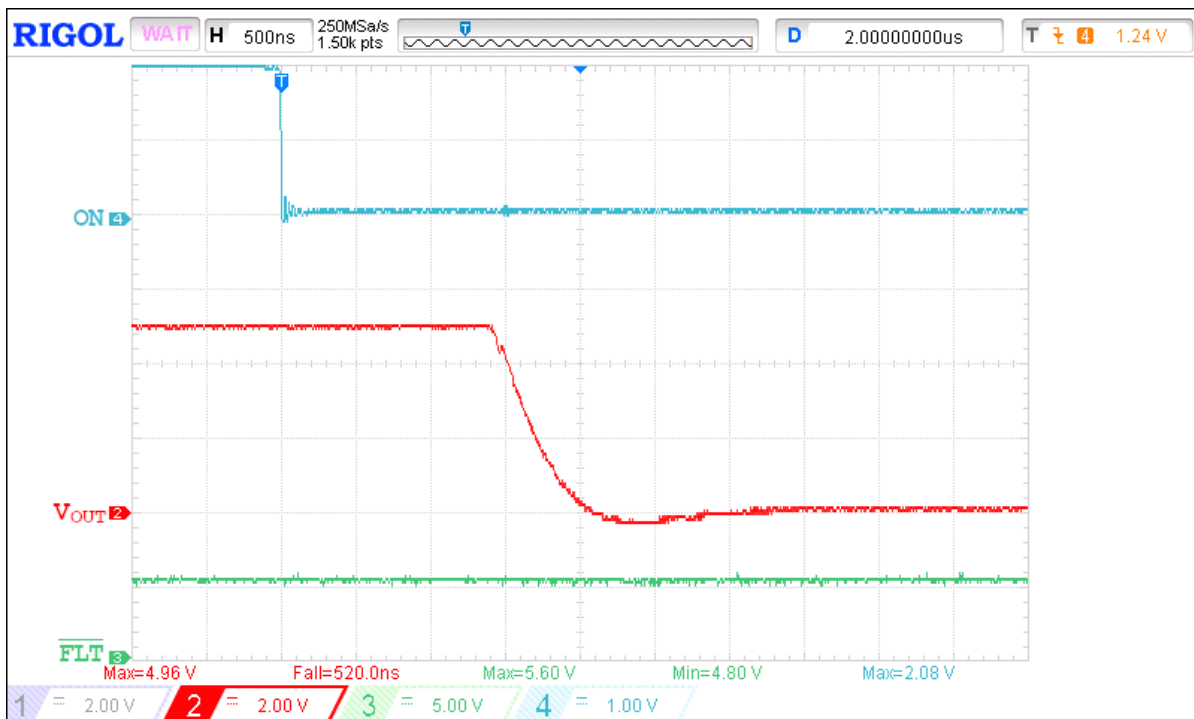

Figure 10. Typical Turn OFF operation waveform for $V_{IN} = 5\text{ V}$, $R_{LOAD} = 3.8\ \Omega$, $C_{LOAD} = 0.1\ \mu\text{F}$

SLG59H1341C

A Reverse Blocking 70 mΩ, 1.3 A nFET
Load Switch in 1.46 mm² WLCSP

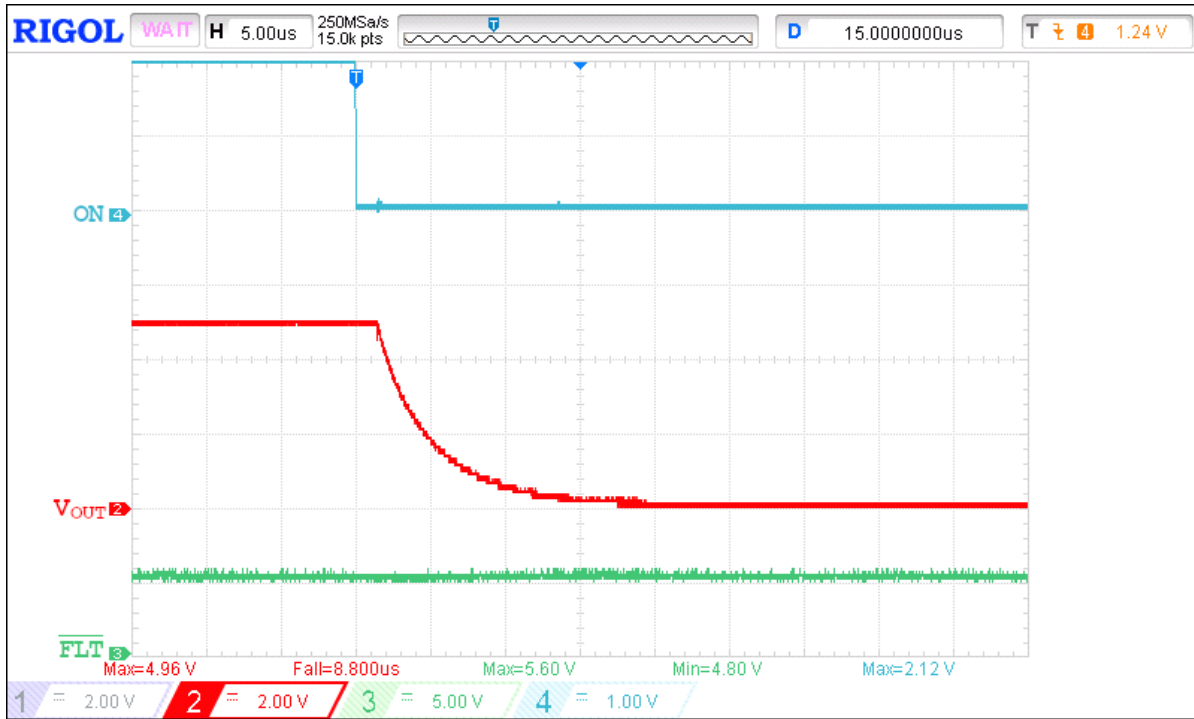

Figure 11. Typical Turn OFF operation waveform for $V_{IN} = 5\text{ V}$, $R_{LOAD} = 3.8\ \Omega$, $C_{LOAD} = 1\ \mu\text{F}$

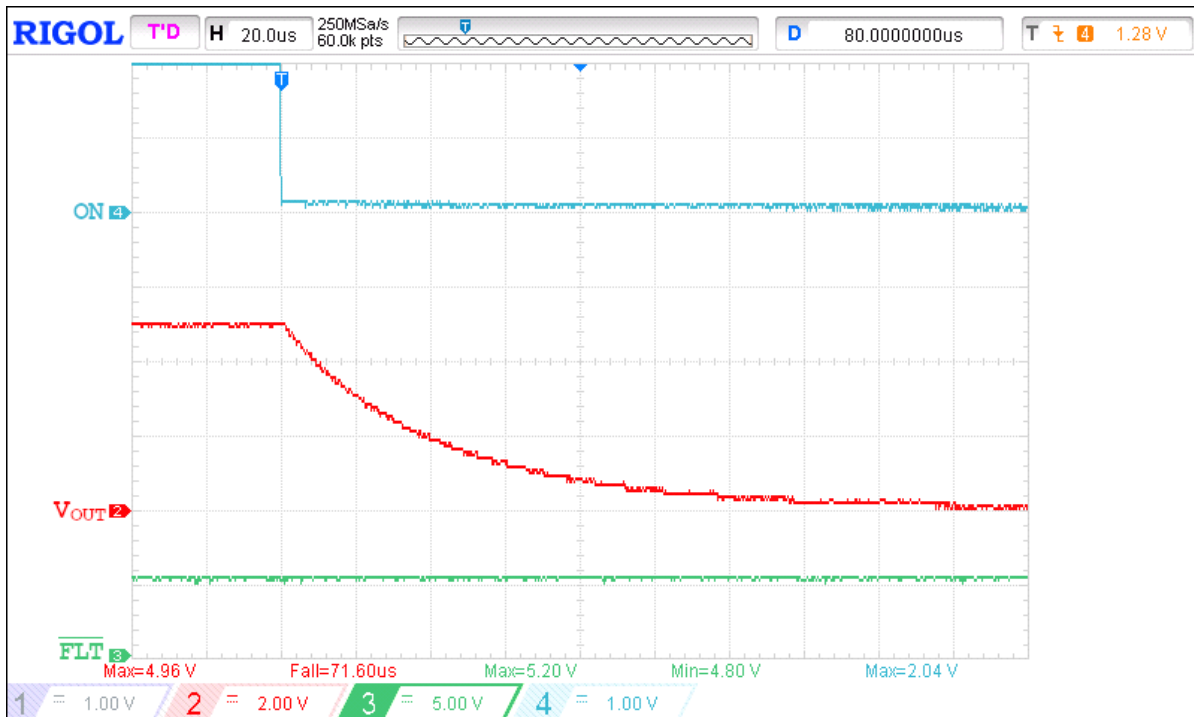

Figure 12. Typical Turn OFF operation waveform for $V_{IN} = 5\text{ V}$, $R_{LOAD} = 3.8\ \Omega$, $C_{LOAD} = 10\ \mu\text{F}$

SLG59H1341C

A Reverse Blocking 70 mΩ, 1.3 A nFET
Load Switch in 1.46 mm² WLCSP

Typical $\overline{\text{FLT}}$ Operation Waveforms

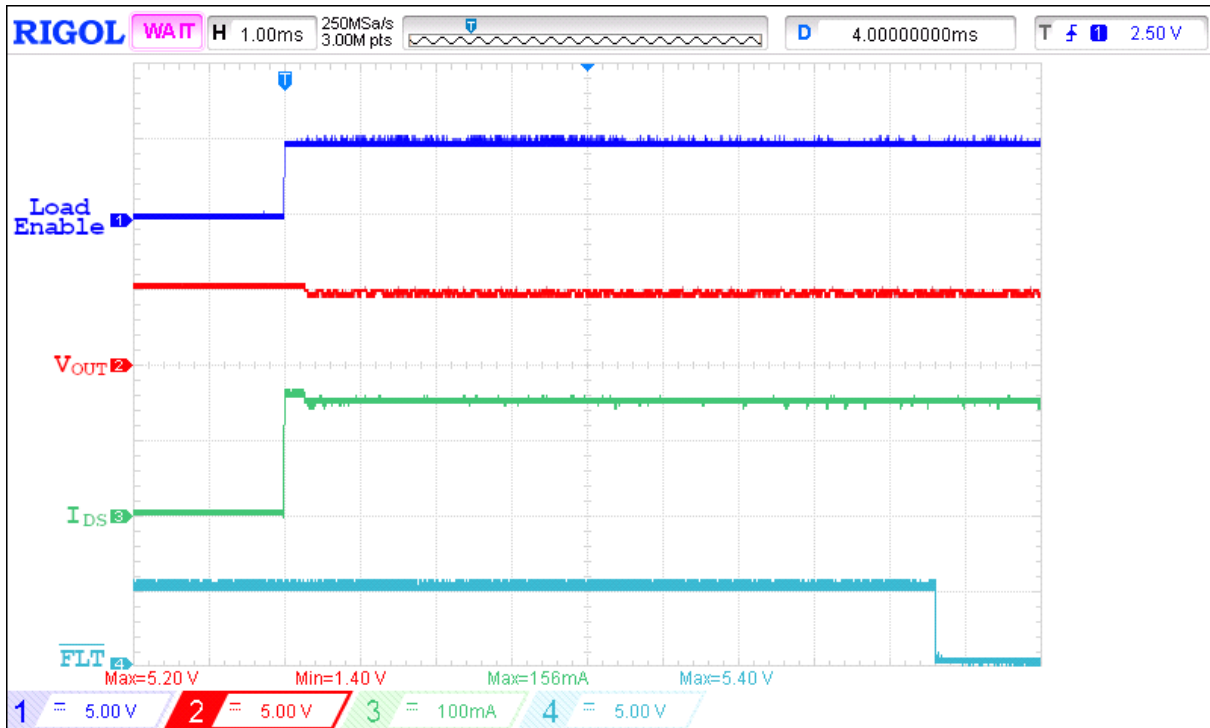

Figure 13. $\overline{\text{FLT}}$ assertion operation waveform for $V_{\text{IN}} = 5 \text{ V}$, $R_{\text{LOAD}} = 30 \Omega$, $R_{\text{SET}} = 6.49 \text{ k}\Omega$, $C_{\text{LOAD}} = 0.1 \mu\text{F}$

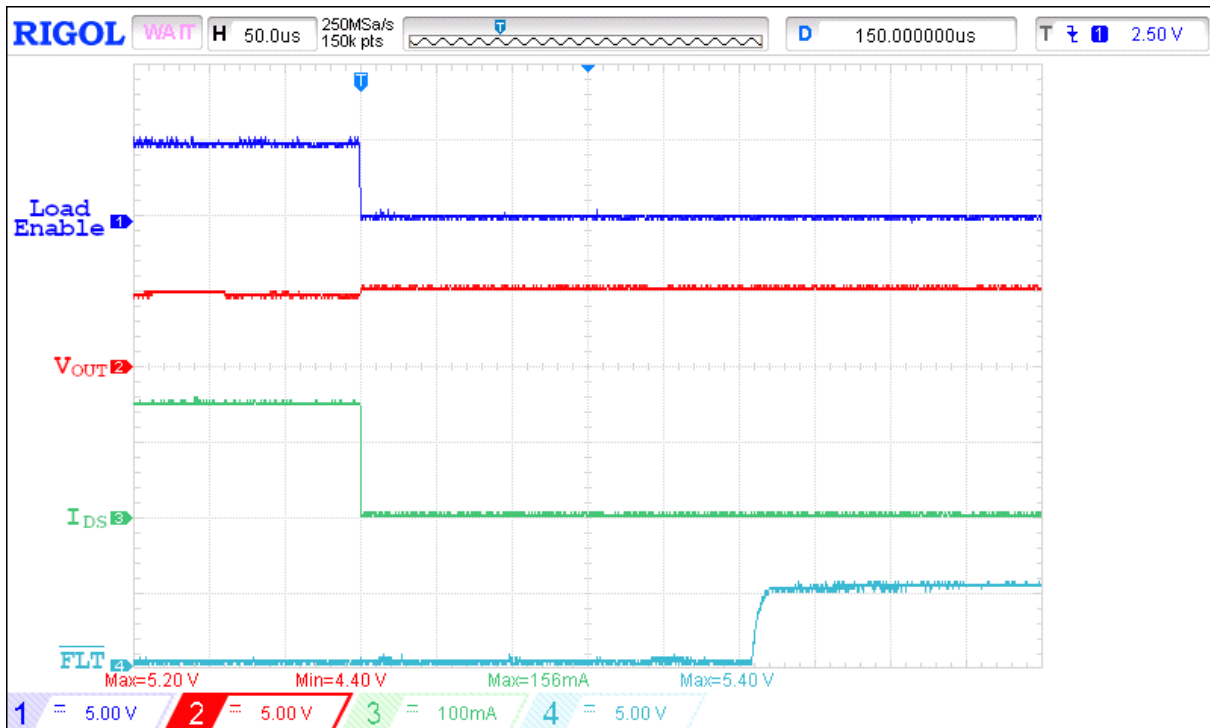

Figure 14. $\overline{\text{FLT}}$ de-assertion operation waveform for $V_{\text{IN}} = 5 \text{ V}$, $R_{\text{LOAD}} = 30 \Omega$, $R_{\text{SET}} = 6.49 \text{ k}\Omega$, $C_{\text{LOAD}} = 0.1 \mu\text{F}$

SLG59H1341C

A Reverse Blocking 70 mΩ, 1.3 A nFET
Load Switch in 1.46 mm² WLCSP

Typical ACL Operation Waveforms

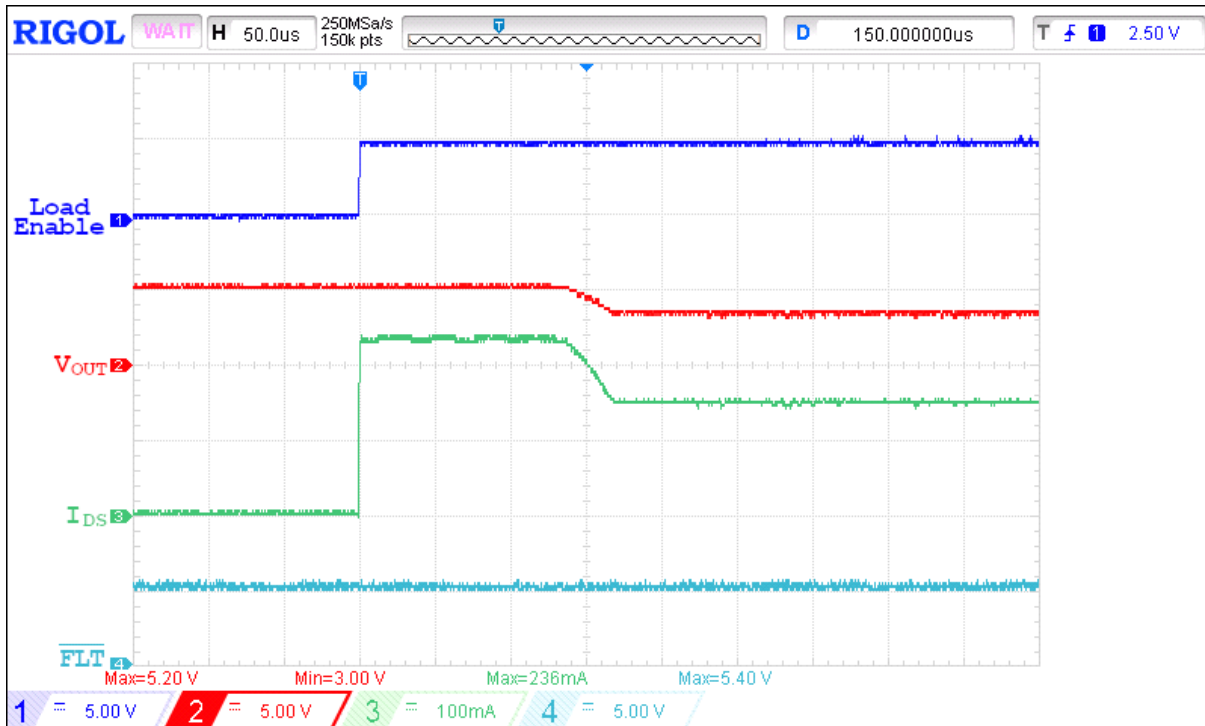

Figure 15. Typical ACL operation waveform for $V_{IN} = 5\text{ V}$, $R_{LOAD} = 22\ \Omega$, $R_{SET} = 6.49\text{ k}\Omega$, $C_{LOAD} = 0.1\ \mu\text{F}$

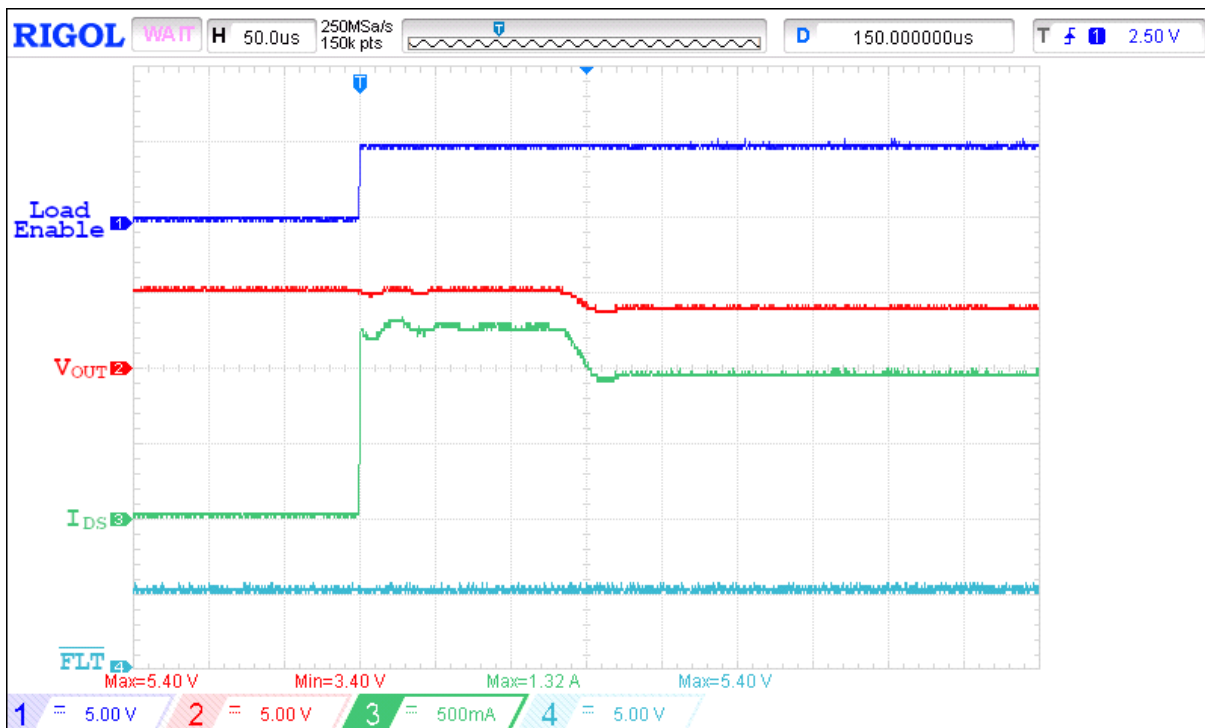

Figure 16. Typical ACL operation waveform for $V_{IN} = 5\text{ V}$, $R_{LOAD} = 3.9\ \Omega$, $R_{SET} = 1.07\text{ k}\Omega$, $C_{LOAD} = 0.1\ \mu\text{F}$

SLG59H1341C

A Reverse Blocking 70 mΩ, 1.3 A nFET
 Load Switch in 1.46 mm² WLCSP

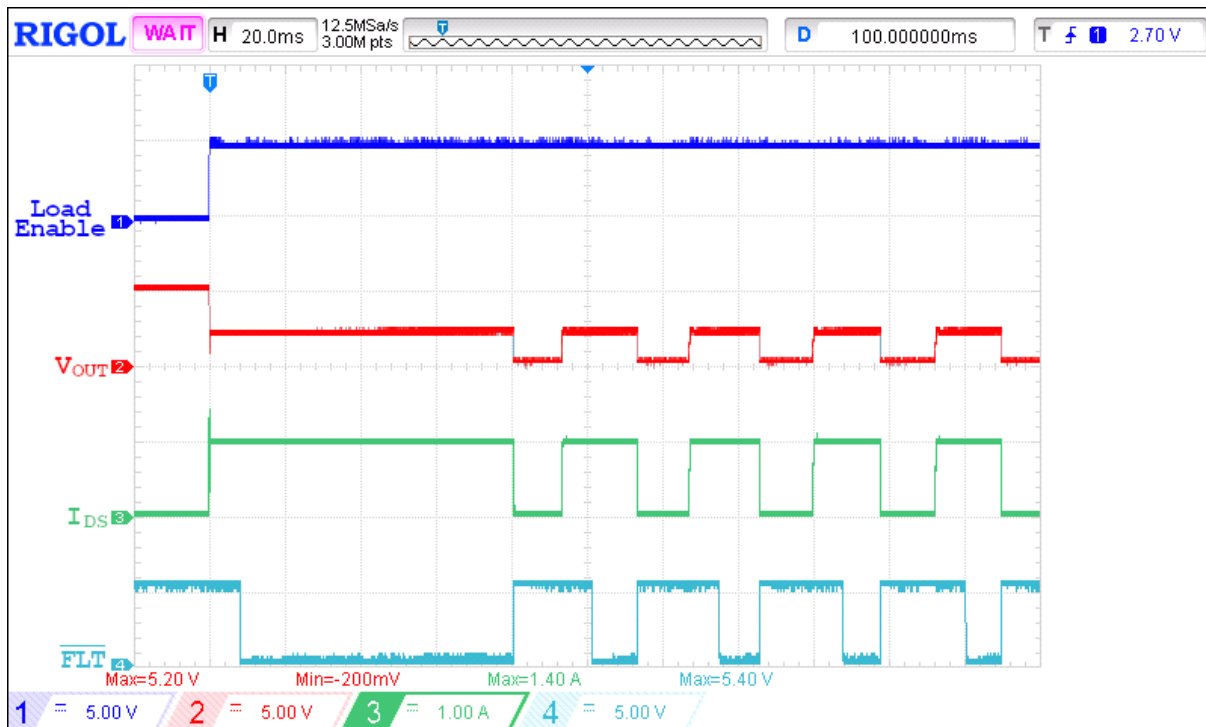

Figure 17. Typical ACL wit Thermal Shutdown Protection operation waveform for
 $V_{IN} = 5\text{ V}$, $R_{LOAD} = 2.2\ \Omega$, $R_{SET} = 1.07\ \text{k}\Omega$, $C_{LOAD} = 0.1\ \mu\text{F}$

SLG59H1341C

A Reverse Blocking 70 mΩ, 1.3 A nFET
Load Switch in 1.46 mm² WLCSP

Typical OVP Operation Waveforms

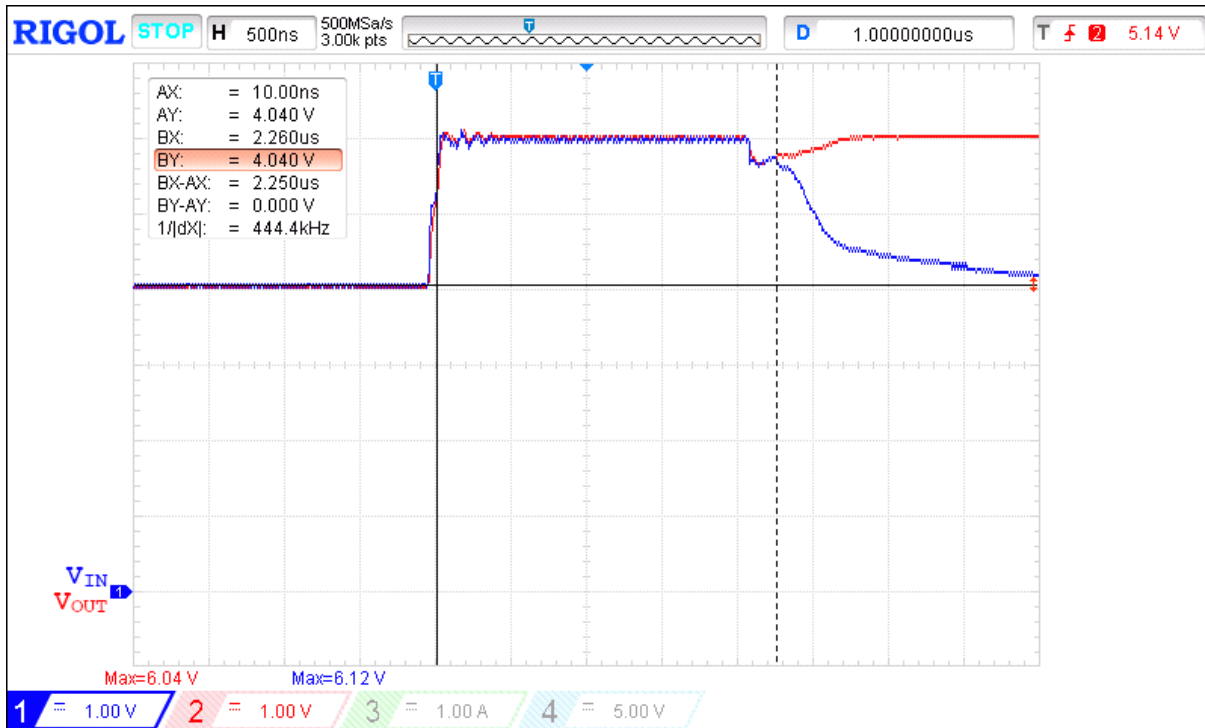

Figure 18. OVP Response operation waveform for V_{OUT} step from 4 V to 6 V, no R_{LOAD}, no C_{LOAD}

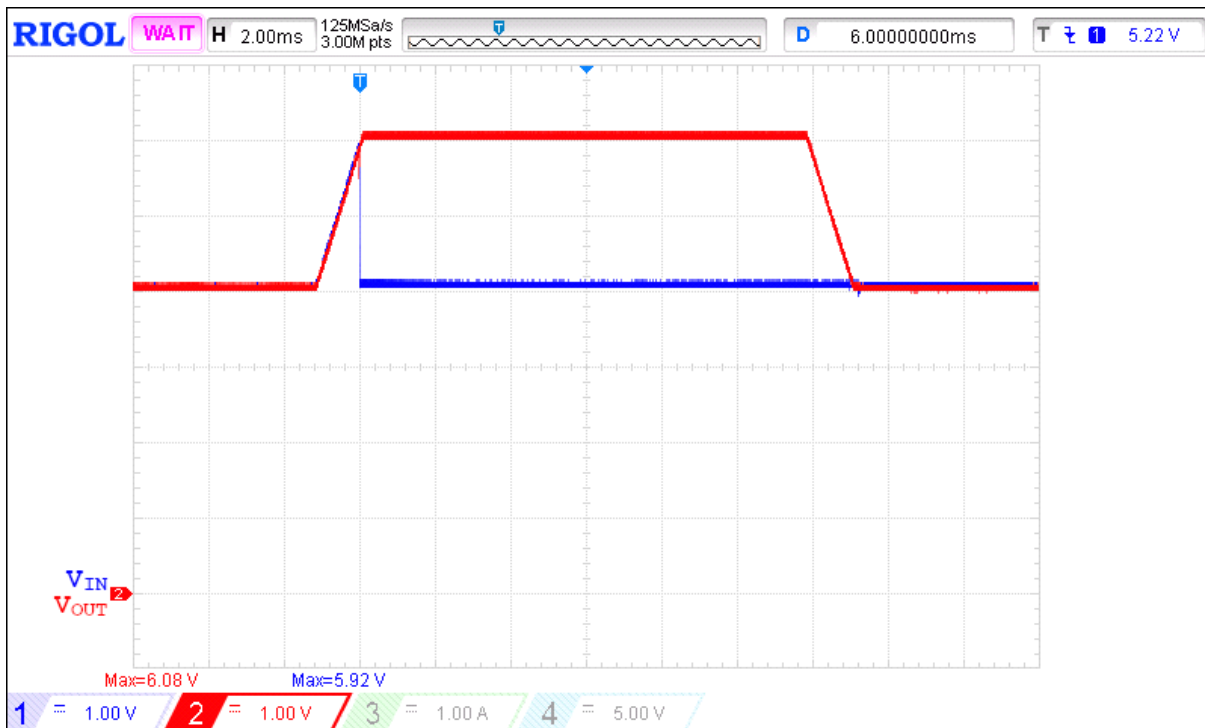

Figure 19. Typical Overtoltage Protection operation waveform.
V_{IN} = 4 V. V_{OUT} step from 4 V to 6 V to 4 V, no R_{LOAD}, no C_{LOAD}

SLG59H1341C

A Reverse Blocking 70 mΩ, 1.3 A nFET
Load Switch in 1.46 mm² WLCSP

SLG59H1341C Current Limiting Operation

After power up the output current is initially limited to the Active Current Limit (I_{ACL}) specification listed in the Electrical Characteristics table. The ACL monitor's response time is very fast and is triggered within a few microseconds to sudden (transient) changes in load current. When a load current overload is detected, the ACL monitor increases the FET resistance to keep the current from exceeding the load switch's I_{ACL} threshold. During active current-limit operation, V_{OUT} is also reduced by $I_{ACL} \times R_{DS_{ON(ACL)}}$.

When a current-limit event is detected, the \overline{FLT} signal becomes asserted in approximately $T_{\overline{FLT}_{LOW}}$ and the SLG59H1341C operates in constant current mode with the output current set by R_{SET} (see R_{SET} -Current Limit Table). The SLG59H1341C continues to operate in constant current mode indefinitely until the current-limit event has elapsed.

SLG59H1341C \overline{FLT} Operation

As previously stated in the Pin Description section, the open-drain \overline{FLT} output is asserted when an active-current limit (ACL) condition is detected. This output becomes asserted in $T_{\overline{FLT}_{LOW}}$ upon the detection of a fault condition. If the ON pin is toggled HIGH-to-LOW while the \overline{FLT} output is low, the \overline{FLT} output is deasserted without delay.

Setting the SLG59H1341C Output Current Limit with R_{SET}

The current-limit operation of the SLG59H1341C begins by choosing the appropriate $\pm 1\%$ -tolerance R_{SET} value for the application. The recommended range for R_{SET} is:

$$6.49 \text{ k}\Omega \geq R_{SET} \geq 680 \Omega$$

which corresponds to an output constant current limit in the following range:

$$0.16 \text{ A} \leq I_{ACL} \leq 1.62 \text{ A}$$

Table 1: Setting Current Limit Threshold vs. R_{SET} , $C_{IN} = 30 \mu\text{F}$, $C_{RSET} = 10 \text{ pF}$

$R_{SET} (\Omega)$	Min. Current Limit (A)	Typ. Current Limit (A)	Max. Current Limit (A)
680	1.460	1.620	1.780
866	1.140	1.260	1.380
1070	0.920	1.020	1.120
1200	0.820	0.910	1.000
1330	0.730	0.810	0.890
1500	0.650	0.720	0.790
1740	0.560	0.620	0.680
2100	0.460	0.510	0.560
2320	0.414	0.460	0.506
2550	0.374	0.415	0.456
2940	0.329	0.365	0.401
3400	0.284	0.315	0.346
4020	0.239	0.265	0.291
4990	0.194	0.215	0.236
6490	0.136	0.160	0.184

SLG59H1341C

A Reverse Blocking 70 mΩ, 1.3 A nFET Load Switch in 1.46 mm² WLCSP

Power Dissipation Considerations

The junction temperature of the SLG59H1341C depends on factors such as board layout, ambient temperature, external air flow over the package, load current, and the RDS_{ON} generated voltage drop across each power MOSFET. While the primary contributor to the increase in the junction temperature of the SLG59H1341C is the power dissipation of its power MOSFETs, its power dissipation and the junction temperature in nominal operating mode can be calculated using the following equations:

$$PD_{TOTAL} = RDS_{ON} \times I_{DS}^2$$

where:

PD_{TOTAL} = Total package power dissipation, in Watts (W)

RDS_{ON} = Power MOSFET ON resistance, in Ohms (Ω)

I_{DS} = Output current, in Amps (A)

and

$$T_J = PD_{TOTAL} \times \theta_{JA} + T_A$$

where:

T_J = Die junction temperature, in Celsius degrees (°C)

θ_{JA} = Package thermal resistance, in Celsius degrees per Watt (°C/W) – highly dependent on pcb layout

T_A = Ambient temperature, in Celsius degrees (°C)

In nominal operating mode, the SLG59H1341C's power dissipation can also be calculated by taking into account the voltage drop across the switch (V_{IN} - V_{OUT}) and the magnitude of the switch's output current (I_{DS}):

$$PD_{TOTAL} = (V_{IN} - V_{OUT}) \times I_{DS} \text{ or}$$

$$PD_{TOTAL} = (V_{IN} - (R_{LOAD} \times I_{DS})) \times I_{DS}$$

where:

PD_{TOTAL} = Total package power dissipation, in Watts (W)

V_{IN} = Switch input Voltage, in Volts (V)

R_{LOAD} = Output Load Resistance, in Ohms (Ω)

I_{DS} = Switch output current, in Amps (A)

V_{OUT} = Switch output voltage, or R_{LOAD} × I_{DS}

In current-limit mode, the SLG59H1341C's power dissipation can be calculated by taking into account the voltage drop across the load switch (V_{IN}-V_{OUT}) and the magnitude of the output current in current-limit mode (I_{ACL}):

$$PD = (V_{IN} - V_{OUT}) \times I_{ACL} \text{ or}$$

$$PD = (V_{IN} - (R_{LOAD} \times I_{ACL})) \times I_{ACL}$$

where:

PD = Power dissipation, in Watts (W)

V_{IN} = Input Voltage, in Volts (V)

R_{LOAD} = Load Resistance, in Ohms (Ω)

I_{ACL} = Output limited current, in Amps (A)

V_{OUT} = R_{LOAD} × I_{ACL}

SLG59H1341C

A Reverse Blocking 70 mΩ, 1.3 A nFET
Load Switch in 1.46 mm² WLCSP

Layout Guidelines

1. Since the VIN and VOUT pins dissipate most of the heat generated during high-load current operation, it is highly recommended to make power traces as short, direct, and wide as possible. A good practice is to make power traces with an absolute minimum widths of 15 mils (0.381 mm) per Ampere. A representative layout, shown in Figure 20, illustrates proper techniques for heat to transfer as efficiently as possible out of the device;
2. To minimize the effects of parasitic trace inductance on normal operation, it is recommended to connect input C_{IN} and output C_{LOAD} low-ESR capacitors as close as possible to the SLG59H1341Cs VIN and VOUT pins;
3. The GND pin should be connected to system analog or power ground plane.

SLG59H1341C Evaluation Board:

4. A High Voltage GreenFET Evaluation Board for SLG59H1341C is designed according to the statements above and is illustrated on Figure 20. Please note that evaluation board Sense pads. They cannot carry high currents and dedicated only for RDS_{ON} evaluation.

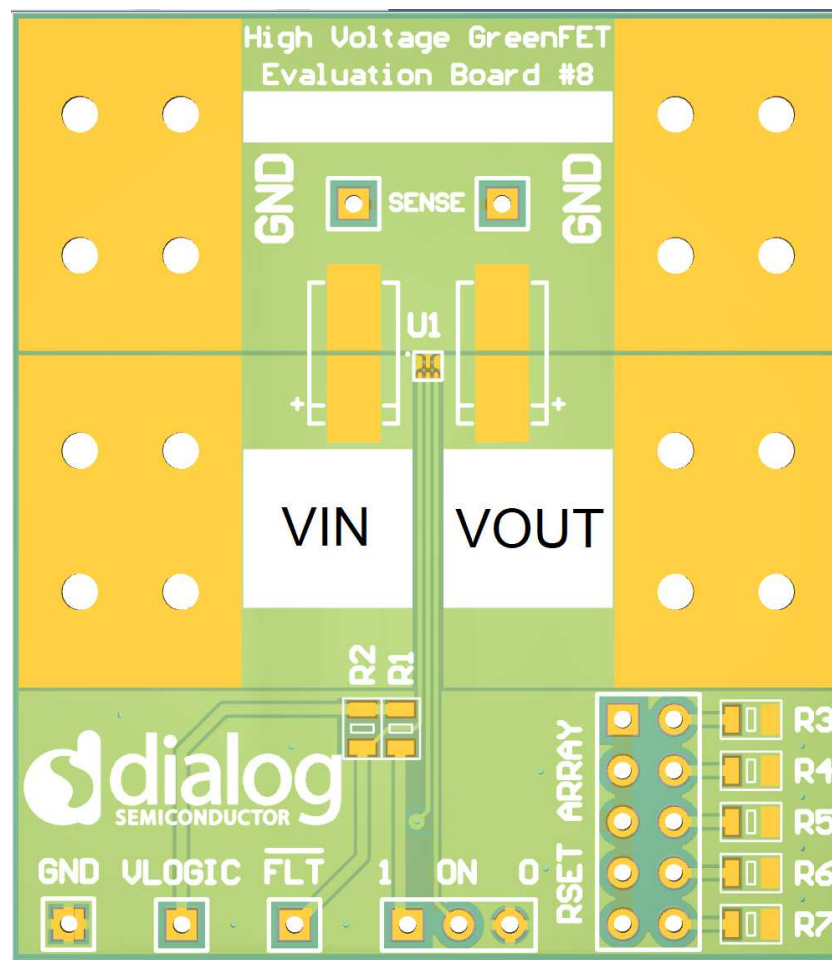

Figure 20. SLG59H1341C Evaluation Board

SLG59H1341C

A Reverse Blocking 70 mΩ, 1.3 A nFET
Load Switch in 1.46 mm² WLCSP

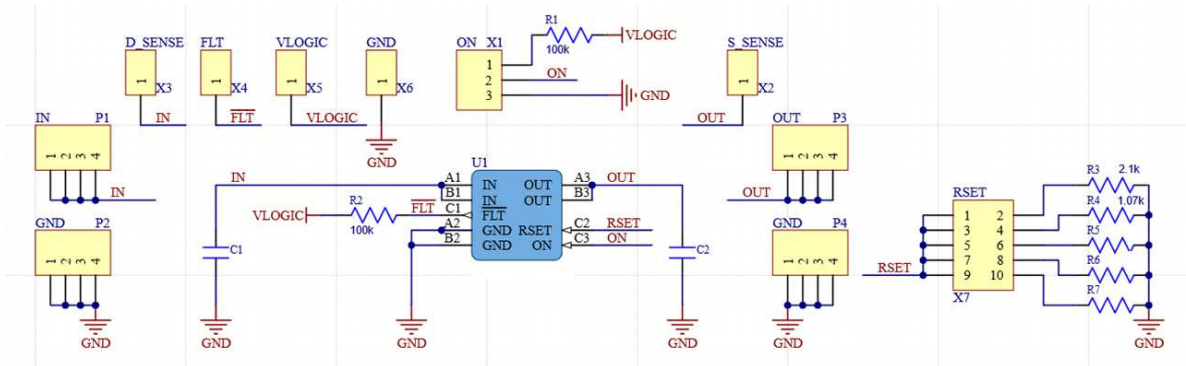

Figure 21. SLG59H1341C Evaluation Board Connection Circuit

Basic EVB Configuration

1. Connect oscilloscope probes to VIN, VOUT, ON, etc.;
2. Turn on Power Supply and set desired V_{IN} from 2.5 V...5.5 V range;
3. Toggle ON signal High or Low to observe SLG59H1341C operation;

SLG59H1341C

A Reverse Blocking 70 mΩ, 1.3 A nFET
Load Switch in 1.46 mm² WLCSP

Package Top Marking System Definition

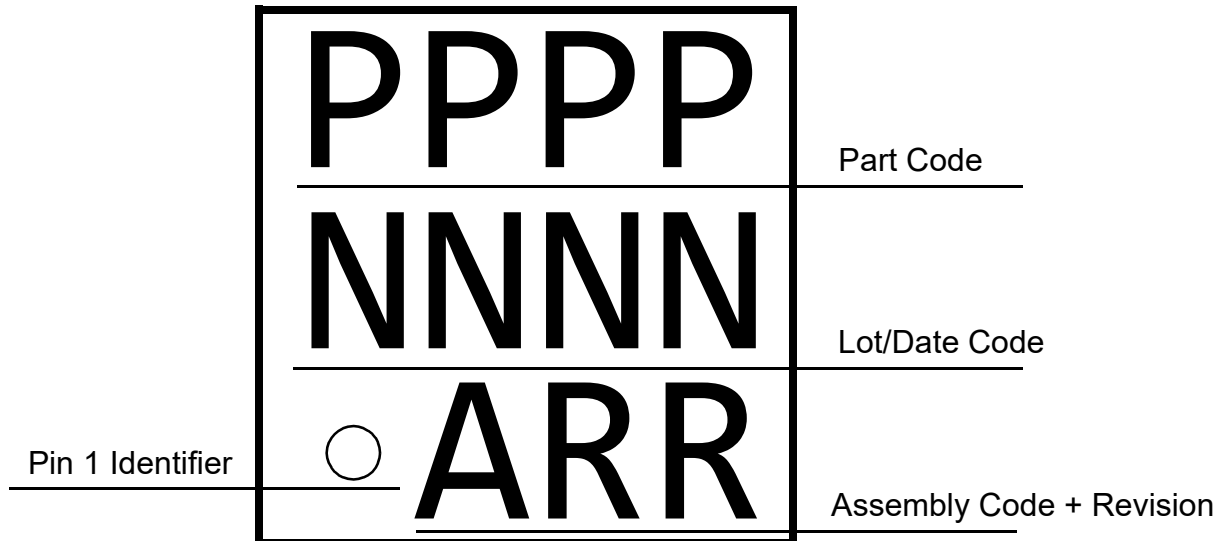

SLG59H1341C

A Reverse Blocking 70 mΩ, 1.3 A nFET
Load Switch in 1.46 mm² WLCSP

Package Drawing and Dimensions

9 Pin WLCSP Green Package 1.21x 1.21 mm

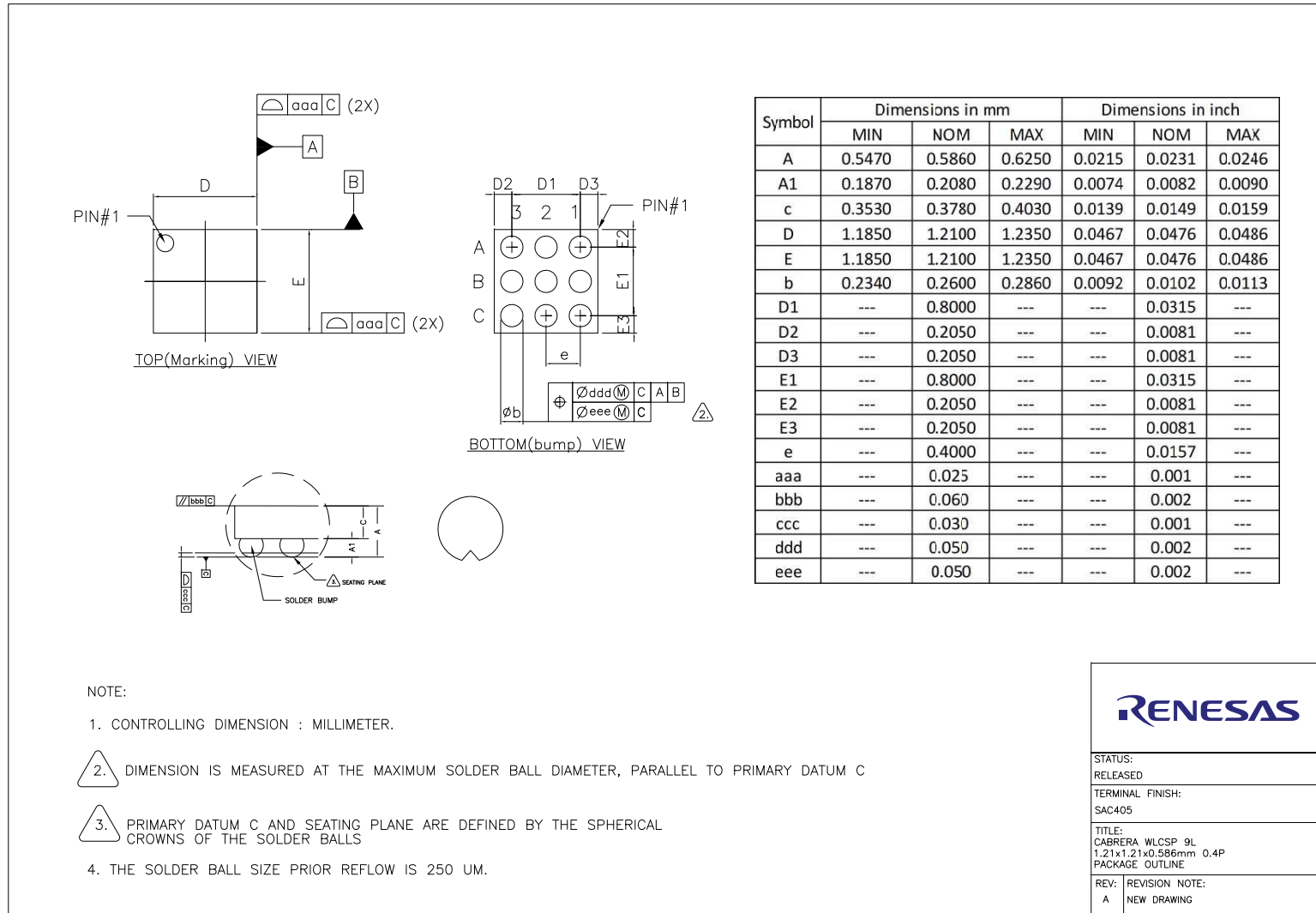

SLG59H1341C

A Reverse Blocking 70 mΩ, 1.3 A nFET
Load Switch in 1.46 mm² WLCSP

Recommended Landing Pattern

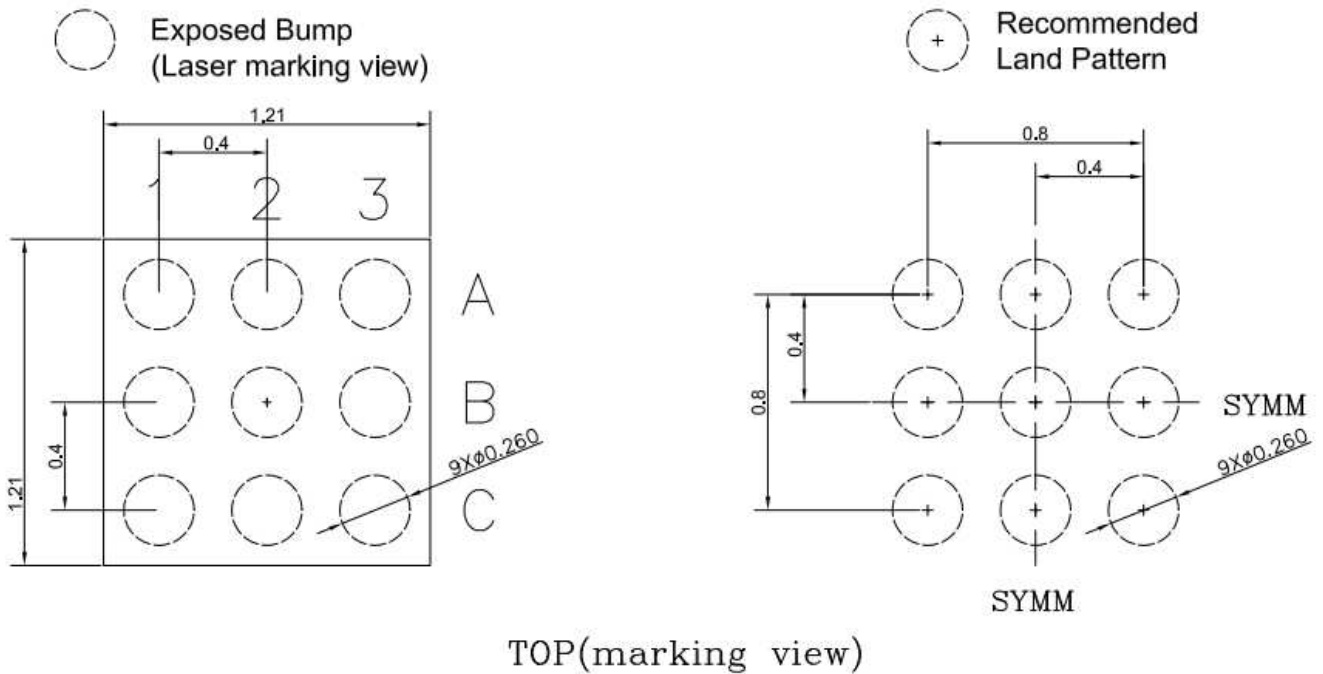

SLG59H1341C

A Reverse Blocking 70 mΩ, 1.3 A nFET
Load Switch in 1.46 mm² WLCSP

Recommended Reflow Soldering Profile

For successful reflow of the SLG59H1341C a recommended thermal profile is illustrated below:

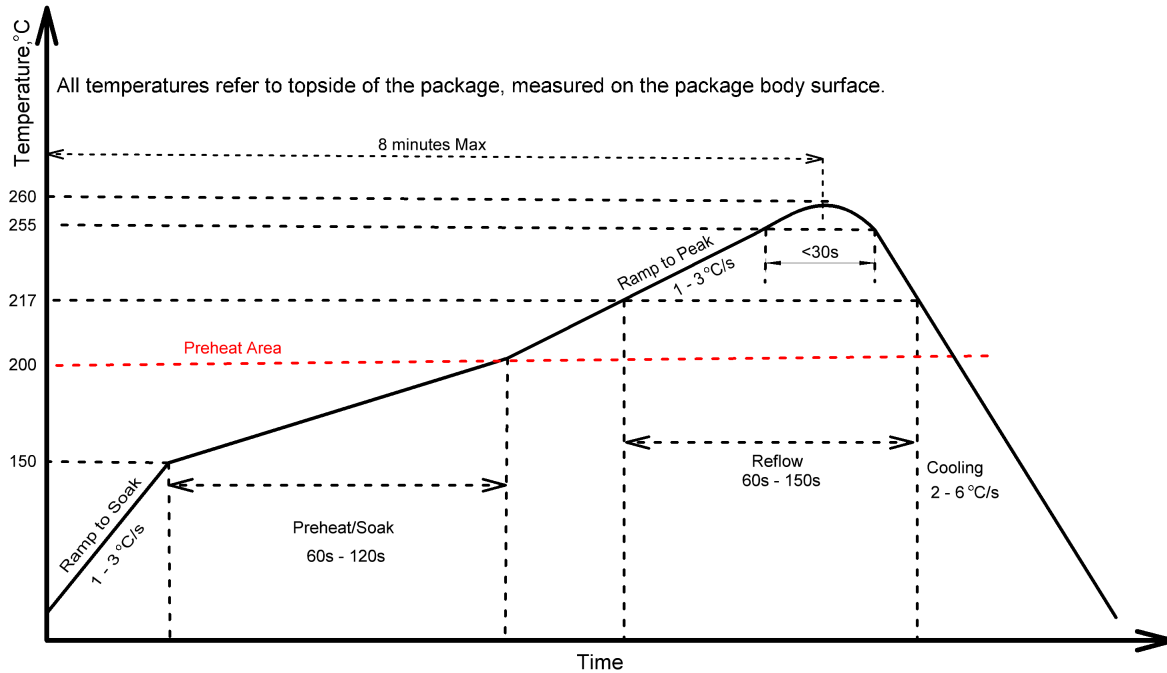

Note: This reflow profile is for classification/preconditioning and are not meant to specify board assembly profile. Actual board assembly profiles should be developed based on specific process needs and board designs and should not exceed parameters depicted on figure above.

Please see more information on IPC/JEDEC J-STD-020: latest revision for reflow profile based on package volume of 0.553 mm³ (nominal).

SLG59H1341C

A Reverse Blocking 70 mΩ, 1.3 A nFET
Load Switch in 1.46 mm² WLCSP

Tape and Reel Specifications

Package Type	# of Pins	Nominal Package Size [mm]	Max Units		Reel & Hub Size [mm]	Leader (min)		Trailer (min)		Tape Width [mm]	Part Pitch [mm]
			per Reel	per Box		Pockets	Length [mm]	Pockets	Length [mm]		
WLCSP9L 1.21x1.21 mm 0.4P Green	9	1.21 x 1.21 x 0.586	3,000	3,000	178 / 60	100	400	100	400	8	4

Carrier Tape Drawing and Dimensions

Package Type	Pocket BTM Length	Pocket BTM Width	Pocket Depth	Index Hole Pitch	Pocket Pitch	Index Hole Diameter	Index Hole to Tape Edge	Index Hole to Pocket Center	Tape Width	Tape Thickness
	A0	B0	K0	P0	P1	D0	E	F	W	T
WLCSP 9L 1.21x 1.21 mm 0.4P Green	1.38	1.38	0.7	4	4	1.5	1.75	3.5	8	0.2

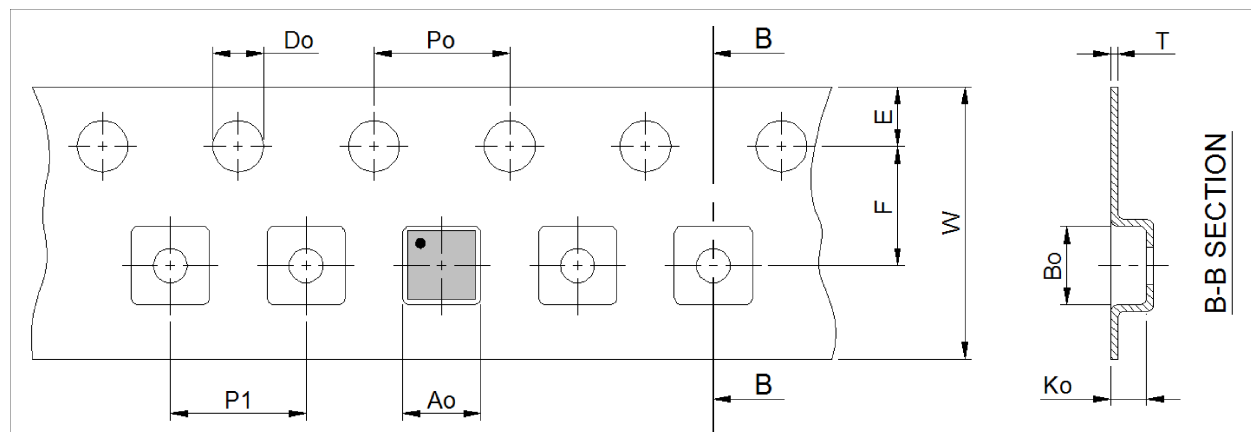

Note: 1.Orientation in carrier: Pin1 is at upper left corner (Quadrant 1).

Refer to EIA-481 specification

SLG59H1341C

A Reverse Blocking 70 mΩ, 1.3 A nFET
Load Switch in 1.46 mm² WLCSP

Revision History

Date	Version	Change
18-Jul-2022	1.0	Production Release

IMPORTANT NOTICE AND DISCLAIMER

RENESAS ELECTRONICS CORPORATION AND ITS SUBSIDIARIES (“RENESAS”) PROVIDES TECHNICAL SPECIFICATIONS AND RELIABILITY DATA (INCLUDING DATASHEETS), DESIGN RESOURCES (INCLUDING REFERENCE DESIGNS), APPLICATION OR OTHER DESIGN ADVICE, WEB TOOLS, SAFETY INFORMATION, AND OTHER RESOURCES “AS IS” AND WITH ALL FAULTS, AND DISCLAIMS ALL WARRANTIES, EXPRESS OR IMPLIED, INCLUDING, WITHOUT LIMITATION, ANY IMPLIED WARRANTIES OF MERCHANTABILITY, FITNESS FOR A PARTICULAR PURPOSE, OR NON-INFRINGEMENT OF THIRD-PARTY INTELLECTUAL PROPERTY RIGHTS.

These resources are intended for developers who are designing with Renesas products. You are solely responsible for (1) selecting the appropriate products for your application, (2) designing, validating, and testing your application, and (3) ensuring your application meets applicable standards, and any other safety, security, or other requirements. These resources are subject to change without notice. Renesas grants you permission to use these resources only to develop an application that uses Renesas products. Other reproduction or use of these resources is strictly prohibited. No license is granted to any other Renesas intellectual property or to any third-party intellectual property. Renesas disclaims responsibility for, and you will fully indemnify Renesas and its representatives against, any claims, damages, costs, losses, or liabilities arising from your use of these resources. Renesas' products are provided only subject to Renesas' Terms and Conditions of Sale or other applicable terms agreed to in writing. No use of any Renesas resources expands or otherwise alters any applicable warranties or warranty disclaimers for these products.

(Disclaimer Rev.1.01 Jan 2024)

Corporate Headquarters

TOYOSU FORESIA, 3-2-24 Toyosu,
Koto-ku, Tokyo 135-0061, Japan
www.renesas.com

Trademarks

Renesas and the Renesas logo are trademarks of Renesas Electronics Corporation. All trademarks and registered trademarks are the property of their respective owners.

Contact Information

For further information on a product, technology, the most up-to-date version of a document, or your nearest sales office, please visit www.renesas.com/contact-us/.