

POWERNAVIGATOR 5.4

DIGITAL POINT OF LOAD USER GUIDE

MARCH 2018

BIG IDEAS
FOR EVERY SPACE

OVERVIEW

- This guide walks a user through the steps to setup and configure a digital power device using Renesas's PowerNavigator GUI.
- For Digital Multiphase products (ISL691xx and ISL681xx), please see the dedicated Digital Multiphase user guide.
- This guide assumes the user has followed the instructions on the website for downloading and installing PowerNavigator and is able to launch the program successfully.

OVERVIEW

- **The following sections are shown in this guide:**
 - **Hardware free mode**
 - Selection of devices
 - Power architecture setup
 - Current sharing
 - **Connecting to hardware**
 - Auto scan of devices
 - **Device setup with Rail Inspector**
 - Changing device parameters
 - Configuration file load and save
 - **Sequencing**
 - Time based sequencing
 - Event based sequencing
 - **RailScope**
 - Adding/monitoring devices
 - Logging
 - **Production File HEX Creation**

Offline Mode (Hardware Free Mode)

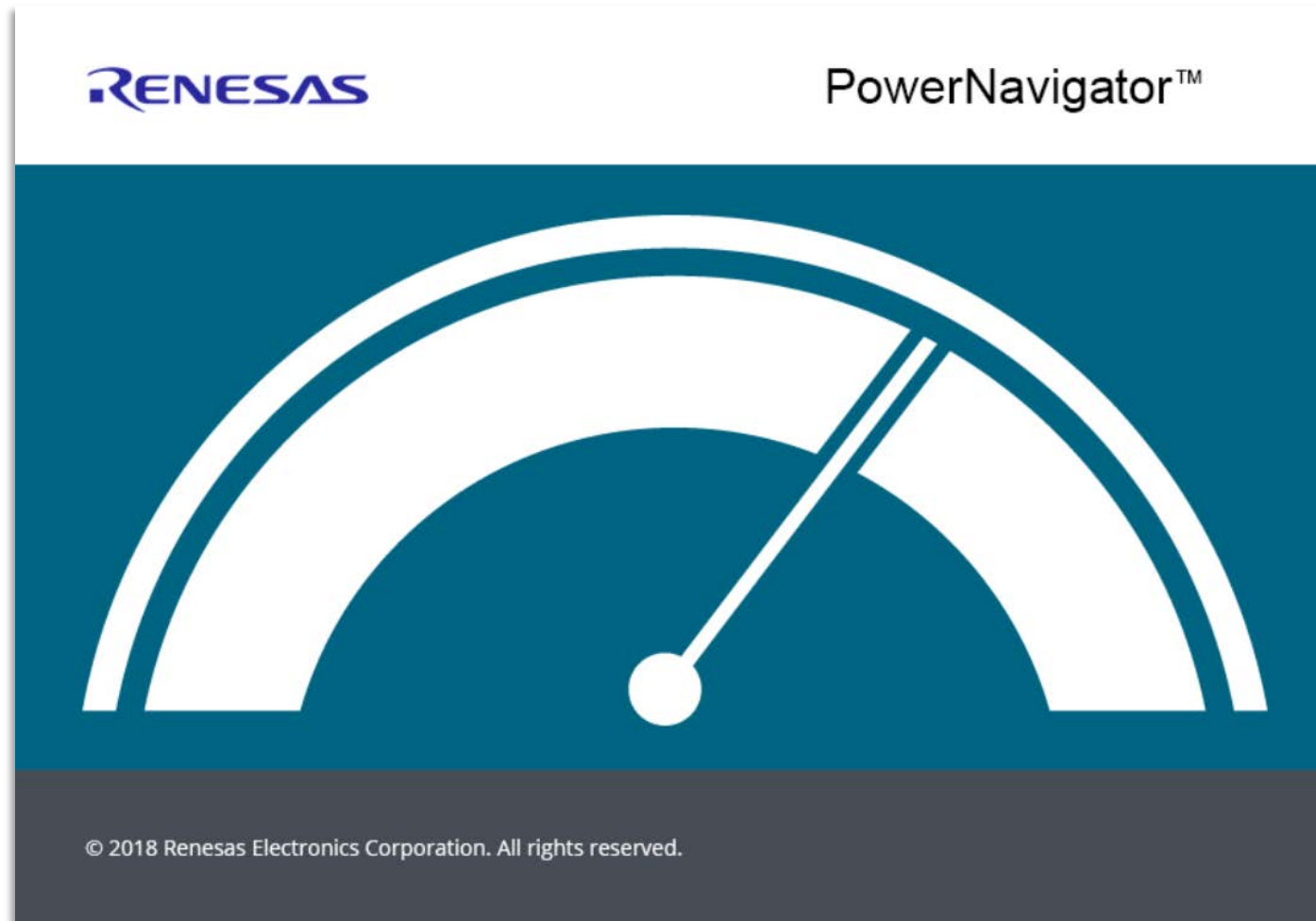

PowerNavigator Launch Screen – Offline Mode

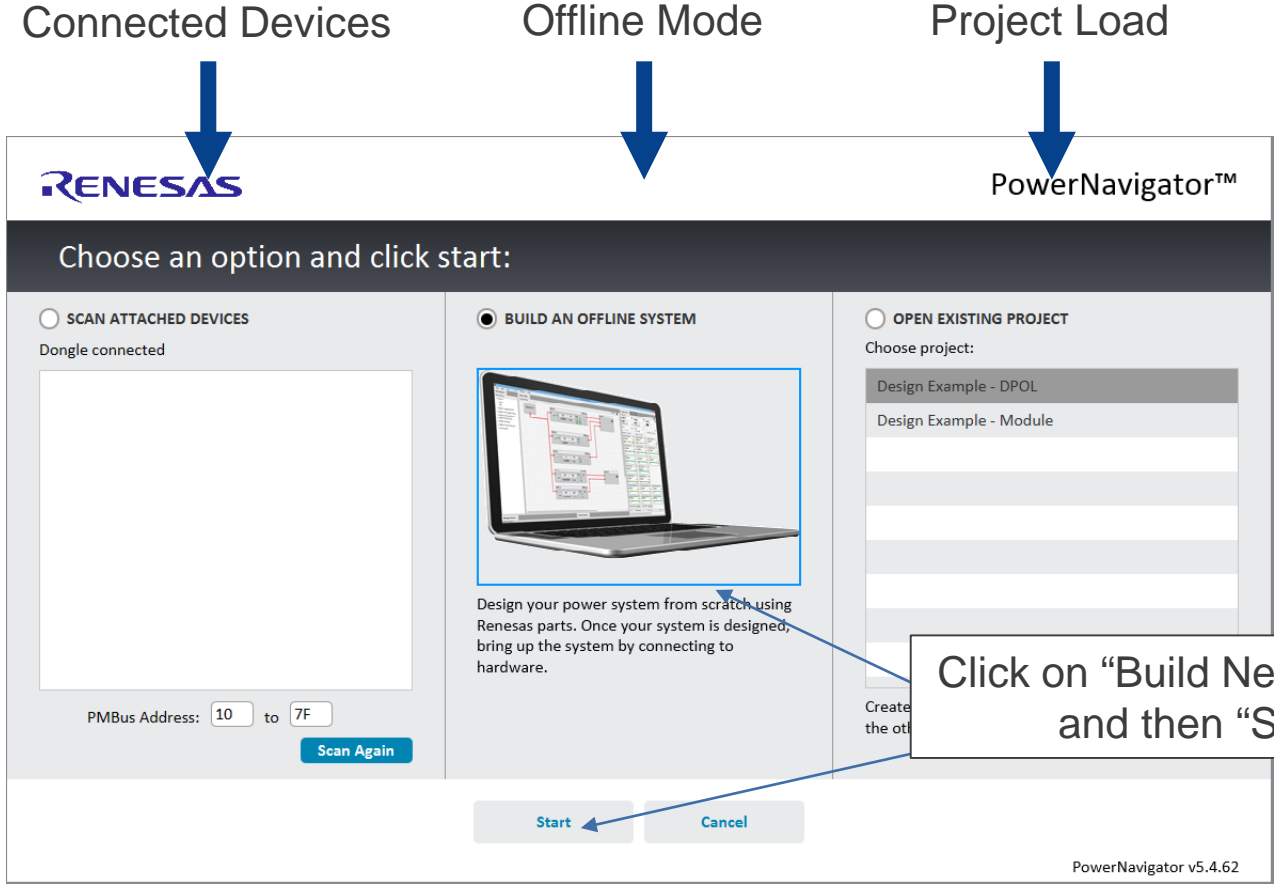

The PowerNavigator launch screen allows you to select online (hardware connected) or offline modes of operation.

PowerNavigator – System Screen Offline Mode

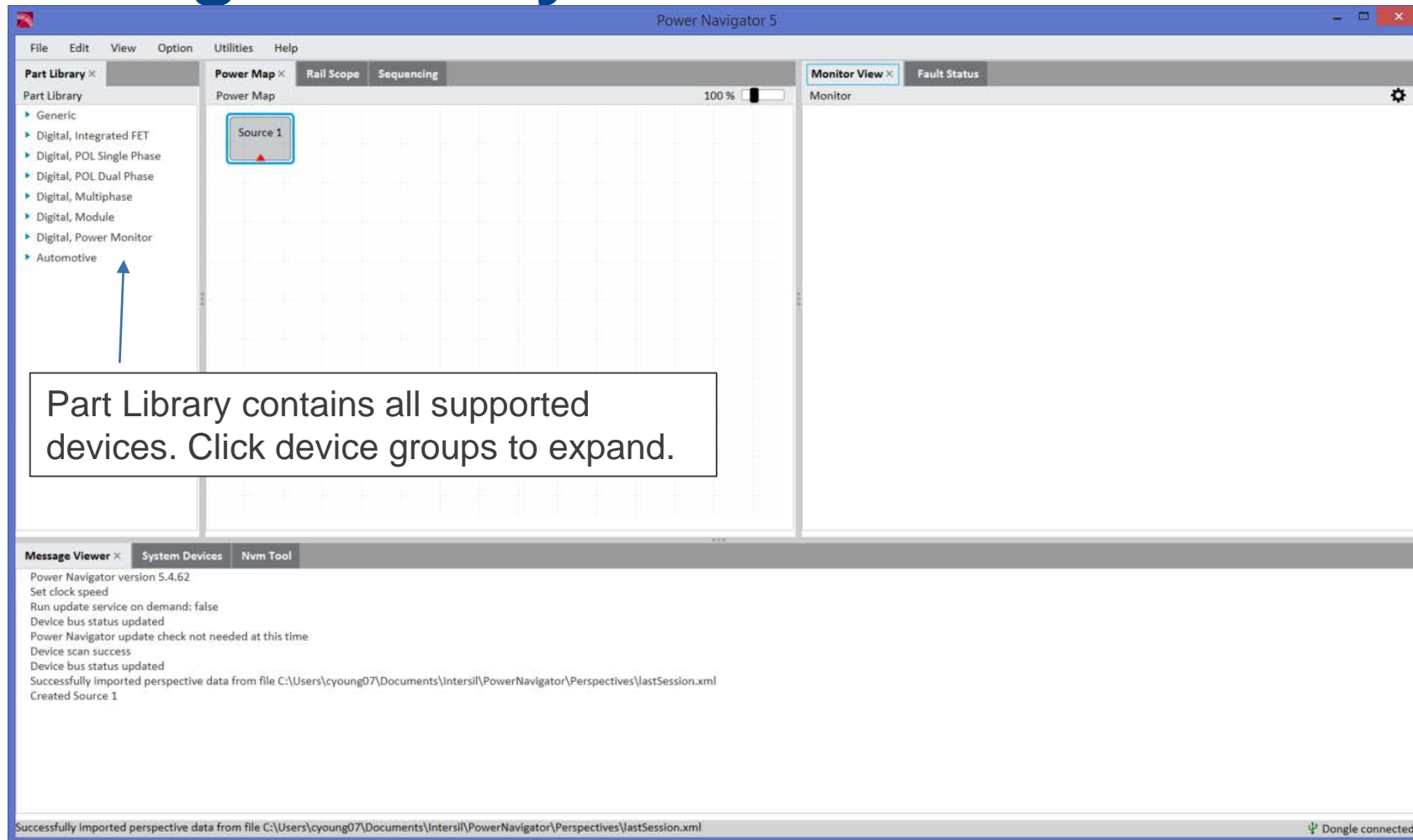

PowerNavigator – System Screen Offline Mode

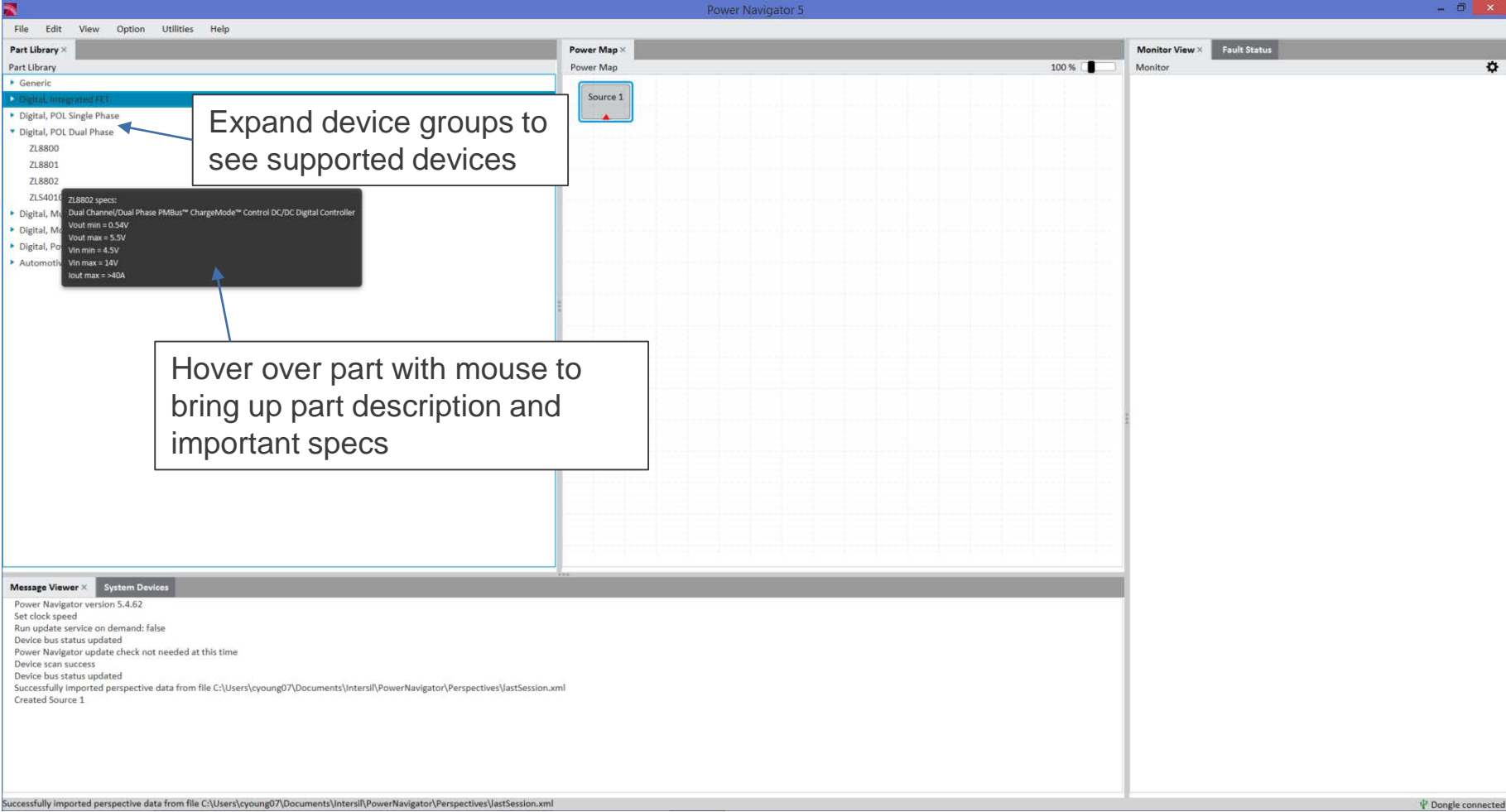

PowerNavigator – System Screen Offline Mode

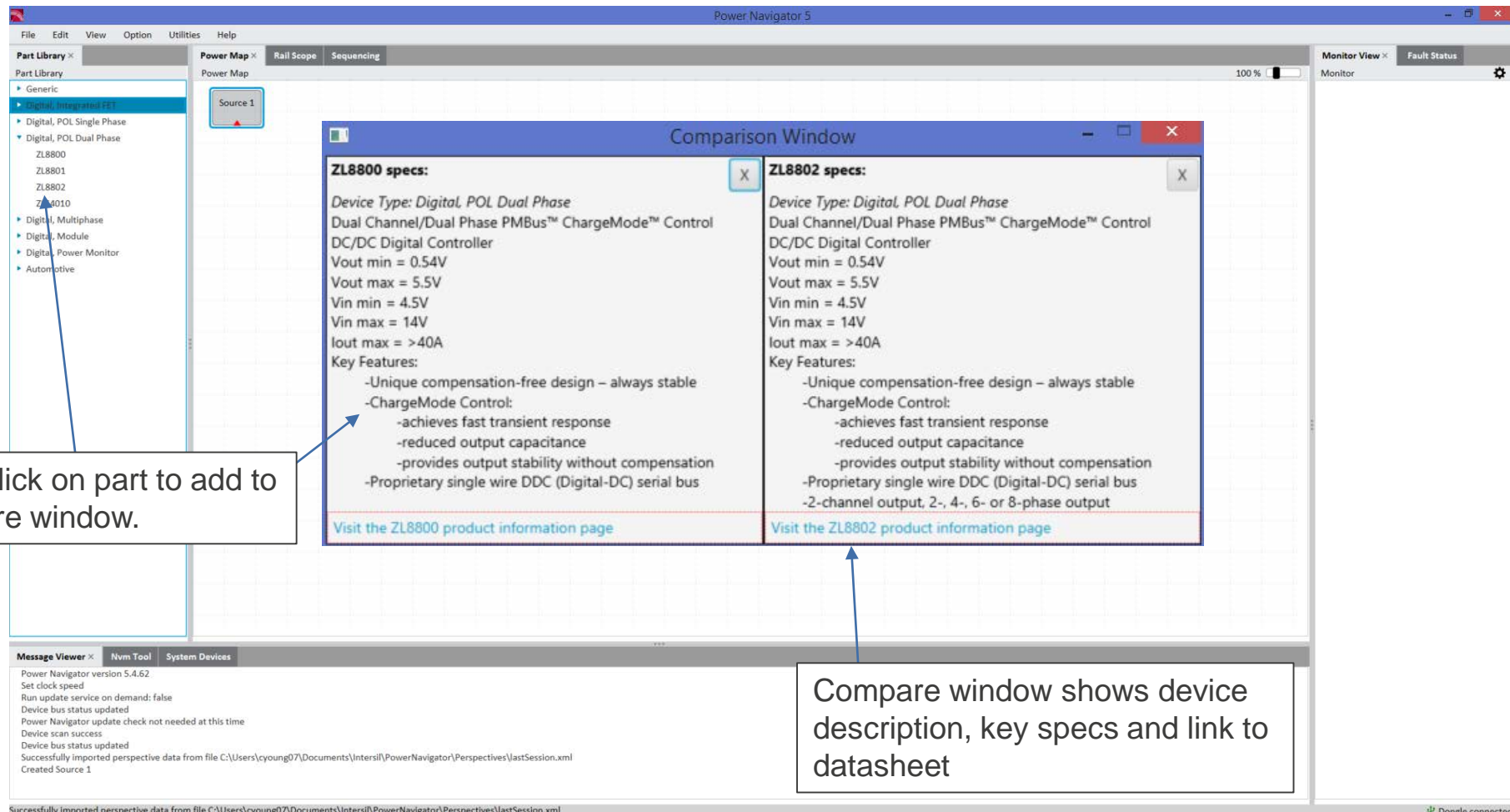

PowerNavigator – System Screen

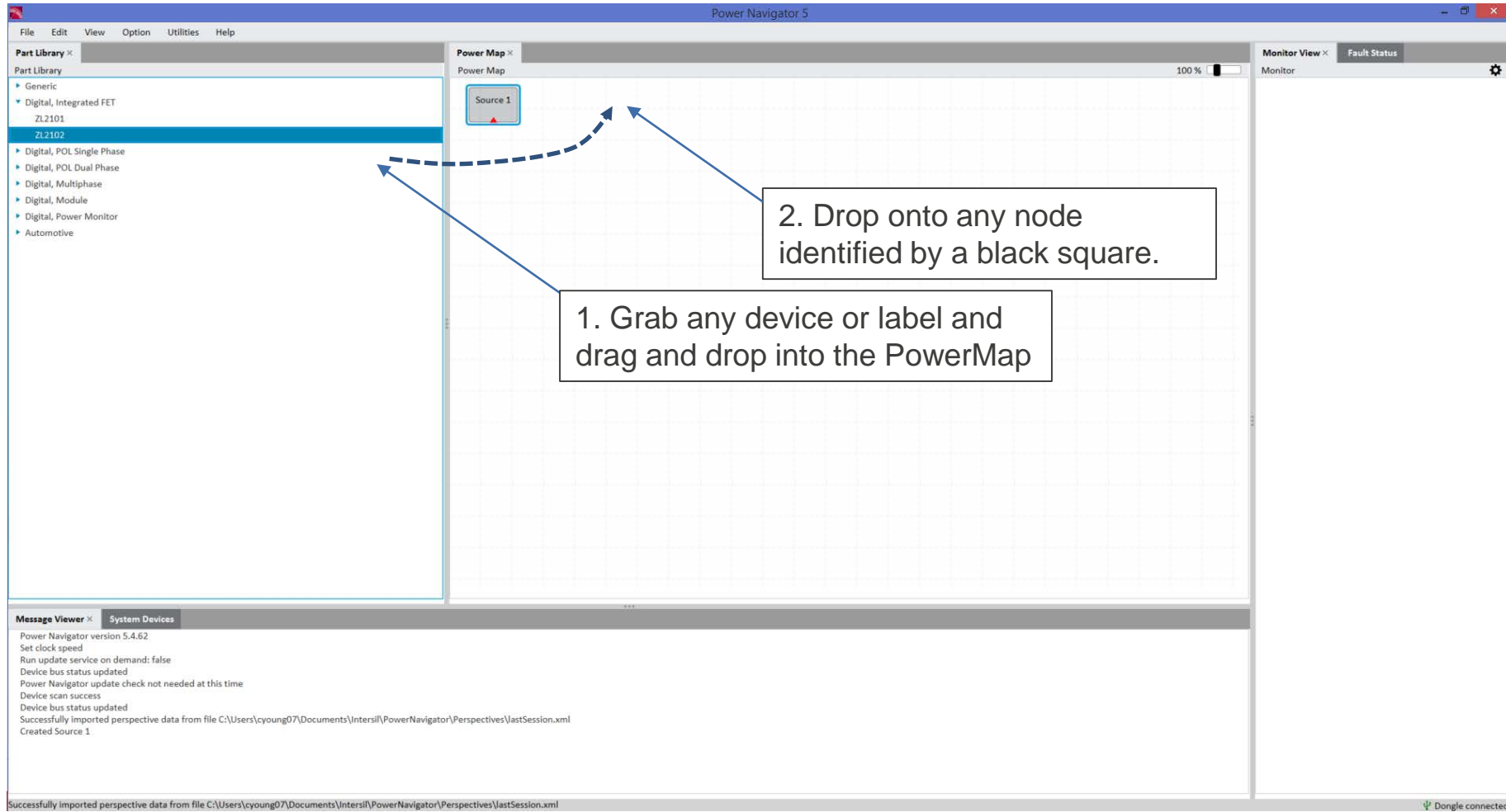

PowerNavigator – System Screen

The screenshot displays the PowerNavigator 5 software interface. The main workspace is titled "Power Map" and shows a diagram with a "Source 1" node on the left and a "Rail 0" node in the center. The "Rail 0" node is a ZL2102 converter with a "PG" (Power Good) indicator, "0V" and "0A" readouts, and an "Addr: 20" field. A dashed blue arrow points from the "Source 1" node to the "Rail 0" node, and a solid blue arrow points from the "Rail 0" node to an "Offline" node on the right. A text box with an arrow pointing to the "Rail 0" node contains the text "Drop parts on this node to cascade rails". Another text box with an arrow pointing to the connection line between "Source 1" and "Rail 0" contains the text "Additional rails can be added". A third text box at the bottom of the workspace contains the text "Layout assistant will automatically appear when adding parts to PowerMap".

The right-hand side of the interface features a "Monitor View" panel with the following data:

- Rail 0**: Device Address 0x20, Power Good Off, Vout 3.3 V, Pin Enable dropdown, Immediate Off dropdown, Margin Nominal dropdown.
- Output Voltage**: 0.00 V, range 2.81 to 3.79.
- Input Voltage**: 0.00 V, range 2.71 to 15.88.
- Output Current**: 0.00 A, range -28 to 28.
- Internal Temperature**: 0.00 C, range -65 to 135.
- Duty Cycle**: 0.0 %.
- Fsw**: 0.0 kHz.

The bottom of the interface shows a "Message Viewer" and "System Devices" section with a table:

Devices	Memory	Action
ZL2102 0x20	User	Store Restore

PowerNavigator – System Screen

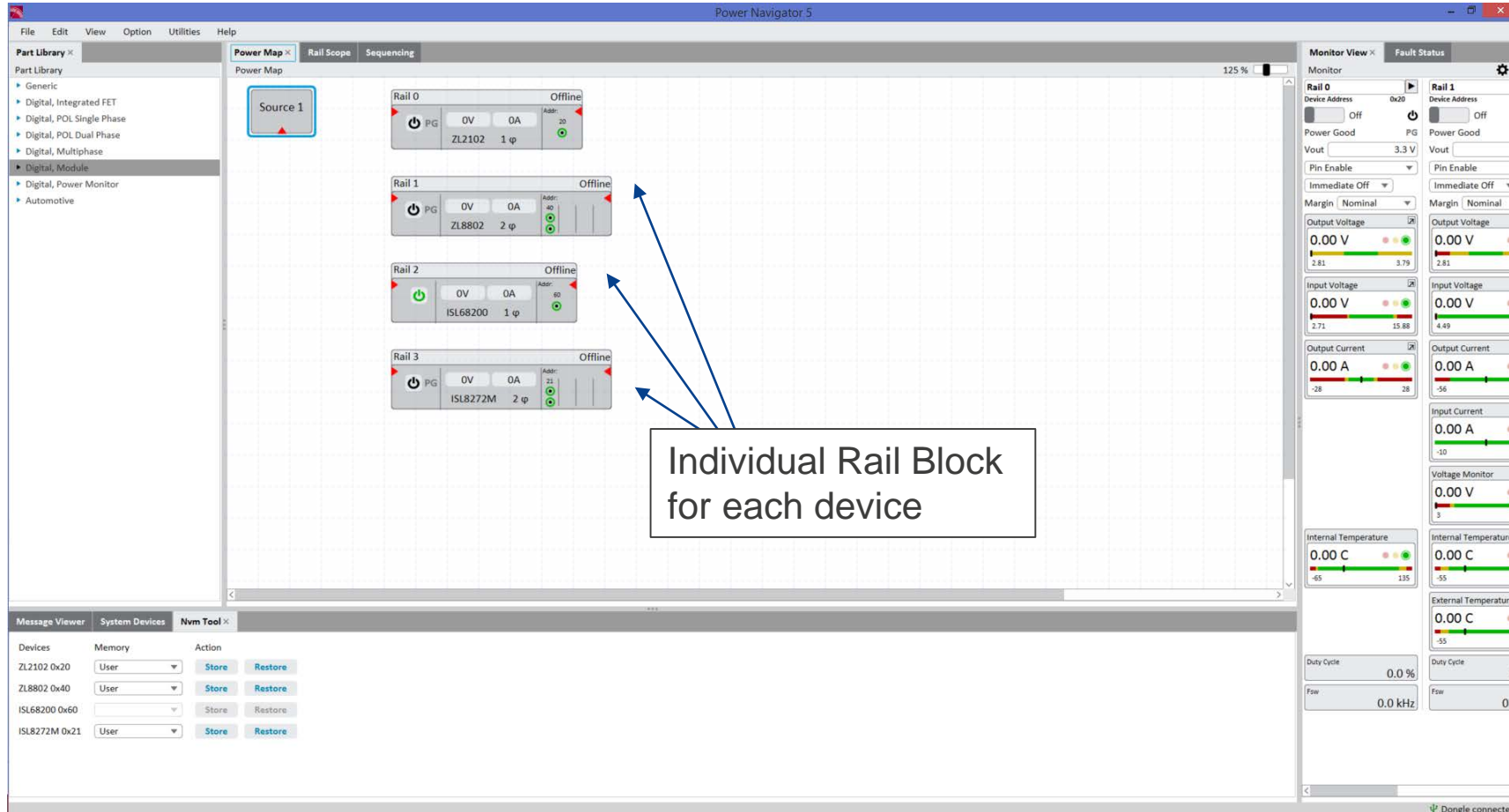

Multiple parts can be added to PowerMap, representing system level view.

PowerMap RailBlock Overview

Example ZL8802 RailBlock (2-PH operation):

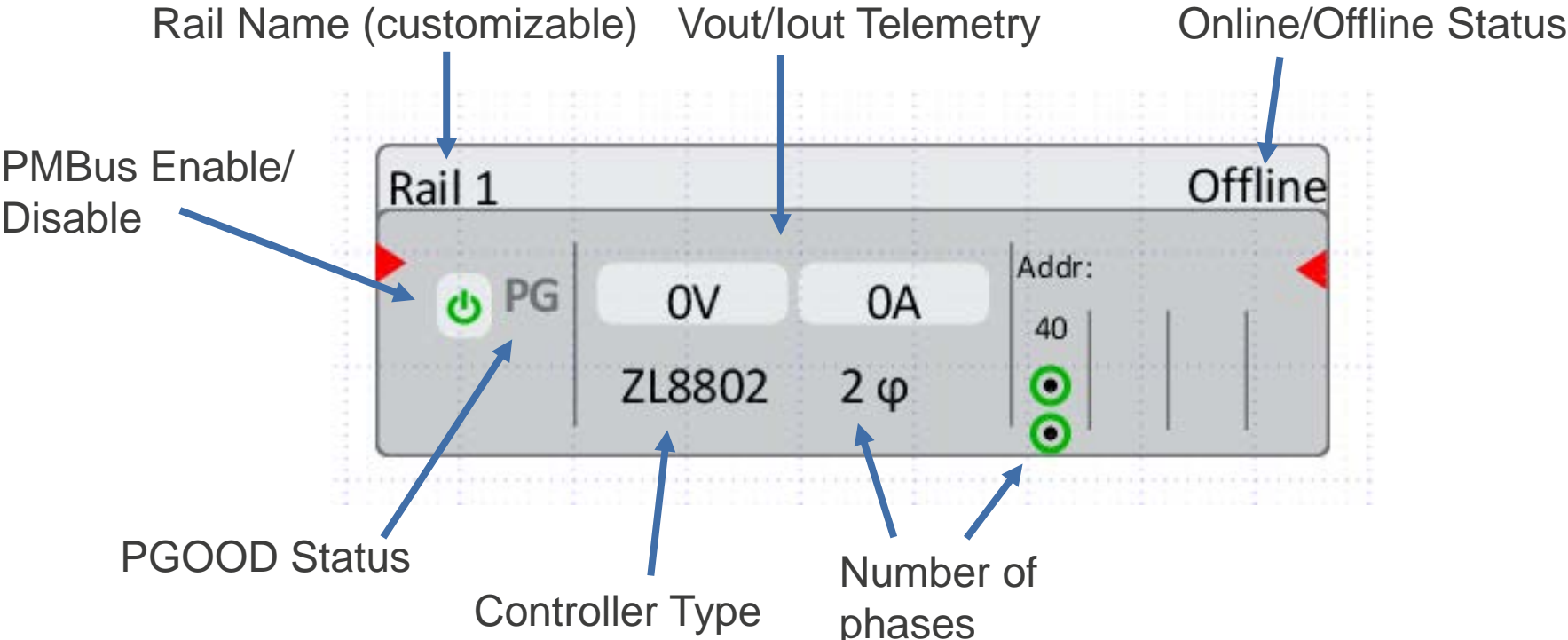

PowerMap RailBlock Overview

Example ZL8802 RailBlock (2-CH operation):

Drag and drop interface for configuration of a rail from 2-phase to dual output.

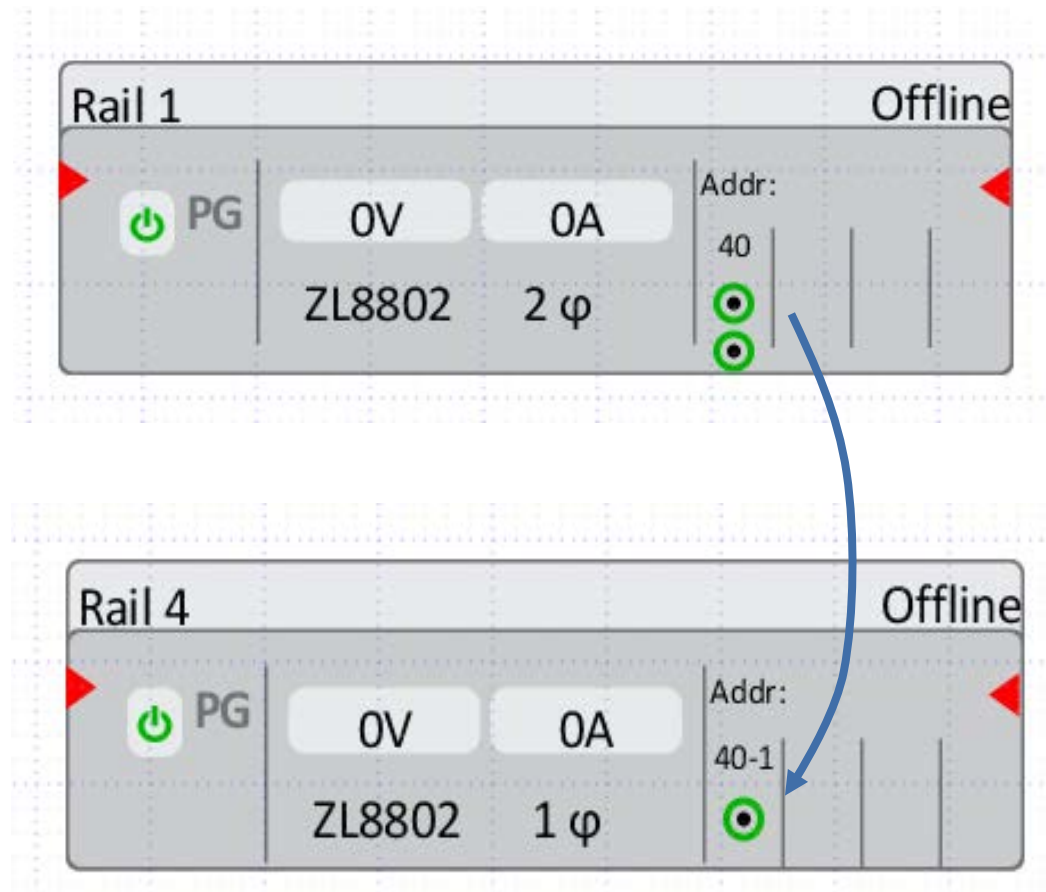

Drag "Phase Dot" to change from 2-phase to 2-Channel operation

PowerMap RailBlock Overview

Example ISL68200 RailBlock:

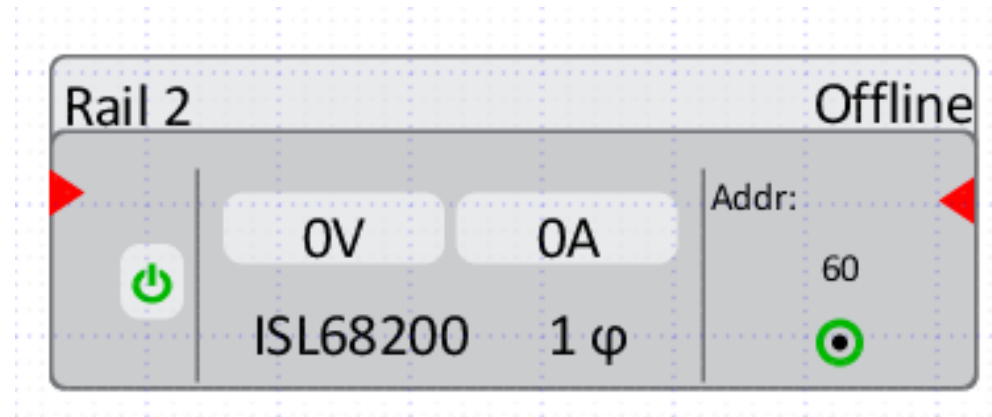

- Controllers which do not support current share will only have one “slot”.
- In this case, we have a single phase ISL68200 controller at PMBus address 0x60.

PowerNavigator – System Screen

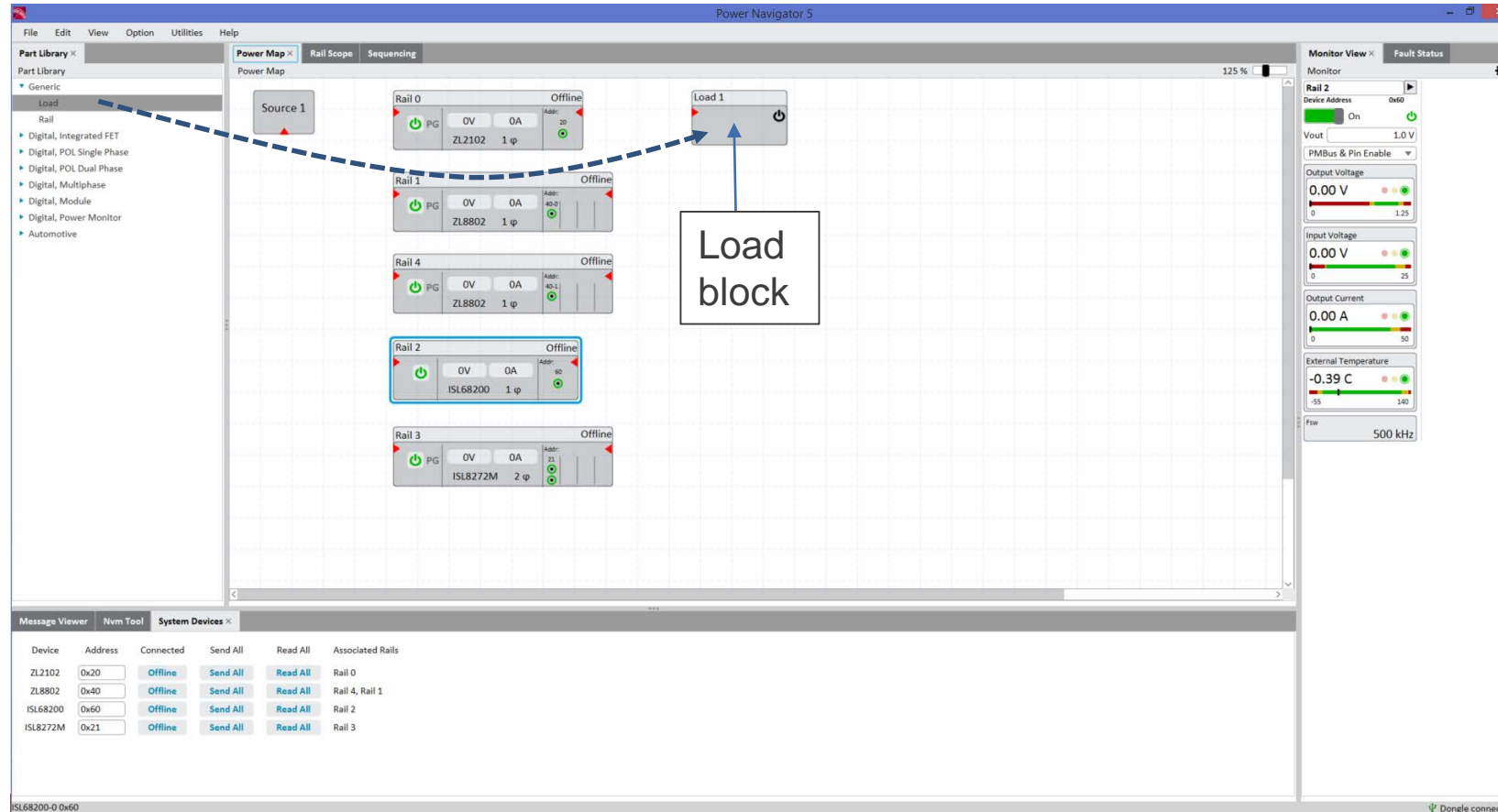

Load Blocks represent system load and can be added to the PowerMap from the Part Library. Double Click to add additional inputs.

Multi-Input Load Boxes

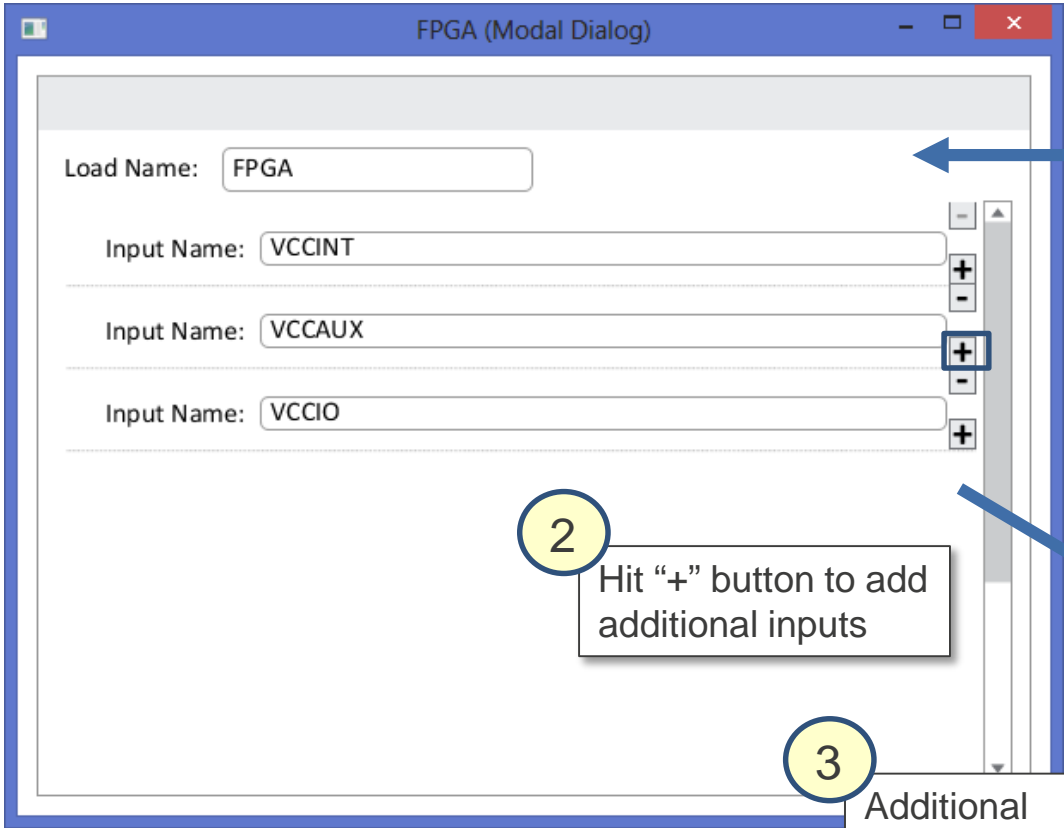

1 Double Click Load to bring up Load Inspector dialog box

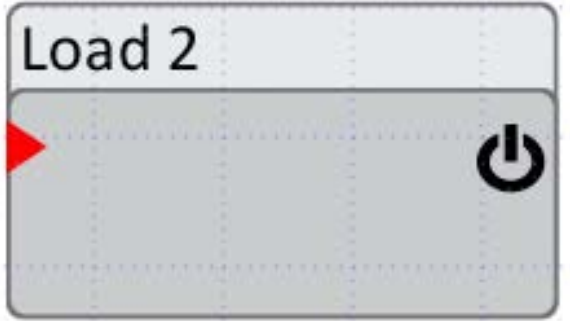

2 Hit "+" button to add additional inputs

3 Additional inputs are now added to load box

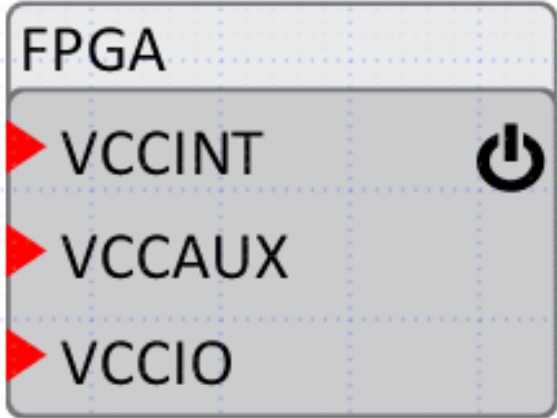

PowerNavigator 5.4 – System Screen

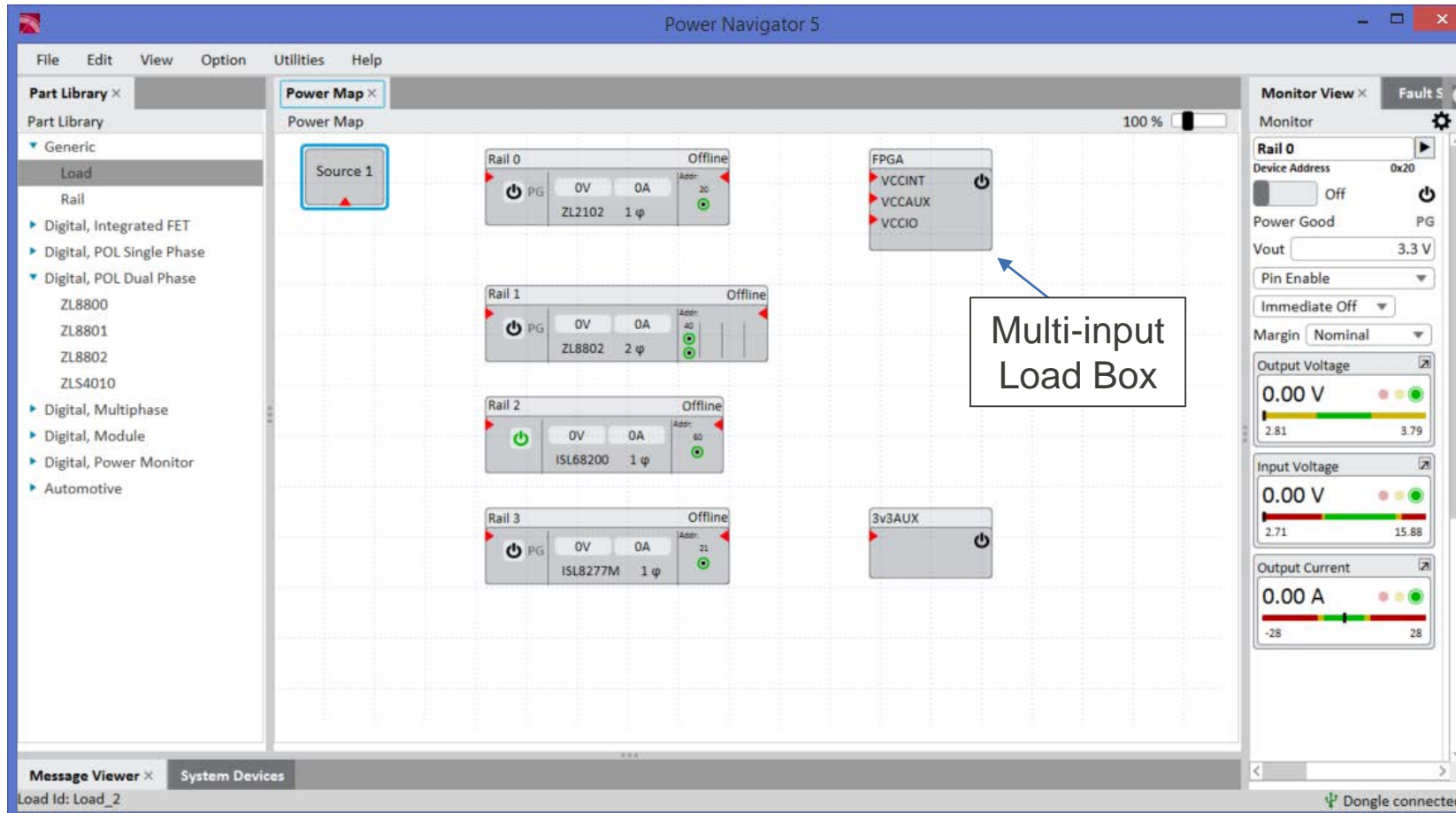

After configuring system, all sources, rails and loads can be wired together.

PowerNavigator 5.4 – System Screen

The screenshot displays the PowerNavigator 5.4 software interface. The main window is titled "Power Navigator 5" and contains a "Power Map" view. On the left, a "Part Library" pane lists various components under "Generic", "Load", and "Rail" categories. The "Power Map" area shows a central "Source 1" block connected to "Rail 0" (ZL2102, 1 φ) via a red line. Other rails shown include Rail 1 (ZL8802, 2 φ), Rail 2 (ISL68200, 1 φ), and Rail 3 (ISL8277M, 1 φ). A "3v3AUX" block is also present. A callout box with the text "Source to Rail Wiring" and a blue arrow points to the connection between Source 1 and Rail 0. On the right, the "Monitor View" pane shows real-time data for "Rail 0", including "Device Address" (0x20), "Power Good" (PG), "Vout" (3.3 V), "Output Voltage" (0.00 V, range 2.81-3.79), "Input Voltage" (0.00 V, range 2.71-15.88), "Output Current" (0.00 A, range -28-28), and "Internal Temperature" (0.00 C, range -65-135). The bottom status bar shows "Message Viewer" and "System Devices" with "ZL2102-0 0x20" selected, and a "Dongle connected" indicator.

PowerNavigator 5.4 – System Screen

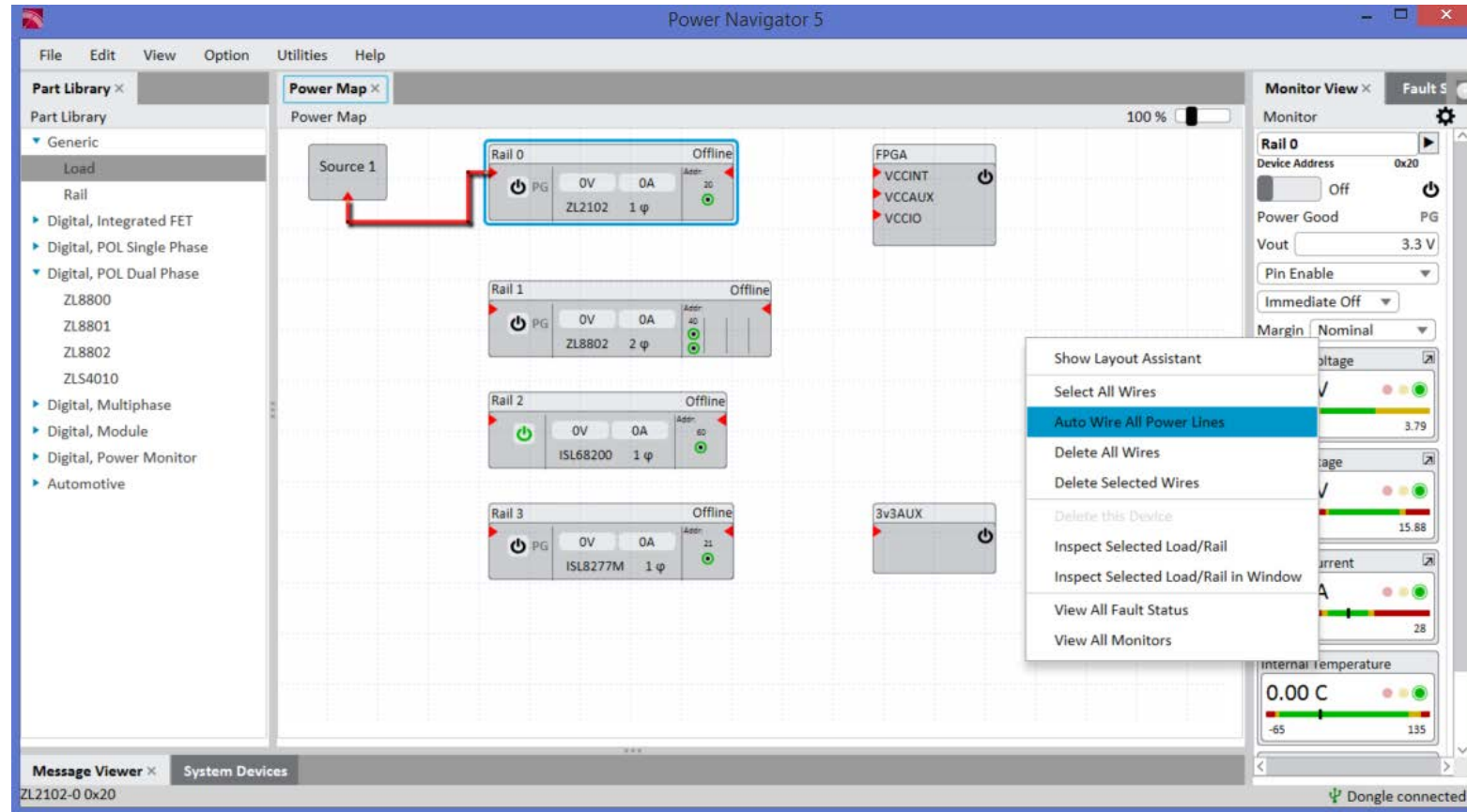

Right-click on PowerMap to bring up contextual menu.
Select “Auto Wire All Power Lines” to auto wire PowerMap.

PowerNavigator 5.4 – System Screen

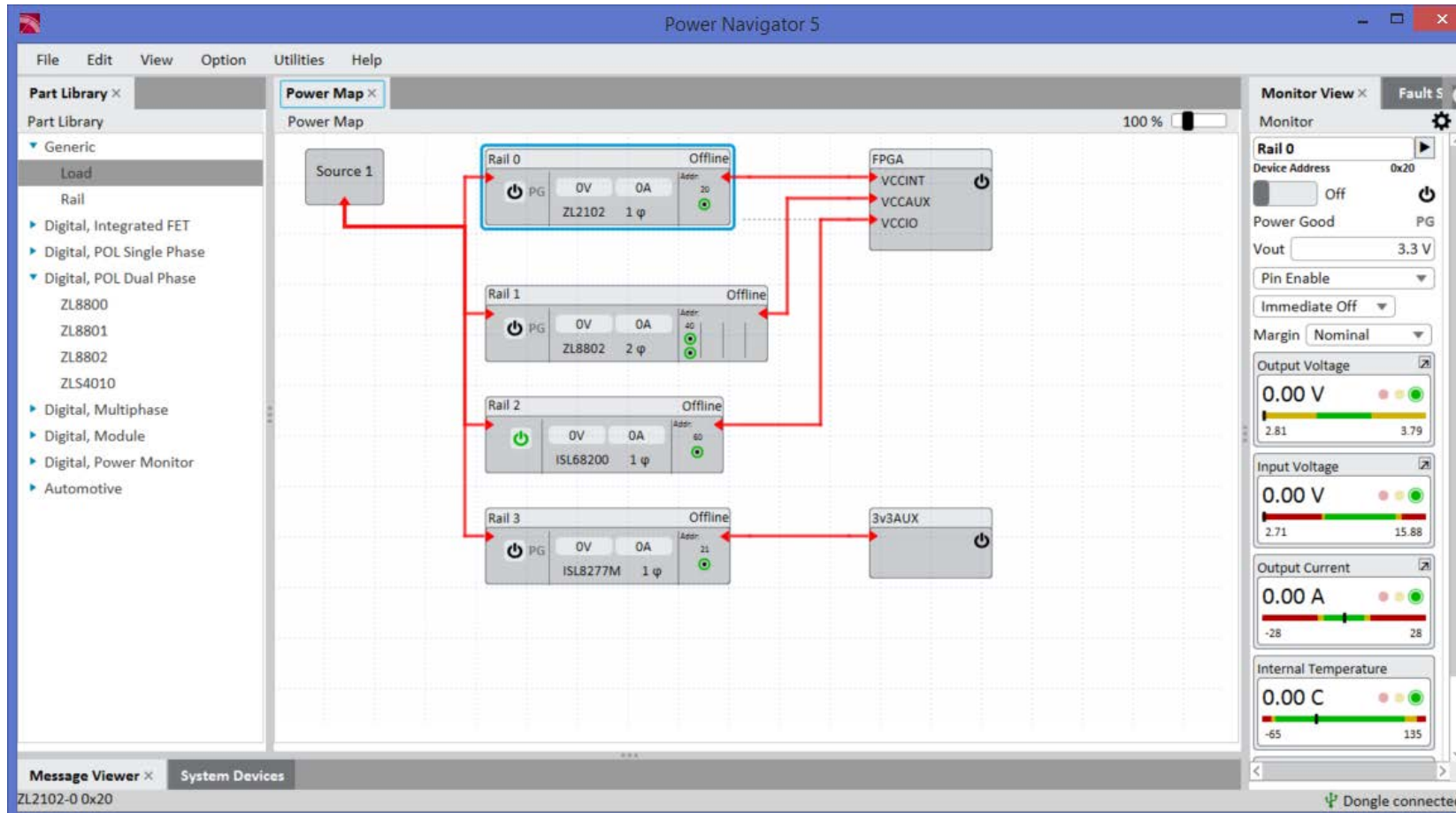

Fully wired PowerMap with multi-input loads.

PowerNavigator 5.4 – System Screen

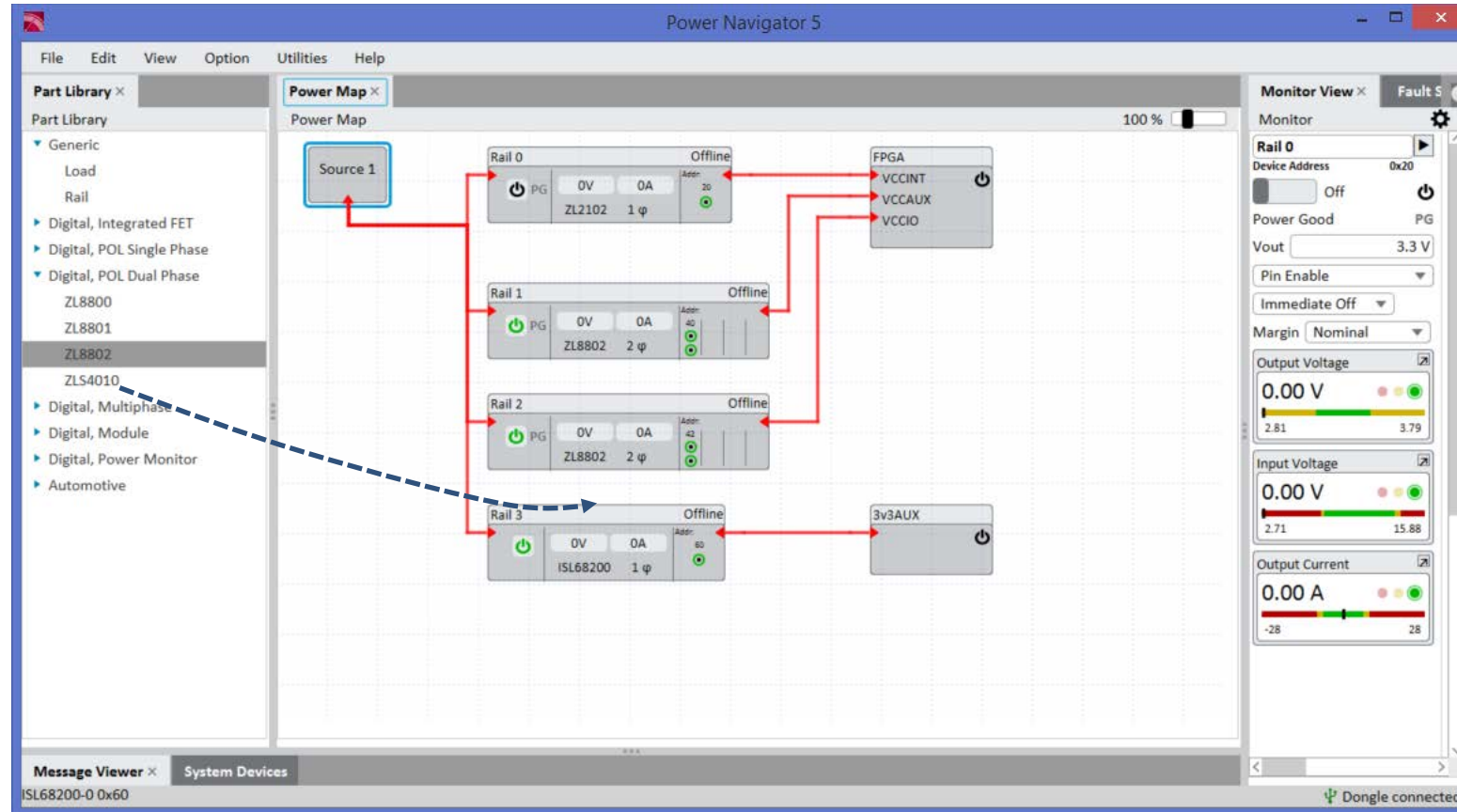

To implement a current sharing rail, drag a part from the part library onto an open RailBlock “slot”.

PowerMap RailBlock Overview

Example ZL8802 RailBlock (4-PH operation):

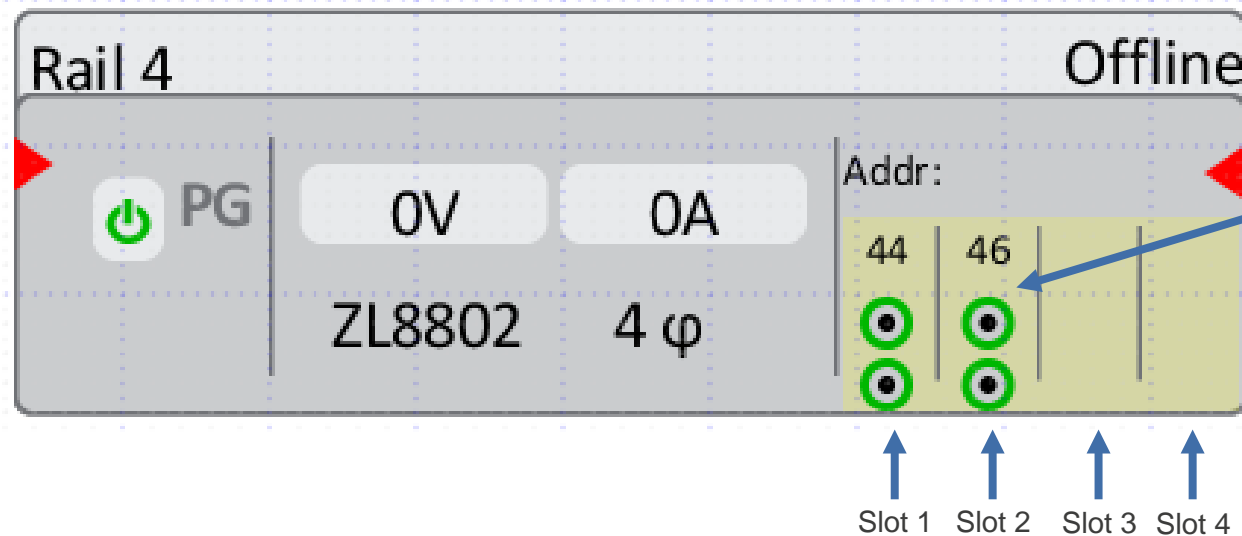

- The ZL8802 allows for 2-PH, 4-PH, 6-PH or 8-PH operation via current share.
- Each “slot” in the RailBlock represents shows how many controllers can be paralleled in a current share group.
- To create a current share group, a controller can be dragged from the part library into a “slot”, creating a current share rail.
- In this case, we have a 4-phase design, with two ZL8802 controllers – one at PMBus address 0x44 and another at 0x46.

PowerNavigator 5.4 – System Screen

The screenshot displays the PowerNavigator 5.4 software interface. The main window is titled "Power Navigator 5" and contains a "Power Map" view. On the left, a "Part Library" pane lists various power components, with "ZL8802" selected under "Digital, POL Dual Phase". The central "Power Map" shows a "Source 1" connected to four rails: Rail 0 (ZL2102, 1 φ), Rail 1 (ZL8802, 2 φ), Rail 2 (ZL8802, 4 φ), and Rail 3 (ISL68200, 1 φ). Red arrows indicate power flow from the source to the rails and then to various loads: an FPGA (VCCINT, VCCAUX, VCCIO) connected to Rail 0, a 3v3AUX load connected to Rail 3, and a callout box labeled "ZL8802 4PH Current Share" pointing to Rail 2. The right side of the interface features a "Monitor View" for "Rail 0", showing a "Monitor" section with a "Device Address" of 0x20, a "Power Good" signal (PG), and a "Vout" of 3.3 V. Below this are three status indicators: "Output Voltage" (0.00 V, range 2.81-3.79), "Input Voltage" (0.00 V, range 2.71-15.88), and "Output Current" (0.00 A, range -28-28). The bottom status bar shows "Message Viewer" and "System Devices" with addresses for ZL8802-1.

Monitoring View

The screenshot displays a vertical stack of monitoring panels for a device rail. The panels include:

- Monitor Header:** Includes a gear icon for configuration options and the rail name "0.8V AUX".
- Device Information:** Shows "Device Address 0x46", a power status indicator (On), and a "Power Good" indicator (PG).
- Control Panel:** Features a "Vout" adjustment slider set to 0.8 V, a "Pin Enable" dropdown, a "Soft Off" dropdown, and a "Margin" dropdown set to "Nominal".
- Output Voltage:** A gauge showing 0.80 V with a range from 0.64 to 0.96.
- Output Current:** A gauge showing -0.86 A with a range from -120.15 to 288.
- Input Current:** A gauge showing -0.36 A with a range from -10 to 10.
- Power Stage Temp:** A gauge showing 31.75 C with a range from -45 to 125.
- Internal Temperature:** A gauge showing 30.06 C with a range from -55 to 135.
- Duty Cycle:** A field showing 6.59 %.
- Fsw:** A field showing 533.0 kHz.

Callout boxes provide the following descriptions:

- View configuration options:** Points to the gear icon in the Monitor header.
- Device rail name:** Points to the "0.8V AUX" text.
- PGOOD indicator:** Points to the "PG" indicator.
- Adjustment on output voltage:** Points to the "Vout" slider.
- Monitoring readouts for Vout, Iout, Iin:** Points to the Output Voltage, Output Current, and Input Current gauges.
- Temperature monitors for both internal (controller junction) and external (power stage FETs):** Points to the Power Stage Temp and Internal Temperature gauges.
- Duty cycle and switching frequency:** Points to the Duty Cycle and Fsw fields.

Readouts

Analog sliding meter with color indicators. Green is within normal limits, yellow in PMBus warning limits, red for exceeding OVP/UVF settings.

Clicking this button will open the window below allowing adjustment of limits

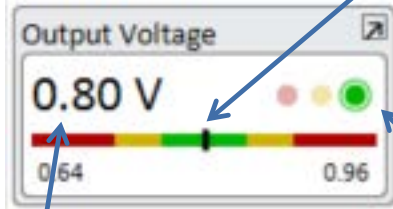

Operation and fault lights

Digital readout of output voltage

The 'Vout Margins & Limits' window contains the following configuration options:

Parameter	Value	Percentage
Vout Max	1.15 V	Set to Defaults
Vout OV Fault Limit	0.884 V	10.5 %
Vout Margin High	0.84 V	5.0 %
Vout Margin Low	0.76 V	-5.0 %
Power Good Threshold	0.72 V	-10.0 %
Vout UV Fault Limit	0.716 V	-10.5 %
Margin/Limits Track Vout	<input checked="" type="checkbox"/>	
Display Limit High	0.96 V	20.0 %
Display Limit Low	0.64 V	-20.0 %
Display Limits Track Vout	<input checked="" type="checkbox"/>	
Vout Command	0.8 V	

The window also includes a smaller version of the 'Output Voltage' readout window shown in the previous figure.

Connecting to Hardware

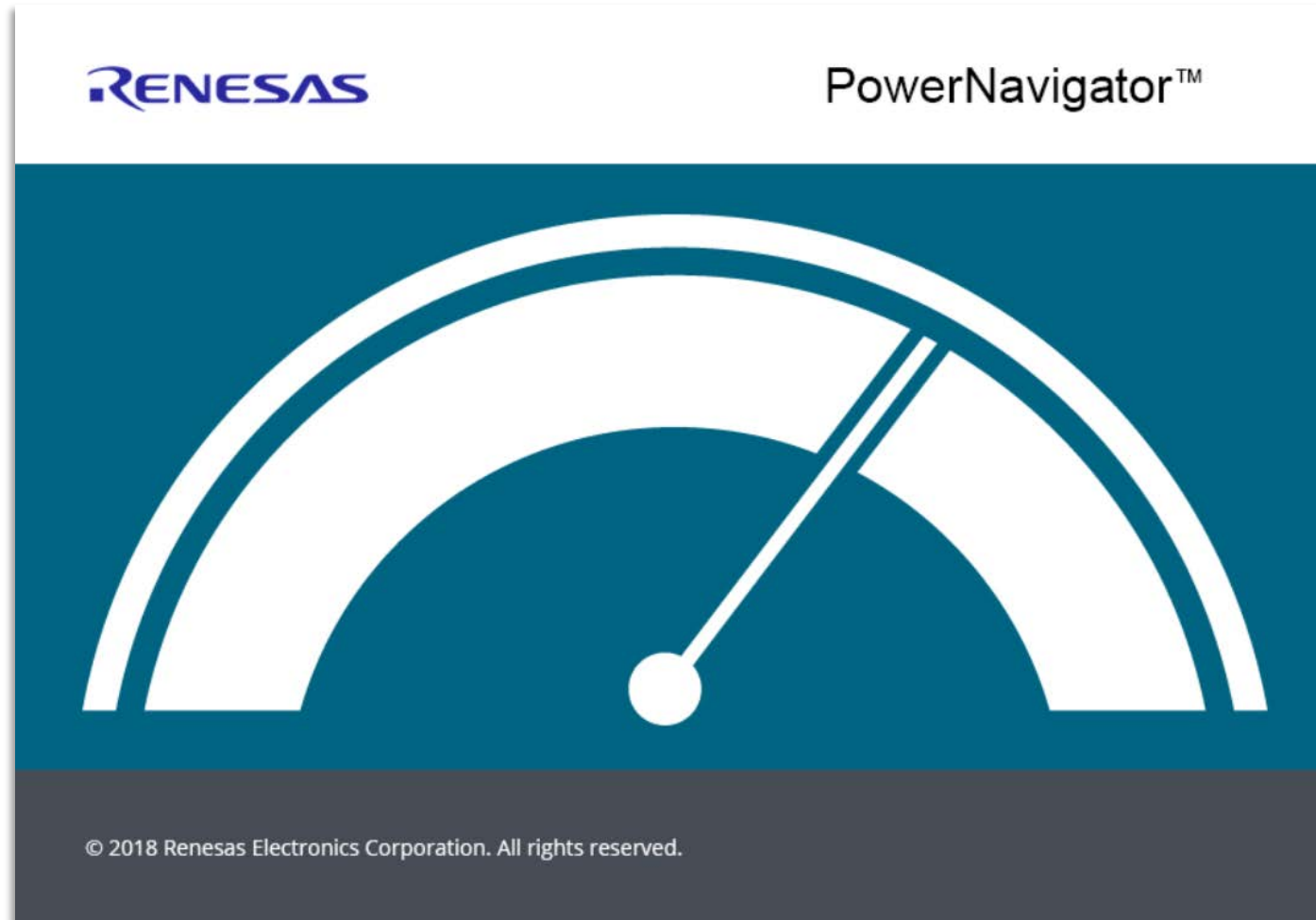

Connect to Hardware . . .

- To connect to hardware, a USB to PMBus adapter (ZLUSBEVAL3Z, included with all demo kits) is required.
- STEP 1: Connect USB cable from PC to USB adapter
- STEP 2: Connect USB to PMBus adapter to demo board hardware
- STEP 3: Power demo board
- STEP 4: Launch PowerNavigator software

Connect to Hardware . . .

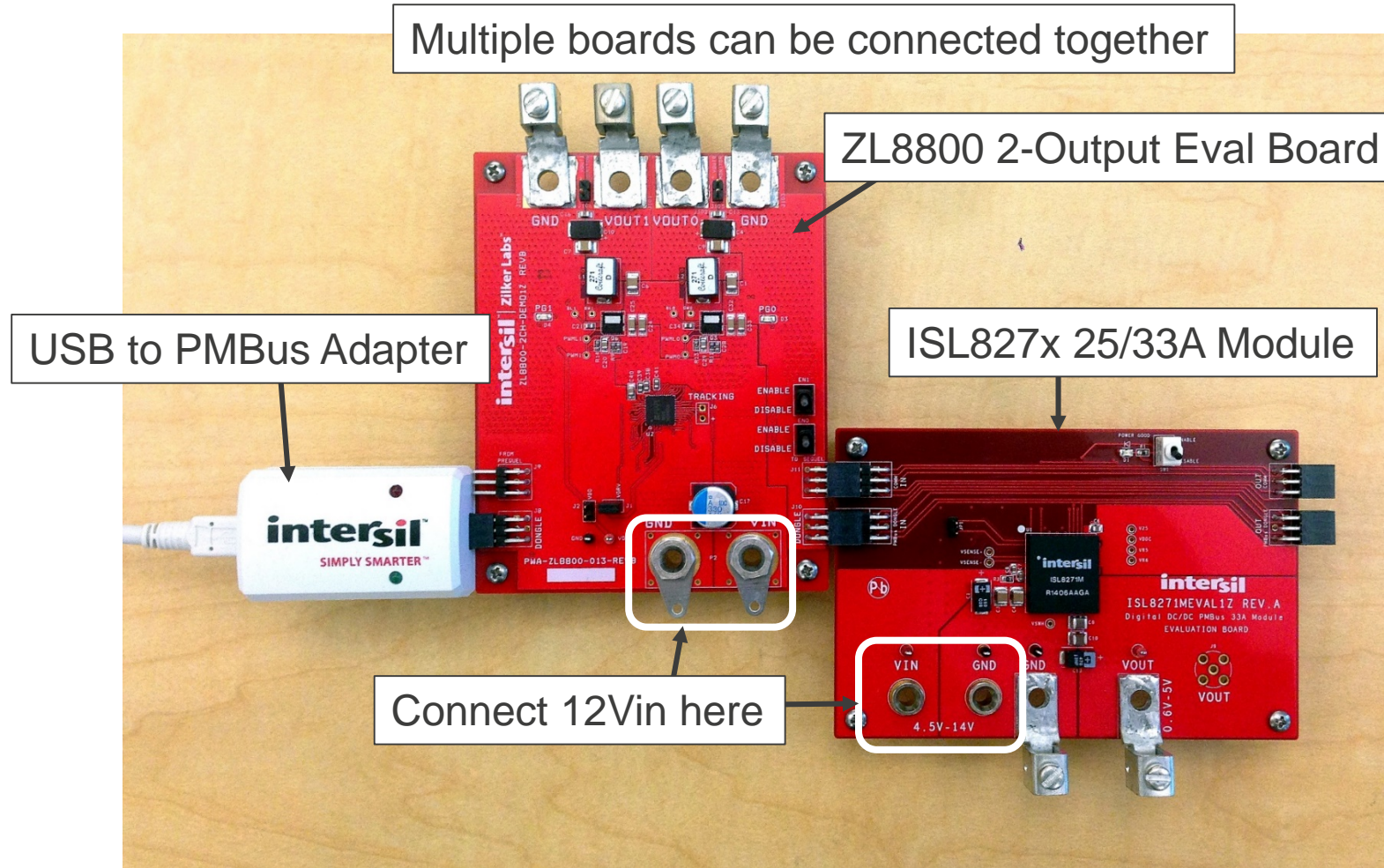

PowerNavigator Launch Screen

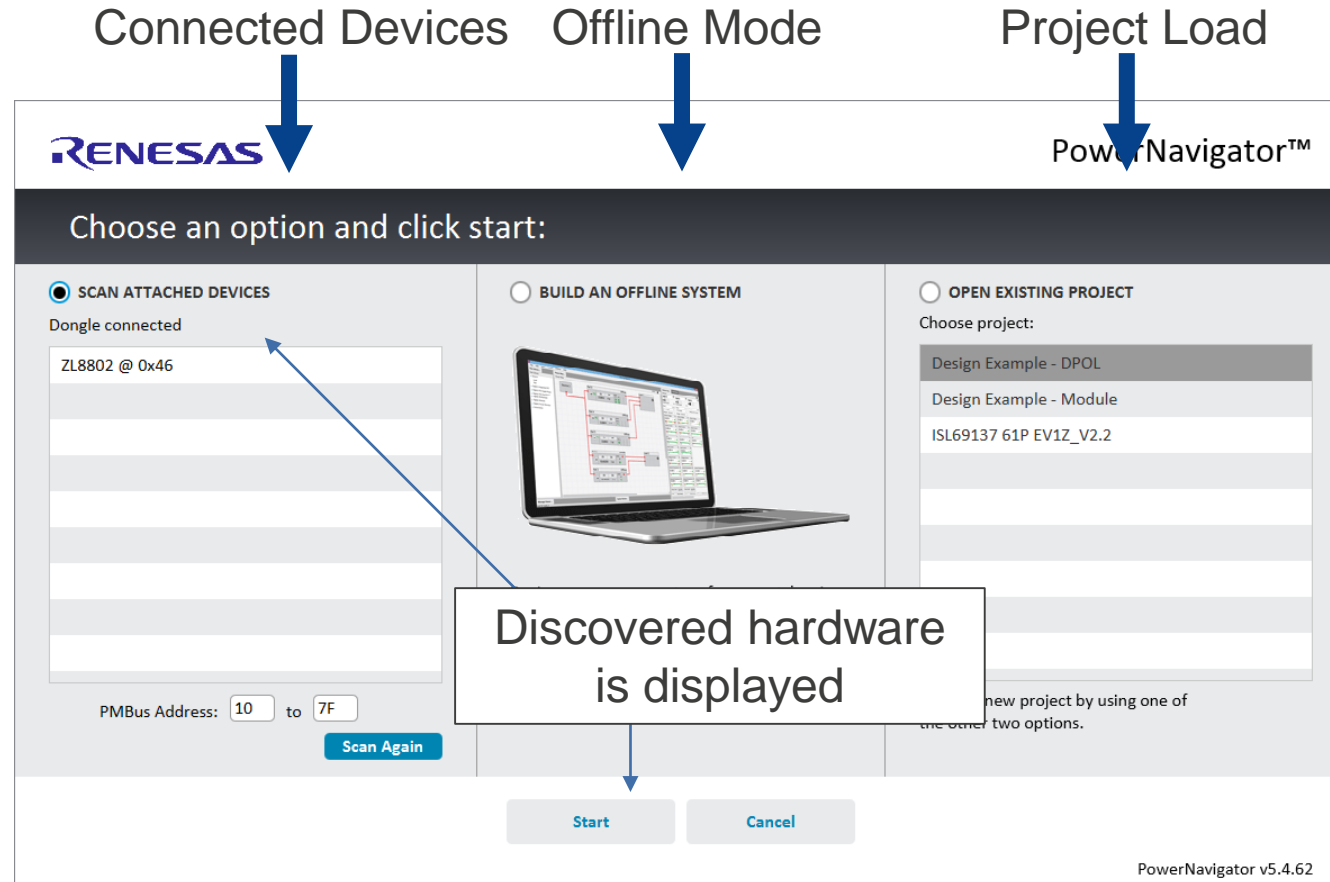

All discovered hardware is displayed in the “Scan Attached Devices” window.
The PMBus scan range can be adjust – default range is 0x10 to 0x7F.

PowerNavigator 5.4 – Connect to HW

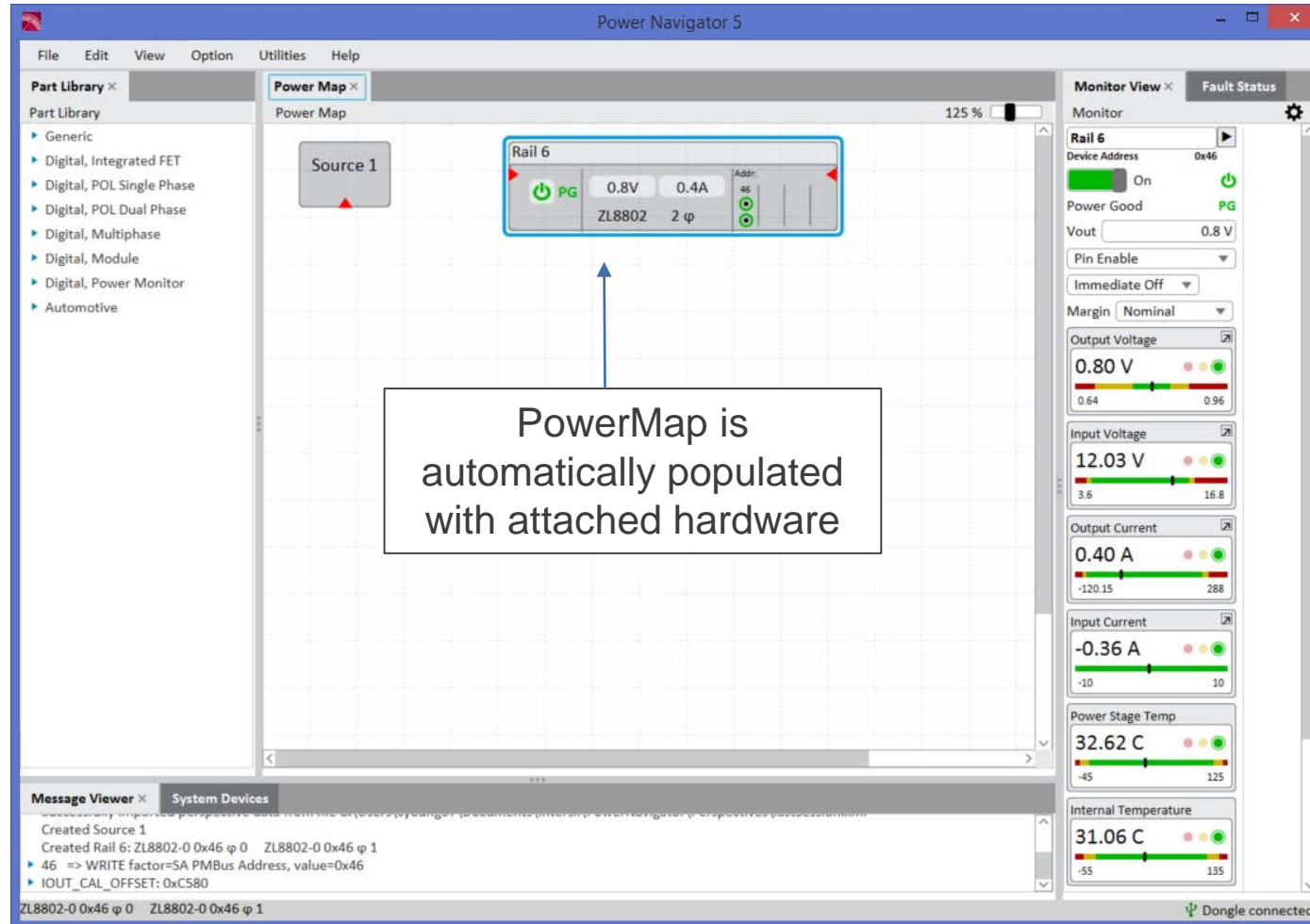

PowerNavigator 5.4 – Connect to HW

The screenshot displays the PowerNavigator 5.4 software interface. The main window is titled "Power Navigator 5" and contains several panes:

- Part Library:** A tree view on the left showing categories like "Generic", "Rail", "Load", "Digital, Integrated FET", "Digital, POL Single Phase", "Digital, POL Dual Phase", "Digital, Multiphase", "Digital, Module", "Digital, Power Monitor", and "Automotive".
- Power Map:** A central diagram showing a "Source 1" block connected to a "Rail 6" block, which is then connected to a "Load 1" block. The "Rail 6" block is a ZL8802 2-phase converter with a 0.8V output and 0.4A current. A blue arrow points to the Rail 6 block from a text box.
- Monitor View:** A panel on the right showing real-time monitoring data for "Rail 6". It includes a "Monitor" tab and a "Fault Status" tab. The "Monitor" tab shows:
 - Device Address: 0x46
 - Power Good: On (PG)
 - Vout: 0.8 V
 - Pin Enable: Immediate Off
 - Margin: Nominal
 - Output Voltage: 0.80 V (range 0.64 to 0.96)
 - Input Voltage: 12.03 V (range 3.6 to 16.8)
 - Output Current: 0.34 A (range -120.15 to 288)
 - Input Current: -0.33 A (range -10 to 10)
 - Power Stage Temp: 33.56 C (range -45 to 125)
 - Internal Temperature: 31.56 C (range -55 to 135)
- Message Viewer:** A panel at the bottom showing system messages, including "46 => WRITE factor=5A PMBus Address, value=0x46" and "IOUT_CAL_OFFSET: 0xC580".

A text box in the center of the Power Map diagram contains the following text:

System load can be added to PowerMap. RailBlocks can be wired to input source and load.

PowerNavigator 5.4 – Project Save

The screenshot shows the PowerNavigator 5.4 interface. The 'File' menu is open, with 'Save' (Ctrl+S) highlighted. A 'Save Project' dialog box is displayed in the foreground, with 'Project Name' set to 'new'. The background shows a Power Map diagram with 'Source 1', 'Rail 6' (0.8V, 0.4A), and 'Load 1'. A 'Monitor View' panel on the right shows various parameters like 'Rail 6' (0.8V), 'Output Voltage' (1.80V), 'Output Current' (0.38A), and 'Temperature' (4.44C).

To save a project, go to File -> Save

Saving a project will save any device configuration files, PowerMap setup, and PowerNavigator perspective settings.

PowerNavigator – Rail Inspector

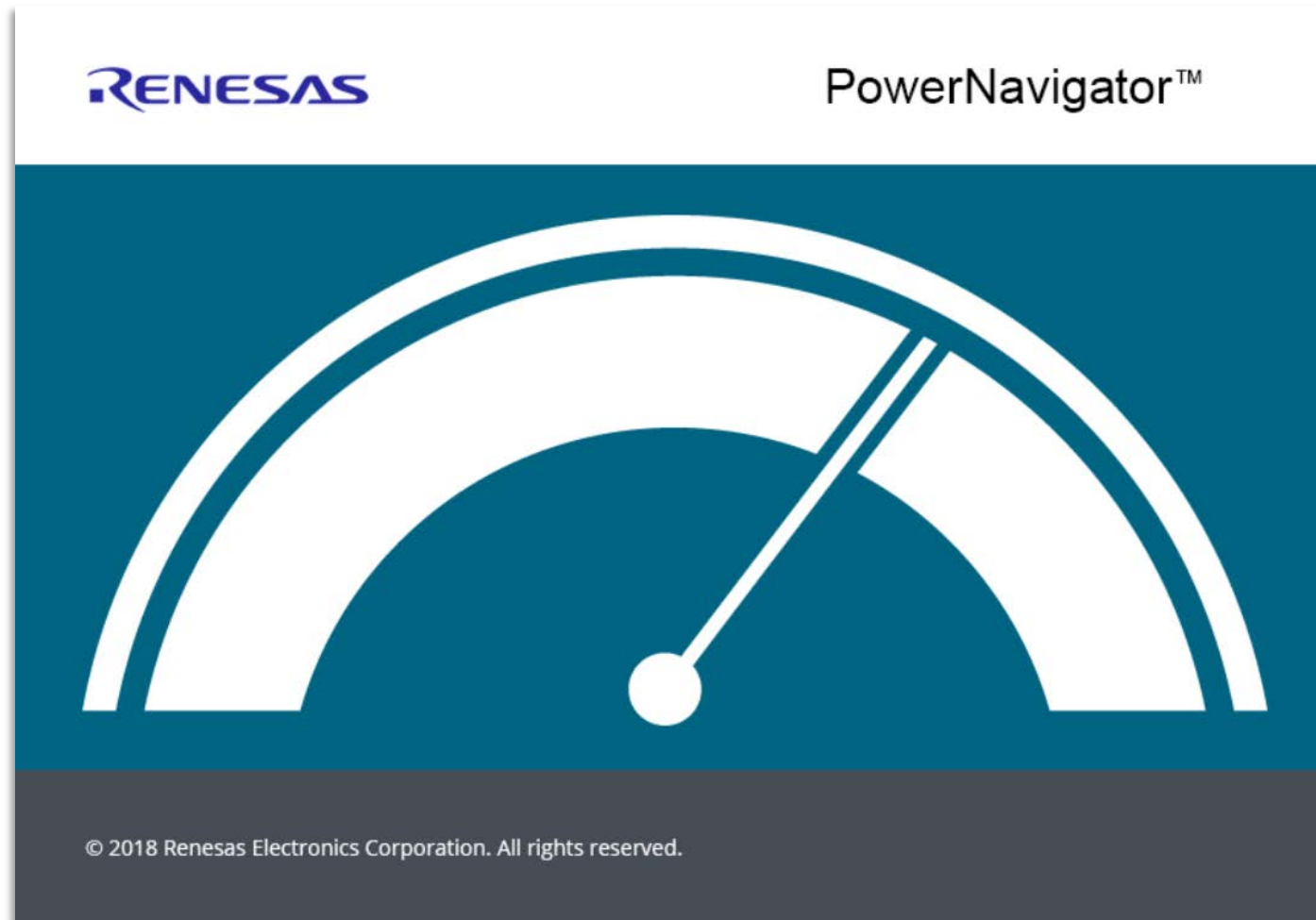

PowerNavigator 5.4 – Rail Inspector

- Rail Inspector tool eases device configuration
 - Double click on RailBlocks to bring up individual Rail Inspector for each device.
 - Each device in PowerNavigator can have its own, customized Rail Inspector.
- Rail Inspector tool can be used to:
 - Quickly see rail summary, including PMBus addresses, controller type, PMBus status, device options, fault status, etc.
 - Save/Load Configuration Files
 - Configure device using command tool
- Allows for future expandability
 - Future releases of PowerNavigator will expand Rail Inspector features

PowerNavigator 5.4 – Rail inspector

1 Double Click RailBlock to bring up Load Inspector window

2 Rail Inspector Window will appear

The Rail Inspector window displays the following information:

- Overview**
 - Configuration
 - Design Requirements
 - Component Selection
 - Efficiency
 - Current Sense
 - Pinstrap Configuration
 - Design Verification
 - Schematic
 - Telemetry
 - Monitor
 - Fault
 - Phase Scope
 - Command Tools
 - New
- Rail Information**
 - Rail Name: Rail 0
 - Devices: ISL68200 (Address: 0x60)
 - Config File: Load
 - Page: Save
- Voltage & Current**
 - Input Voltage: 12.12 V
 - Frequency Switch: 400 kHz
 - Output Voltage: 1.0 V
 - Load Current: 0.0 A
- Configuration Settings**
 - Programming Pin 1: 0x80
 - Programming Pin 2: 0xa0
 - Programming Pin 3: 0x08
 - Programming Pin 4: 0x00
- Rail Status**
 - Vout Status: Enabled
 - PMBus Status: Online

Example Rail Inspector – ISL68200

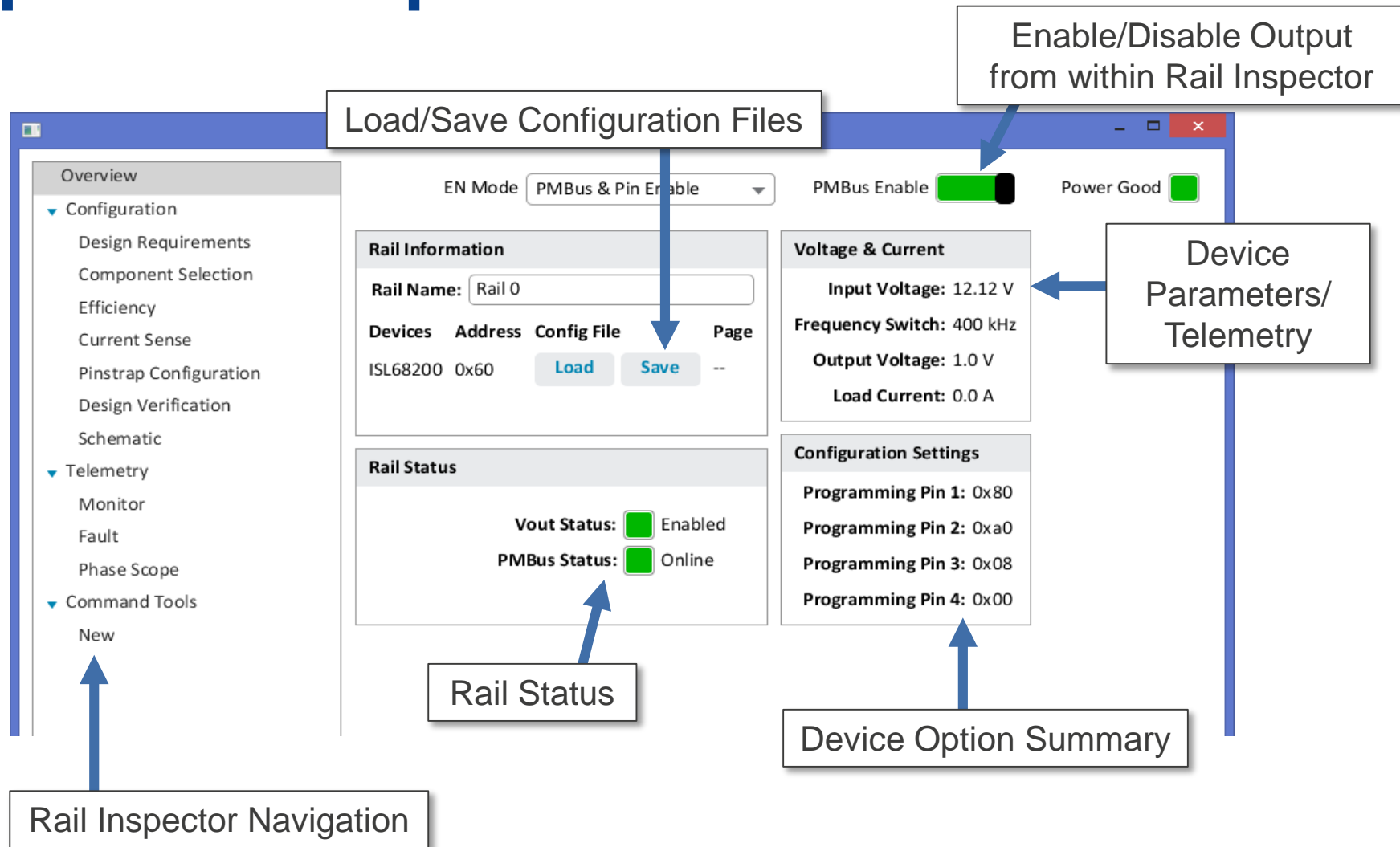

Example Rail Inspector – ISL68200

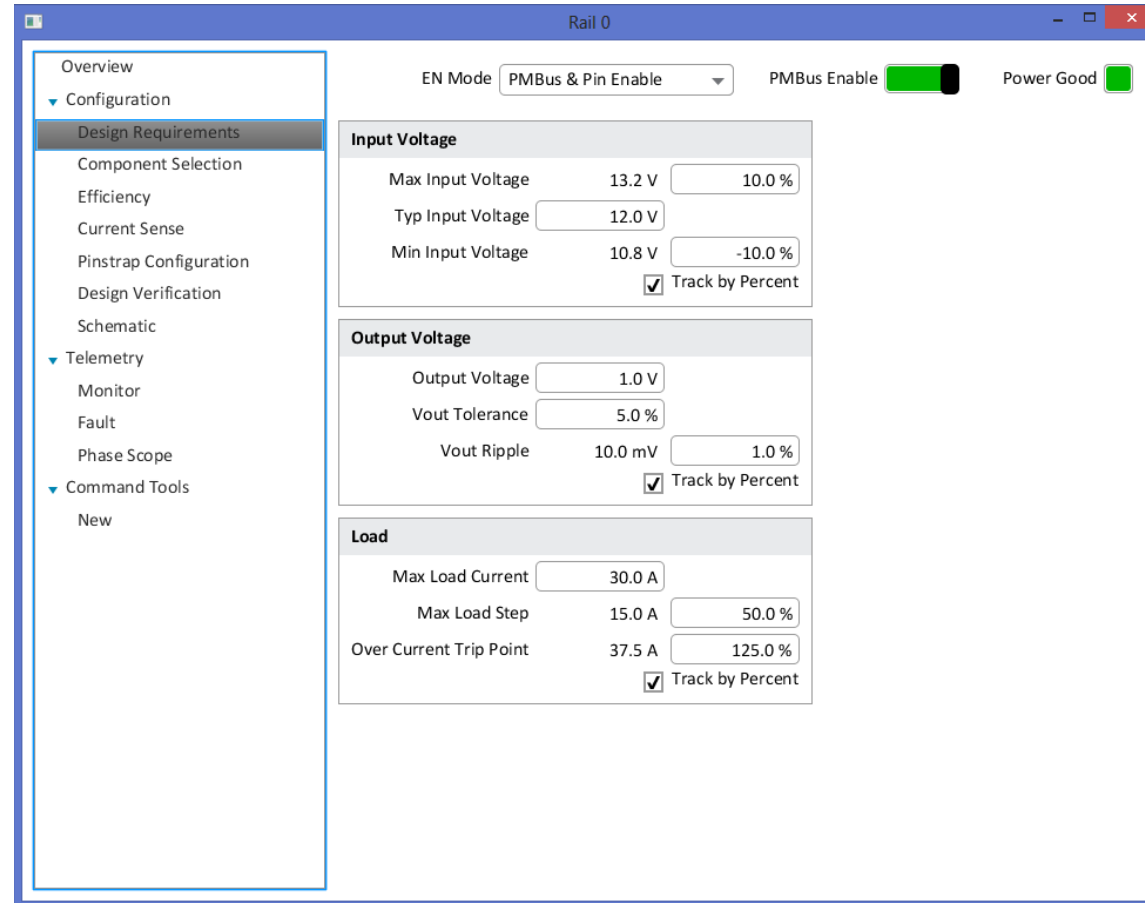

Design Requirements – Enter Vin, Vout and Iout requirements

Example Rail Inspector – ISL68200

EN Mode: PMBus & Pin Enable | PMBus Enable: ■ | Power Good: ■

Click on components in the schematic to configure them.

FSW: 400 kHz

VIN = 12.0 V

Q1: Rds(on) = 5.0 mΩ, Quantity = 1

L = 0.22 μH, DCR = 0.29 mΩ

VOUT = 1.0 V

Q2: Rds(on) = 1.2 mΩ, Quantity = 1

Qty = 4: C = 220.0 μF, ESR = 4.0 mΩ, ESL = 1.0 nH

Qty = 2: C = 47.0 μF, ESR = 4.0 mΩ, ESL = 0.6 nH

UFET

Manufacturer Part No:

Quantity:

Rds(on) at 5V:

Qg:

Coss:

Ton_Switch:

Toff_Switch:

Current		DCR Match	
Inductor Peak-Peak Ripple	10.417 A	RDCR	9.53 kΩ
Peak Current at Full Load	35.208 A	CDCR	<input type="text" value="1.0 μF"/>

Component Selection – Enter FET, Inductor and Output Cap information

Example Rail Inspector – ISL68200

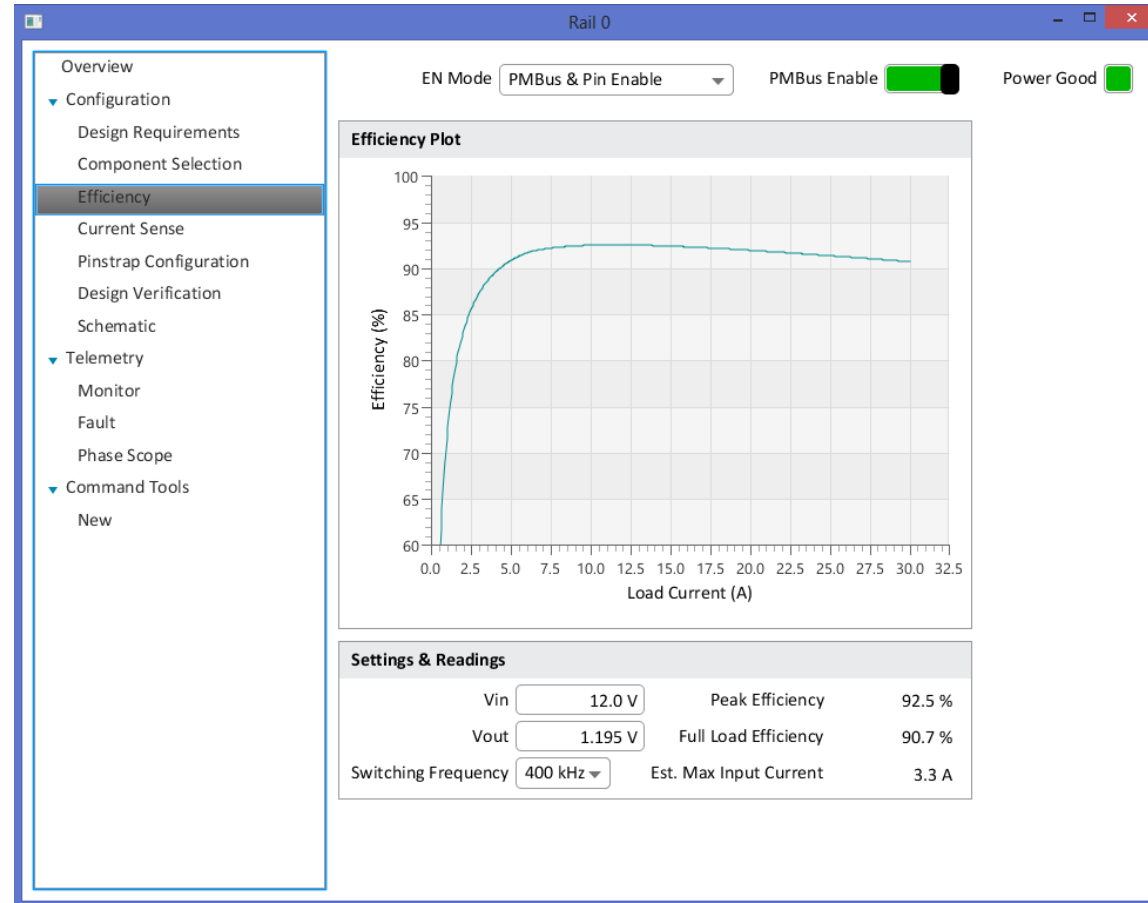

Efficiency – Real time plot of efficiency with selected components and switching frequency.

Example Rail Inspector – ISL68200

EN Mode: PMBus & Pin Enable | PMBus Enable: | Power Good:

Over Current

Desired Over Current Trip Point: 37.5 A

Current Sense Calculatons

Current sense gain resistor (Risen): 107.0 Ω

Iout gain resistor (Riout): 14.7 kΩ

Calculate OC Trip Points

Average Over Current Trip Point: 37.5 A

Peak Over Current Trip Point: 48.75 A

Current Sense Diagram

ISL68200 INTERNAL CIRCUIT

PLACE THESE IN CLOSE PROXIMITY TO ISL68200

Labels in diagram: DRIVER, V_{IN}, I_L(s), INDUCTOR, DCR, V_L, V_{OUT}, C_{OUT}, +V_C(s), OPTIONAL, R, C, RISEN, CSSEN, CSRTN, I_{SEN} = I_L * DCR / RISEN

Current Sense – Automatic calculation of current sense resistor settings based on desired OC trip point.

Example Rail Inspector – ISL68200

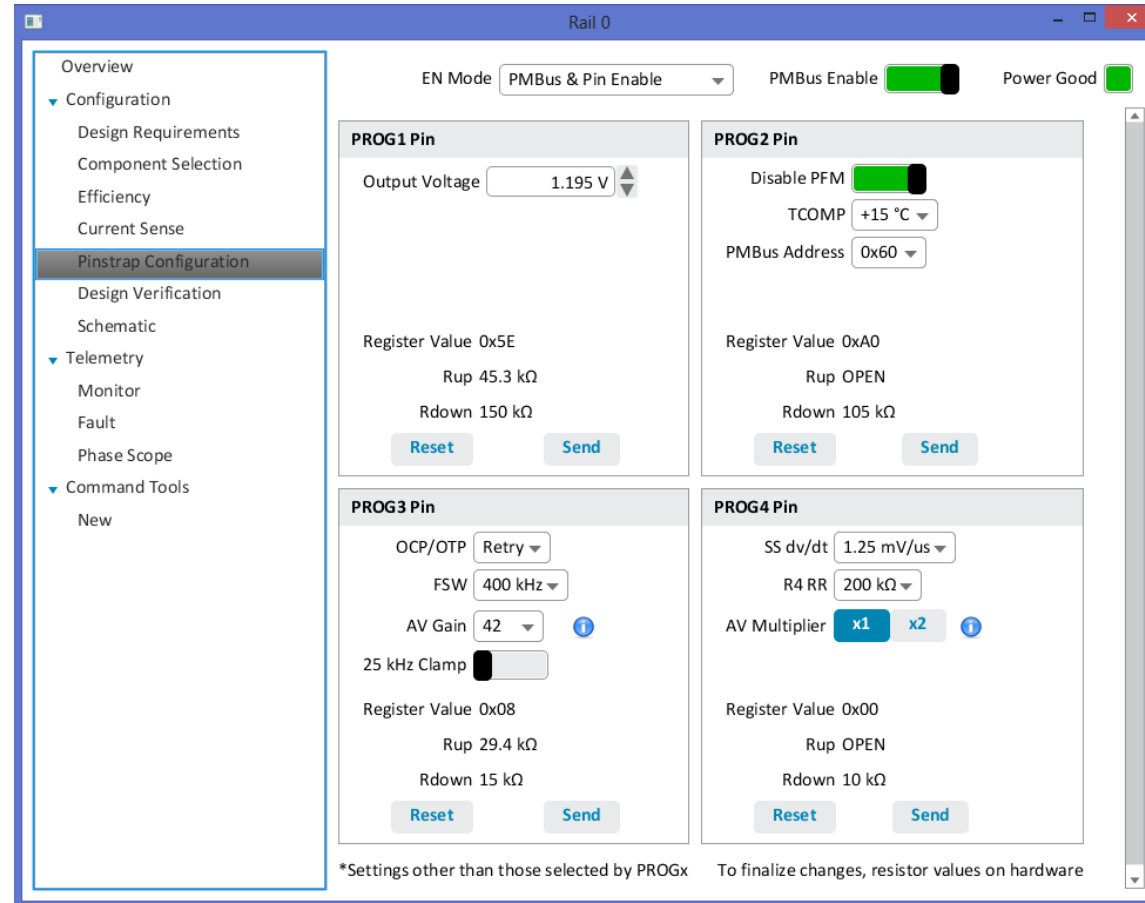

Pinstrap Configuration – Select pinstrap resistors to setup device default settings.

Example Rail Inspector – ISL68200

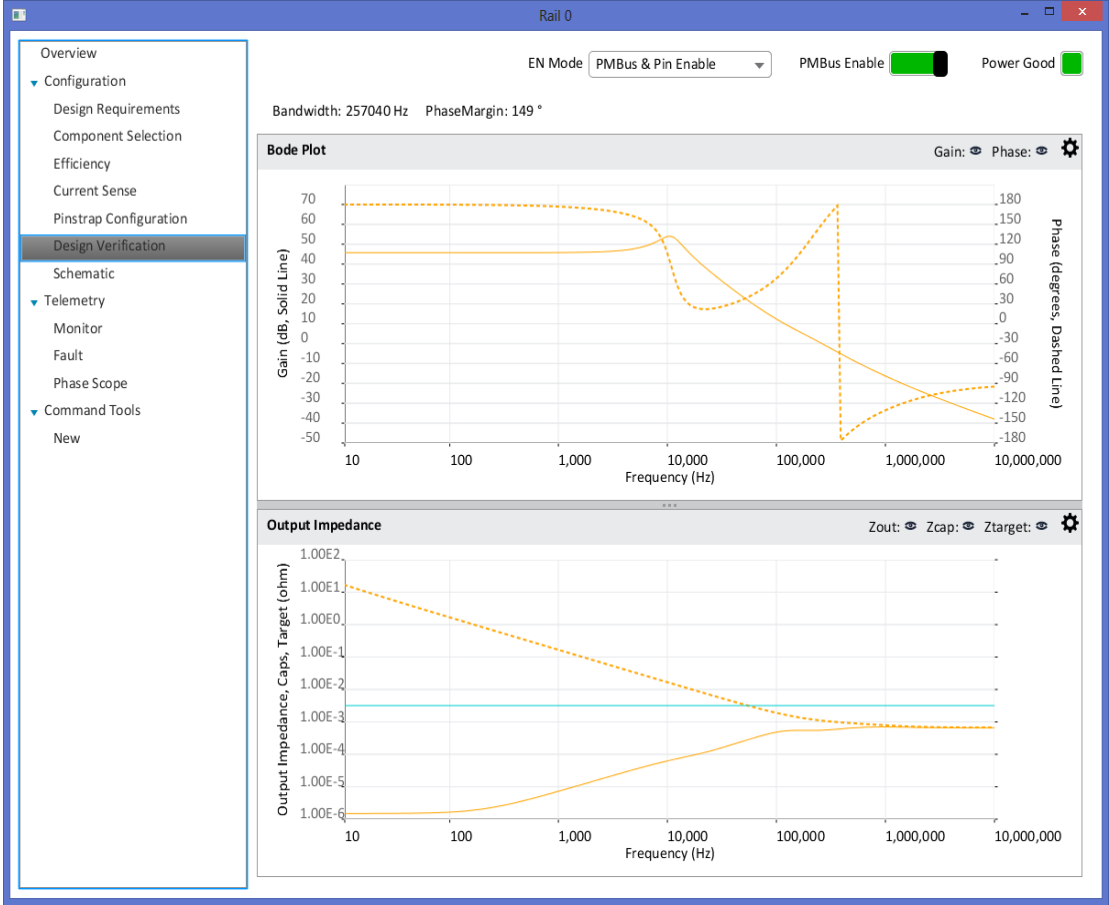

Design Verification— Bode and Output Impedance plots of design.

Example Rail Inspector – ISL68200

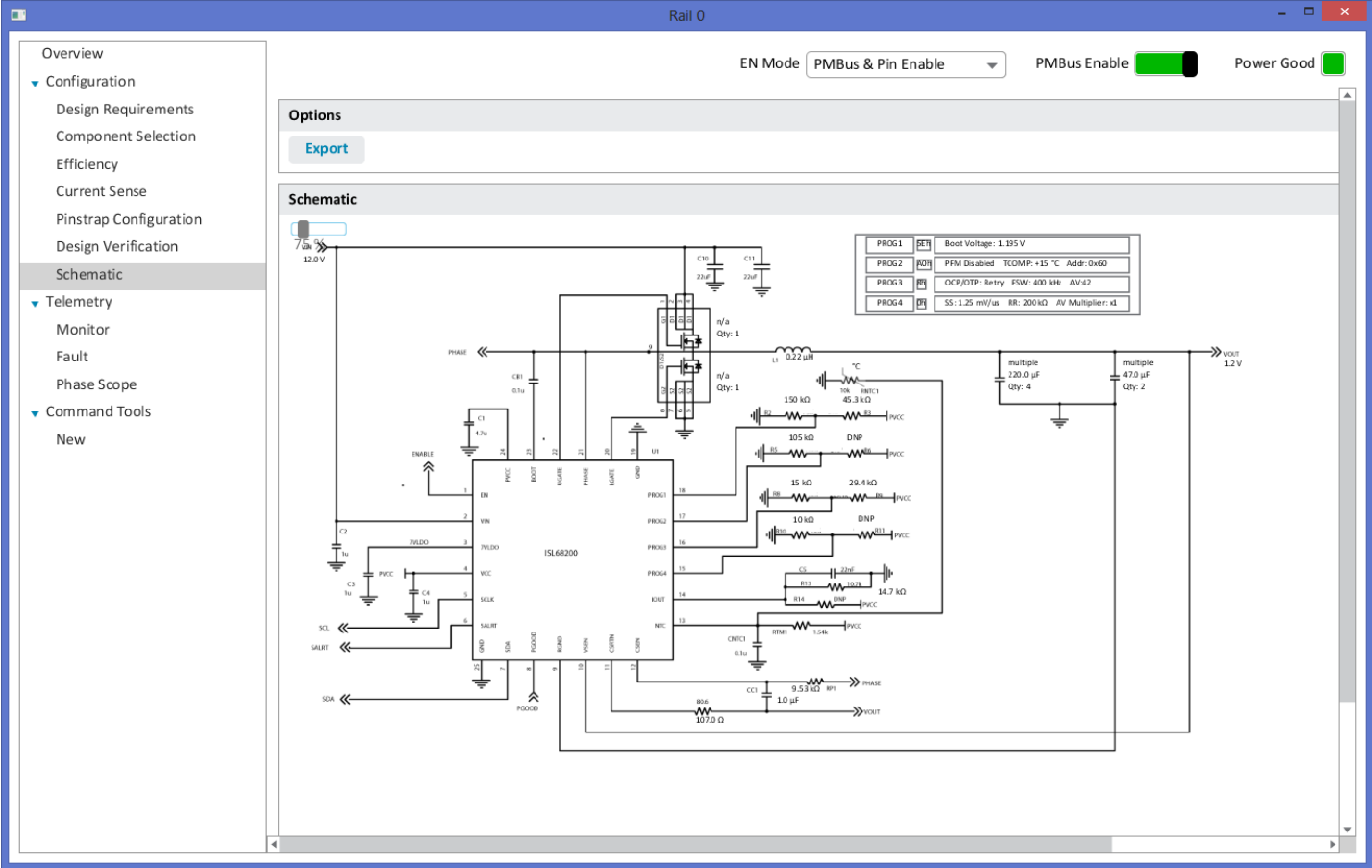

Schematic Generation – Final schematic, with customized components, generated automatically.

Example Rail Inspector – ISL68200

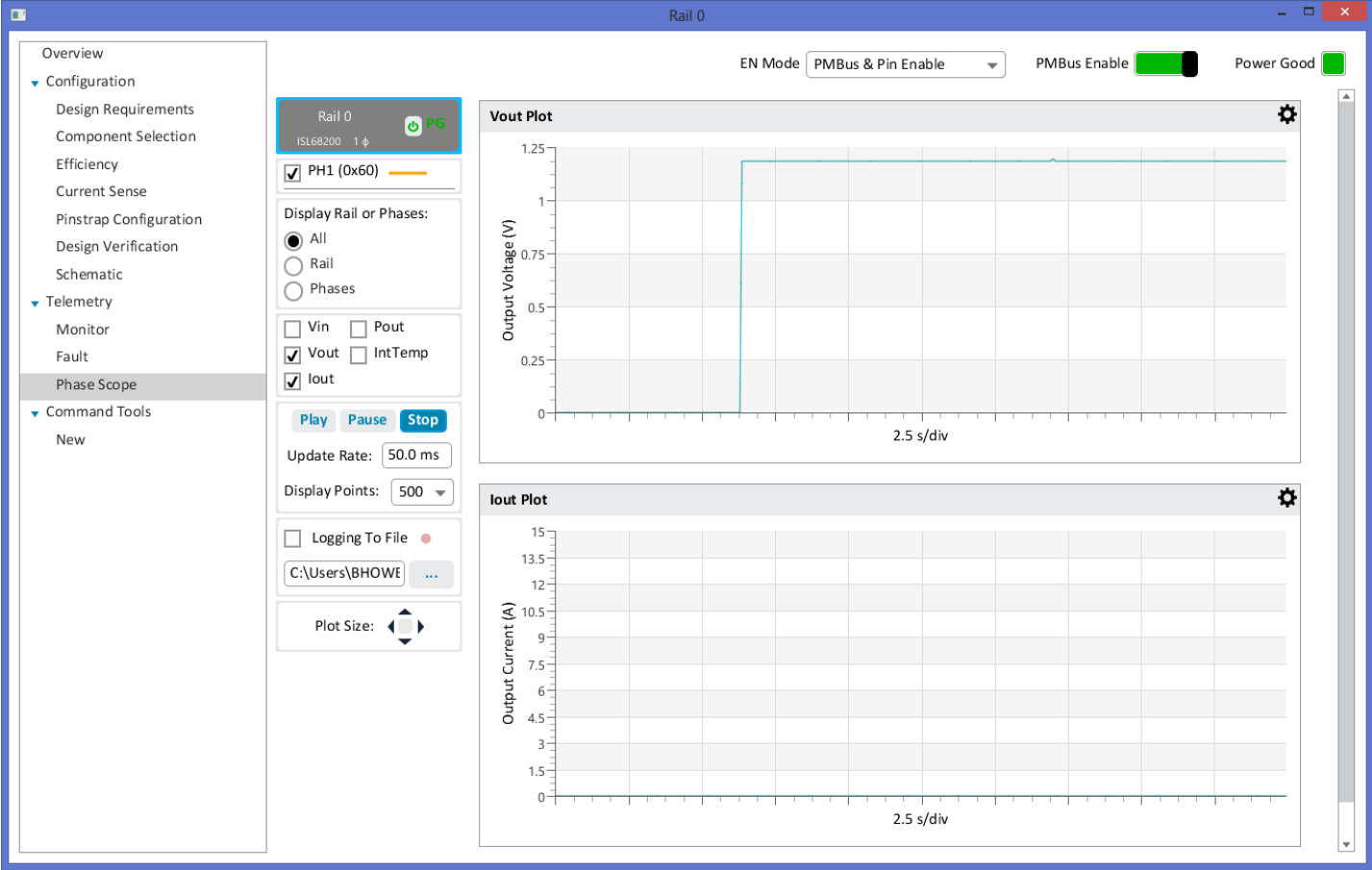

Phase Scope – Real time plotting of all telemetry parameters.

Example Rail Inspector – ISL68200

Overview

- Configuration
 - Design Requirements
 - Component Selection
 - Efficiency
 - Current Sense
 - Pinstrap Configuration
 - Design Verification
 - Schematic
- Telemetry
 - Monitor
 - Fault
 - Phase Scope
- Command Tools
 - New
 - Command Tool 0

EN Mode: PMBus & Pin Enable | PMBus Enable: On | Offline

ISL68200-0 0x60

Command Sets | Targets | Send All | Read All

Cmd: VOUT_COMMAND | Search | Send | Read

Hex: 0099 | X | 1.195 V | VOUT_COMMAND

Cmd: REAL_IOUT | Search | Read

Command Line to select PMBus command

Select Command Tool in Rail Inspector

Send/Read commands to target device

Add/Remove command lines in command tool

Example Rail Inspector – ISL68200

Clicking “Search” allows the user to quickly find any PMBus command the device supports

Command Search ISL68200 0x60

Command Code **Command Description**

Command Name

Command Group

Recent Use

d4h: AV_GAIN	d1h: TEMP_COMP
03h: CLEAR_FAULTS	d2h: ULTRASONIC_PFM_ENABLE
d0h: ENABLE_PFM	21h: VOUT_COMMAND
d3h: FAULT_BEHAVIOR	24h: VOUT_MAX
33h: FREQUENCY_SWITCH	20h: VOUT_MODE
adh: IC_DEVICE_ID	
aeh: IC_DEVICE_REVISION	
02h: ON_OFF_CONFIG	
01h: OPERATION	
98h: PMBUS_REVISION	
8ch: READ_IOUT	
dch: READ_PROG1	
ddh: READ_PROG2	
deh: READ_PROG3	
dfh: READ_PROG4	
8dh: READ_TEMP	
88h: READ_VIN	
8bh: READ_VOUT	
d6h: SET_RR	
d5h: SS_DVID_RATE	
78h: STATUS_BYTE	

Ok Cancel

Sequencing

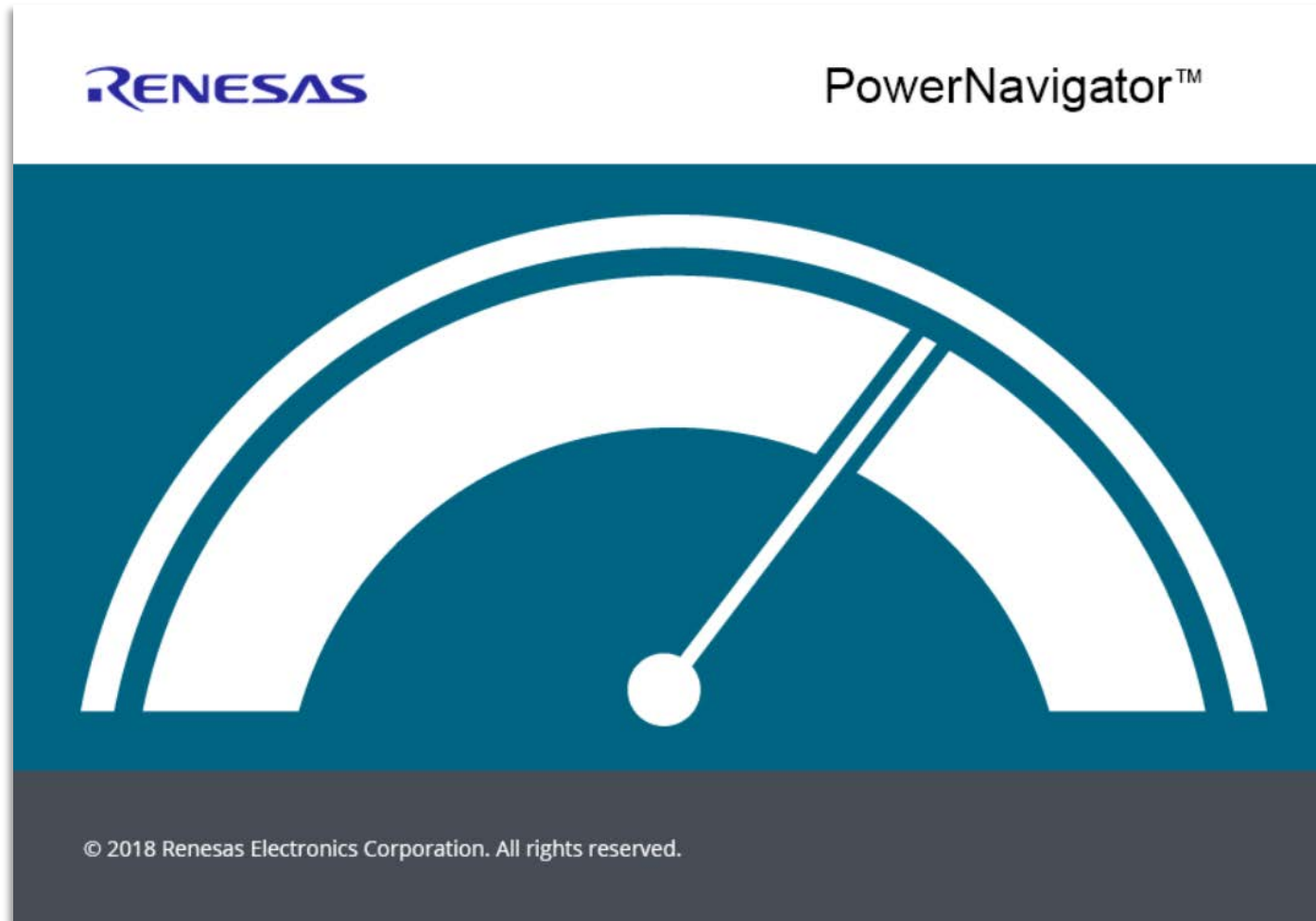

PowerNavigator – Sequencing

- All Renesas Digital Power Controllers and modules with a DDC bus support autonomous sequencing between rails.
- Sequencing is configured using the PowerNavigator sequencing tool.
- Once configured, all sequencing events are handled automatically using Renesas's proprietary DDC bus.
 - Controllers and/or modules will automatically communicate via DDC bus, synchronizing sequencing events.

PowerNavigator – System Screen

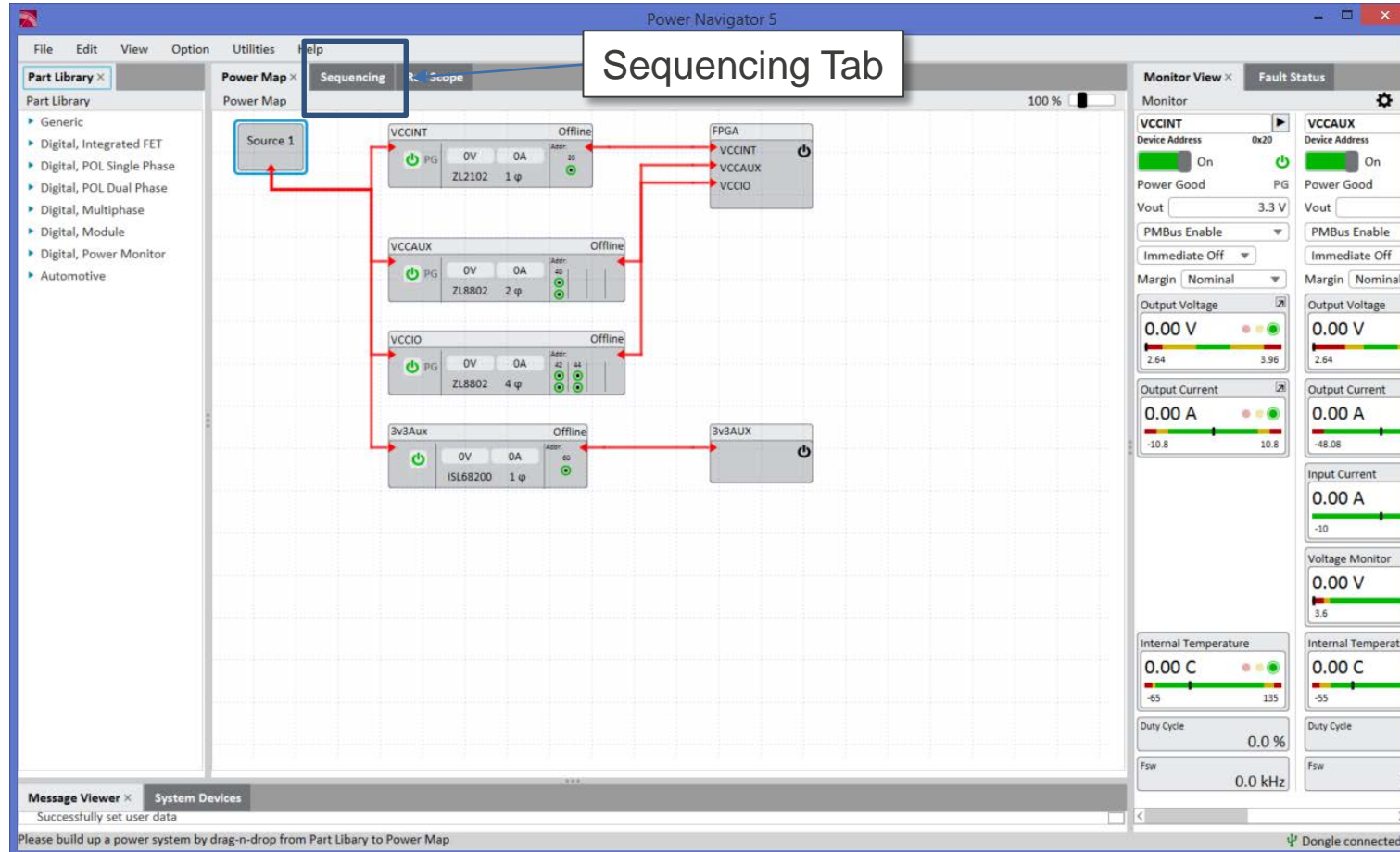

The sequencing tab allows for power up and power down sequencing of devices in the PowerMap.

PowerNavigator GUI – Sequencing

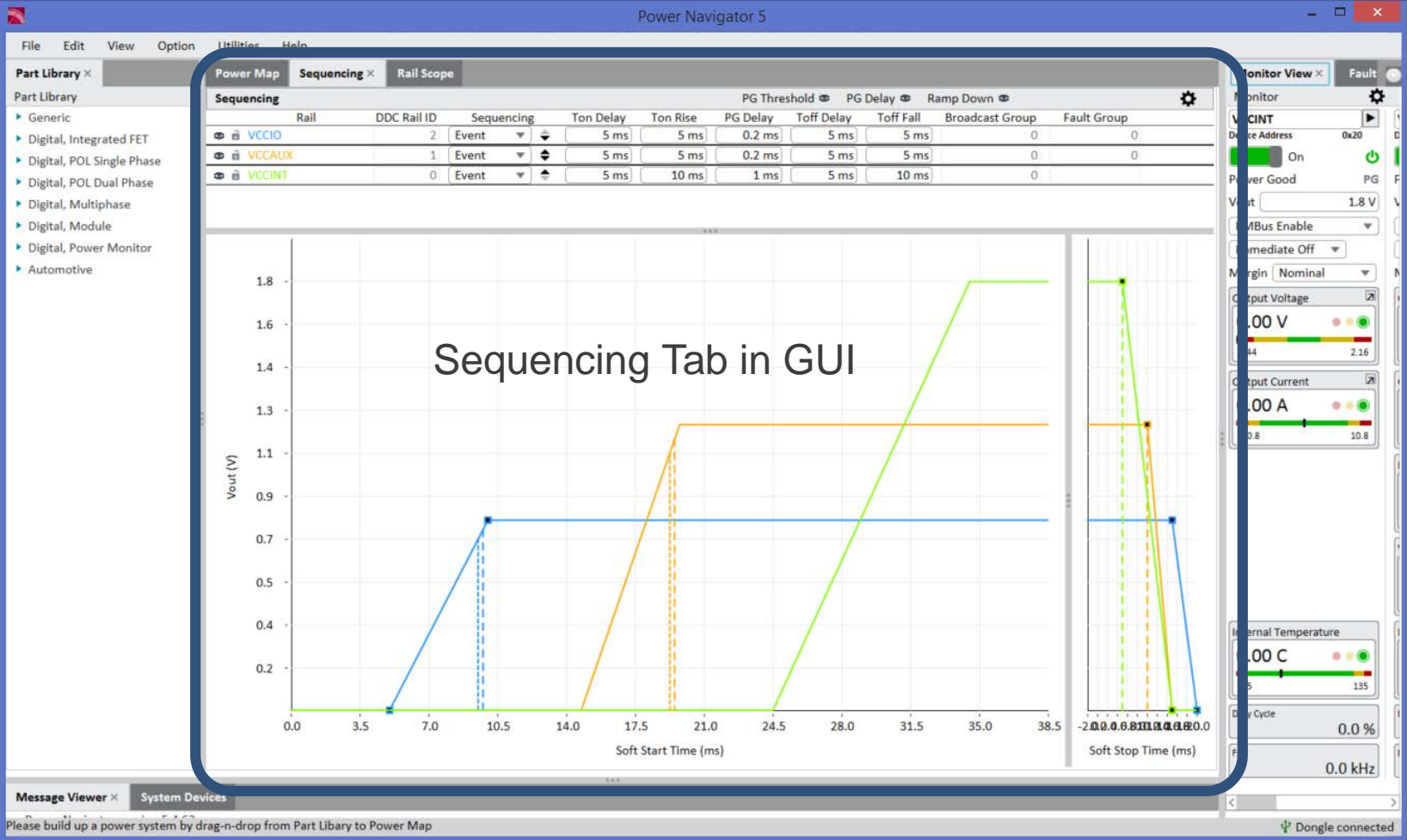

Sequencing Tab in GUI

PowerNavigator – Sequencing

- Event based sequencing waits for the device PGOOD to transition high (the event) before sequential rails start-up
 - Sequence order is set by Prequel/Sequel using the SEQUENCE PMBus command
 - TON_DELAY is used to set the time delay between sequenced rails
- Timed based sequencing uses a timer from a global enable to sequence rails at start-up.
 - TON_DELAY sets the sequence order on the way up. TOFF_DELAY sets the order on the way down.

Event Based Sequence Example

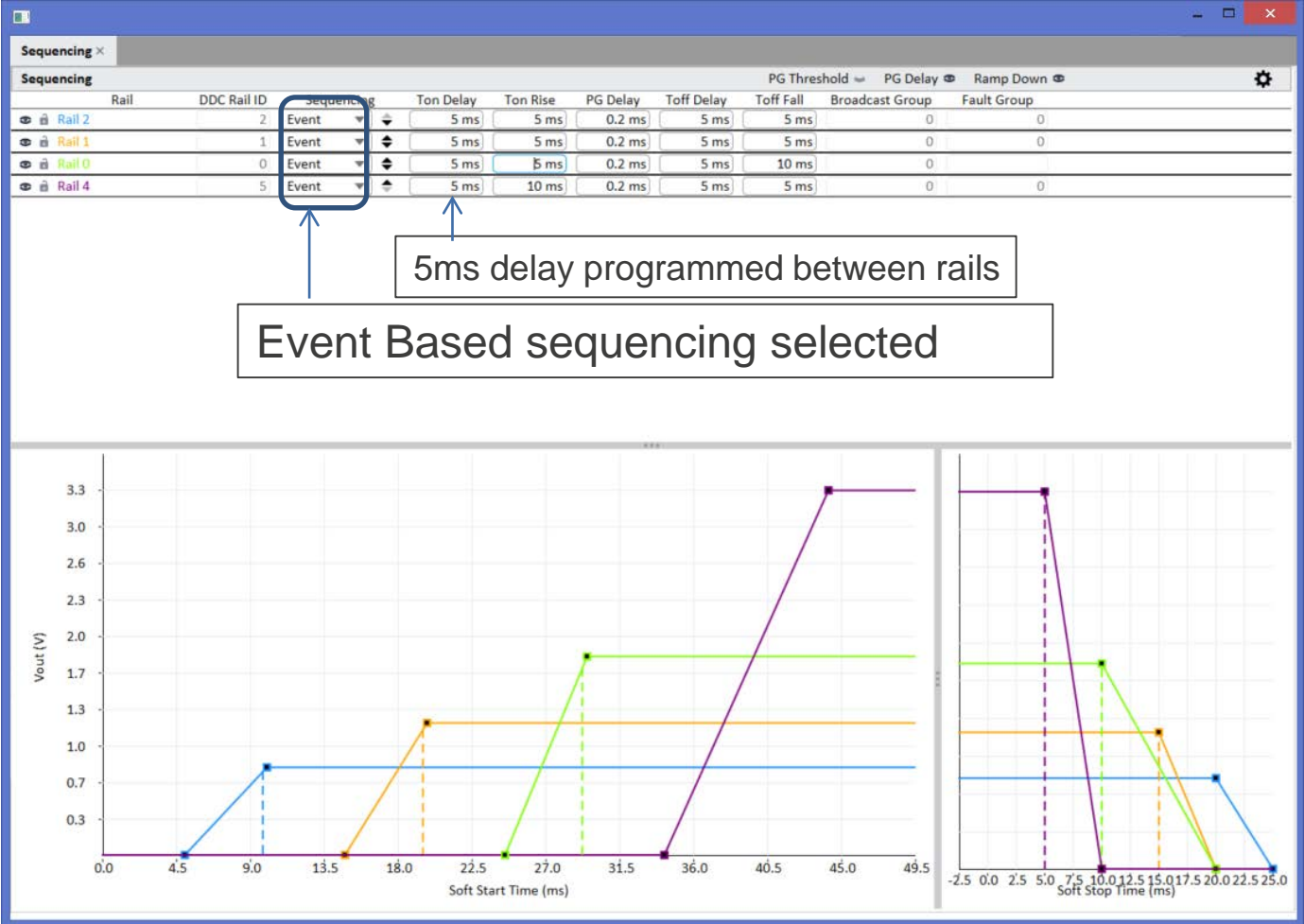

Event Based Sequence Example

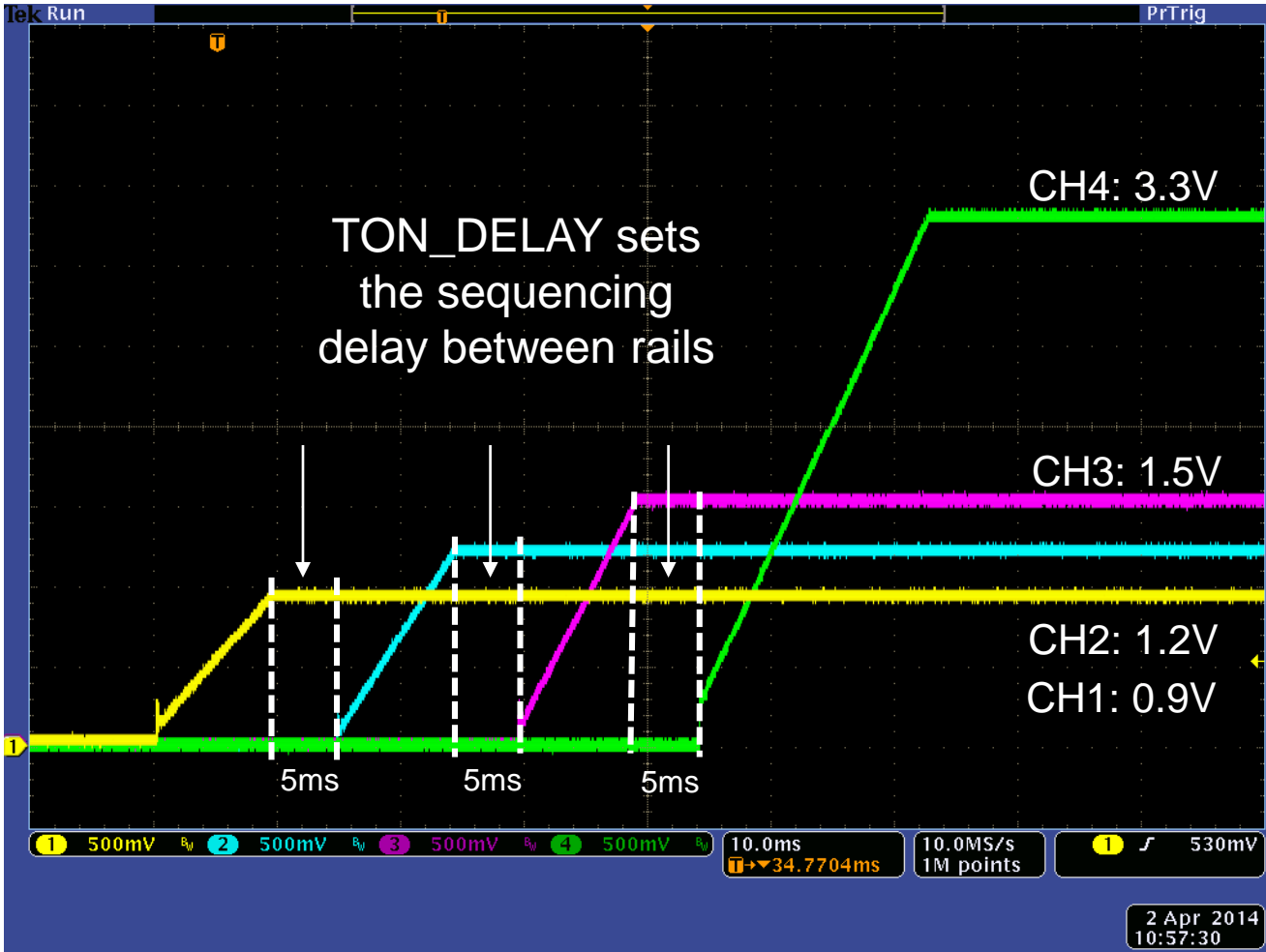

Time Based Sequence Example

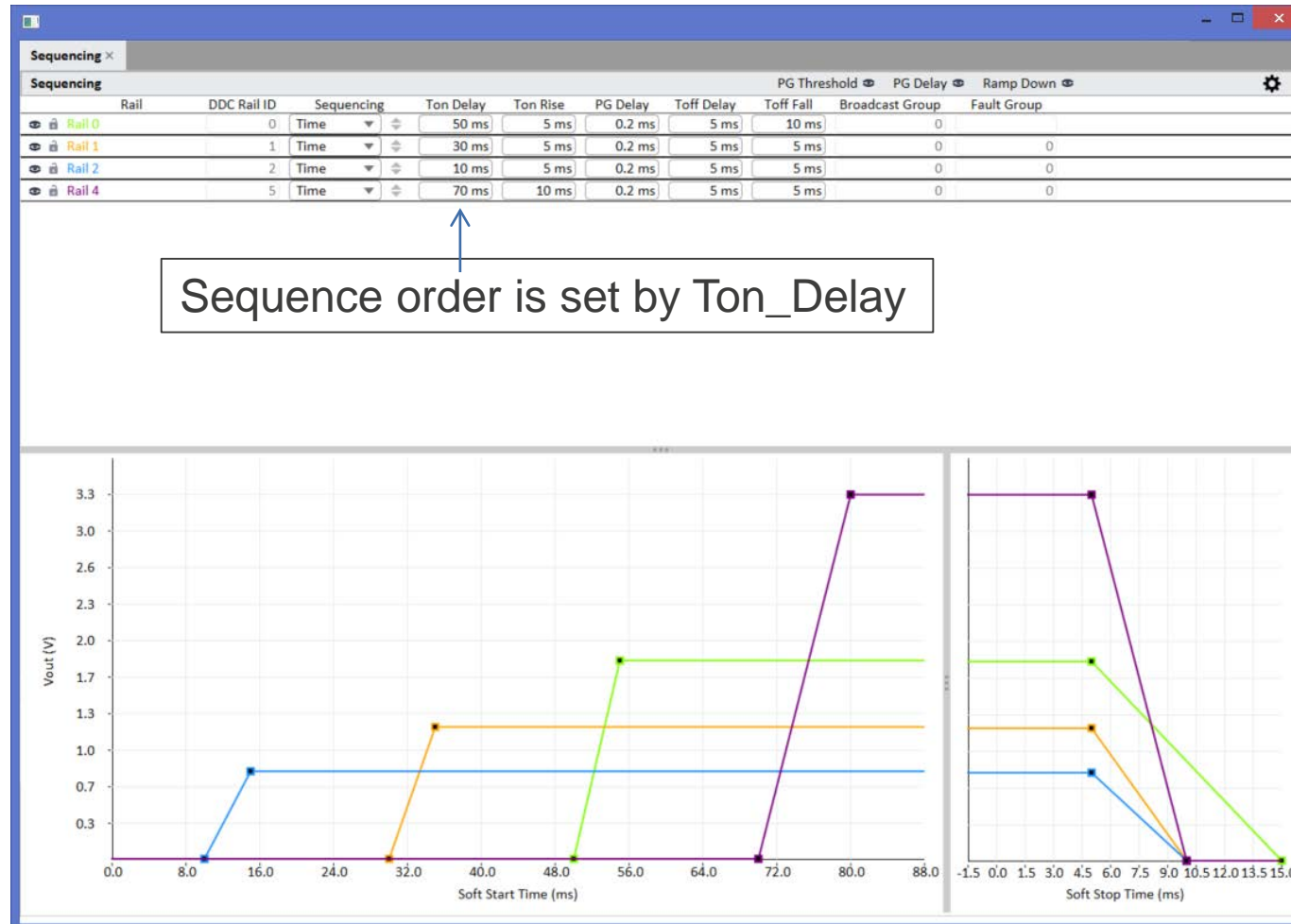

Time Based Sequence Example

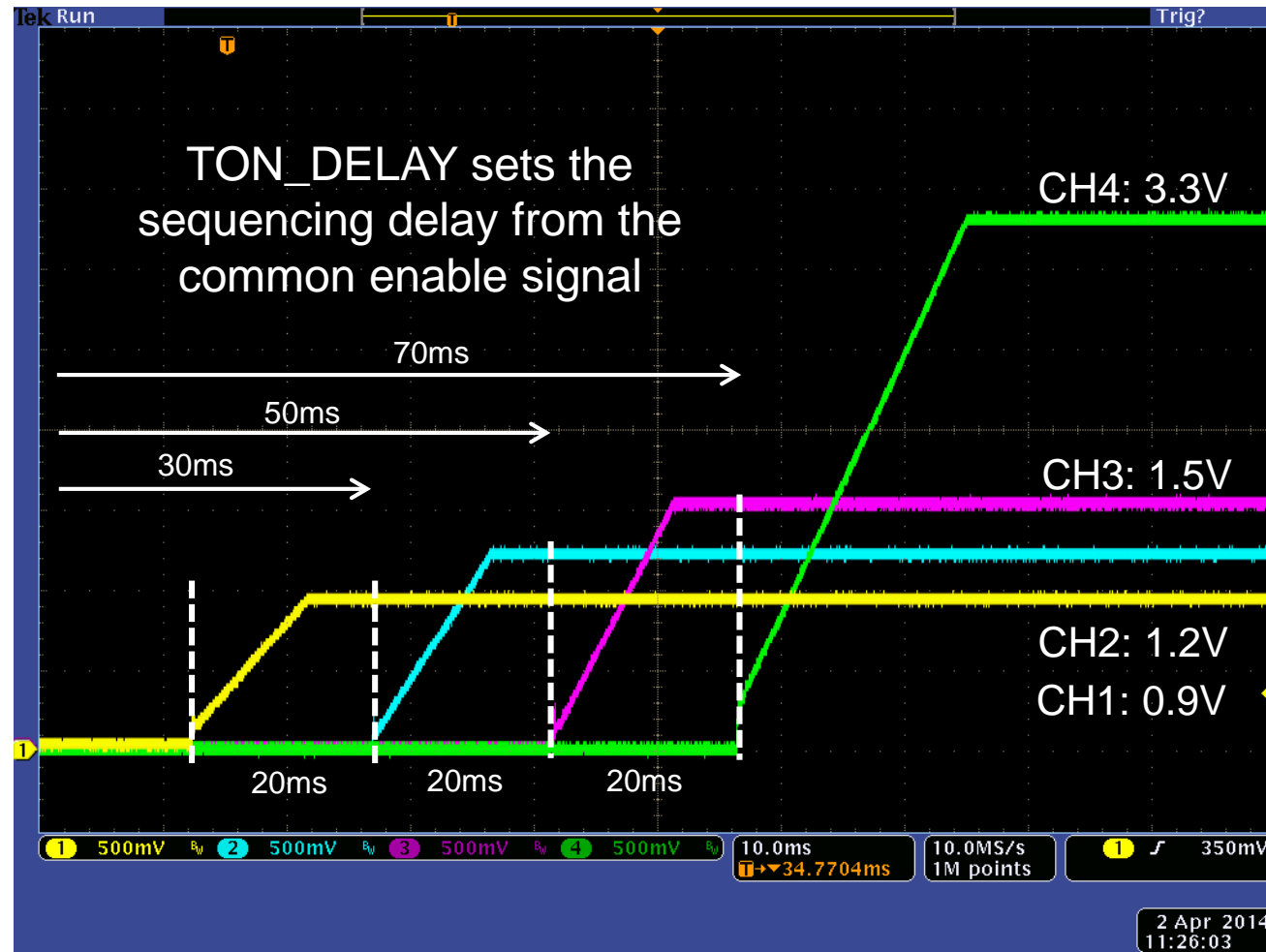

Railscope

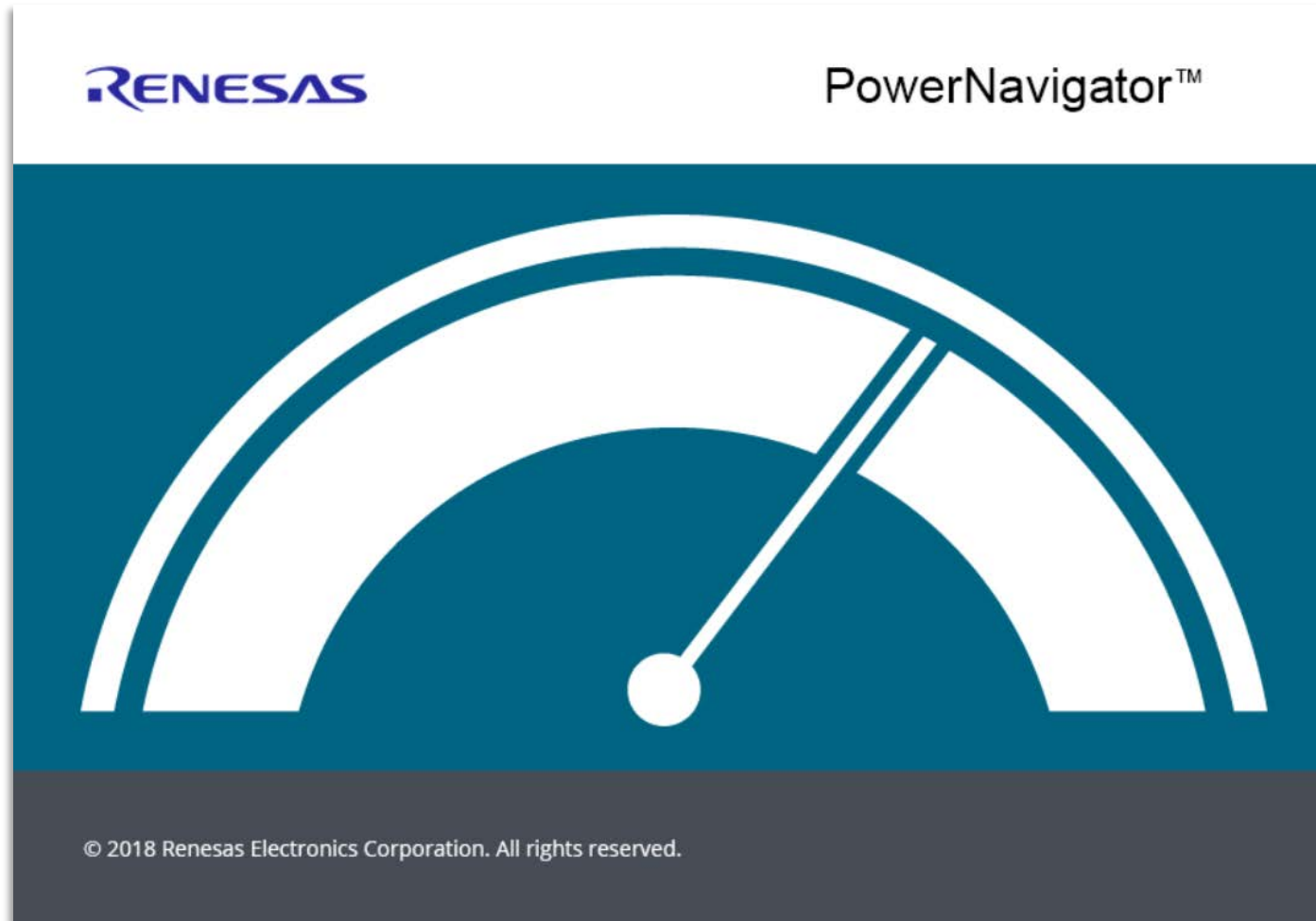

PowerNavigator 5.4 – RailScope

- New RailScope allows the user to plot telemetry parameters from up to 4 devices.
 - Similar to a Low Bandwidth Oscilloscope integrated into PowerNavigator.
 - Allows user to plot multiple telemetry values at a time.
- Logging capability is also built-in.
 - All telemetry values can be logged to a .csv file for later viewing.
 - Status registers are also logged.
- Adjustable update rate allows users to control how much data they collect.
 - Data can be updated as fast as 1ms and as slow as 1000ms.
 - Displayed points can be as few as 50 to as many as 500.

PowerNavigator – RailScope

The screenshot displays the RailScope software interface. On the left, there is a control panel for 'Rail 6' (ZL8802) with four slots (SLOT 2, 3, 4) for adding rails. Below the slots is a list of telemetry parameters: Vin, IntTemp, Iin, ExtTemp, Vout (checked), Vmon, Iout, Tmon, Pin, Vshunt, Pout, Vaux, Vdrv, and AVshunt. Further down are controls for 'Play', 'Pause', 'Stop', 'Update Rate' (50.0 ms), 'Display Poin...' (500), 'Logging To File' (checked), a file path (C:\Users\cyo), and 'Plot Size' controls.

The main area is a 'Vout Plot' showing 'Output Voltage (V)' on the y-axis (0 to 0.7) and time on the x-axis (2.5 s/div). A yellow trace shows a ramp-up from 0V to approximately 0.65V. Callouts include: 'View up to 4 Rails at one time' pointing to the slot area; 'Real time telemetry showing device ramp-up!' pointing to the rising edge of the trace; and 'Example Vout Plot' pointing to the steady-state portion of the trace.

RailScope: Initial Setup

The screenshot shows the RailScope software interface. On the left is a 'Part Library' tree. The main area contains a 'Rail Scope' window with a graph of 'Output Voltage (V)' from 0 to 0.85. A 'Load Rail' dialog box is open in the foreground, showing a list of rails (Rail 10, 11, 8, 9) and chart style options (Solid, Dashed, Dotted) with a color selection of 'ORANGE'. Four numbered callouts provide instructions: 1. Click 'View' to show RailScope. 2. Double-click on 'Slots' to add rails. 3. In the 'Load Rail' window, select a rail for each slot. 4. Click 'Ok' when done.

1 If RailScope is not visible, go to View->RailScope

2 Double Click on the "Slots" to add rails to RailScope

3 In "Load Rail" window, select rail to add to each

4 Click "Ok" when done

RailScope: 2 Telemetry Parameters

The screenshot displays the RailScope interface within Power Navigator 5. The interface is divided into several sections:

- Part Library:** A tree view on the left showing various power components.
- Power Map / Sequencing:** A central panel for configuring power rails (Rail 6, SLOTT 2, SLOTT 3, SLOTT 4) and selecting telemetry parameters.
- Telemetry Selection:** A list of parameters with checkboxes. **Vin** and **Vout** are checked, while others like IntTemp, ExtTemp, Vmon, Tmon, etc., are unchecked.
- Control Panel:** Includes Play, Pause, Stop buttons, Update Rate (50.0 ms), Display Points (500), and Plot Size controls.
- Monitor Panel:** A vertical panel on the right showing real-time data for Rail 6, including Device Address (0x46), Power Good (PG), Vout (0.8 V), Output Current (-1.02 A), Input Current (-0.36 A), Power Stage Temp (33.56 C), Internal Temperature (32.56 C), Duty Cycle (6.59%), and Fsw (533.0 kHz).
- Plots:** Two graphs are shown: **Vin Plot** (Input Voltage (V) vs. time) and **Vout Plot** (Output Voltage (V) vs. time). Both plots show a step change in voltage. A callout box points to the plot area with the text "Chart Area automatically splits into two graphs".

Annotations:

- A callout box on the left states: "Vin and Vout Telemetry Parameters selected".
- A callout box on the right states: "Chart Area automatically splits into two graphs".

RailScope: 4 Telemetry Parameters

The screenshot displays the RailScope software interface with the following components:

- Part Library:** A sidebar on the left with a tree view containing categories like Generic, Digital, and Automotive.
- Power Map / Sequencing:** A central panel showing 'Rail 6' with 'SLOT 2', 'SLOT 3', and 'SLOT 4' options.
- Parameter Selection:** A list of parameters with checkboxes: Vin, Vout, Iout, Tmon, and others.
- Control Panel:** Includes 'Play', 'Pause', 'Stop' buttons, 'Update Rate: 50.0 ms', 'Display Poin...: 500', and 'Logging To File' options.
- Chart Area:** A 2x2 grid of plots: 'Vin Plot' (Input Voltage), 'Iout Plot' (Output Current), 'Vout Plot' (Output Voltage), and 'Tmon Plot' (Power Stage Temperature). Each plot has a 2.5 s/div scale.
- Monitor View:** A right-hand panel showing real-time values for Rail 6: Output Voltage (0.80 V), Output Current (1.40 A), Input Current (-0.31 A), Power Stage Temp (34.75 C), and Internal Temperature (33.56 C).

Annotations in the image include:

- A box on the left stating: "Vin, Vout, Iout and Temp Telemetry Parameters selected" with an arrow pointing to the parameter list.
- A box at the top right stating: "Chart Area automatically splits into four graphs" with arrows pointing to the four plots.

RailScope: Example Zoom-in

The screenshot displays the RailScope software interface within the Power Navigator 5 environment. The interface is divided into several sections:

- Part Library:** A tree view on the left showing various digital power components like FETs, Single Phase, Dual Phase, Multiphase, Module, Power Monitor, and Automotive.
- Power Map / Sequencing:** A central control area for 'Rail 6' (ZL8802-2) with buttons for SLOT 2, SLOT 3, and SLOT 4. It includes checkboxes for monitoring parameters: Vin, Iin, Vout, Iout, Pin, Pout, Vdrv, IntTemp, ExtTemp, Vmon, Tmon, Vshunt, and AVshunt. Controls for Play, Pause, Stop, and an Update Rate of 50.0 ms are also present.
- Plots:** Four real-time plots are shown:
 - Vin Plot:** Input Voltage (V) vs. time, showing a steady state at approximately 12.5V.
 - Iout Plot:** Output Current (A) vs. time, showing a steady state around 1.0A.
 - Vout Plot:** Output Voltage (V) vs. time, showing a steady state at 0.80V. A yellow rectangular area is highlighted on this plot, indicating a zoomed-in region.
 - Tmon Plot:** Power Stage Temperature (C) vs. time, showing a steady state around 32.06C.
- Monitor View:** A panel on the right providing detailed status for 'Rail 6':
 - Device Address: 0x46
 - Power Good: PG (green indicator)
 - Vout: 0.80 V
 - Output Voltage: 0.80 V (range 0.64 to 0.96)
 - Output Current: 0.97 A (range -120.15 to 288)
 - Input Current: -0.31 A (range -10 to 10)
 - Power Stage Temp: 32.06 C (range -45 to 125)
 - Internal Temperature: 31.06 C (range -55 to 135)
 - Duty Cycle: 6.3 %
 - Fsw: 533.0 kHz

A callout box with a blue arrow points to the yellow highlight in the Vout plot, containing the text: "Click and drag to highlight zoom area in chart. Double click to return to previous Zoom level."

RailScope: Example X & Y-axis Scale Options

The screenshot displays the Power Navigator 5 interface with the RailScope window open. The interface includes a menu bar (File, Edit, View, Option, Utilities, Help), a Part Library on the left, and a central area with several plots: Vin Plot, Vout Plot, Iout Plot, and Tmon Plot. A 'Set Bounds for Vout' dialog box is overlaid on the Iout Plot, showing 'Auto Ranging' checked and 'Lower bound: 0.0' and 'Upper bound: 5.0' set. A 'Monitor View' panel on the right shows various system metrics like Output Voltage (0.80 V), Power Stage Temp (34.75 C), Internal Temperature (33.56 C), Duty Cycle (6.32%), and Fsw (533.0 kHz). Annotations with arrows point to specific UI elements: a gear icon in the Vin Plot, the 'Auto Ranging' checkbox, and the 'Update Rate' and 'Display Point' settings in the control panel.

Click Toolbox icon to bring up y-axis limits box

X-axis scale is set by update rate and display point user settings

When "Auto Ranging" check box is clicked, PowerNavigator will auto-set y-axis scale

Unchecking "Auto Ranging" box allows user to set upper and lower bounds

RailScope: Logging Feature

- Once enabled, logging feature will automatically log all selected telemetry parameters and the STATUS_WORD register for each device.
- All data is saved to a .csv file, which can be opened in Excel for later data analysis.
 - Once the .csv file size exceeds 50MB, a new file will automatically be created.
 - There is no limit on how long logging can run for.
- The log file name and path can be changed by the end user.



RailScope: Example Log File

PN5p2_TelemetryLog.0.0.csv [Read-Only] - Excel

Telemetry parameters for "VCCIO" rail

Telemetry parameters for "AUX" rail

TimeStamp	VCCIO_STATUS	VCCIO_Vin	VCCIO_Vout	VCCIO_Iout	VCCIO_IntTemp	AUX_STATUS	AUX_Vin	AUX_Vout	AUX_Iout	AUX_IntTemp	CORE_STATUS
23/04/2015 10:58:04.0225	0x0000	11.921875	0.800292969	-0.048583984	32.1875	0x0000	11.890625	1.001953125	0.373046875	51.125	0x0000
23/04/2015 10:58:04.0467	0x0000	11.921875	0.799682617	-0.047790527	31.71875	0x0000	11.875	1.001953125	0.387695313	51.625	0x0000
23/04/2015 10:58:04.0667	0x0000	11.9375	0.799682617	-0.047363281	31.84375	0x0000	11.890625	1.003540039	0.320800781	51.625	0x0000
23/04/2015 10:58:04.0867	0x0000	11.953125	0.800292969	-0.047485352	32.125	0x0000	11.890625	1.003540039	0.334472656	51.125	0x0000
23/04/2015 10:58:05.0067	0x0000	11.9375	0.800048828	-0.04876709	31.90625	0x0000	11.890625	1.005249023	0.386230469	51.625	0x0000
23/04/2015 10:58:05.0268	0x0000	11.921875	0.800292969	-0.047485352	31.9375	0x0000	11.890625	1.003540039	0.357421875	51.625	0x0000
23/04/2015 10:58:05.0468	0x0000	11.921875	0.801513672	-0.049682617	32.0625	0x0000	11.890625	1.003540039	0.37890625	51.625	0x0000
23/04/2015 10:58:05.0669	0x0000	11.921875	0.800048828	-0.047790527	31.71875	0x0000	11.890625	1.005249023	0.374023438	51.125	0x0000
23/04/2015 10:58:05.0869	0x0000	11.9375	0.800048828	-0.047485352	31.71875	0x0000	11.890625	1.001953125	0.358886719	51.125	0x0000
23/04/2015 10:58:06.0069	0x0000	11.9375	0.799682617	-0.048400879	31.9375	0x0000	11.890625	1.003540039	0.329101563	51.625	0x0000
23/04/2015 10:58:06.0269	0x0000	11.96875	0.800048828	-0.04510498	31.625	0x0000	11.890625	1.003540039	0.37890625	51.125	0x0000
23/04/2015 10:58:06.0471	0x0000	11.953125	0.800048828	-0.046142578	31.9375	0x0000	11.890625	1.003540039	0.427246094	51.125	0x0000
23/04/2015 10:58:06.0671	0x0000	11.921875	0.80065918	-0.048156738	31.78125	0x0000	11.890625	1.003540039	0.387695313	51.625	0x0000
23/04/2015 10:58:06.0871	0x0000	11.9375	0.800048828	-0.047363281	31.84375	0x0000	11.890625	1.003540039	0.368164063	51.125	0x0000

Each telemetry entry is time stamped

Rail name can be set by user (taken from PowerMap)

HEX File Creation

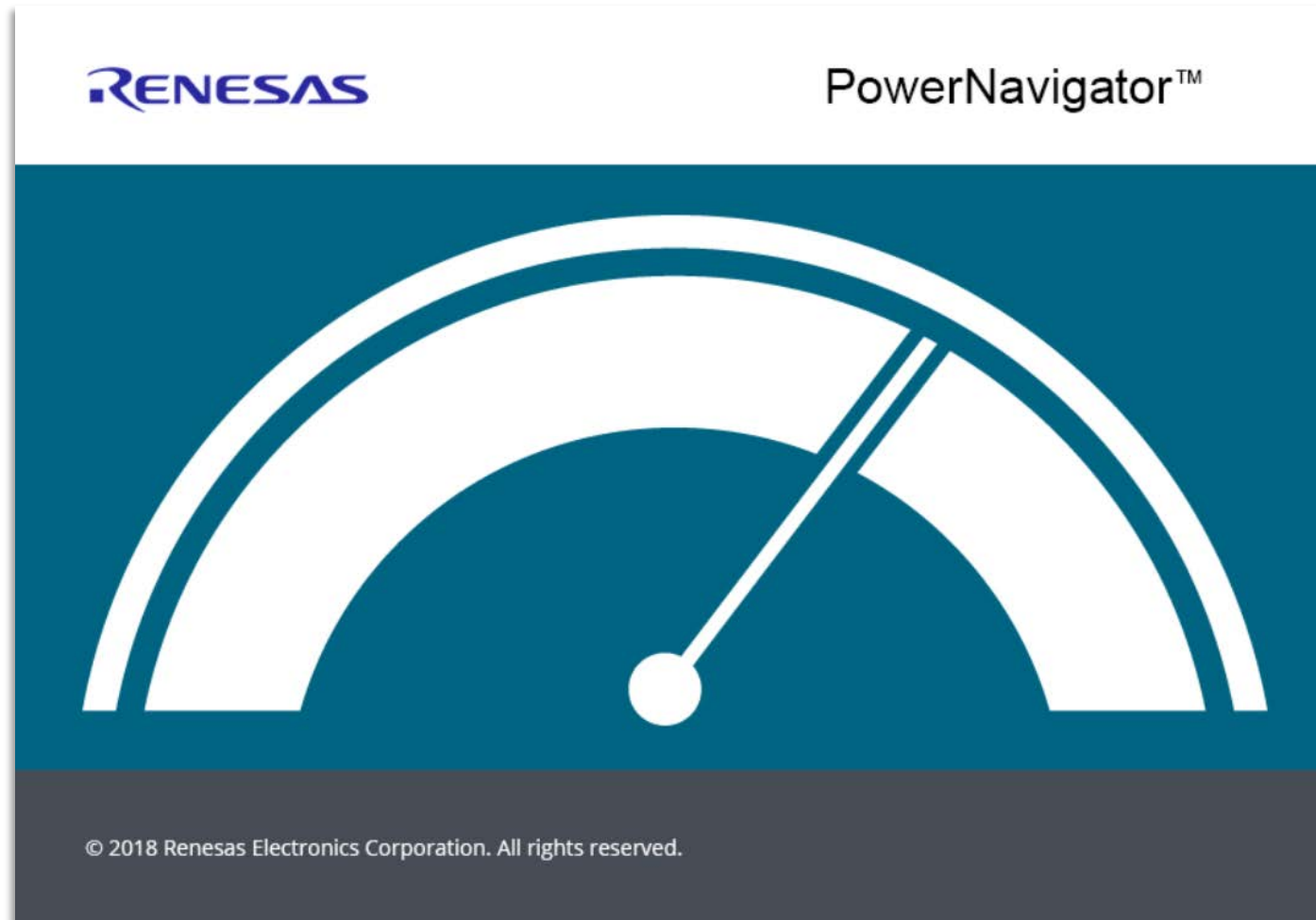

Configuration File Overview

- Renesas Digital Power controllers use configuration files to program important device parameters.
 - Configuration files are basically a list of PMBus commands defining device operation. i.e. `Vout_Command = 1.0V`, `Iout_Cal_Gain = 0.5mV/A`, etc.
- Device configuration only needs to be done one time – programmed parameters are stored inside non-volatile memory for future use. NVM supports multiple writes and is re-programmable.
- Several Options are available for programming devices in a production environment.

Programming Devices in Manufacturing Environment

Option 1: Program controllers pre-board assembly

- Devices are programmed on a high speed production programmer before being assembled on a board.
- Can use a supported 3rd party programming house OR offline programmer at sub-contractor.

Option 2: Program controllers after board assembly

- Devices are programmed on PCB post board assembly
- Can be done at ICT (using a bed of nails approach or onboard microcontroller) OR using Renesas dongle and Production Configuration Tool (PCT).
- Requires board to be powered up with all controllers DISABLED until they are fully programmed.

Typical Flow – Pre-Programmed Devices

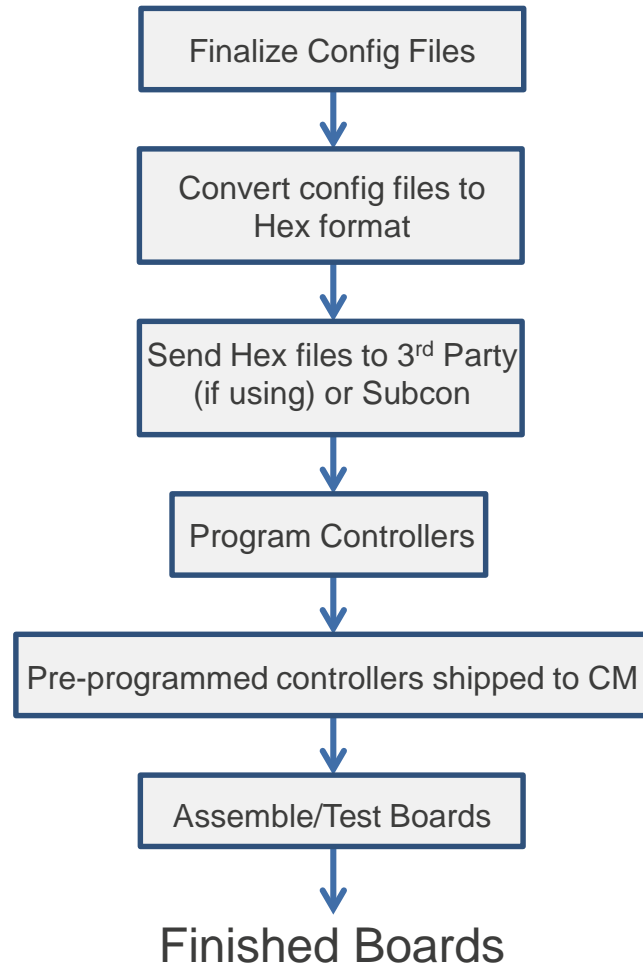

- Controllers are programmed prior to PCB manufacture.
- Hex files are created using PowerNavigator software (File->Export Production Hex).
- Programming is done either with a 3rd party or using offline programmer at subcon.
- Typical programming time: 4-7 seconds per device.
- Individual part numbers are assigned to each device after programming to make sure boards are assembled correctly.

Typical Flow – Programming Parts on Board

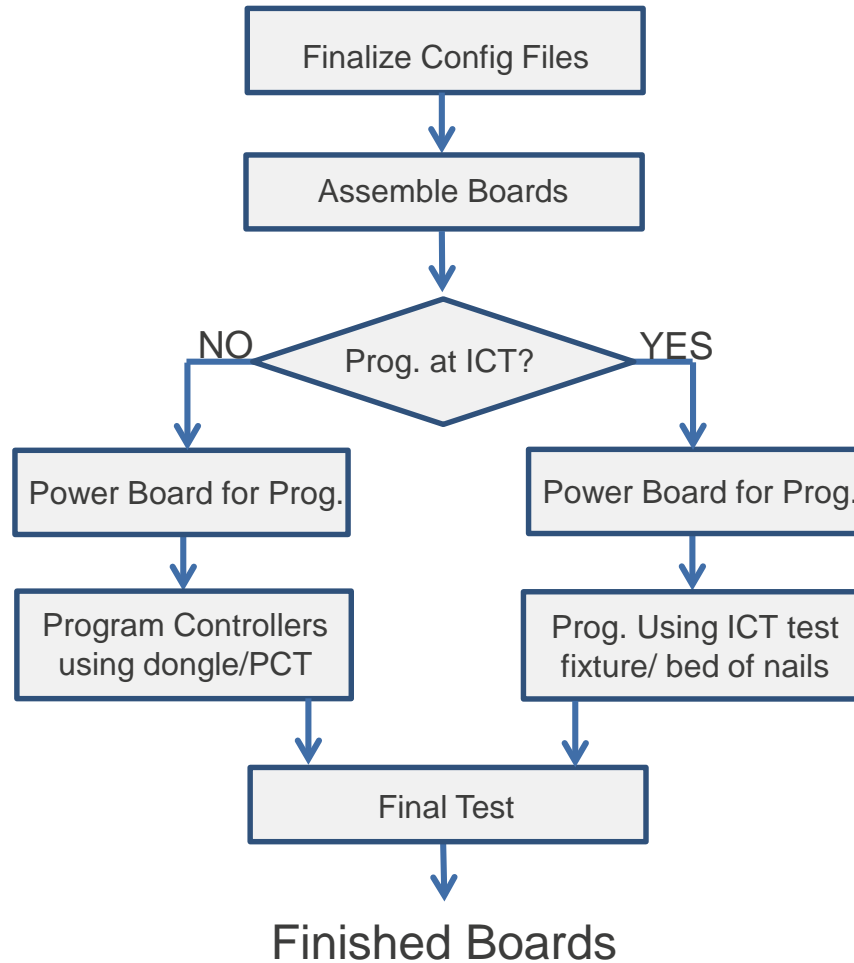

- Controllers are programmed after board assembly.
- Typical Programming time: 5-10s per device.
- Simplified inventory and configuration file management.
- Controllers must be powered to program, but output must remain disabled until part is fully programmed.
- Special attention to sequencing must be made when using self-enabled parts.

HEX File Creation – Step 1, Project Save

Step 1: To create a production HEX file, first save your project

NOTE: Before saving a project, the HW enable pin on all controllers must be held low.

NOTE: All Project files are stored in the directory:
C:\Users\USERNAME\Documents\Intersil\PowerNavigator\Projects

HEX File Creation – Step 2, Export HEX Files

Step 2: Go to File -> Export Production Hex

Click "Export"

NOTE: All Production HEX files are stored in the saved project folder, located in the directory:
C:\Users\USERNAME\Documents\Intersil\PowerNavigator\Projects

Select	Device	Rail(s)	Programming Address (for programming house only)	Output Hex Filename (.hex)
<input checked="" type="checkbox"/>	ZL2102-0 0x20	VCCINT	0x20	ZL2102-0
<input checked="" type="checkbox"/>	ZL8802-0 0x40	VCCAUX	0x20	ZL8802-0
<input checked="" type="checkbox"/>	ZL8802-1 0x42	VCCIO	0x20	ZL8802-1
<input checked="" type="checkbox"/>	ZL8802-2 0x44	VCCIO	0x20	ZL8802-2

Example HEX File Creation

This utility converts configuration data saved in human-readable format into the proper hex format used for production programming.

What is the programming address? The PMBus address during production programming can differ from the in-system address. A programming socket might use address 0x20 while final in-system address is 0x36. Ask your programming house which address is needed.

Project location: C:\Users\cyoung07\Documents\Intersil\PowerNavigator\Projects\example

Select	Device	Rail(s)	Programming Address (for programming house only)	Output Hex Filename (.hex)
<input checked="" type="checkbox"/>	ZL2102-0 0x20	VCCINT	0x20	ZL2102-0
<input checked="" type="checkbox"/>	ZL8802-0 0x40	VCCAUX	0x20	ZL8802-0
<input checked="" type="checkbox"/>	ZL8802-1 0x42	VCCIO	0x20	ZL8802-1
<input checked="" type="checkbox"/>	ZL8802-2 0x44	VCCIO	0x20	ZL8802-2

Export

Devices from PowerMap automatically populated

Programming address is address used on High Speed programmer socket

HEX file name can be set by user

Example Configuration File

```
# ZL8800-0 0x28
# connected: true
# DEVICE_ID          ZL8800----01.04
# IC_DEVICE_ID      0x49A02400
# IC_DEVICE_REV     0x01040000
```

Header information with device type, FW version, creation date, etc.

```
# 2014/01/16 17:55:45000
RESTORE_FACTORY
STORE_DEFAULT_ALL
STORE_USER_ALL
```

This sequence of commands is used to clear contents of NVM.

```
### Begin User Store
RESTORE_USER_ALL
```

```
# Global commands
FREQUENCY_SWITCH          0xfa50      # 296 kHz
VIN_OV_FAULT_LIMIT       0xd380      # 14 V
VIN_OV_FAULT_RESPONSE    0x80
VIN_OV_WARN_LIMIT        0xd360      # 13.5 V
VIN_UV_WARN_LIMIT        0xca5e      # 4.734 V
VIN_UV_FAULT_LIMIT       0xca4c      # 4.594 V
VIN_UV_FAULT_RESPONSE    0x80
IIN_CAL_GAIN              0xba00      # 1 mV/A
USER_GLOBAL_CONFIG        0x80
VMON_OV_FAULT_RESPONSE    0x80
VMON_UV_FAULT_RESPONSE    0x80
PRIVATE_PASSWORD
PUBLIC_PASSWORD
```

Programmed device parameters

Example HEX File

```
000340F499  
000440F10087  
0003401530  
000440F10087  
000340112C  
000440F10087  
00054046C0DB82  
0005404B80D562  
000540E720DBE2  
000540E800D628  
000440D80193  
00054038E9C295  
0005403924C4E8  
000540D0C0AB01  
000440DCAC8D  
000D40D50940CC7BF0AEFC60997B74  
000540D750A2C9  
000340112C  
000440F10087  
0003401225  
000440F10087
```

Configuration file translated into machine readable HEX format.

BIG IDEAS FOR EVERY SPACE

Renesas.com