

ZSSC3240 CURRENT LOOP / OWI

ZSSC3240 Configuration

Recommended AFE configuration for test application using the Sensor Replacement Board

Default mode is the Cyclic Mode. After IC-reset the ZSSC3240 starts autonomously the measurements.

OWI interface is activated for 50ms after IC-reset.

If in this period the command 0xD9 (START_UP_OWI) is received, the ZSSC240 stays in OWI communication mode. Otherwise it provides the measurement results after 50ms at AOUT.

SM Config 1/2		Ext. Temp. Config 1/2	
Gain	28	Gain	1.32
Polarity	Positive	Polarity	Positive
ADC Resolution	16 Bit	ADC Resolution	16 Bit
ADC Offset	44%	ADC Offset	0%
ADC Reference	Ratiometric	ADC Reference	Bandgap
IOffsC	0mV (no shift)	IOffsC	0mV (no shift)
Tbias out	5uA	Tbias out	5uA
ADC Gain/Offset	On	ADC Gain/Offset	Off
CM Adjustment	On	CM Adjustment	Off

Smart Sensor Feature Reg. 1		Smart Sensor Feature Reg. 2	
Default Mode	Cyclic Mode	DAC resolution	13Bit
OWI Listen Time	50ms	Dithering	Dithering Off
OWI SU Case	Startup Window	DAC Input	Sensor -> DAC
Temp. Source	internal PTAT	Analog Out	DAC Output enabled
Sensor Supply	Ratiometric Supply VDDB	Aout Setup	Current loop / OWI1 / OWI2
Internal Rt	1.3kOhm	Diagnostc	Analog Diagnostic Off
External Rt	No	LDOctrl	On
OWI off	OWI enabled	LDOctrl Voltage	VDD = 4.8V
NVM lock	NVM write OK	AZ Sensor	AZM Sensor Off
Charge Pump	On	AZ Temp.	AZM Temp. Off
		Oversampling	No Overs.

Desired DAC resolution

Sensor choice for analog output

DAC functionality has to be enabled

Necessary configuration for Current Loop application in combination with OWI.

Desired regulated VDD voltage

ZSSC3240 CURRENT LOOP / OWI HW SETUP

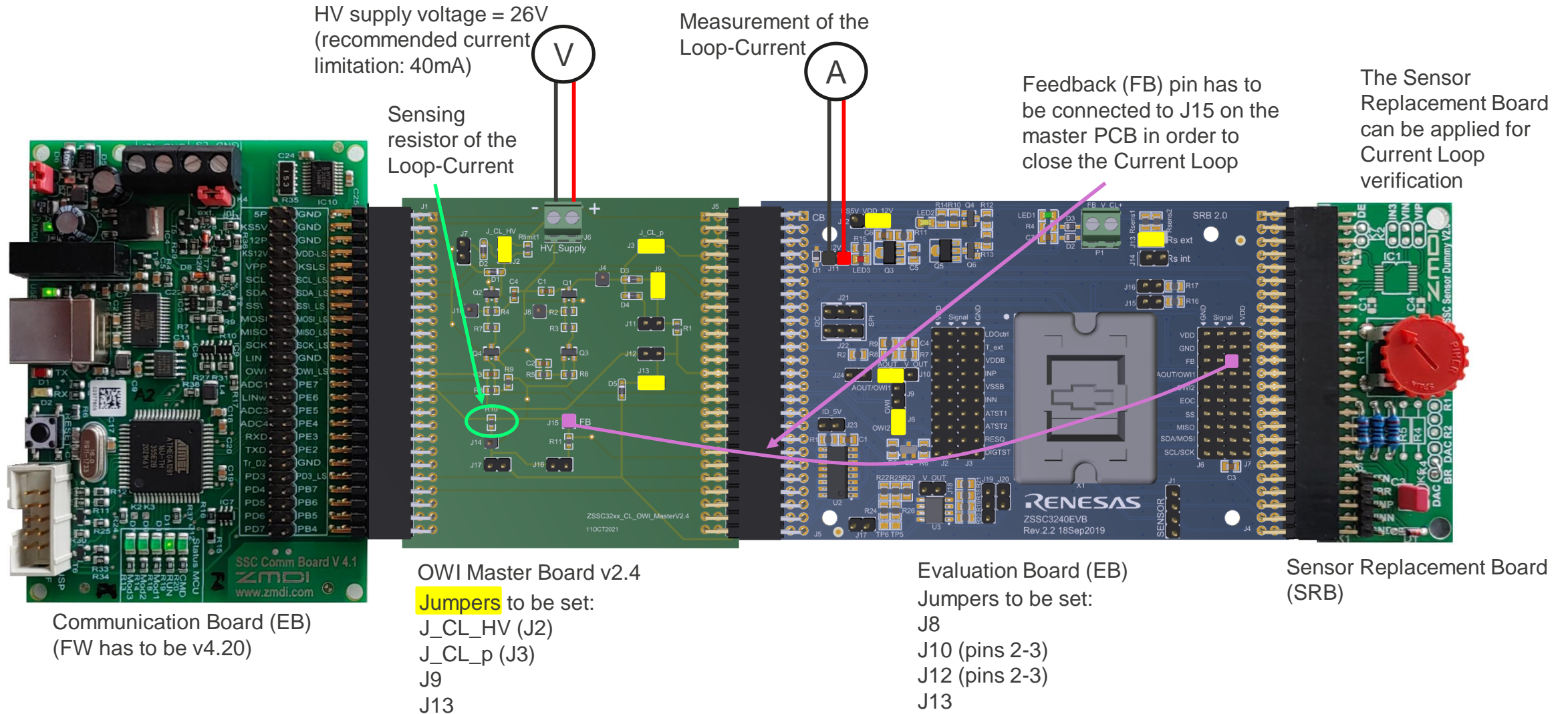

CB FW UPDATE FOR OWI IN CURRENT LOOP

For the ability of the CB to decode OWI communication, in combination with Current Loop, the firmware (FW) of the CB has to be updated to revision V4.20.

The recent FW revision, Bootloader and the documentation for the updating process are available at the Renesas site:

<https://www.renesas.com/us/en/products/sensor-products/sensor-signal-conditioners-ssc-afe/ssc-cb-ssc-communication-board>

Follow the instructions in the *Communication Board Firmware Update* Application Note for flashing the FW version 4.20 to the CB controller.

After a successful flashing process, the HW information in the ZSSC3240 GUI displays the FW version:

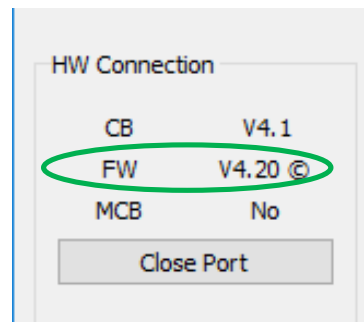

ZSSC3240 CURRENT LOOP - POWER UP

After ZSSC3240 configuration, HW connection, and FW flashing:

1. Connect the Communication Board via USB to a host PC and turn on HV supply (26V)
⇒ No current should be flowing in the Loop
2. Start the ZSSC3240 Evaluation SW
⇒ KS5V is set to 5V when the GUI is loaded, it enables the HV supply to EB. The Current Loop is supplied.
⇒ ZSSC3240 is in Cyclic Mode, providing the measurement result at AOUT pin. The AOUT voltage is driving the CL current.

ZSSC3240 GUI after launching

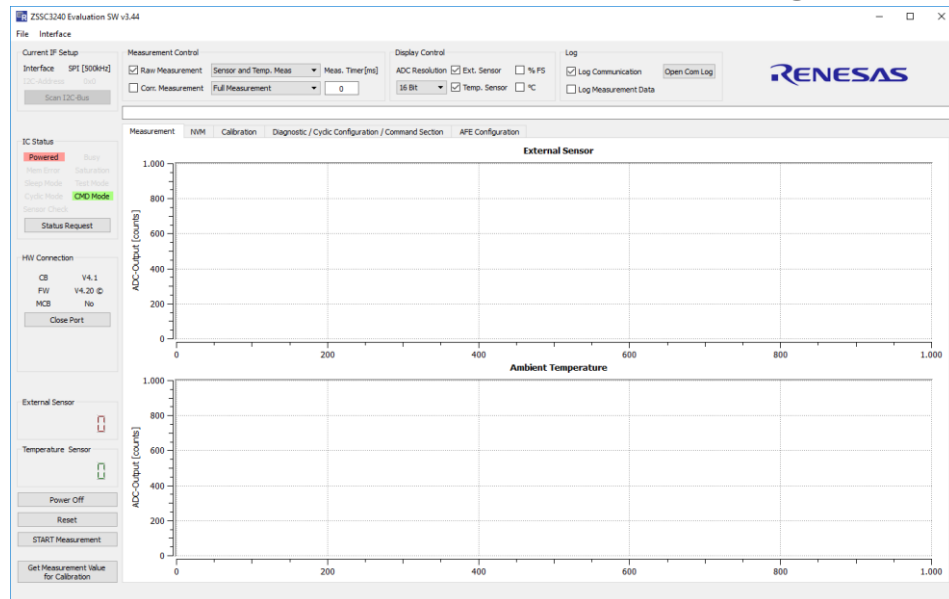

Scoping the signals after GUI start

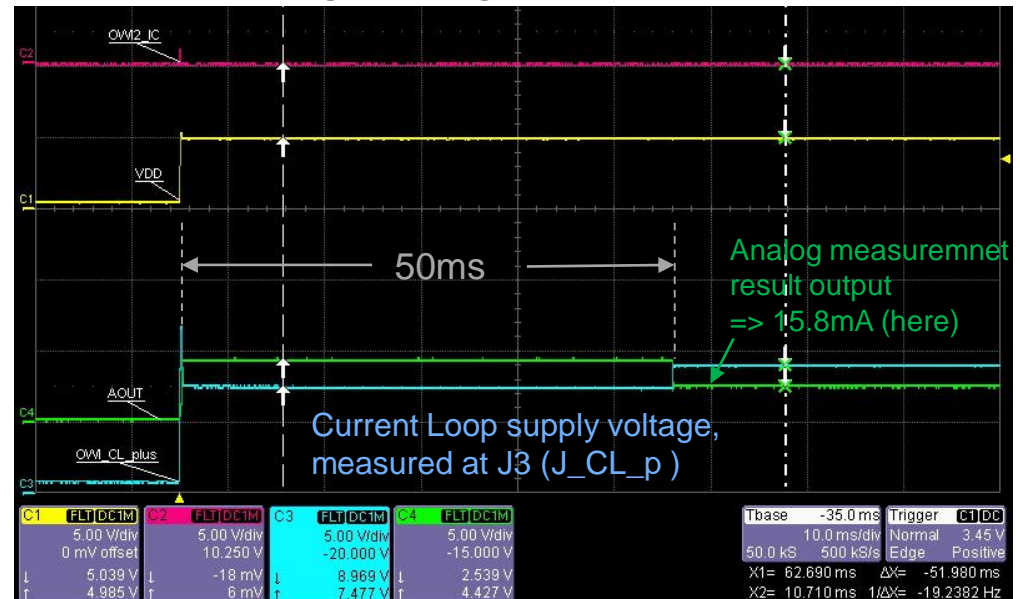

SW CONFIGURATION FOR OWI COMMUNICATION

1. Switch to OWI interface:
Menu -> Interface -> OWI

2. CB configuration to decode the ZSSC3240 OWI output (modulated on the Loop-Current):
Diagnostic / Cyclic... / Command Section tab -> OWI Master -> OWI Master Application

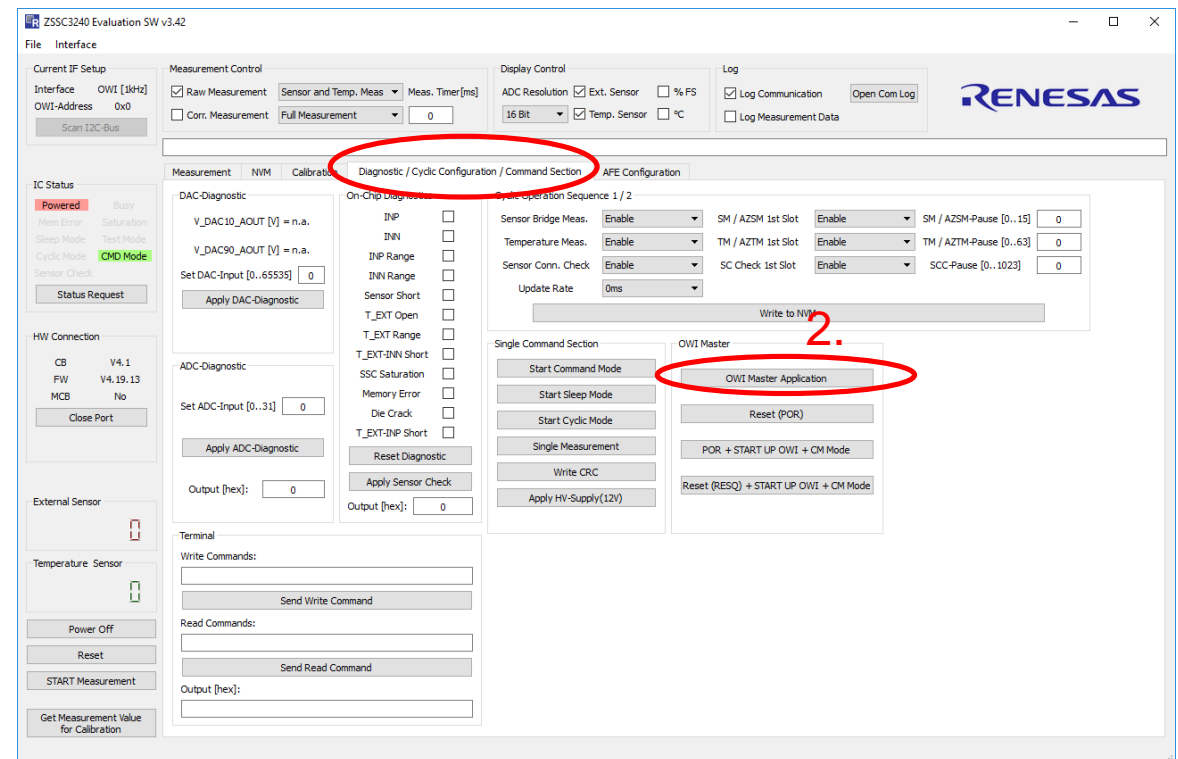
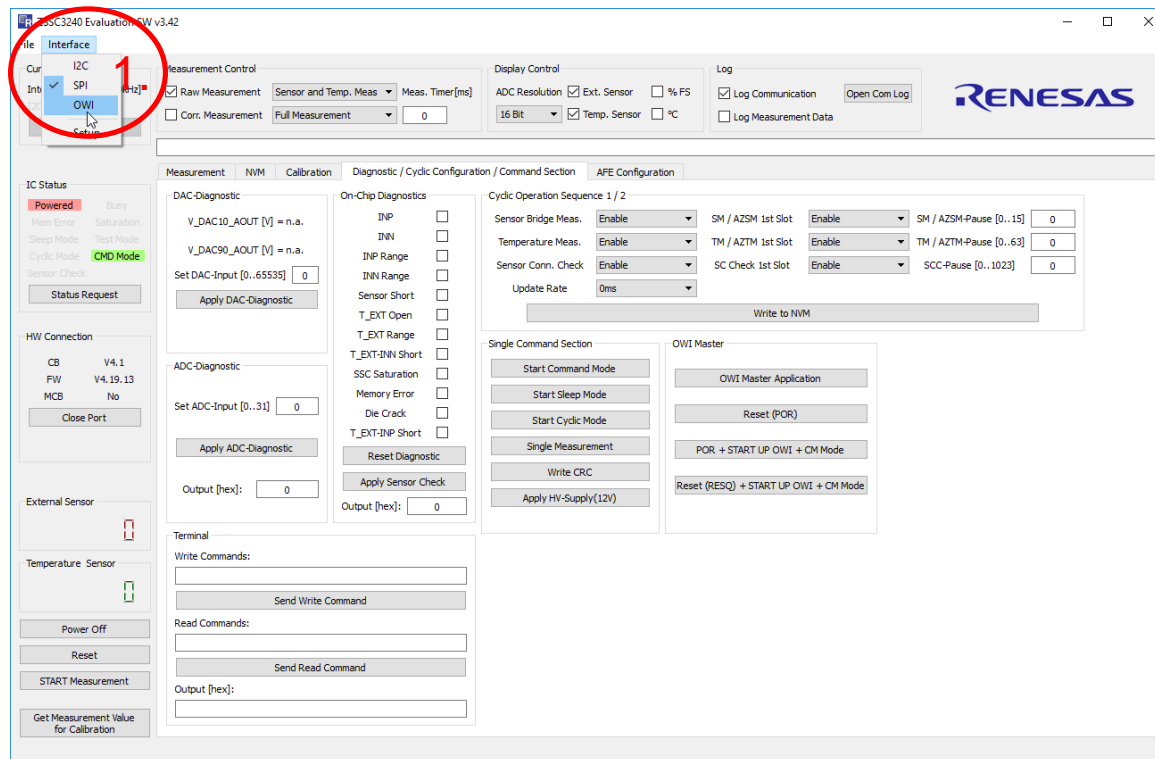

SWITCH FROM CYCLIC MODE TO COMMAND MODE

POR (Power-On Reset)

Diagnostic / Cyclic... / Command Section tab -> OWI Master -> POR START_UP_OWI_CM_Mode

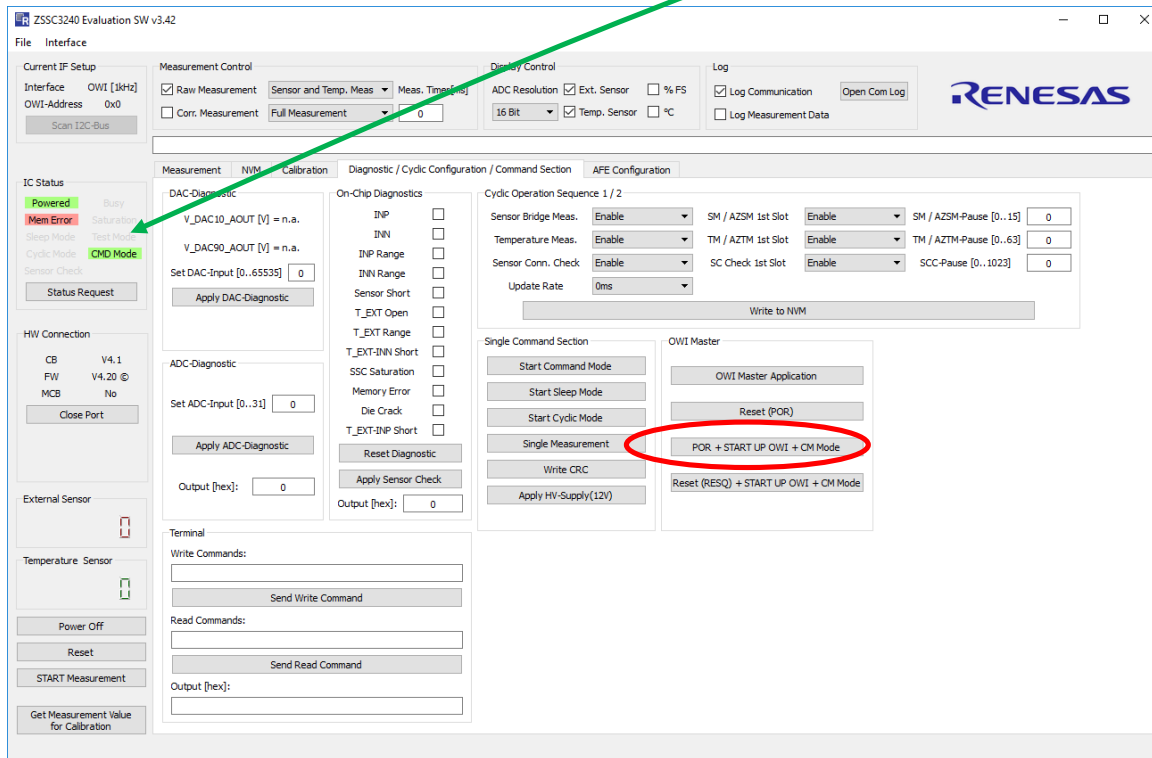

Communication Log:

...
 send_cmd: 'OWT00001D2' response: 'ACK', (STARTUP OWI)
 send_cmd: 'OW_00001A9' response: 'ACK', (ENTER COMMAND MODE)
 receive_owi: 'OR_00001' response: 'ACK', '44', (READ 1 byte -> IC-status)
 ...



⇒ In Command Mode any digital interaction via OWI is applicable: NVM Reading / NVM Writing / Measuring

MEASUREMENT VIA OWI

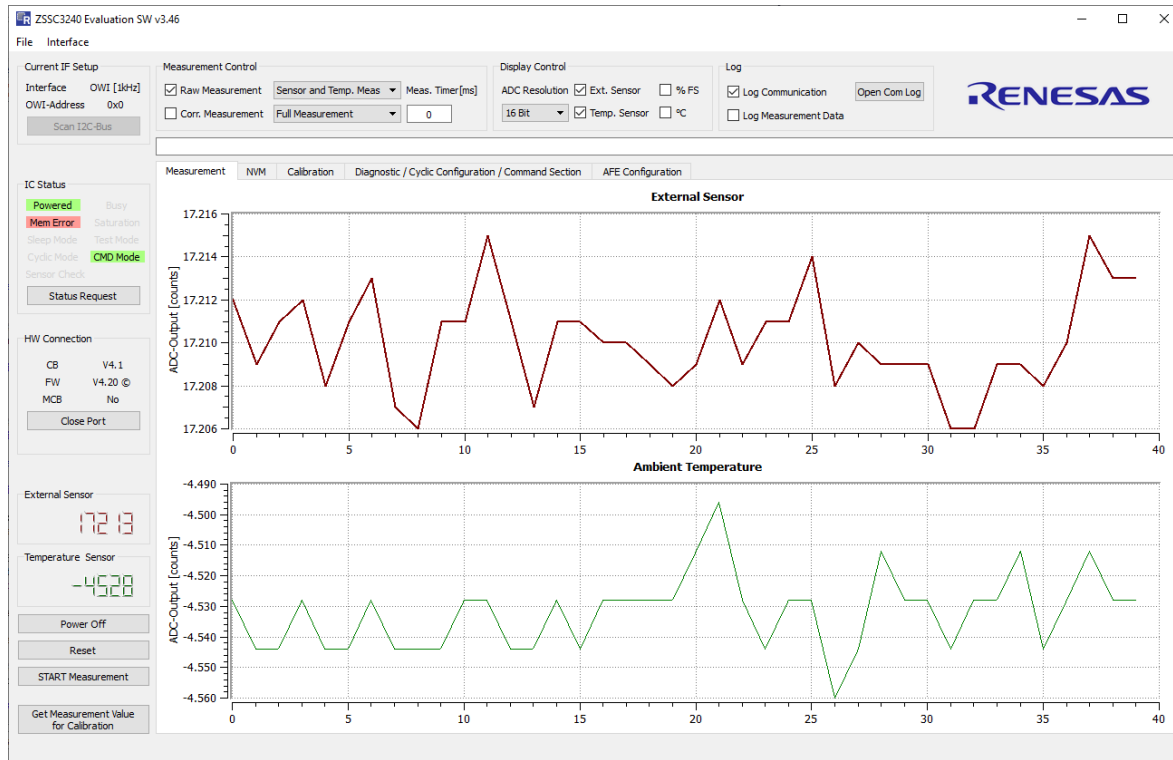

Consistency check, digital vs. analog output:

Measured Loop-Current at given SRB position: **15.8mA**

$$17213 \text{ LSBs} + 32768 \text{ LSBS} = 49981 \text{ LSBs}$$

$$49959 \text{ LSBs} \div 65536 \text{ LSBs} = 0.763 \% \text{ FSO}$$

$$0.763 \% \text{ FSO} \times 20\text{mA} = \mathbf{15.3\text{mA}} \Rightarrow \text{OK, small offset due to DAC deviation}$$

Commnication Log:

```
...
send_owi: 'OW_00001A2' response: 'ACK', ''
receive_owi: 'OR_00004' response: 'ACK', '44433D00'
send_owi: 'OW_00001A4' response: 'ACK', ''
receive_owi: 'OR_00004' response: 'ACK', '44EE5000'
...
```

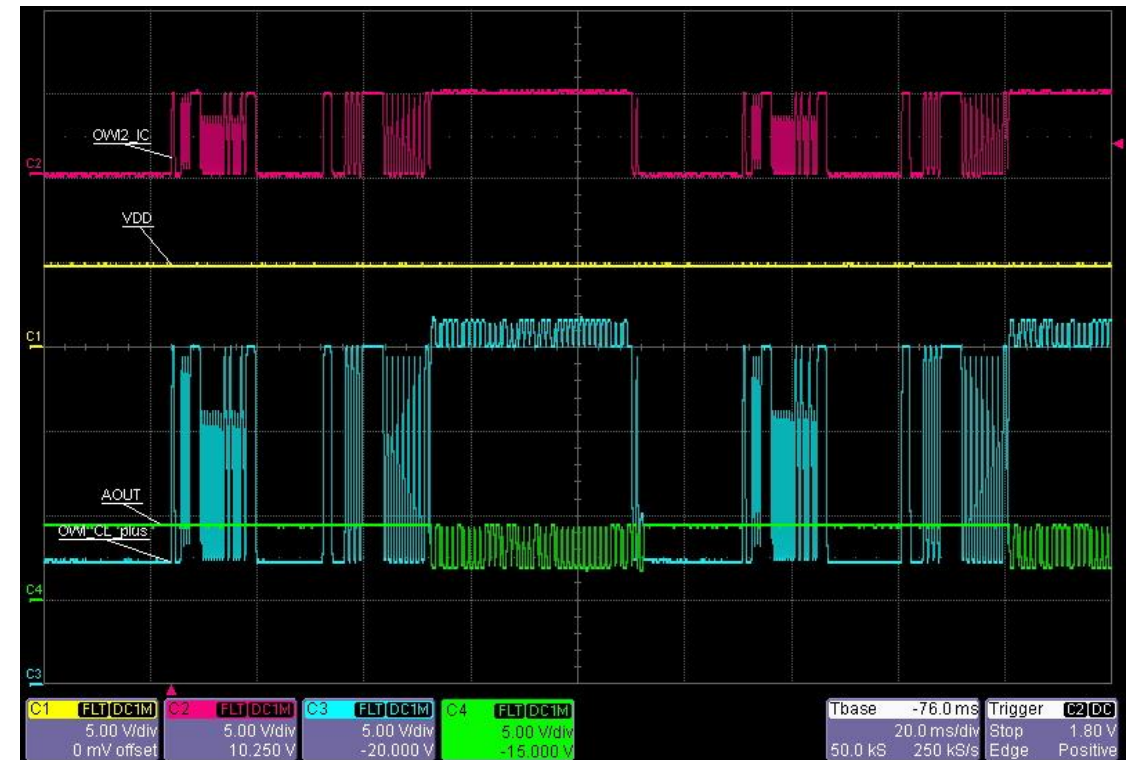

ENTERING CYCLIC MODE FROM COMMAND MODE

HV power supply is controlled by the KS5V signal on the CB. Toggling it causes a POR (power-on reset).

- ⇒ After the POR, the ZSSC3240 is restarting in the programmed default mode (here: Cycling Mode).
- ⇒ Sensor measurement results are provided at AOUT pin such that the Current Loop is driven by the sensor output

Communication Log (POR):

```
...
send_cmd: 'PS_A50' response: 'ACK', "
send_cmd: 'WAIT100' response: 'ACK', "
send_cmd: 'PS_A51' response: 'ACK', "
...
```

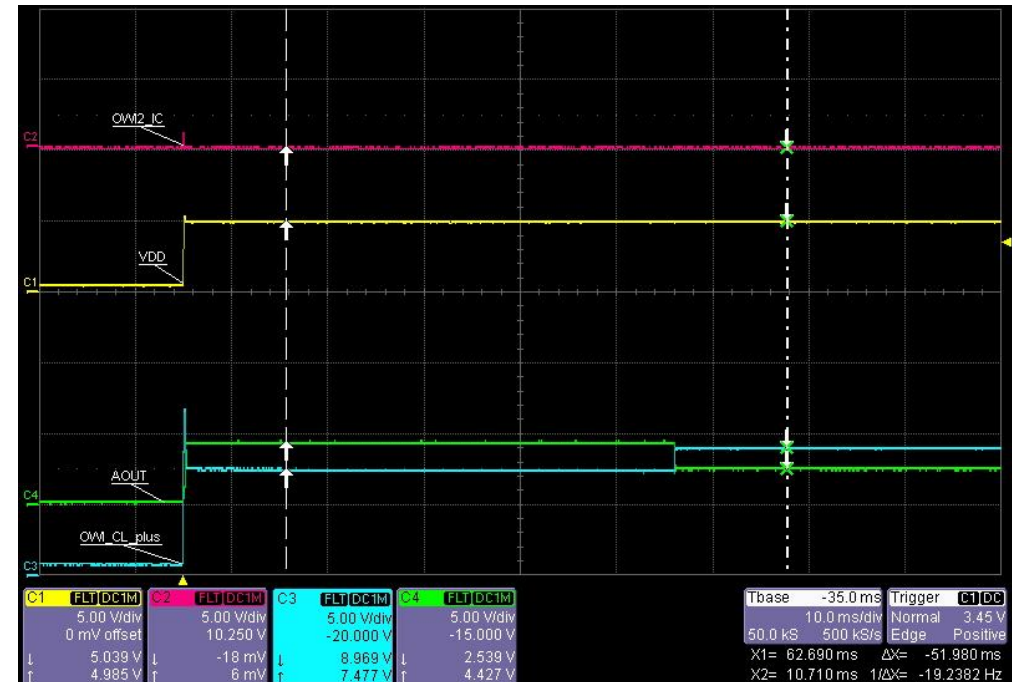
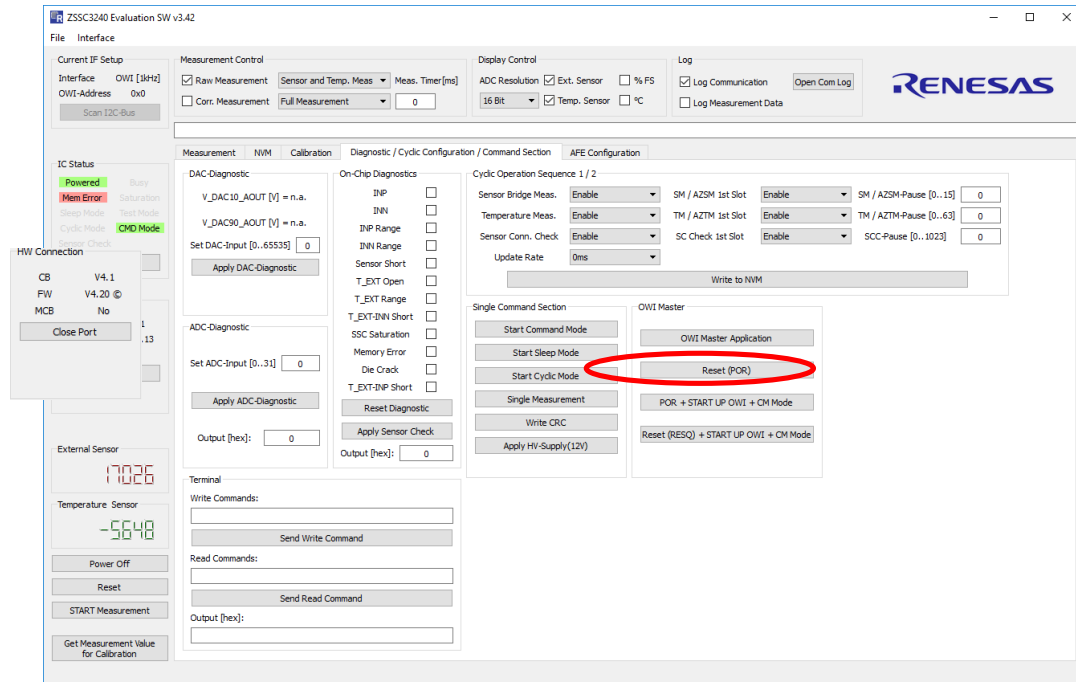

ZSSC3240 CURRENT LOOP CHARACTERISTIC

DAC Current-Loop Output

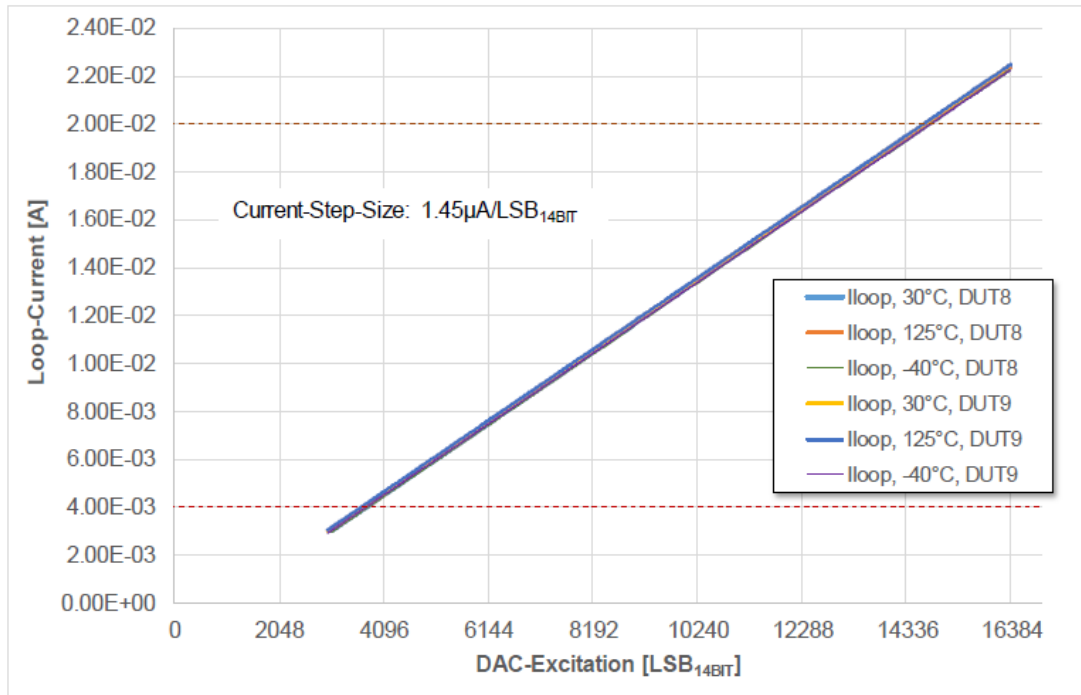

Corresponding Voltage at AOUT-pin

