

Features

- Free positioning TX-A6 3xCoil Charging system
- Wireless Charging active area – 1200mm²
- WPC compatibility
- Foreign Object Detection (FOD) and indication
- Input voltage range - 11.5V~15V
- Output power - upon the receiver capability up to 5W
- Efficiency - Up to 70%
- Status indication LEDs
- Firmware which enables system monitoring
- Easy programmability by I²C

Evaluation Kit Contents

- IDTP9036-A6-Demo PCB Rev1.0
- IDTP9036-TX-A6 User Guide Rev2.3 – this document
- 12V AC to DC Power Adapter
- CD containing:
 - IDTP9036-TX-A6 firmware
 - Reference schematic in Orcad
 - Reference layout Cadence Allegro board files
 - Electronic copy of IDTP9036-TX-A6 UG Rev2.3 – this document

General Description

The IDTP9036-TX-A6 evaluation board serves to demonstrate the features and performance of the IDTP9036 Wireless Power Charging solution for Base Stations with a TX-A6 Coil Transmitter. The three coil transmitter system enables a large active power area with high efficiency transfer and enables power to only one coil at a time when the Receiver is detected. The board provides numerous test points to allow detail signal inspection access at different nodes of the circuit to better understand the key functionality of the system.

The evaluation module is a stand-alone application; all it needs is a 12V/1A DC power adapter and a WPC certified power receiver.

Optionally the EVM's activity can be monitored by I²C communication and GUI (graphical user interface) software through a USB cabled programmer JM60 dongle board, which interfaces the EVM to the computer. The MAIN tab of the software tool provides real time plots of Coil Current, PWM Frequency, and Duty Cycle including different states of the microcontroller and FOD (foreign object detection).

The evaluation board utilizes an external EEPROM which contains Tx firmware to enable programmability. The external EEPROM memory chip is pre-programmed with a standard start-up program that is automatically loaded when 12V power is applied. The EEPROM can be reprogrammed to suit the needs of a specific application using the IDTP9036 software tool.

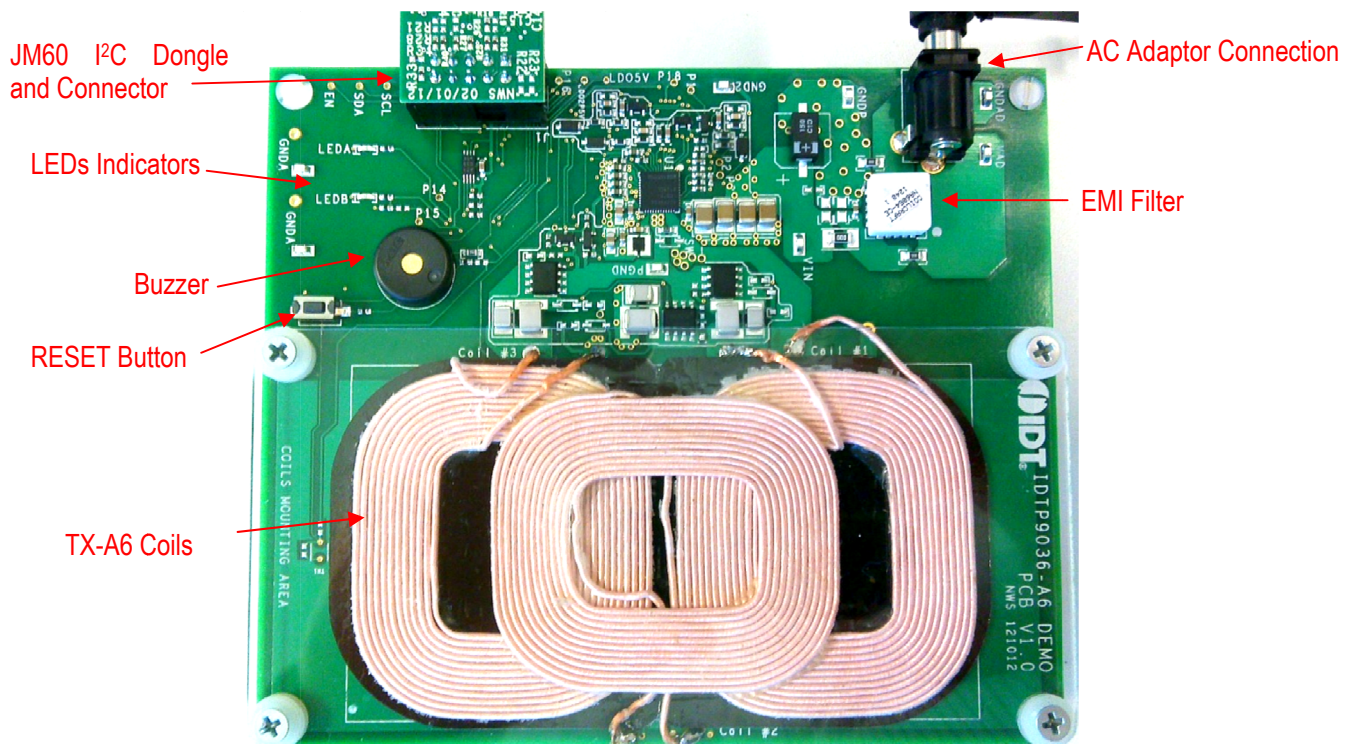

Figure 1 – IDTP9036-EVAL-TX-A6 Overview

Table of Contents

1. EVM Hardware	3	2.2. Typical efficiency curves	13
1.1. Input Power Connection.....	3	3. I ² C INTERFACE ADAPTER AND GUI	14
1.2. EEPROM Programmer Connection	3	3.1. Installation guide	14
1.3. Testing points.....	3	3.2. Verifying Connectivity	15
1.4. LEDs Indication.....	3	3.3. Installing the Windows GUI.....	17
1.5. External Temperature sensing	5	3.4. Writing to the EEPROM.....	18
1.6. EVM Schematic	6	3.5. Troubleshooting	19
1.7. Bill of materials.....	7	4. ORDERING GUIDE.....	23
1.8. PCB Layout Guidelines.....	7	5. IMPORTANT NOTES	23
2. PERFORMANCE MEASUREMENTS.....	13		
2.1. Output power capability	13		

Revision History

June 10, 2012 Version V1.0. Initial release.

June 27, 2012 Version V1.1. Update the board to Rev2.0, Add C25 Reset capacitor from pin 11 to LDO5_OUT. Add R74 and R75 pulldown resistors to GPIO5 and GPIO6.

July 13, 2012 Version V1.2. Correct ordering part number. Add updated E&E coil part number to BOM.

August 15, 2012 Version V2.0. New schematic and board layout added. Add TDK coil part number to BOM.

October 11, 2012 Version V2.1. Update to IDTP9036.

October 12, 2012 Version V2.2. New revision V1.0 PCB/Schematic with IDTP9036.

October 30, 2012 Version V2.3. Add D21 populated with DFLS130L.

November 14, 2012 Version V2.4. Update the schematic with correct center coil connection and resonant capacitor values.

February 1, 2013 Version V2.5. Windows GUI waveforms are disabled..

1. EVM Hardware

1.1. Input Power Connection

A 12V/1A wall adapter plugged into J3 connector may be used to supply the EVM board, but for measurements, the SMD testing points VIN and GND next to J3 can be used to connect to a lab bench power supply



Figure 2 – AC Adaptor input jack.

1.2. EEPROM Programmer Connection

Using the I²C adapter is optional and the main purpose is to upload the firmware into the EEPROM (U3). Also the I²C adapter may be used to interface the IDTP9036 and the PC GUI – see detailed description on “I²C INTERFACE ADAPTER AND GUI” section

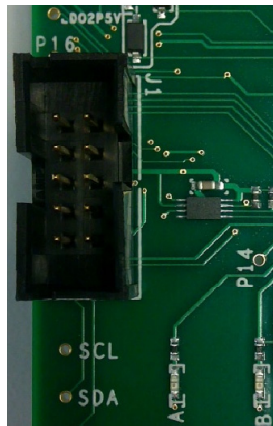

Figure 3 – Keyed JM60 Programmer input 10pin header.

1.3. Testing points

There are two types of test points as shown below: SDA, SCL, EN are through hole for probe tips and SMD clip types which may be used for connecting a probe ground lead or probe clip.

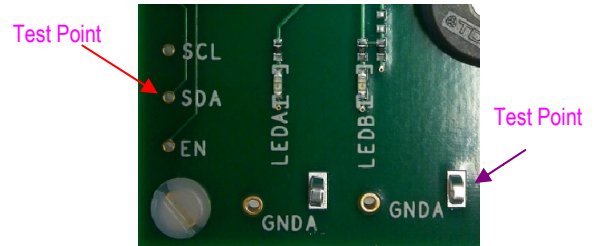

Figure 4 – Surface mount test points.

1.4. LED and Buzzer Indicators

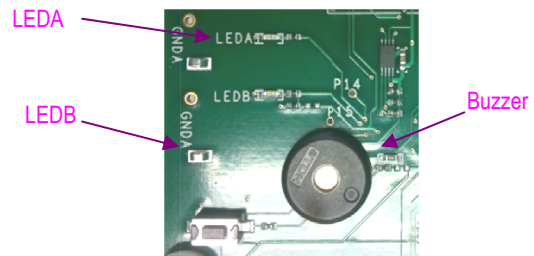

Figure 5 – LED indicators and buzzer connected to GPIOs.

LED FUNCTIONS

Two GPIOs are used to drive LEDs which indicate, through various on/off and illumination options, the state of charging and some possible fault conditions.

A red LED indicates various Fault and FOD (“Foreign Object Detection”) states. The green LED indicates Power Transfer and Charge Complete state information. Upon power up, the two LEDs together may optionally indicate the Standby State and remain in this state until another of the defined Operational States occurs

As shown in Figure 6, one or two resistors configure the defined LED option combinations. The DC voltage set in this way is read one time during power-on to determine the LED configuration. As not to interfere with the LED operation, the useful voltage range for the DC optioning value must be limited to not greater than 1Vdc.

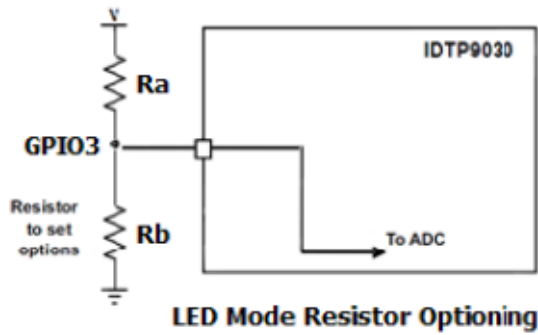

Figure 6. IDTP9036 LED Resistor Options.

Upon power-up, the two LEDs reflect the Standby State and remain in this state until another of the defined Operational States occurs.

There are 10 valid LED option combinations which are selected through the use of two 1% resistors that create a resistor divider value that are read from the GPIOs – two of the LED options are achieved through pull down or pull up (no resistors required). The LED configuration options are detailed in the Table 11.

LED Pattern Operational Status Definitions:

Blink Slow: 1s ON, 1s OFF, repeat

Blink Fast: 400ms ON, 800ms OFF, 400ms ON, 800ms OFF, repeat

The red FOD warning LED is synchronized with the buzzer (if implemented) such that a 400ms tone corresponds with FOD red LED illumination and 800ms off (no sound) corresponds with LED being off. During the 30s that the buzzer is off/silenced, the FOD LED must continue to blink.

Table 1 – IDTP9036 LED Resistor Optioning (Not all options supported, shaded rows are for future development).

LED Control Option	LED Select Resistor Value	Description	LED #/ Color	Operational Status				FOD Warning
				Standby	Power Transfer	Charge Complete	Fault Condition	
1	Pull Down	Standby LEDs ON	LED1- Green	ON	BLINK SLOW	ON	OFF	OFF
			LED2- Red	ON	OFF	OFF	ON	BLINK FAST
2	R1	Standby LEDs ON plus	LED1- Green	ON	BLINK SLOW	ON	OFF	OFF
			LED2- Red	ON	OFF	OFF	ON	BLINK FAST
3	R2	Standby LEDs ON plus	LED1- Green	ON	BLINK SLOW	ON	OFF	OFF
			LED2- Red	ON	OFF	OFF	ON	BLINK FAST
4	R3	Standby LEDs ON plus	LED1- Green	ON	BLINK SLOW	ON	OFF	OFF
			LED2- Red	ON	OFF	OFF	ON	BLINK FAST
5	R4	Standby LEDs ON plus	LED1- Green	ON	BLINK SLOW	ON	OFF	OFF
			LED2- Red	ON	OFF	OFF	ON	BLINK FAST
6	Pull Up	Standby LEDs OFF	LED1- Green	OFF	BLINK SLOW	ON	OFF	OFF
			LED2- Red	OFF	OFF	OFF	ON	BLINK FAST
7	R5	Standby LEDs OFF plus	LED1- Green	OFF	BLINK SLOW	ON	OFF	OFF
			LED2- Red	OFF	OFF	OFF	ON	BLINK FAST
8	R6	Standby LEDs OFF plus	LED1- Green	OFF	BLINK SLOW	ON	OFF	OFF
			LED2- Red	OFF	OFF	OFF	ON	BLINK FAST
9	R7	Standby LEDs OFF plus	LED1- Green	OFF	BLINK SLOW	ON	OFF	OFF
			LED2- Red	OFF	OFF	OFF	ON	BLINK FAST
10	R8	Standby LEDs OFF plus	LED1- Green	OFF	BLINK SLOW	ON	OFF	OFF
			LED2- Red	OFF	OFF	OFF	ON	BLINK FAST

R1-R8 are created using combination of two 1% resistors.

Shaded Area Designates Future Option

Buzzer Function

An optional buzzer feature is supported on GPIO4. The default configuration is an “AC” buzzer. The signal is created by toggling GPIO4 active-high/active-low at a 2KHz frequency.

Buzzer Action: Power Transfer Indication

The IDTP9036 supports audible notification when the device operation successfully reaches the Power Transfer state. The duration of the power transfer indication sound is 400ms.

The latency between reaching the Power Transfer state and the actual buzzer sounding does not exceed 500ms. Additionally, the buzzer sound is concurrent within $\pm 250\text{ms}$ of any change to the LED configuration indicating the start of power transfer.

Buzzer Action: No Power Transfer due to Foreign Object Detected (FOD)

When a major FOD case is detected such that for safety reasons, power transfer is not initiated, or that power transfer is terminated, the buzzer is sounded in a repeating sequence:

For 30 seconds: 400ms ON, 800ms OFF, 400ms ON, 800ms OFF, repeat

Next 30 seconds: Off/silence (but no change to LED on/off patterns)

The pattern is repeated while the error condition exists

The buzzer is synchronized with the FOD LED such that the 400ms on tone corresponds with the Red LED illumination and 800ms off (no sound) corresponds with Red LED being off.

Decoupling/Bulk Capacitors

As with any high-performance mixed-signal IC, the IDTP9036 must be isolated from the system power supply noise to perform optimally. A decoupling capacitor of $0.1\mu\text{F}$ must be connected between each power supply and the PCB ground plane as close to these pins as possible. For optimum device performance, the decoupling capacitor must be mounted on the component side of the PCB. Avoid the use of vias in the decoupling circuit. Additionally, medium value capacitors in the $22\mu\text{F}$ range must be used at the VIN input to minimize ripple current and voltage droop due to the large current requirements of the resonant half Half-Bridge driver. At least four $22\mu\text{F}$ capacitors must be used close to the IN pins of the device. Since the operating voltage is 12V, the capacitance value of the capacitors will decrease due to voltage derating characteristics. For example, a $22\mu\text{F}$ X7R 25V capacitor's value is actually $10\mu\text{F}$ when operating at 12V.

There must also be a low ESR $82\mu\text{F}$ to $100\mu\text{F}$ bulk capacitor connected at the node where the input voltage is applied to the board. A 16V POSCON-type or aluminum electrolytic must be connected between the input supply and ground as shown in Figure 8. POSCON capacitors have much lower ESR than aluminum electrolytic capacitors and will reduce voltage ripple.

1.5. External Temperature sensing

The firmware will support external temperature sensing using the circuit shown below. See the IDTP9036 Data Sheet Application Information section about the external temperature sensing (coil temperature) using a 10K thermistor.

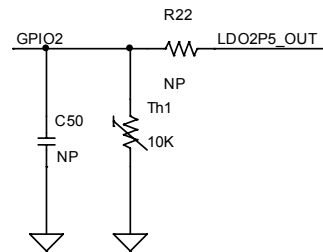

Figure 6 – IDTP9036 GPIO2 connection to external thermistor..

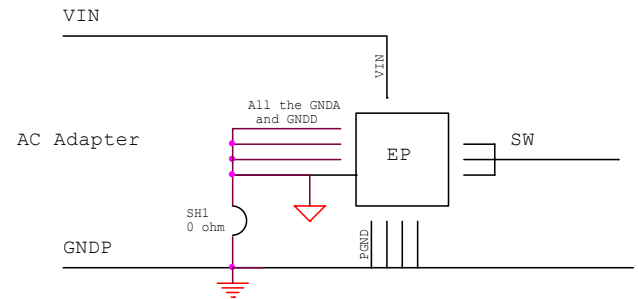

Figure 7. EVM Application Schematic: Grounding scheme

1.6. EVM Schematic

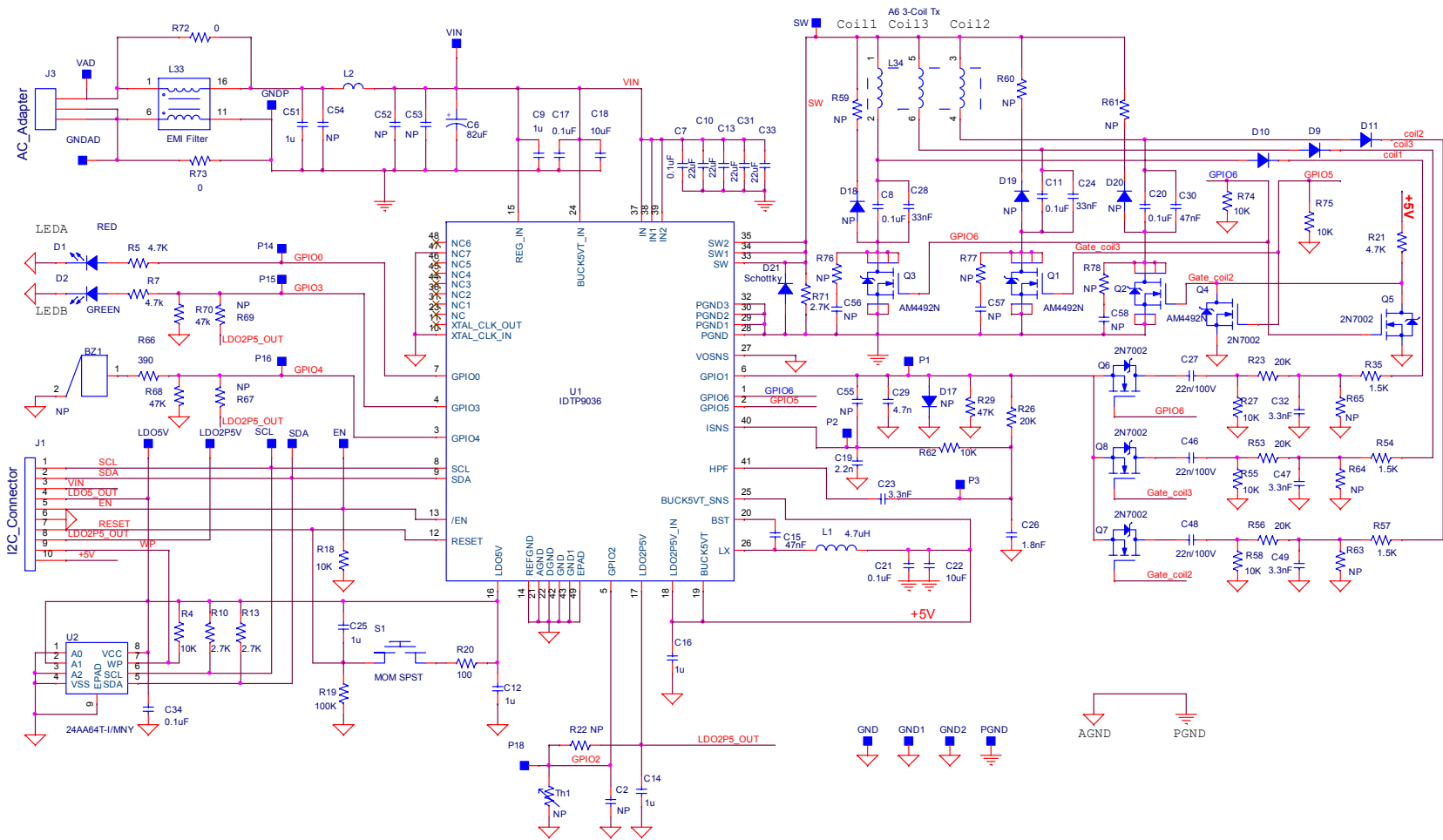

Figure 8 - EVM Application Schematic: Main schematic

1.7. Table 2 - Bill of materials

Item	Quantity	Reference	Part	Manufacturer	Part Number	PCB Footprint
1	1	BZ1	BUZZER PIEZO 4KHZ	TDK	PS1240P02CT3	12.2MM PC MNT
2	5	C2,R22,C55,R67,R69	NP		NP	402
3	1	C6	100uF	Panasonic/Sanyo	16TQC100MYF	POSCON_D3
4	4	C7,C17,C21,C34	CAP CER 0.1UF 50V 10% X7R	Murata	GRM188R71H104KA93D	603
5	3	C8,C11,C20	CAP CER 0.1UF 100V 5% NPO	TDK Note 1	C4532C0G2A104J	1812
6	6	C9,C12,C14,C16,C25,C51	CAP CER 1UF 35V 10% X5R	Taiyo Yuden	GMK107BJ105KA-T	603
7	4	C10,C13,C31,C33	CAP CER 22UF 25V 10% X7R	Murata	GRM32ER71E226KE15L	1210
8	1	C15	CAP CER 0.047UF 16V 10% X7R	Murata	GRM188R71C473KA01D	603
9	1	C18	CAP CER 10UF 25V 20% X5R	TDK	C2012X5R1E106M	805
10	1	C19	CAP CER 2200PF 50V 10% X7R	Taiyo Yuden	UMK105B7222KV-F	402
11	1	C22	CAP CER 10UF 10V 10% X7R	Murata	GRM21BR71A106KE51L	805
12	1	C23	CAP CER 3300PF 50V 10% X7R	Murata	GRM155R71H332KA01D	402
13	1	C24	CAP CER 0.047UF 100V 5% NPO	TDK Note 1	C3225C0G2A473J	1210
14	1	C26	CAP CER 1800PF 50V 10% X7R	Murata	GRM155R71H182KA01D	402
15	3	C27,C46,C48	CAP CER 0.022UF 100V X7R	TDK Note 1	C1608X7R2A223K	603
16	2	C28,C30	CAP CER 0.033UF 100V 5% NPO	TDK Note 1	C3225C0G2A333J	1210
17	1	C29	CAP CER 4700PF 100V 10% X7S	TDK Note 1	C1005X7S2A472K	402
18	3	C32,C47,C49	CAP CER 1200PF 100V 5% NPO	TDK Note 1	C1608C0G2A122J	603
19	4	C52,R63,R64,R65	NP		NP	603
20	2	C53,C54	NP		NP	805
21	1	D1	LED SMARTLED 630NM RED	Osram	L29K-G1J2-1-0-2-R18-Z	0603_DIODE
22	1	D2	LED SMARTLED GREEN 570NM	Osram	LG L29K-G2J1-24-Z	0603_DIODE
23	3	D9,D10,D11	DIODE SWITCH 200V 250MW	Diodes Inc.	BAV21W-7-F	SOD123
24	1	D17	NP		NP	0402_diode
25	4	D18,D19,D20	NP		NP	SOD123
26	1	D21	1.0A SCHOTTKY BARRIER RECTIFIER	Diodes Inc.	DFLS130L	PowerDI123
27	13	P1,P2,P3,LDO5V,P14,P15,P16,P18,LDO2P5V,SW,SDA,SCL,EN	VC6		NP	TEST_PT30DPAD
28	7	GND1,VIN,VAD,PGND,GNDP,GNDAD,GND	VC6	Keystone	5015	TEST_PT_SM_135X70
29	1	J1	CONN HEADER LOPRO STR 10POS GOLD	TE Connectivity	5103308-1	CON10
30	1	J3	CONN POWER JACK 2.1X5.5MM HI CUR	CUI Inc.	PJ-002AH	JACK_5MM
31	1	L1	4.7uH 10% 580mA	Coilcraft	XPL2010-472ME	IND_2SQ_TO_3P3REC
32	1	L2	Short	Short	Short	1806
33	1	L33	EMI Filter	Coilcraft	NA6054-CE	clcft_na6054
34	1	L34	WPC A6 3-Coil Tx	TDK E&E	WT-1005660-12K2-A6-G Y31-60054F	3coil_A6_WPC standard
35	3	Q1,Q2,Q3	N-Channel 100-V (D-S) MOSFET	Analog Power	AM4492N	SOIC8
36	5	Q4,Q5,Q6,Q7,Q8	MOSFET N-CHAN DUAL 60V SOT363	Fairchild	2N7002	SOT363
37	5	R4,R18,R62,R74,R75	RES 10.0K OHM 1/16W 1%	Yageo	RC0402FR-0710KL	402
38	3	R5,R7,R21	RES 4.99K OHM 1/10W 1%	Panasonic	ERJ-2RKF4991X	402
39	2	R10,R13	RES 2.7K OHM 1/10W 5%	Panasonic	ERJ-2GEJ272X	402
40	1	R19	RES 100K OHM 1/16W 1%	Yageo	RC0402FR-07100KL	402
41	1	R20	RES 100 OHM 1/16W 1%	Yageo	RC0402FR-07100RL	402
42	3	R23,R53,R56	RES 20.0K OHM 1/10W 1%	Panasonic	ERJ-3EKF2002V	603
43	1	R26	RES 20.0K OHM 1/10W 1%	Panasonic	ERJ-2RKF2002X	402
44	3	R27,R55,R58	RES 10.0K OHM 1/10W 1%	Panasonic	ERJ-3EKF1002V	603
45	3	R29,R68,R70	RES 47K OHM 1/10W 5%	Panasonic	ERJ-2GEJ473X	402
46	3	R35,R54,R57	RES 1.00K OHM 1/10W 1%	Panasonic	ERJ-3EKF1001V	603
47	3	R59,R60,R61	NP	Panasonic	ERJ-3GEYJ330V	603
48	1	R66	RES 390 OHM 1/10W 5%	Panasonic	ERJ-3GEYJ391V	603
49	1	R71	RES 2.7K OHM 1/10W 5%	Panasonic	ERJ-3GEYJ272V	603
50	2	R72,R73	RES 0.0 OHM 1/8W	Panasonic	ERJ-6GEY0R00V	805
51	1	S1	MOM SPST	Wurth	434 121 043 816	we_mom_spst_4341
52	1	Th1	NP		NP	NTC1
53	1	U2	IC EEPROM 64KBIT 400KHZ	Microchip	24AA64T-I/MNY	TDFN8
54	1	U1	12V Wireless Transmitter IC for TX-A6	IDT	IDTP9036	48LD_6X6MM_OP4

Note 1: Recommended capacitor temperature/dielectric and voltage ratings: 100V capacitors are recommended because 100Vp-p voltage transients may appear on the resonance capacitors as stated in the WPC specification. COG/NPO-type capacitor values stay relatively constant with voltage while X7R and X5R ceramic capacitor values de-rate from 40% to over 80%. The decision to use lower voltage 50V capacitors or other type temperature/dielectric capacitors is left to the end user.

1.8. PCB Layout Guidelines

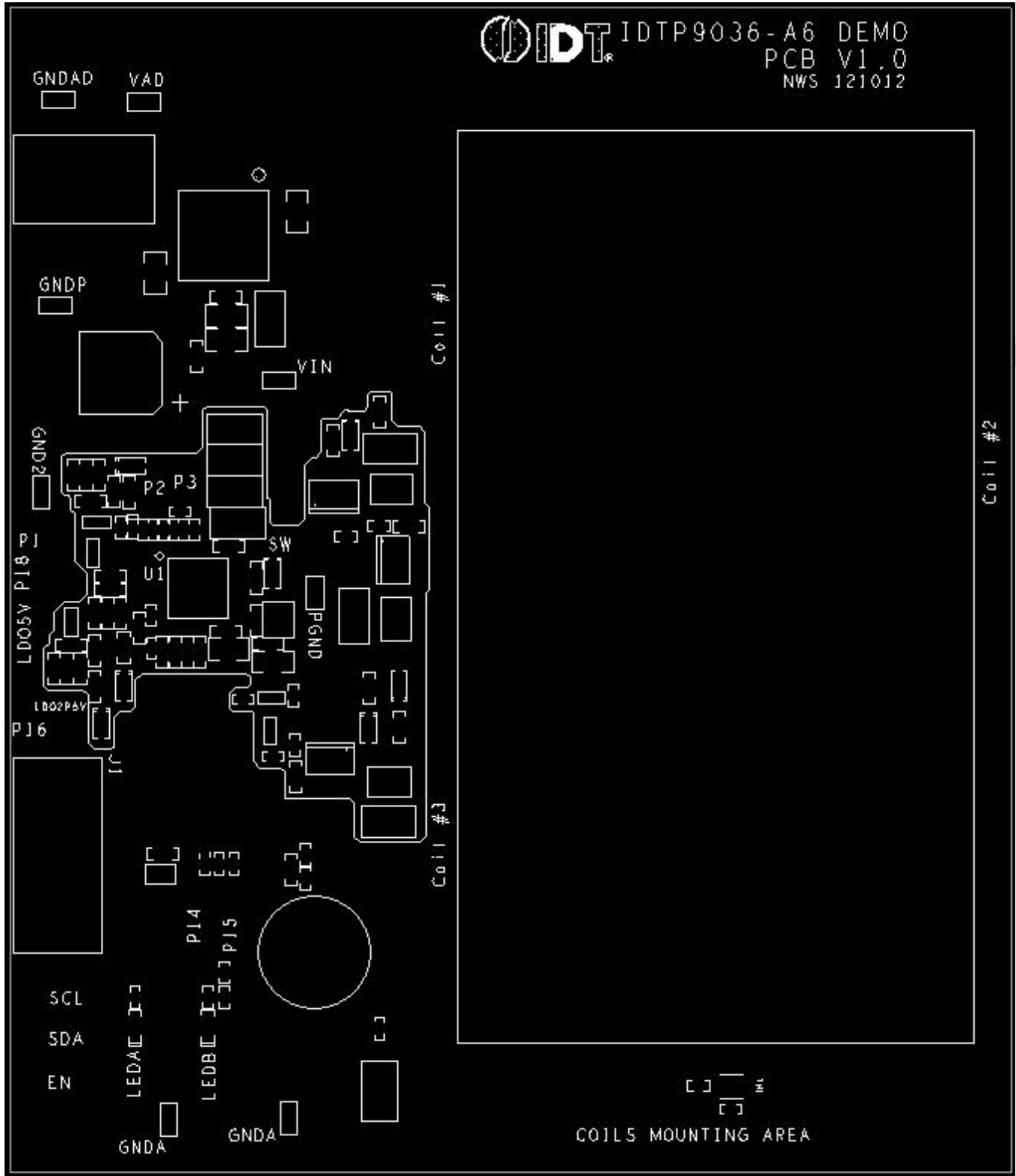

Figure 9 - Component Map

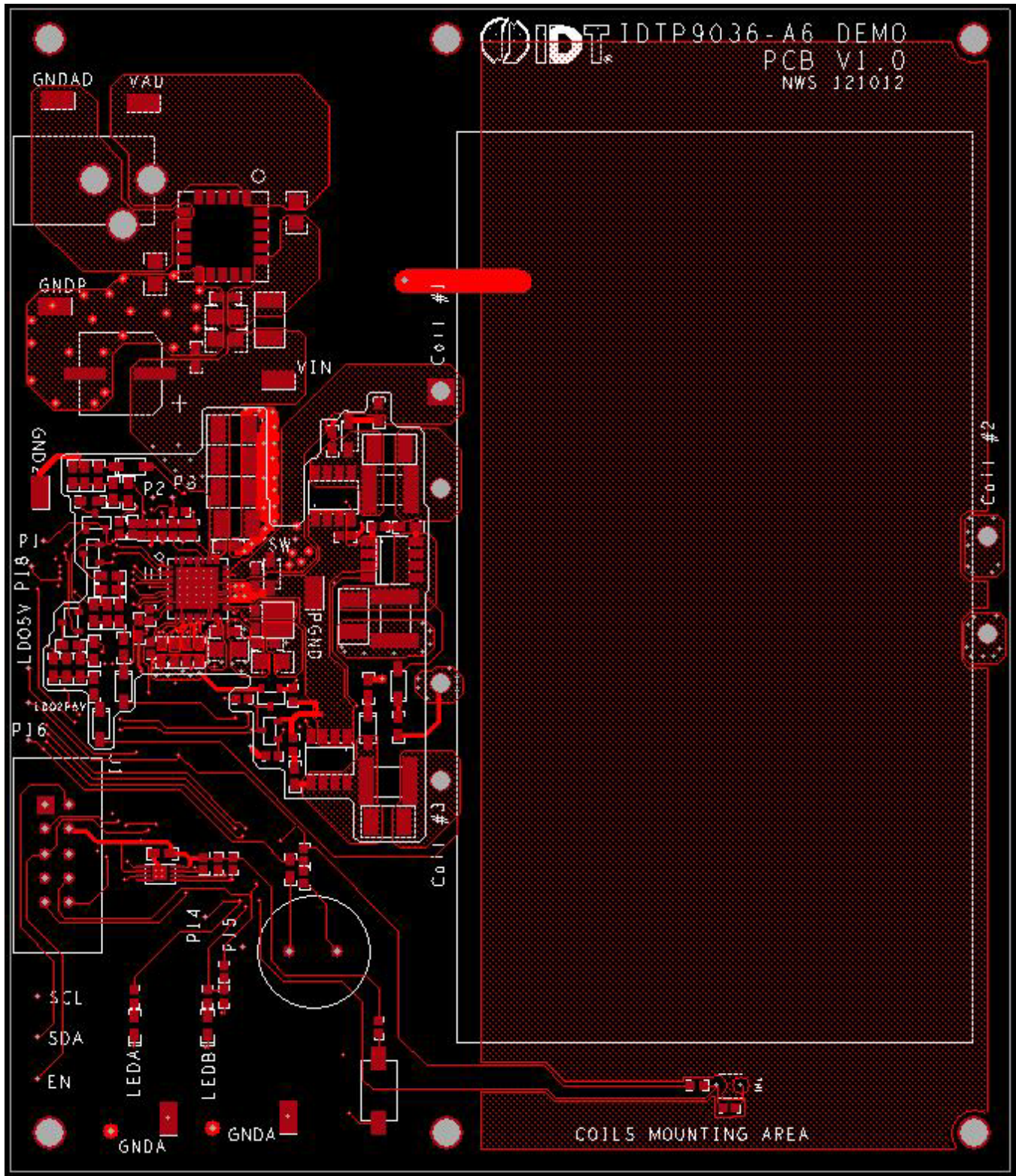

Figure 10 - Top Layer and Top Silkscreen Layer

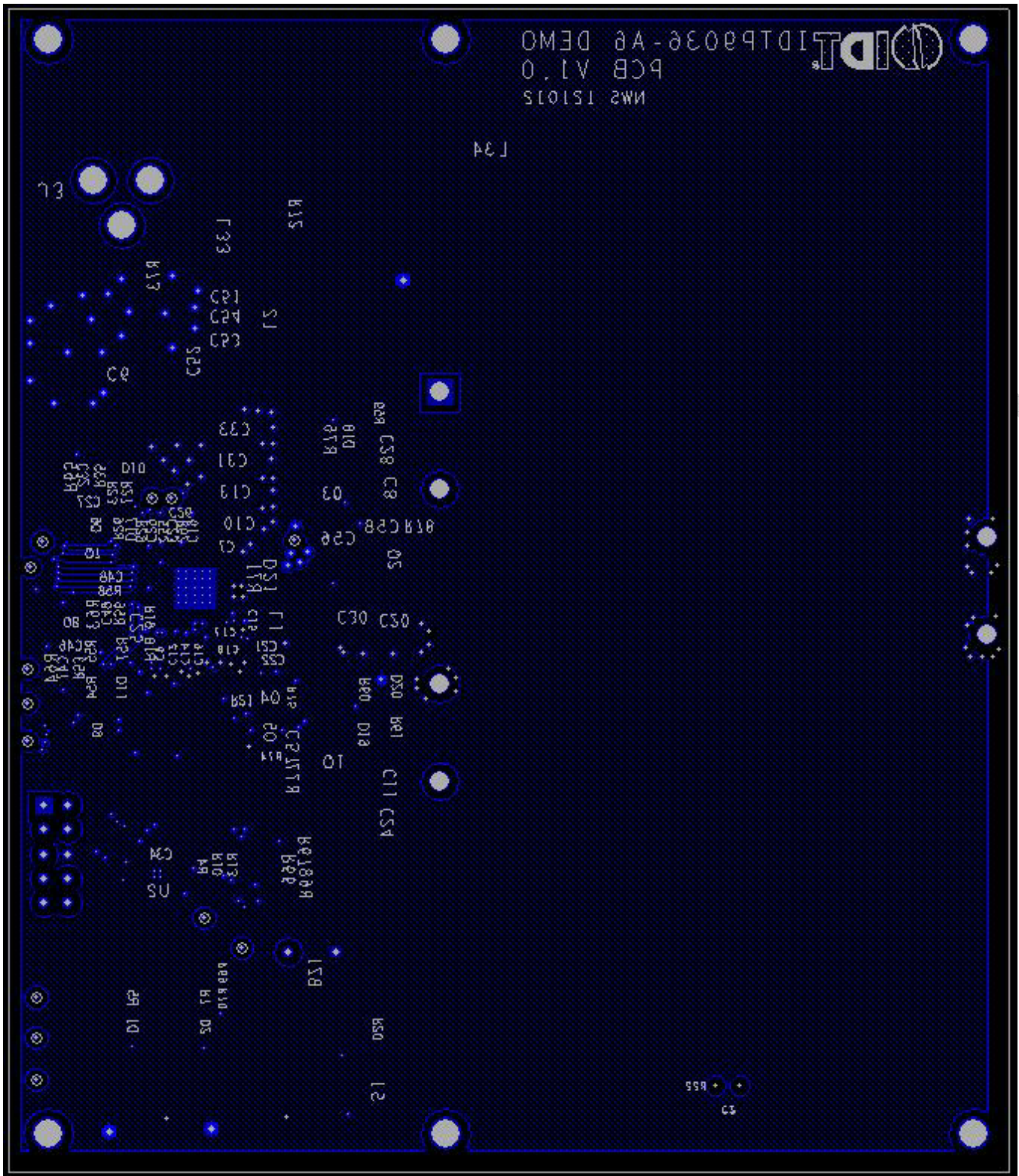

Figure 11 - Bottom Layer and Bottom Silkscreen Layer

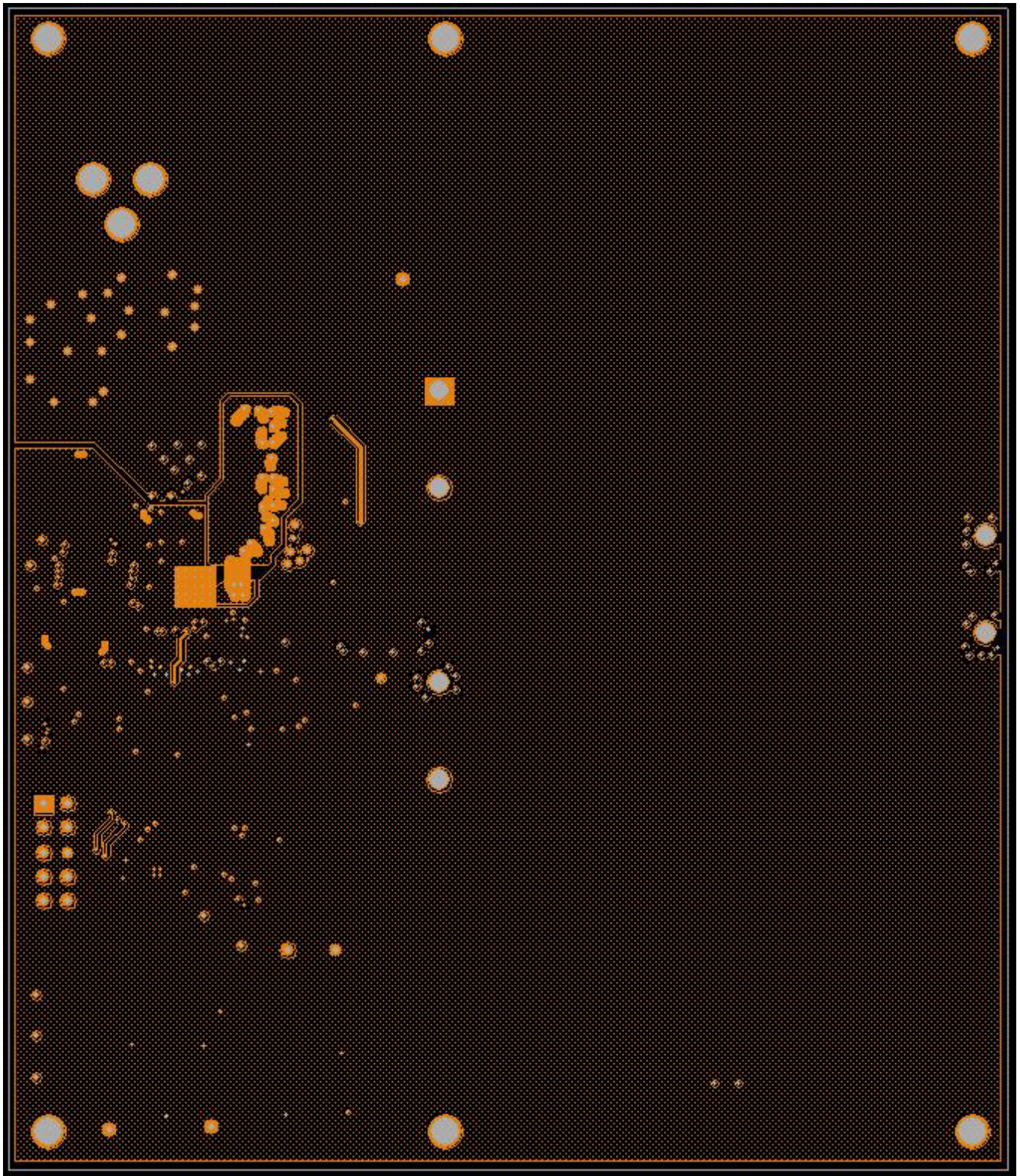

Figure 12 - Mid1 Layer

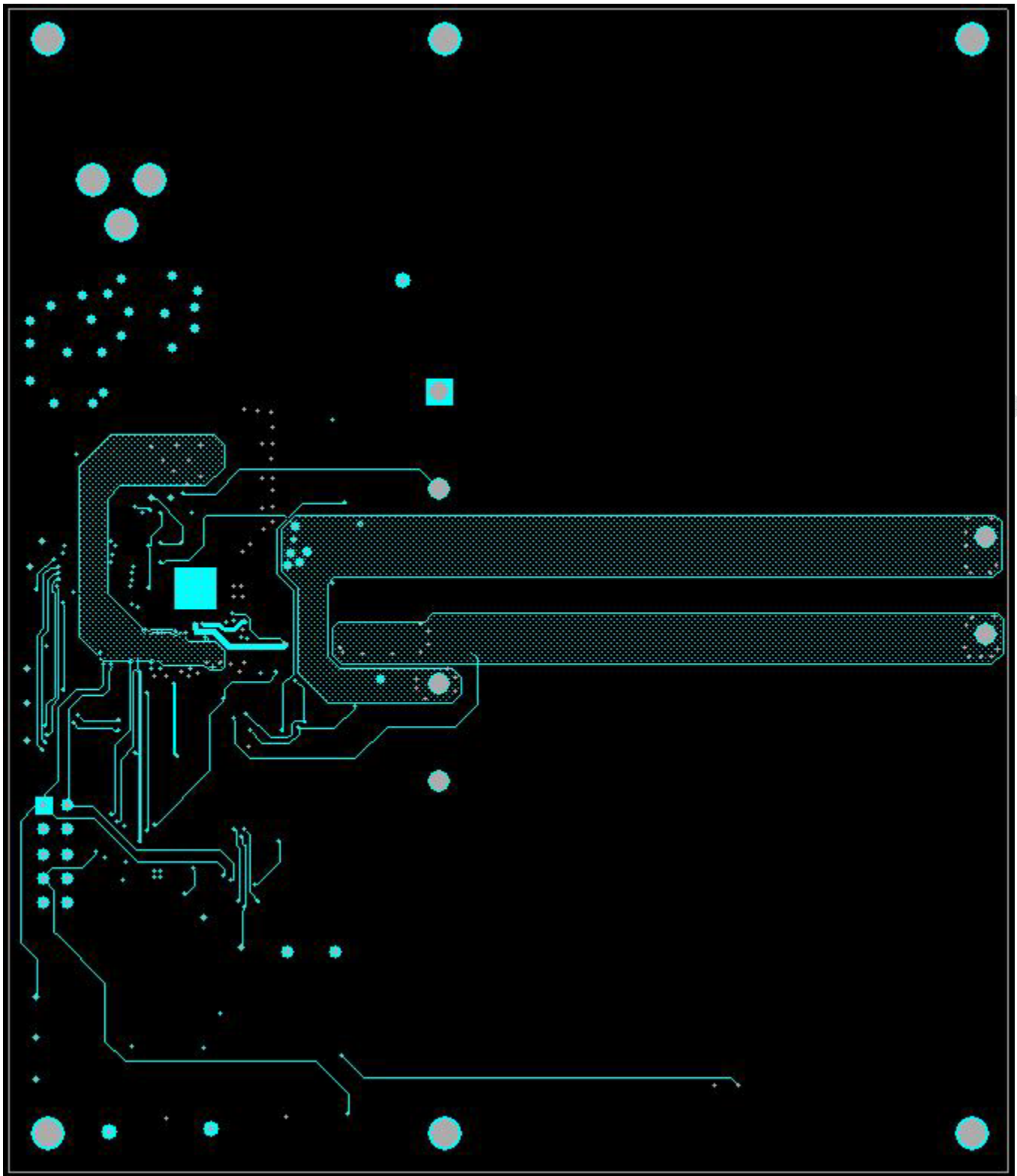

Figure 13 - Mid 2 Layer

2. PERFORMANCE EVALUATION

2.1. IDTP9036 Switching frequency

Use a universal RX module to receive power from the IDTP9036EVM and plot the switching frequency versus load current.

There are various power receiver models found on the market, and the plot may also vary.

Below is an example of a typical frequency characteristic versus varying load requirements.

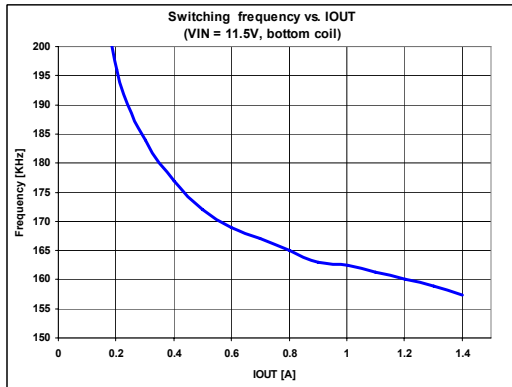

Figure 14 – IDTP9036 Switching frequency versus power.

2.2. Power transfer efficiency

The efficiency is measured by comparing the input power to the output power

$$\eta = \frac{P_{out}}{P_{in}} = \frac{V_{out} \cdot I_{out}}{V_{in} \cdot I_{in}}$$

The chart below shows a typical efficiency characteristic versus load current

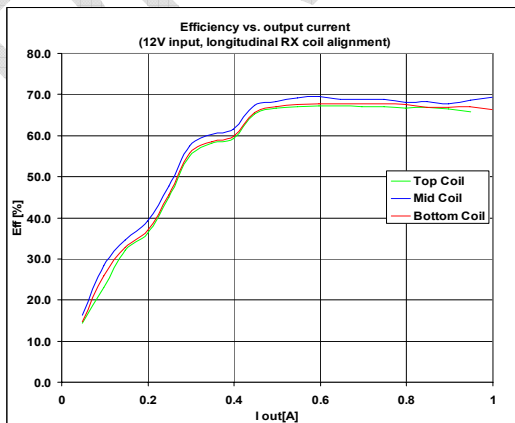

Figure 15 – TX to RX efficiency versus output current.

2.3. Load Transient

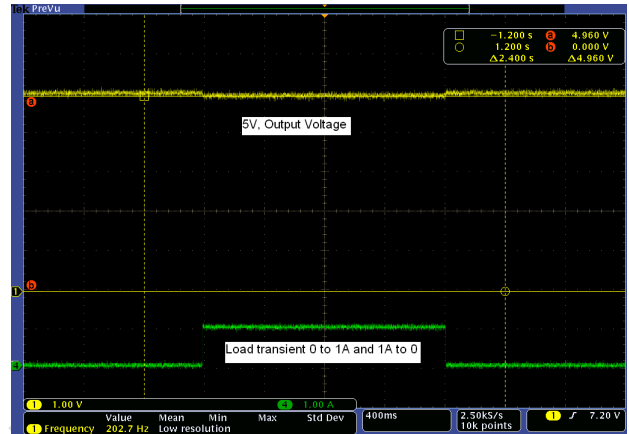

Figure 16 – TX to RX load transient.

2.4. Coil Waveforms

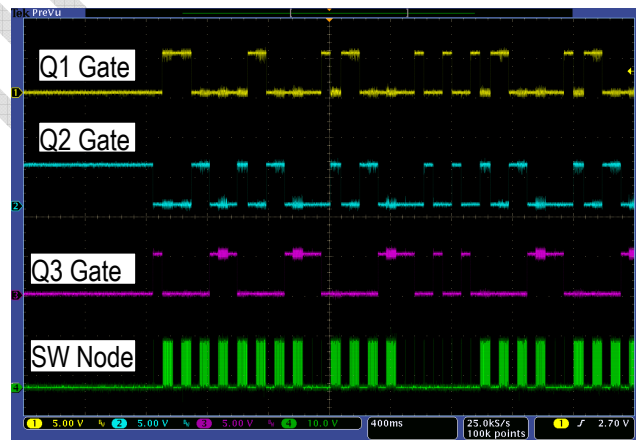

Figure 17 – TX-A6 three coil waveforms during detect mode..

3. I²C INTERFACE ADAPTER AND GUI

This IDTP9036-TX-A6 EVM is designed to demonstrate the performance and functionality of the IDTP9036 wireless transmitter in a lab bench test environment. In most cases, this board can be wired into an existing system for evaluation. For complex or electrically sensitive situations, it is recommended to use the reference layout to integrate this design into the final system to eliminate hardware limitations or signal degradation introduced by long leads.

With no computer interface, this evaluation board can function in its pre-programmed mode of operation using a 12V power supply or AC adaptor. To evaluate the full potential of this device, a PC with USB output is required. Everything you need is included in this evaluation kit.

3.1. Installation guide

Follow these simple steps to power-up and enable the power management features of the IDTP9036:

1. Connect the USB cable from a PC to the 1" x 2" JM60 programming board. The JM60 board has already been programmed at the factory.
2. Connect the JM60 to the connector of the IDTP9036-TX-A6 EVM board (J1 Figure 18).
3. Plug the AC adapter into the wall (120 VAC) and connect the other end (12 VDC) into the adapter plug on the EVM board (J3 Figure 18).
4. Next, install the Wireless Power Demo Windows GUI software by executing the Setup.exe file in the folder "9036Tool_final" (Figure 19).
5. Click Start >> All Programs >> Integrated Device Technology (Folder) >> Wireless Power Demo (Application Icon) to open the GUI for IDTP9036 Wireless Power Transmitter Demo software Fig 20.

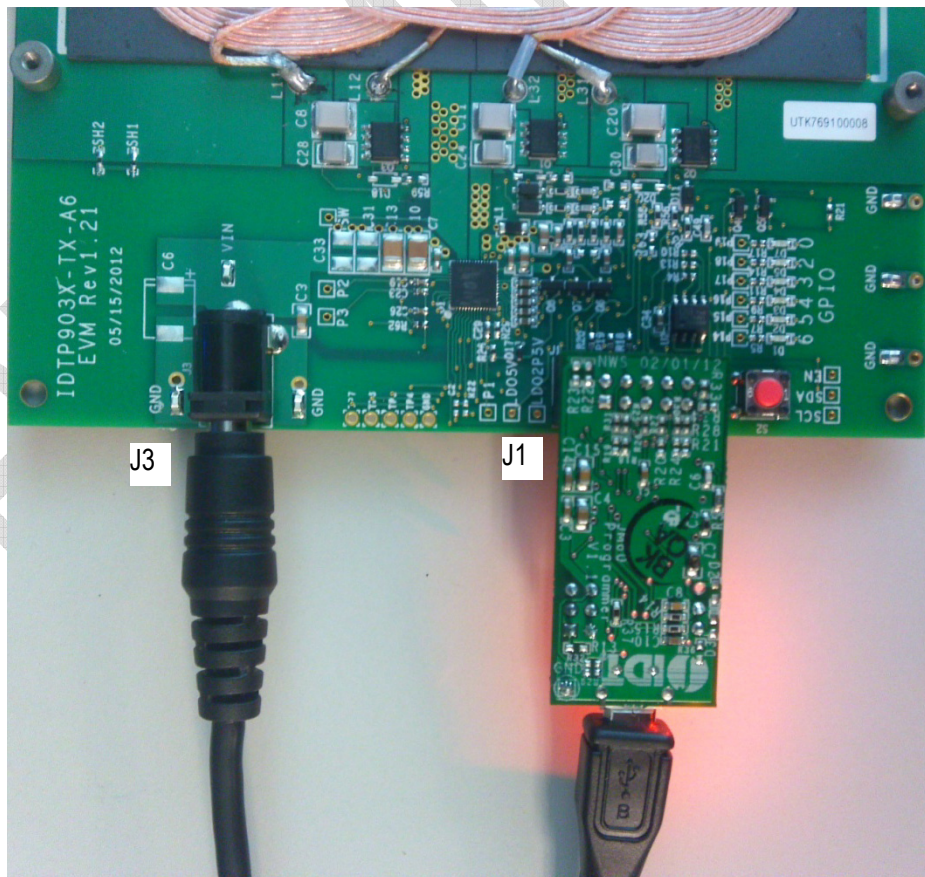

Figure 18. IDTP9036-EVAL JM60, AC Adaptor connections.

6. Without an RX load on the coil, note which LEDs are lit up on the eval board. Now place a load onto the coil and observe the different LEDs that light up depending upon where the RX load is placed onto the coils. The LEDs are defined in Figure 5. Also observe the different real time signals propagating on the GUI (Figure 21). Any problems see Troubleshooting page 19.

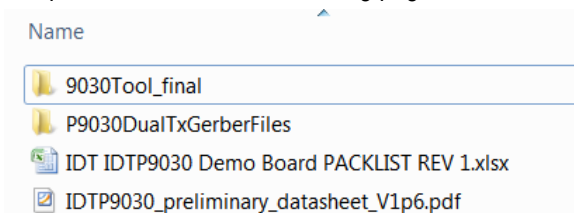

Figure 19. File folder structure on the CDROM.

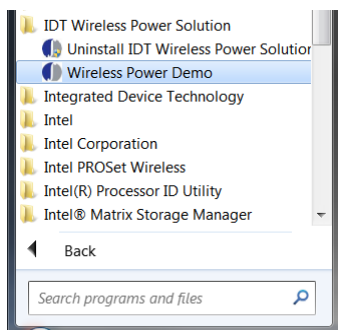

Figure 20. Starting the Graphical User Interface

3.2. Verifying Connectivity

You can verify that the IDTP9036 is properly connected to your computer and able to communicate with the evaluation board by looking at the lower left of Figure 21. It should state “USB Connected”. Otherwise it will state in Red letters: “USB Disconnected – Check Connection”.

If it states **USB Disconnected**, it might be that the driver was not properly installed on the PC. Check that a USB Connector icon appears and disappears, at the lower right of the Windows Taskbar, as the Cable’s USB Connector is plugged and unplugged from the USB port. If it does not appear, then proceed to Troubleshooting section, item 5.

- 1) The MAIN tab of the GUI provides 3 real time signals: PWM Frequency, Coil Current, and Duty Cycle.
- 2) Placing different Rx objects and loads onto the coils will change the real time signals, and it will change the location of the Blue “dot” at the left side of the GUI’s MAIN tab (Figure 21). For example, when the system is first turned-on, and without a load on the coil, the Blue “dot” will flash, i.e, “ping”, at the WPC Ping text location, at the very top left hand side of GUI. Then, when a load is placed on the coil, the flashing Blue “dot” at WPC Ping will cease and a solid Blue dot will appear at the Power Transfer Line text location on the left hand side of the GUI. Also, it should be noted that the red LEDs D3 and D4 will flash on/off on the eval board without an RX. Note, however, that if the load is connected to one of the three coils, the red LEDs will turn on as shown in Figure 5 and Table 1. Also, once the RX has established good communication with the evaluation board, the Rx Detected and Power Transfer “non flashing” solid Blue dots located just below the real time signals on the MAIN tab of the GUI will appear, Figure 21. Moving the RX on the coils will change the Coil Selection LEDs as shown in Table 1.

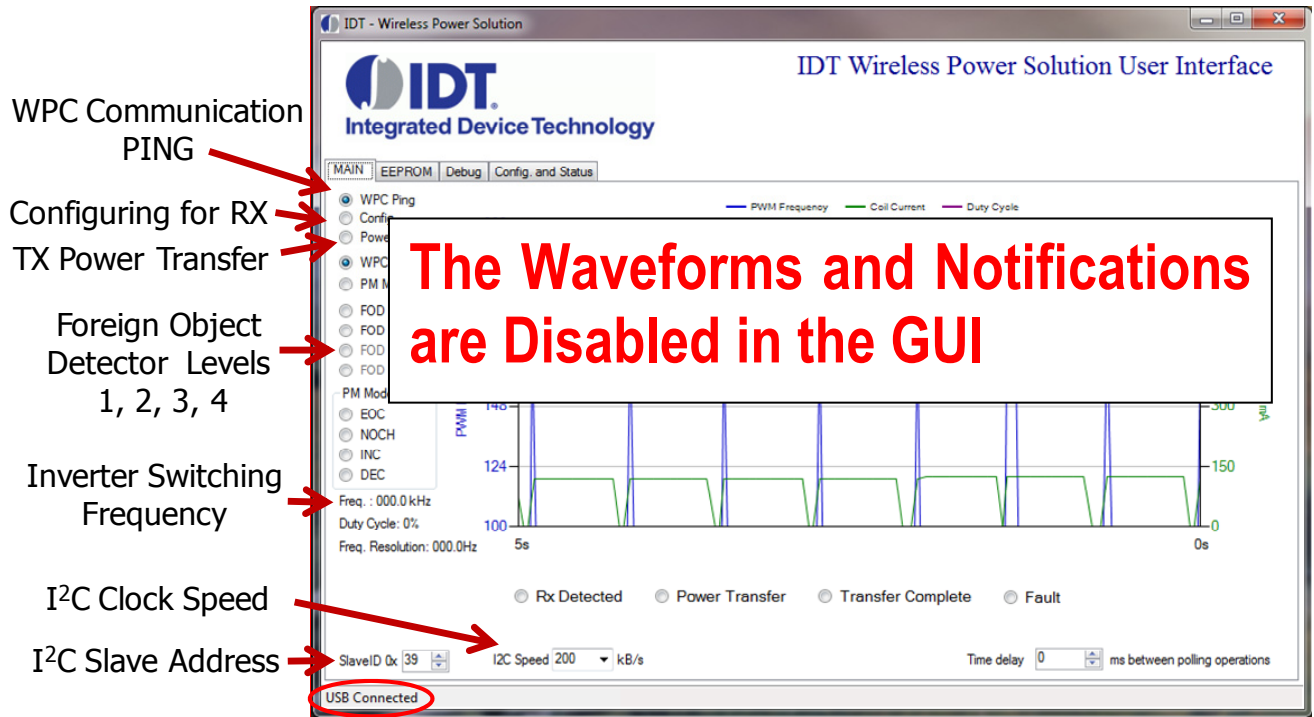

Figure 21. Windows GUI Main tab

3.3. Installing the Windows GUI

For the first time use of the IDTP9036-TX-A6 EVM board or to write a new binary file into the EEPROM, the Windows Drivers and GUI must be installed to communicate with the JM60 USB to I²C controller that is located on the JM60 Programmer Dongle board. The JM60 Dongle board is attached to the left side of the DEMO board, and is connected via a 10pin keyed header on the top side of the board. The purpose of this controller is to be able to write different ".bin" files into the EEPROM on the DEMO board, and to be able to acquire real time signals showing system operation. Different .bin files can be made available, for example, when a different output power setting test is desired.

Example installation of the Windows USB-to I²C-Drivers on a Win7 32-bit or 64-bit system is shown in the following steps:

To install the GUI, open the IDTP9036-DEMO CD and run the file: setup-1.0.0.11.exe within the 9036Tool_final folder. I.e. the path is 9036Tool_final/setup-1.0.0.11.exe shown in figure 19 or 22. Follow the Setup Wizard instruction shown in Figure 23. This will install the GUI and driver automatically. After the installation process is complete, you may connect the evaluation board to the computer with the USB cable, via the Dongle, and use the software tool. *At this point, a little USB icon should appear at the lower right of the desktop screen. If it does not, then the machine being used should be rebooted. Now connect the JM60 dongle board into the evaluation board and then connect the 12V supply. Now plug the USB cable into the dongle board, and plug the USB cable into the PC.*

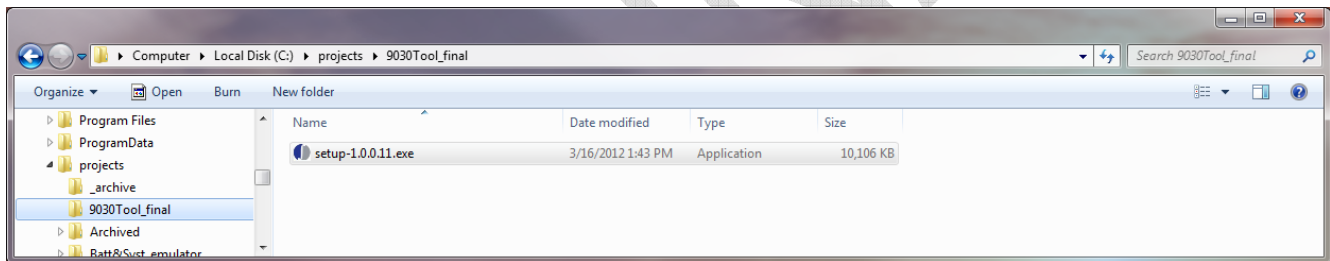

Figure 22. Path to driver setup.exe



Figure 23. Setup Wizard

3.4. Writing to the EEPROM

Loading the .bin File

The EEPROM already comes with a standard BIN file programmed into it, which gets downloaded to the IDTP9036 upon power up. However, if another one has been provided by the factory, the way to write it into the EEPROM is as follows:

- 1) Plug the USB cable from the computer to the dongle's USB type B connector.
- 2) Plug the dongle into the IDTP9036-TX-A6 EVM board. Make sure only a jumper exists on J4 of the dongle in a position closest to the USB connector.
- 3) Plug the 12V power supply into the IDTP9036-TX-A6 EVM Board.
- 4) Click Start >> All Programs >> Integrated Device Technology (Folder) >> Wireless Power Demo.
- 5) Click on the EEPROM tab directly right of the MAIN tab.
- 6) Click on the Load Bin file and browse to the path where the new bin file is located, for example, on the CD (type .bin).
- 7) Referencing Figure 24, click the Reset Target box so it shows a check mark
- 8) Set the EEPROM Slave ID to 52 and select the Scan I2C button (Fig 24 lower right) and check that the slave address for the EEPROM appears as 0x52 and then.
- 9) Click the Write EEPROM button, the green progress bar should increase in size from left to right and two **green passes** should be observed as the file is written to the EEPROM and then the Write OK should appear at the bottom of the screen. If not, click the Write EEPROM button again until Write OK appears.
- 10) Finally, to get the LEDs on the DEMO board to start flashing, the Reset Target check mark has to be unchecked. Uncheck it and the various LEDs will start flashing.

If a Write OK is not shown in step 8, then refer to the Troubleshooting section on page 19. "Error Writing" is what should be shown in place of "Write OK", and it should be easily visible that FF's will be shown across the entire 0x0000 address row or simply that the EEPROM Content View doesn't match the .ROM File Content View. Note: The left Content view shows the current EEPROM contents and can be seen by clicking on the Load EEPROM Content. The Right side Content view is the Bin file that was loaded.

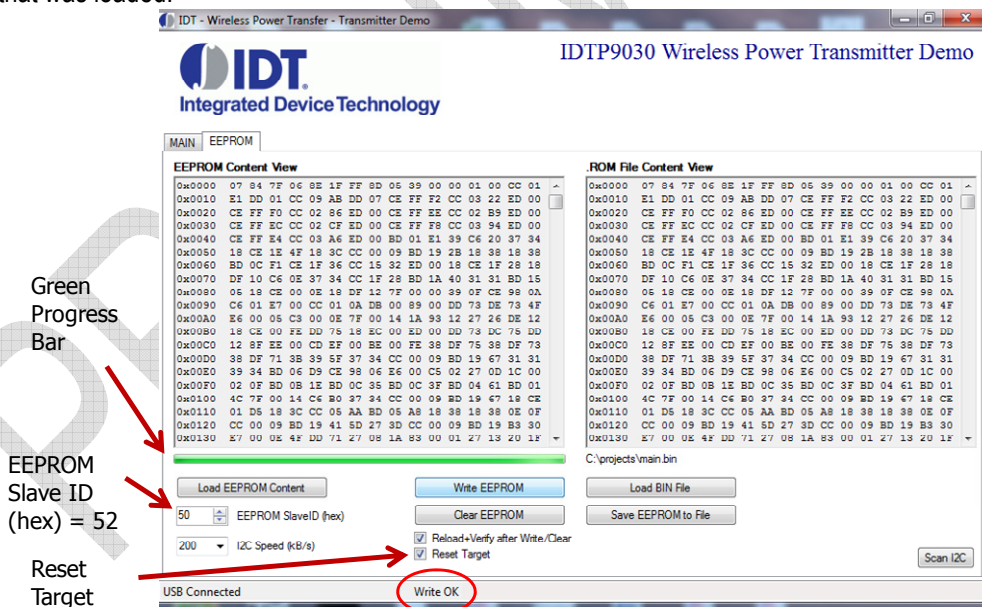

Load BIN file from the CDROM in the '9030tool_final' folder.

Click Write EEPROM and wait for the two **green passes**. Now the left side view should match the right side view, and Write OK should appear. Reset Target is used when programming the EEPROM and can also be used to Reset the Demo Board.

Figure 24. After Loading a BIN File and Writing to the EEPROM

3.5. Troubleshooting

The IDTP9036 demo board was designed to quickly show the performance of the IDTP9036. However, if you are experiencing trouble getting started, here are some tips to help accelerate setup and connectivity.

1. Check to make sure that the PC shows it is connected to the demo board. USB connected should always show at the lower left of the Dongle GUI. If it doesn't it is always good practice to disconnect and reconnect the USB cable, and to disconnect and reconnect the 12V power supply. Unplugging and plugging the USB cable should show an icon appearing and disappearing at the lower right of your computer screen.
2. Depress and release the Reset button. This is the RED button on the demo board. If everything in 1 above is connected and the real time signals are still not streaming across the screen, depress the Red button. Also, enabling then disabling the "Reset Target" box on, and then off, in the EEPROM Tab (Figure 24) will restart the device. Target field box can be used for clearing GUI I²C Read Errors or other system errors.
3. Reload the .bin file and re-write it. Make sure WRITE OK shows at the middle of the display after a write takes place.
4. Select the Scan I2C button (Fig 24 lower right) and check that the slave address for the EEPROM appears as 0x52
5. **Update the Driver.** If you have a previous version of the eval tool, the driver will probably need to be updated. The way to check on the version of the driver is to open up the Device Manager as shown in Figure 23. Expand the USB Bridge Devices and double click on it. Click on the Driver Tab, and be sure its' Driver Date is 7/5/2009 and Version is 7.0.0.0. See Figure 25 through 28. If it is not version 7.0.0.0 then go to directory C:\Program Files\IDT Wireless Power Solution\Drv as shown in Figure 11 and double click the DPInst.exe file. The system will then go through a driver update install. Be sure to reboot your machine once the install is complete.

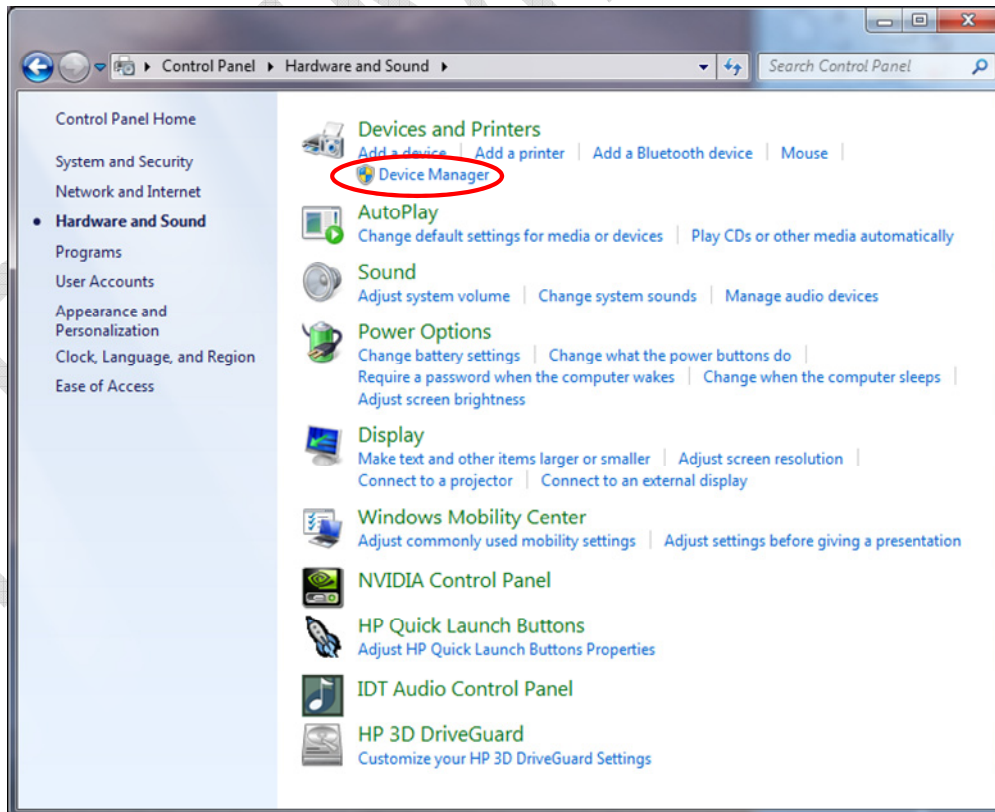

Figure 25. Checking the revision of the driver using Device Manager shown is a Win 7 PC

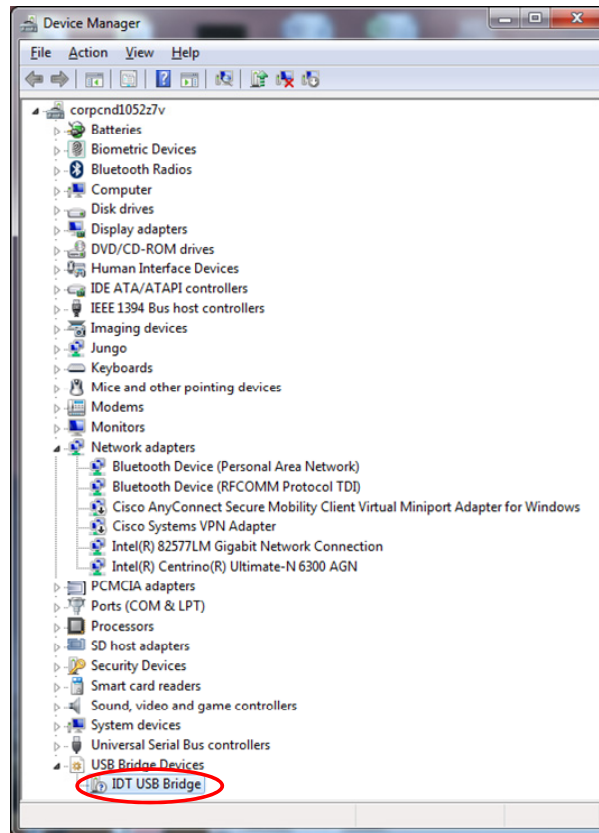

Figure 26 Checking the revision of the driver in Device Manager

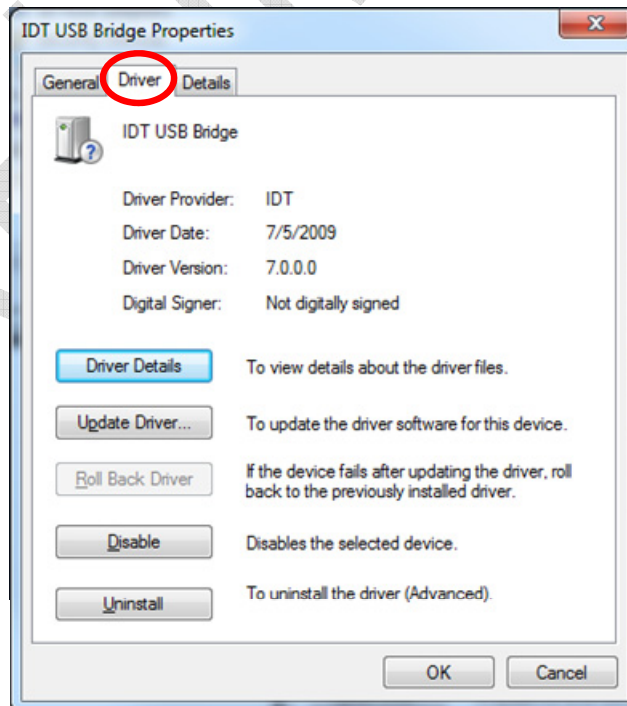

Figure 27. Checking that the revision of the driver is correct

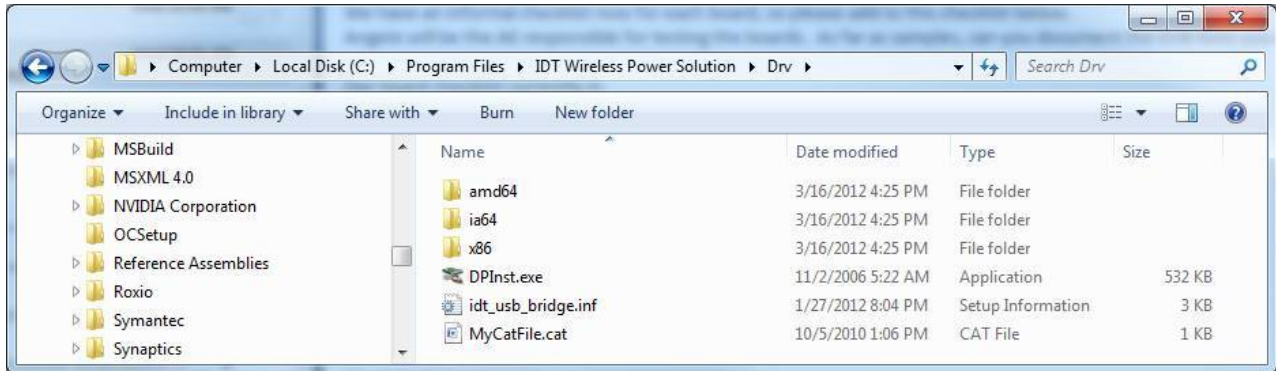

Figure 28. Installed Device Driver Directory

Reference: Debug and Configuration Tabs

These Tabs are for development purposes. One of the features of the Debug tab is the ability to view Real Time System Messages depending upon which of the three fields at the left of the message window is chosen. The Config and Status Tab indicate the status register readings from the device.

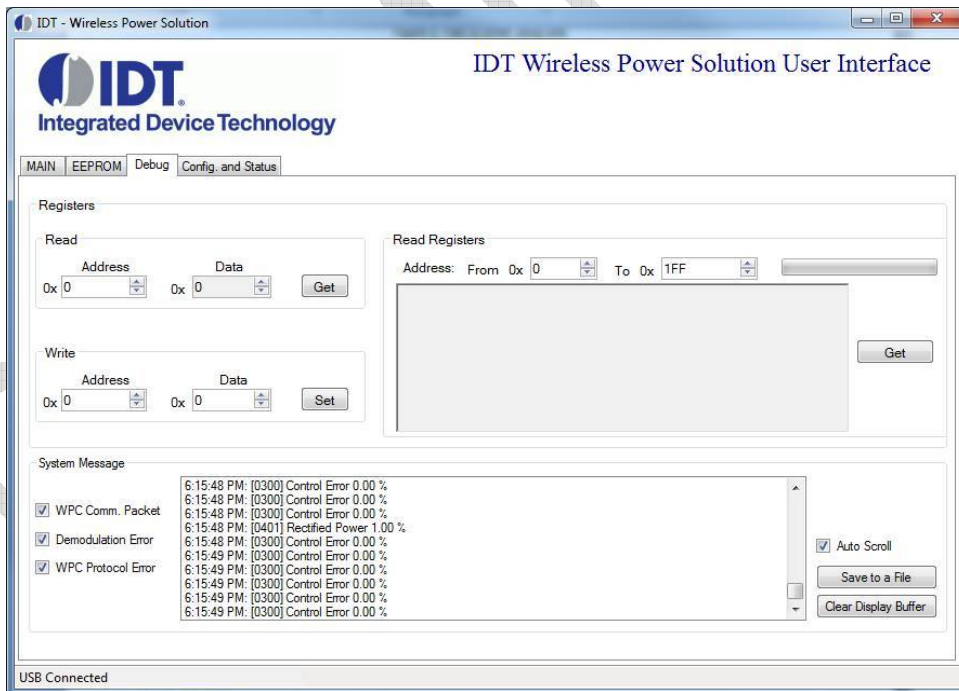

Figure 29. Debug Tab

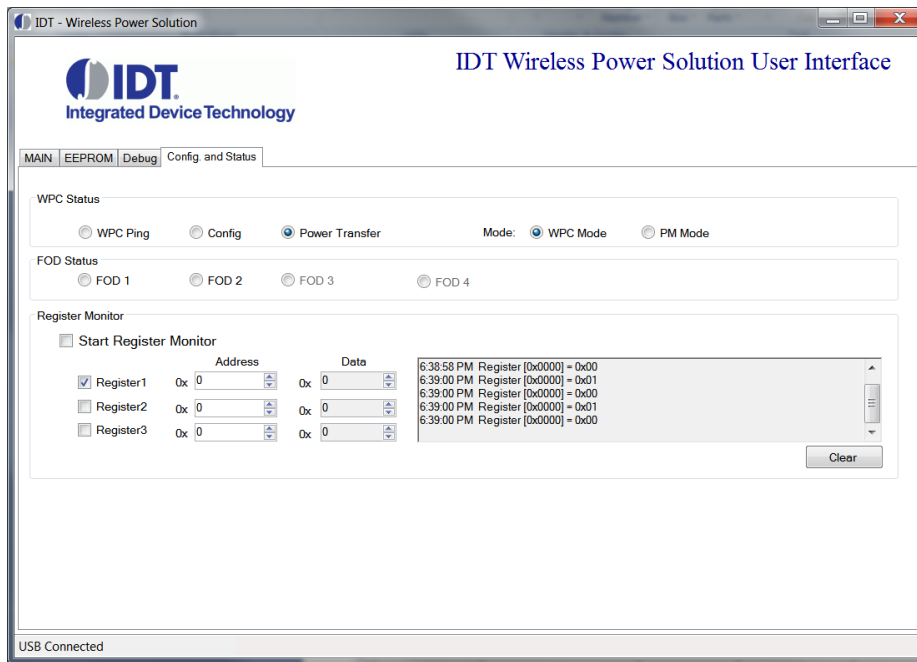

Figure 30. Configuration and Status Tab

4. ORDERING GUIDE

Table 3. Ordering Summary

PART NUMBER	MARKING	PRICE	AMBIENT TEMP. RANGE	SHIPPING CARRIER	QUANTITY
P9036-FPEVK	IDTP9036-TX-A6 EVM Rev1.21	\$149.00	0°C to +70°C	Box 14"x10"x2"	1

NOTES

IMPORTANT NOTICE AND DISCLAIMER

RENESAS ELECTRONICS CORPORATION AND ITS SUBSIDIARIES (“RENESAS”) PROVIDES TECHNICAL SPECIFICATIONS AND RELIABILITY DATA (INCLUDING DATASHEETS), DESIGN RESOURCES (INCLUDING REFERENCE DESIGNS), APPLICATION OR OTHER DESIGN ADVICE, WEB TOOLS, SAFETY INFORMATION, AND OTHER RESOURCES “AS IS” AND WITH ALL FAULTS, AND DISCLAIMS ALL WARRANTIES, EXPRESS OR IMPLIED, INCLUDING, WITHOUT LIMITATION, ANY IMPLIED WARRANTIES OF MERCHANTABILITY, FITNESS FOR A PARTICULAR PURPOSE, OR NON-INFRINGEMENT OF THIRD-PARTY INTELLECTUAL PROPERTY RIGHTS.

These resources are intended for developers who are designing with Renesas products. You are solely responsible for (1) selecting the appropriate products for your application, (2) designing, validating, and testing your application, and (3) ensuring your application meets applicable standards, and any other safety, security, or other requirements. These resources are subject to change without notice. Renesas grants you permission to use these resources only to develop an application that uses Renesas products. Other reproduction or use of these resources is strictly prohibited. No license is granted to any other Renesas intellectual property or to any third-party intellectual property. Renesas disclaims responsibility for, and you will fully indemnify Renesas and its representatives against, any claims, damages, costs, losses, or liabilities arising from your use of these resources. Renesas' products are provided only subject to Renesas' Terms and Conditions of Sale or other applicable terms agreed to in writing. No use of any Renesas resources expands or otherwise alters any applicable warranties or warranty disclaimers for these products.

(Disclaimer Rev.1.01)

Corporate Headquarters

TOYOSU FORESIA, 3-2-24 Toyosu,
Koto-ku, Tokyo 135-0061, Japan
www.renesas.com

Trademarks

Renesas and the Renesas logo are trademarks of Renesas Electronics Corporation. All trademarks and registered trademarks are the property of their respective owners.

Contact Information

For further information on a product, technology, the most up-to-date version of a document, or your nearest sales office, please visit www.renesas.com/contact-us/.