

### Features

- Free positioning TX-A6 3xCoil Charging system
- Enhanced EMI and meets WPC1.1 Specifications
- Wireless Charging active area – 745mm<sup>2</sup>
- WPC compatibility
- Foreign Object Detection (FOD) and indication
- Input voltage range - 11.5V~15V
- Output power - upon the receiver capability up to 5W
- Efficiency - Up to 70%
- Status indication LEDs
- Firmware which enables system monitoring
- Easy programmability by I<sup>2</sup>C

### Evaluation Kit Contents

- IDTP9036A-A6-Demo PCB Rev3.1
- 12V AC-to-DC Power Adapter
- JM60 USB-to-I<sup>2</sup>C Programmer and USB Cable
- CD containing:
  - IDTP9036A-TX-A6 firmware
  - Reference schematic in Orcad
  - Reference layout Cadence Allegro board files
  - Electronic copy of IDTP9036A-TX-A6 UG
  - Electronic copy of IDTP9036A Datasheet

### General Description

The IDTP9036A-TX-A6 evaluation board serves to demonstrate the features and performance of the IDTP9036A Wireless Power Charging solution for Base Stations with a TX-A6 Coil Transmitter. The three coil transmitter system enables a large active power area with high efficiency transfer and enables power to only one coil at a time when the Receiver is detected. The board provides numerous test points to allow detail signal inspection access at different nodes of the circuit to better understand the key functionality of the system.

The evaluation module is a stand-alone application; all it needs is a 12V/1A DC power adapter and a WPC certified power receiver.

Optionally the EVM's activity can be monitored by I<sup>2</sup>C communication and GUI (graphical user interface) software through a USB cabled programmer JM60 dongle board, which interfaces the EVM to the computer. The MAIN tab of the software tool provides real time plots of Coil Current, PWM Frequency, and Duty Cycle including different states of the microcontroller and FOD (foreign object detection).

The evaluation board utilizes an external EEPROM which contains Tx firmware to enable programmability. The external EEPROM memory chip is pre-programmed with a standard start-up program that is automatically loaded when 12V power is applied. The EEPROM can be reprogrammed to suit the needs of a specific application using the IDTP9036A software tool.

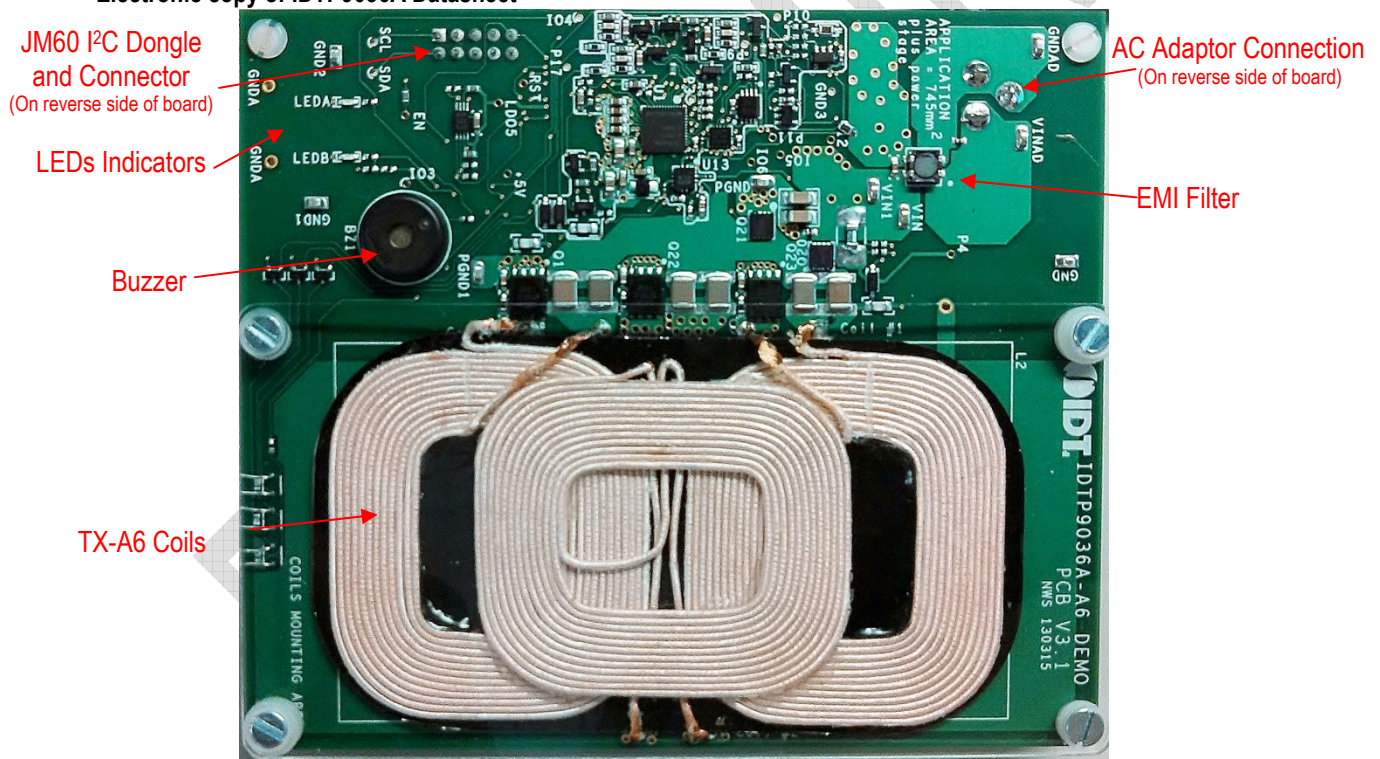

Figure 1 – IDTP9036A-EVAL-TX-A6 Overview

## Table of Contents

1. EVM Hardware .....3	2.2. Typical efficiency curves ..... 13
1.1. Input Power Connection.....3	3. I <sup>2</sup> C INTERFACE ADAPTER AND GUI ..... 14
1.2. EEPROM Programmer Connection .....3	3.1. Installation guide ..... 14
1.3. Testing points.....3	3.2. Verifying Connectivity ..... 15
1.4. LEDs Indication.....3	3.3. Installing the Windows GUI..... 17
1.5. External Temperature sensing .....5	3.4. Writing to the EEPROM ..... 18
1.6. EVM Schematic .....6	3.5. Troubleshooting ..... 19
1.7. Bill of materials.....7	4. ORDERING GUIDE.....23
1.8. PCB Layout Guidelines.....7	5. IMPORTANT NOTES.....Error! Bookmark not defined.
2. PERFORMANCE MEASUREMENTS.....13	
2.1. Output power capability .....13	

## Evaluation Kit Contents

- Evaluation board
- JM60 Programming Dongle
- USB type A to micro-USB type B cable
- Universal AC to 12V DC Power Adapter
- WPC “Qi” Compatible RX Energizer Sleeve
- CD containing:
  - IDTP9036A control software tool
  - IDT USB Device Driver
  - Reference layout Gerber Files
  - Reference layout Cadence Allegro board files
  - Electronic copy of IDTP9036A product datasheet
  - Electronic copy of IDTP9036A-EVAL manual

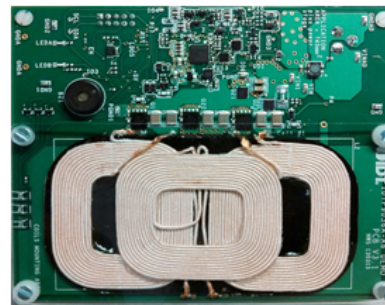

IDTP9036A-EVAL



RX WPC Qi Load



JM60

IDTP9036 A Datasheet



IDTP9036A-EVAL User Manual



Universal AC to 12V DC Adaptor



USB Cable

## 1. EVK Hardware

### 1.1. Input Power Connection

A 12V/1A wall adapter plugged into J3 connector may be used to supply the EVM board, but for measurements, the SMD testing points VIN and GND next to J3 can be used to connect to a lab bench power supply



Figure 2 – AC Adaptor input jack.

### 1.2. EEPROM Programmer Connection

Using the I<sup>2</sup>C adapter is optional and the main purpose is to upload the firmware into the EEPROM (U3). Also the I<sup>2</sup>C adapter may be used to interface the IDTP9036A and the PC GUI – see detailed description on “I<sup>2</sup>C INTERFACE ADAPTER AND GUI” section

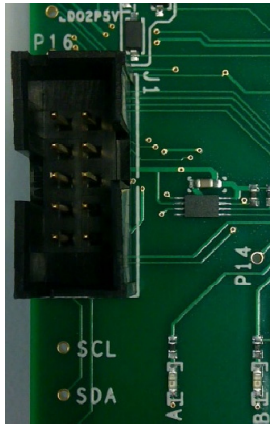

Figure 3 – Keyed JM60 Programmer input 10pin header.

### 1.3. Testing points

There are two types of test points as shown below: SDA, SCL, EN are through hole for probe tips and SMD clip types which may be used for connecting a probe ground lead or probe clip.

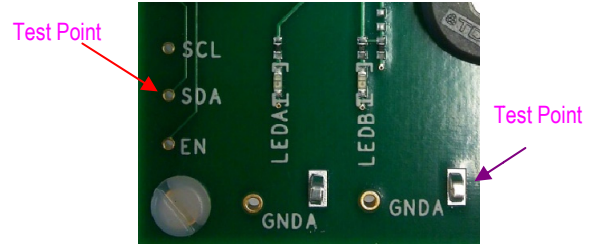

Figure 4 – Surface mount test points.

### 1.4. LED and Buzzer Indicators

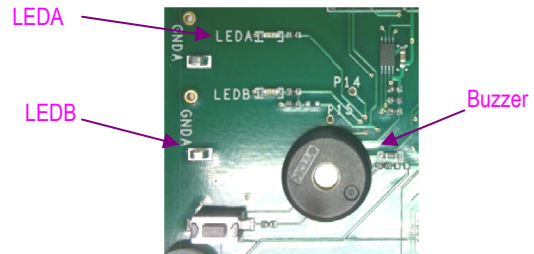

Figure 5 – LED indicators and buzzer connected to GPIOs.

## LED FUNCTIONS

Two GPIOs are used to drive LEDs which indicate, through various on/off and illumination options, the state of charging and some possible fault conditions.

A red LED indicates various Fault and FOD (“Foreign Object Detection”) states. The green LED indicates Power Transfer and Charge Complete state information. Upon power up, the two LEDs together may optionally indicate the Standby State and remain in this state until another of the defined Operational States occurs

As shown in Figure 6, one or two resistors configure the defined LED option combinations. The DC voltage set in this way is read one time during power-on to determine the LED configuration. As not to interfere with the LED operation, the useful voltage range for the DC optioning value must be limited to not greater than 1Vdc.

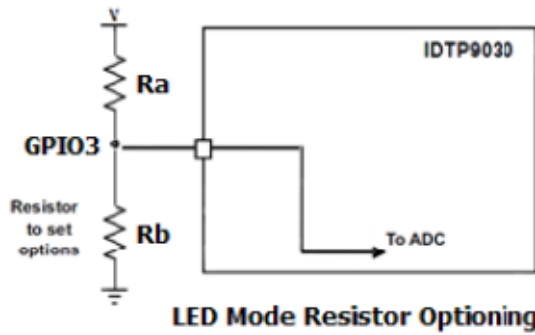

Figure 6. IDTP9036A LED Resistor Options.

Upon power-up, the two LEDs reflect the Standby State and remain in this state until another of the defined Operational States occurs.

There are 10 valid LED option combinations which are selected through the use of two 1% resistors that create a resistor divider value that are read from the GPIOs – two of the LED options are achieved through pull down or pull up (no resistors required). The LED configuration options are detailed in the Table 11.

**LED Pattern Operational Status Definitions:**

Blink Slow: 1s ON, 1s OFF, repeat

Blink Fast: 400ms ON, 800ms OFF, 400ms ON, 800ms OFF, repeat

The red FOD warning LED is synchronized with the buzzer (if implemented) such that a 400ms tone corresponds with FOD red LED illumination and 800ms off (no sound) corresponds with LED being off. During the 30s that the buzzer is off/silenced, the FOD LED must continue to blink.

Table 1 – IDTP9036A LED Resistor Optioning (Not all options supported, shaded rows are for future development).

LED Control Option	LED Select Resistor Value	Description	LED #/ Color	Operational Status				FOD Warning
				Standby	Power Transfer	Charge Complete	Fault Condition	
1	Pull Down	Standby LEDs ON	LED1- Green	ON	BLINK SLOW	ON	OFF	OFF
			LED2- Red	ON	OFF	OFF	ON	BLINK FAST
2	R1	Standby LEDs ON plus	LED1- Green	ON	BLINK SLOW	ON	OFF	OFF
			LED2- Red	ON	OFF	OFF	ON	BLINK FAST
3	R2	Standby LEDs ON plus	LED1- Green	ON	BLINK SLOW	ON	OFF	OFF
			LED2- Red	ON	OFF	OFF	ON	BLINK FAST
4	R3	Standby LEDs ON plus	LED1- Green	ON	BLINK SLOW	ON	OFF	OFF
			LED2- Red	ON	OFF	OFF	ON	BLINK FAST
5	R4	Standby LEDs ON plus	LED1- Green	ON	BLINK SLOW	ON	OFF	OFF
			LED2- Red	ON	OFF	OFF	ON	BLINK FAST
6	Pull Up	Standby LEDs OFF	LED1- Green	OFF	BLINK SLOW	ON	OFF	OFF
			LED2- Red	OFF	OFF	OFF	ON	BLINK FAST
7	R5	Standby LEDs OFF plus	LED1- Green	OFF	BLINK SLOW	ON	OFF	OFF
			LED2- Red	OFF	OFF	OFF	ON	BLINK FAST
8	R6	Standby LEDs OFF plus	LED1- Green	OFF	BLINK SLOW	ON	OFF	OFF
			LED2- Red	OFF	OFF	OFF	ON	BLINK FAST
9	R7	Standby LEDs OFF plus	LED1- Green	OFF	BLINK SLOW	ON	OFF	OFF
			LED2- Red	OFF	OFF	OFF	ON	BLINK FAST
10	R8	Standby LEDs OFF plus	LED1- Green	OFF	BLINK SLOW	ON	OFF	OFF
			LED2- Red	OFF	OFF	OFF	ON	BLINK FAST

R1-R8 are created using combination of two 1% resistors.

Shaded Area Designates Future Option

**Buzzer Function**

An optional buzzer feature is supported on GPIO4. The default configuration is an “AC” buzzer. The signal is created by toggling GPIO4 active-high/active-low at a 2KHz frequency.

**Buzzer Action: Power Transfer Indication**

The IDTP9036A supports audible notification when the device operation successfully reaches the Power Transfer state. The duration of the power transfer indication sound is 400ms.

The latency between reaching the Power Transfer state and the actual buzzer sounding does not exceed 500ms. Additionally, the buzzer sound is concurrent within  $\pm 250\text{ms}$  of any change to the LED configuration indicating the start of power transfer.

**Buzzer Action: No Power Transfer due to Foreign Object Detected (FOD)**

When a major FOD case is detected such that for safety reasons, power transfer is not initiated, or that power transfer is terminated, the buzzer is sounded in a repeating sequence:

For 30 seconds: 400ms ON, 800ms OFF, 400ms ON, 800ms OFF, repeat

Next 30 seconds: Off/silence (but no change to LED on/off patterns)

The pattern is repeated while the error condition exists

The buzzer is synchronized with the FOD LED such that the 400ms on tone corresponds with the Red LED illumination and 800ms off (no sound) corresponds with Red LED being off.

**Decoupling/Bulk Capacitors**

As with any high-performance mixed-signal IC, the IDTP9036A must be isolated from the system power supply noise to perform optimally. A decoupling capacitor of  $0.1\mu\text{F}$  must be connected between each power supply and the PCB ground plane as close to these pins as possible. For optimum device performance, the decoupling capacitor must be mounted on the component side of the PCB. Avoid the use of vias in the decoupling circuit. Additionally, medium value capacitors in the  $22\mu\text{F}$  range must be used at the VIN input to minimize ripple current and voltage droop due to the large current requirements of the resonant half Half-Bridge driver. At least four  $22\mu\text{F}$  capacitors must be used close to the IN pins of the device. Since the operating voltage is 12V, the capacitance value of the capacitors will decrease due to voltage derating characteristics. For example, a  $22\mu\text{F}$  X7R 25V capacitor's value is actually  $10\mu\text{F}$  when operating at 12V.

There must also be a low ESR  $82\mu\text{F}$  to  $100\mu\text{F}$  bulk capacitor connected at the node where the input voltage is applied to the board. A 16V POSCON-type or aluminum electrolytic must be connected between the input supply and ground as shown in Figure 8. POSCON capacitors have much lower ESR than aluminum electrolytic capacitors and will reduce voltage ripple.

**1.5. External Temperature sensing**

The firmware will support external temperature sensing using the circuit shown below. See the IDTP9036A Data Sheet Application Information section about the external temperature sensing (coil temperature) using a 10K thermistor.

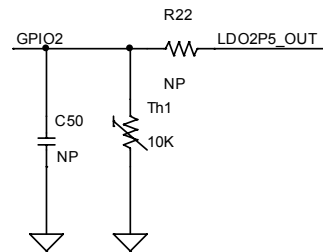

Figure 6 – IDTP9036A GPIO2 connection to external thermistor..

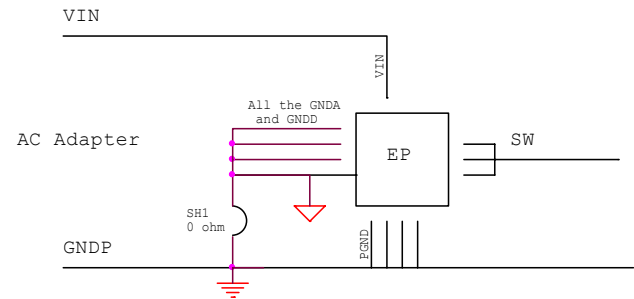
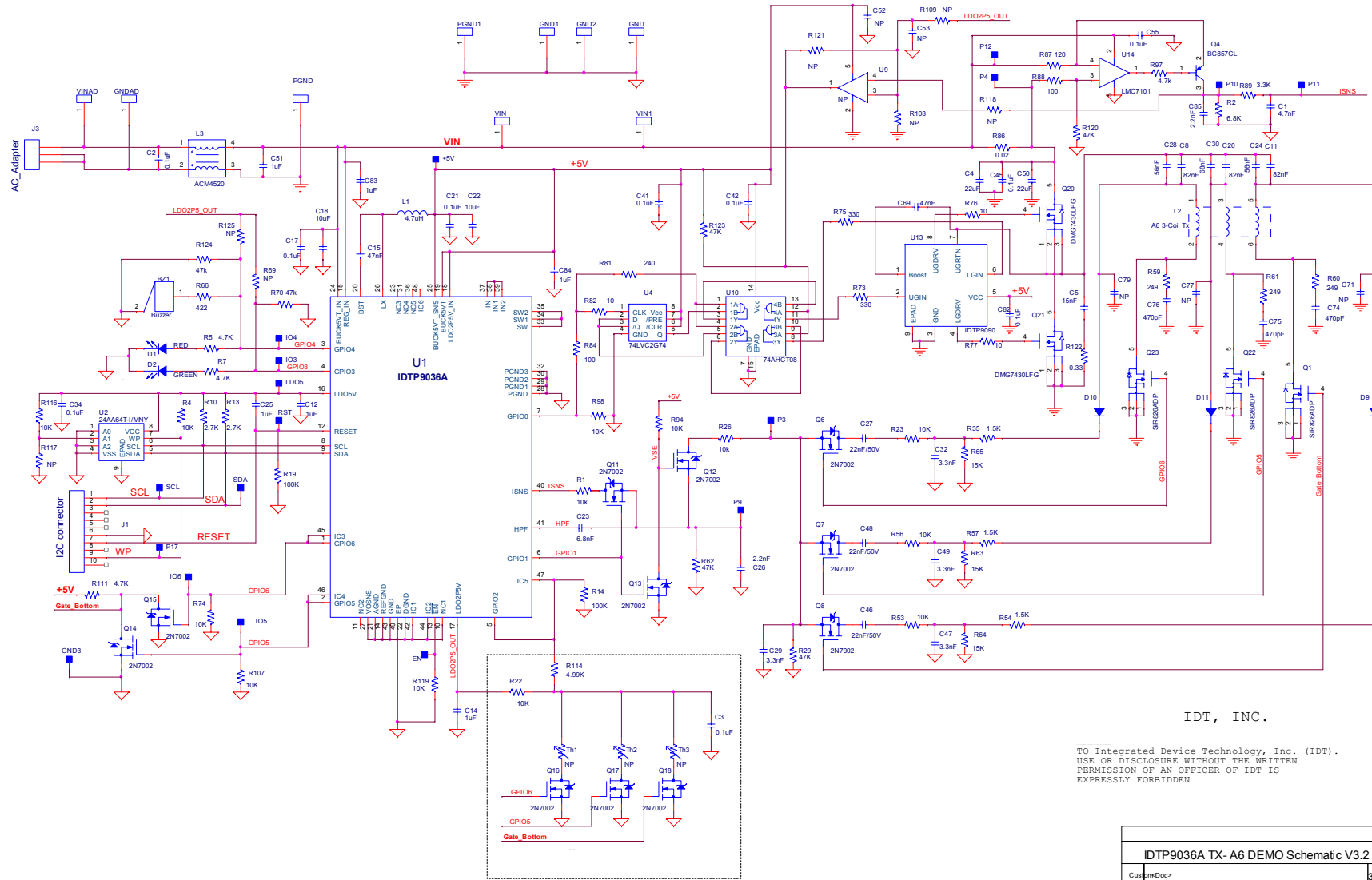

Figure 7. EVM Application Schematic: Grounding scheme

1.6. EVK Schematic



IDT, INC.  
 TO Integrated Device Technology, Inc. (IDT).  
 USE OR DISCLOSURE WITHOUT THE WRITTEN  
 PERMISSION OF AN OFFICER OF IDT IS  
 EXPRESSLY FORBIDDEN

IDTP9036A TX- A6 DEMO Schematic V3.2		
CustomDoc>		3.2
Friday, May 03, 2013 13:12:08	2	2

Figure 8 - EVM Application Schematic: Main schematic

1.7. Table 2 - Bill of materials

Item	Quantity	Part	Manufacturer	Part Number	Reference	Value	PCB Footprint
1	18				P3,I03,GND3,P4,I04,LDO5, I05,+5V,I06,P9,P10,P11, P12,P17,SDA,SCL,RST,EN	VCC	TEST_PT30DPAD
2	1	BUZZER AUDIO PIEZO 25VP-P SMD	TDK	PS1240P02C3	BZ1	Buzzer	buzz_ps1240
3	1	CAP CER 4700PF 50V 10% X7R 0402	TDK	C1005X7R1H472K050BA	C1	4.7nF	402
4	6	CAP CER 0.1UF 50V 10% X7R 0402	TDK	C1005X7R1H104K	C2,C41,C42,C45,C52,C55	0.1uF	402
5	4	CAP CER 0.1UF 50V 10% X7R 0603	Murata	GRM188R71H104KA93D	C3,C17,C21,C34	0.1uF	603
6	2	CAP CER 22UF 25V 10% X5R 1206	Murata	GRM31CR61E226KE15L	C4,C50	22uF	1206
7	1	CAP CER 0.015UF 50V 10% X7R 0402	Murata	GRM155R71H153KA12D	C5	15nF	402
8	3	CAP CER 82nF 100V 5% NPO 1812	TDK	C1812C823J1GACTU	C8,C11,C20	82nF	1812
9	6	CAP CER 1UF 25V 10% X7R 0603	TDK	C1608X7R1E105K	C12,C14,C25,C51,C83,C84	1uF	603
10	1	CAP CER 0.047UF 16V 10% X7R 0603	Murata	GRM188R71C473KA01D	C15	47nF	603
11	2	CAP CER 10UF 25V 20% X5R 0805	TDK	C2012X5R1E106M	C18,C22	10uF	805
12	1	CAP CER 6800PF 50V 10% X7R 0402	TDK	C1005X7R1H682K	C23	6.8nF	402
13	2	CAP CER 0.056UF 100V 5% NPO 1812	Kemet	C1812C563J1GACTU	C24,C28	56nF	1812
14	1	CAP CER 1000PF 50V 10% X7R 0402	TDK	C1005X7R1H102K	C26	1nF	402
15	3	CAP CER 0.022UF 50V 10% X7R 0603	TDK	C1608X7R1H223K	C27,C46,C48	22nF/50V	603
16	1	CAP CER 3300PF 50V 10% X7R 0402	TDK	C1005X7R1H332K	C29	3.3nF	402
17	1	CAP CER 0.068UF 100V 5% NPO 1812	Kemet	C1812C683J1GACTU	C30	68nF	1812
18	3	CAP CER 3300PF 100V 10% X7R 0603	TDK	C1608X7R2A332K	C32,C47,C49	3.3nF	603
19	1	TBD 0402	NP	NP	C53	NP	402
20	1	CAP CER 0.047UF 16V 10% X7R 0603	Murata	GRM188R71C473KA01D	C69	47nF	603
21	3	CAP CER 100PF 200V 5% NPO 0805	Kemet	C0805X101J2GACTU	C71,C77,C79	NP	805
22	3	CAP CER 4700PF 50V 10% X7R 0603	TDK	C1608X7R1H471K	C74,C75,C76	470pF	603
23	1	CAP CER 0.1UF 50V 10% X7R 0402	TDK	C1005X7R1H104K	C82	0.1uF	402
24	1	CAP 25V X7R 0402	TDK	C1005X7R1E222K	C85	2.2nF	402
25	1	LED SMARTLED 630NM RED 0603 SMD	OSRAM	L29K-G1J2-1-0-2-R18-Z	D1	RED	0603_DIODE
26	1	LED SMARTLED GREEN 570NM 0603	OSRAM	LG L29K-G2J1-24-Z	D2	GREEN	0603_DIODE
27	3	DIODE SWITCH 200V 250MW SOD123	Diodes Inc.	BAV21W-7-F	D9,D10,D11	Diode	SOD123
28	9	PC TEST POINT MINIATURE SMT		5015	VIN1,PGND1,GND1,GND2, VINAD,VIN,PGND,GNDAD,GND	TEST POINT	TEST_PT_SM_135X70
29	1	CONN HEADER LOPRO STR 10POS GOLD	TE Connectivity	5103308-1	J1	I2C connector	LOPRO8PIN01INREVB
30	1	PJ-002AH	CUI Inc.	PJ-002AH	J3	AC Adapter	CONN_POWER_JACK5_5MM
31	1	IND 4p7uH 500mA SMD	CoilCraft	XPL2010-472MLB	L1	4.7uH	805
32	1	WPC TX-A6 Transmitter Coil	TDK MingStar Sumida E&E	WT-1005690-12K2-A6-G 312-00017 WPTX-A6-X13008 Y31-60054F	L2	A6 3-Coil Tx	3coil_a6_standard
33	1	CHOKE COMMON MODE 1400 OHM SMD	TDK	ACM4520-901-2P-T-000	L3	ACM4520	emi_tdk_acm4520
34	3	MOSFET N-CH 80V 8-SOIC	Vishay	SIR826ADP	Q1,Q22,Q23	SIR826ADP	SOIC8LD_PWRPAK_FET
35	1	TRANS PNP LP 100MA 45V SOT23	On Semi	BC857CLT1G	Q4	BC857CL	SOT23_3
36	8	MOSFET N-CH 60V 115MA SOT323	NXP	2N7002	Q6,Q7,Q8,Q11,Q12,Q13,Q14, Q15	2N7002	SOT23_3
37	3	MOSFET N-CH SGL 60V 340MA SOT323	On Semi	2N7002WT1G	Q16,Q17,Q18	2N7002	SOT23_3
38	2	MOSFET N CH 30V POWERDIA 3333-8	Diodes Inc.	DMG7430LFG	Q20,Q21	DMG7430LFG	powerdi3333_8ld_fet
39	9	RES 10K OHM 1/10W 5% 0603 SMD	Panasonic	ERJ-3GEYJ103V	R1,R4,R26,R74,R94,R98, R107,R116,R119	10K	402
40	1	RES 6.80K OHM 1/16W 1% 0402 SMD	Yageo	RC0402FR-076K8L	R2	6.8K	402
41	4	RES 4.7K OHM 1/10W 5% 0402 SMD	Panasonic	ERJ-2GEJ472X	R5,R7,R97,R111	4.7K	402
42	2	RES 2.7K OHM 1/10W 5% 0402 SMD	Panasonic	ERJ-2GEJ272X	R10,R13	2.7K	402
43	2	RES 100K OHM 1/10W 5% 0402 SMD	Panasonic	ERJ-2GEJ104X	R14,R19	100K	402
44	1	RES 10.0K OHM 1/10W 1% 0402 SMD	Panasonic	ERJ-2RKF1002X	R22	10K	402
45	6	RES 10.0K OHM 1/10W 1% 0603 SMD	Panasonic	ERJ-3EKF1002V	R23,R35,R53,R54,R56,R57	10K	603
46	4	RES 47K OHM 1/10W 5% 0402 SMD	Panasonic	ERJ-2GEJ473X	R29,R62,R70,R120	47K	402
47	3	RES 249 OHM 1/10W 1% 0603 SMD	Panasonic	ERJ-3EKF2490V	R59,R60,R61	249	603
48	3	RES 15K OHM 1/10W 5% 0603 SMD	Panasonic	ERJ-3GEYJ153V	R63,R64,R65	15K	603
49	1	RES 422 OHM 1/10W 1% 0402 SMD	Panasonic	ERJ-2RKF4220X	R66	422	402
50	2		NP	NP	R69,R117	NP	402
51	2	RES 330 OHM 1/10W 5% 0603 SMD	Panasonic	ERJ-1GEJ331C	R73,R75	330	201
52	2	RES 10 OHM 1/20W 5% 0201 SMD	Panasonic	ERJ-1GEJ100C	R76,R77	10	201
53	1	RES 240 OHM 1/10W 5% 0402 SMD	Panasonic	ERJ-2GEJ241X	R81	240	402
54	1	RES 10 OHM 1/20W 5% 0201 SMD	Panasonic	ERJ-1GEJ100C	R82	10	201
55	1	RES 100 OHM 1/10W 5% 0603 SMD	Panasonic	ERJ-3GEYJ101V	R84	100	603
56	1	RES 0.02 OHM 0.5W 1% 1206 SMD	Yageo	PF1206FRF070R02L	R86	0.02	2512
57	2	RES 120 OHM 1/10W 5% 0402 SMD	Panasonic	ERJ-2GEJ121X	R87	120	402
58	2	RES 100 OHM 1/10W 5% 0402 SMD	Panasonic	ERJ-2GEJ101X	R88	100	402
59	1	RES 3.3K OHM 1/10W 5% 0402 SMD	Panasonic	ERJ-2GEJ332X	R89	3.3K	402
60	1	RES 100K OHM 1/10W 1% 0402 SMD	TBD	TBD	R108	NP	402
61	1	RES 22K OHM 1/10W 1% 0402 SMD	Panasonic	ERJ-2RKF2202X	R109	22K	402
62	1	RES 4.99K OHM 1/10W 1% 0402 SMD	Panasonic	ERJ-2RKF4991X	R114	4.99K	402
63	1	RES 3.92K OHM 1/10W 1% 0402 SMD	Panasonic	ERJ-2RKF3921X	R118	3.92K	402
64	1	RES 100K OHM 1/10W 1% 0402 SMD	Vishay/Dale	CRCW040243K0JINED	R121	43K	402
65	1	RES 0.33 OHM 1/10W 1% 0603 SMD	Panasonic	ERJ-3RQJR33V	R122	0.33	402
66	3	THERMISTOR NTC K 5% RADIAL	Vishay	NTCLE203E3103JB0	Th1,Th2,Th3	NP	NTC1
67	1	Wireless Power TX Controller	IDT Inc.	IDTP9036A	U1	IDTP9036A	NTG 48LD_6X6MM_0P4PITCH
68	1	IC EEPROM 64KBIT 400KHZ 8TDFN	Microchip	24AA64T-I/MNY	U2	24AA64T-I/MNY	DFN8
69	1	IC D-TYPE F-F W/CLR PRESET SM8	TI	SN74LVC2G74	U4	74LVC2G74	LSSOP_8LD
70	1	IC AMP SINGLE R-R I/O SOT23-5	Fairchild	FAN4174I55XCT-ND	U9	FAN4174	SOT_23_5
71	1	IC Quad 2 Input AND Gate	NXP	74AHCT08BQ,115	U10	74AHCT08	DHVQFN_14LD_2p5x3mm
72	1	IC OPAMP GP R-R CMOS 1MHZ SC70-5	ADI	AD8614ARTZ-REEL7	U12	AD8614	SOT_23_5
73	1	High and Low Side N-Channel Gate Driver	IDT Inc.	IDTP9090	U13	IDTP9090	nlg8LD_3x3_0p65mm

**Note 1:** Recommended capacitor temperature/dielectric and voltage ratings: 100V capacitors are recommended because 100Vp-p voltage transients may appear on the resonance capacitors as stated in the WPC specification. COG/NPO-type capacitor values stay relatively constant with voltage while X7R and X5R ceramic capacitor values de-rate from 40% to over 80%. The decision to use lower voltage 50V capacitors or other type temperature/dielectric capacitors is left to the end user.

1.8. PCB Layout Guidelines

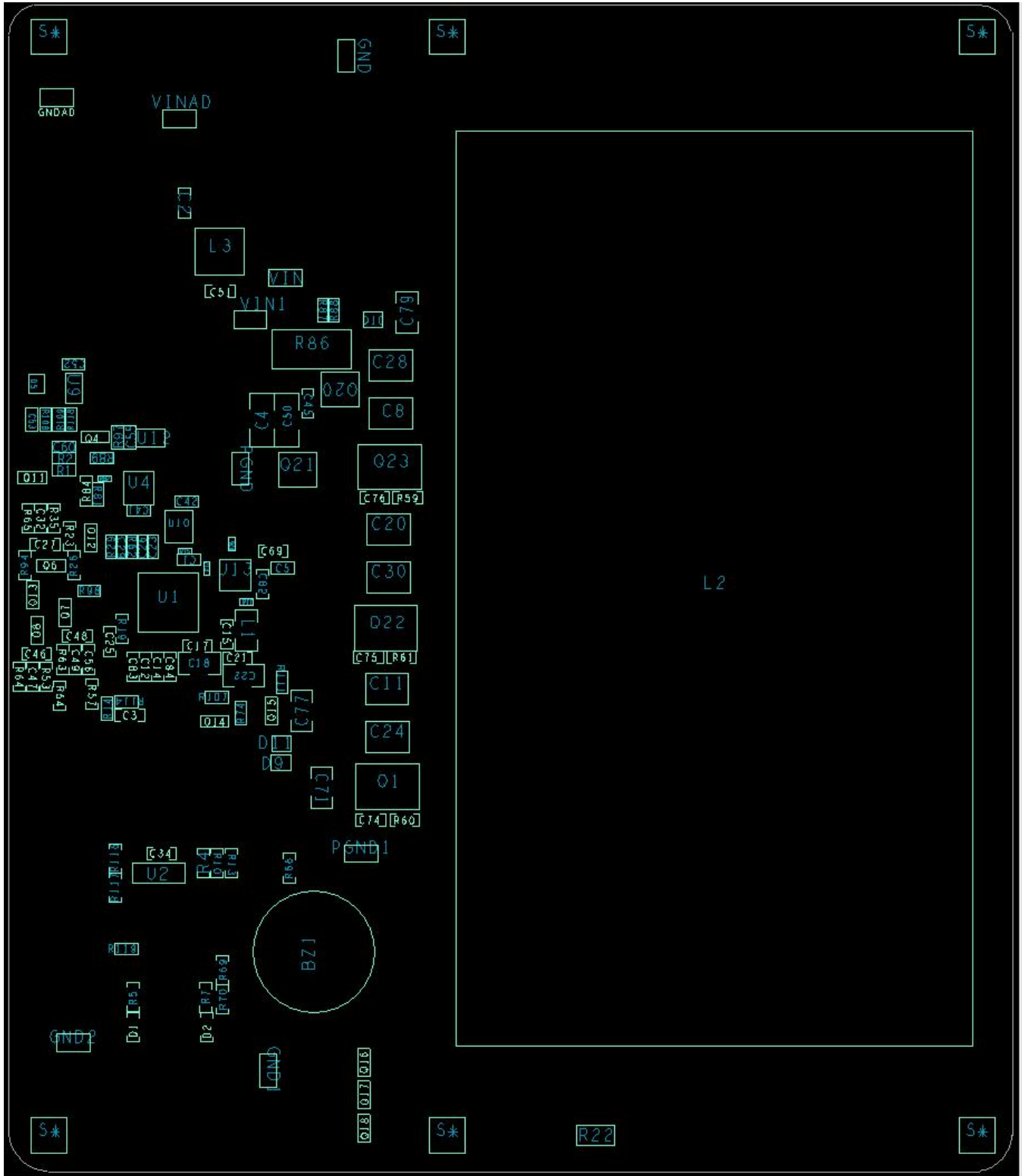

Figure 9 - Component Map



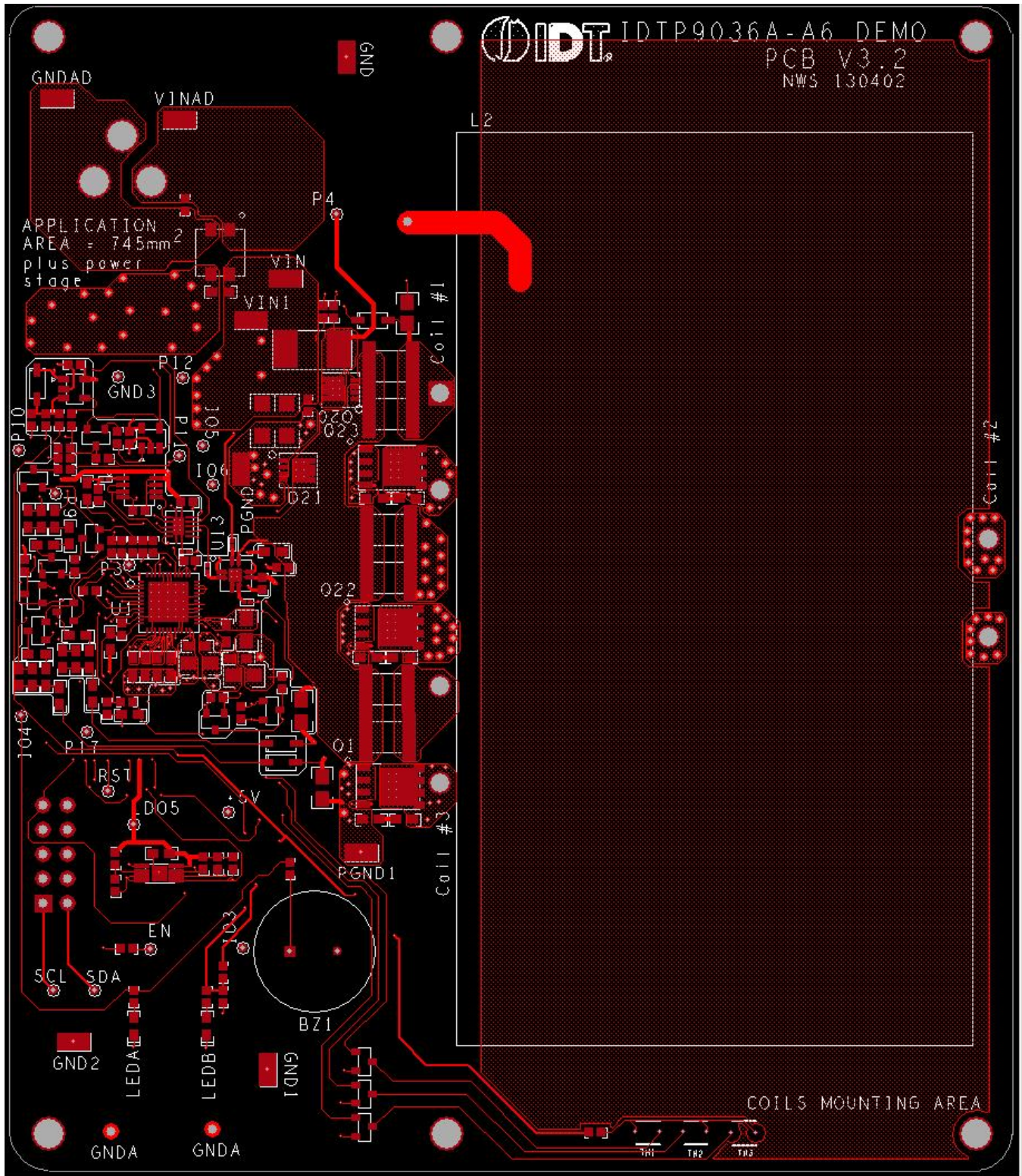

Figure 10 - Top Layer and Top Silkscreen Layer

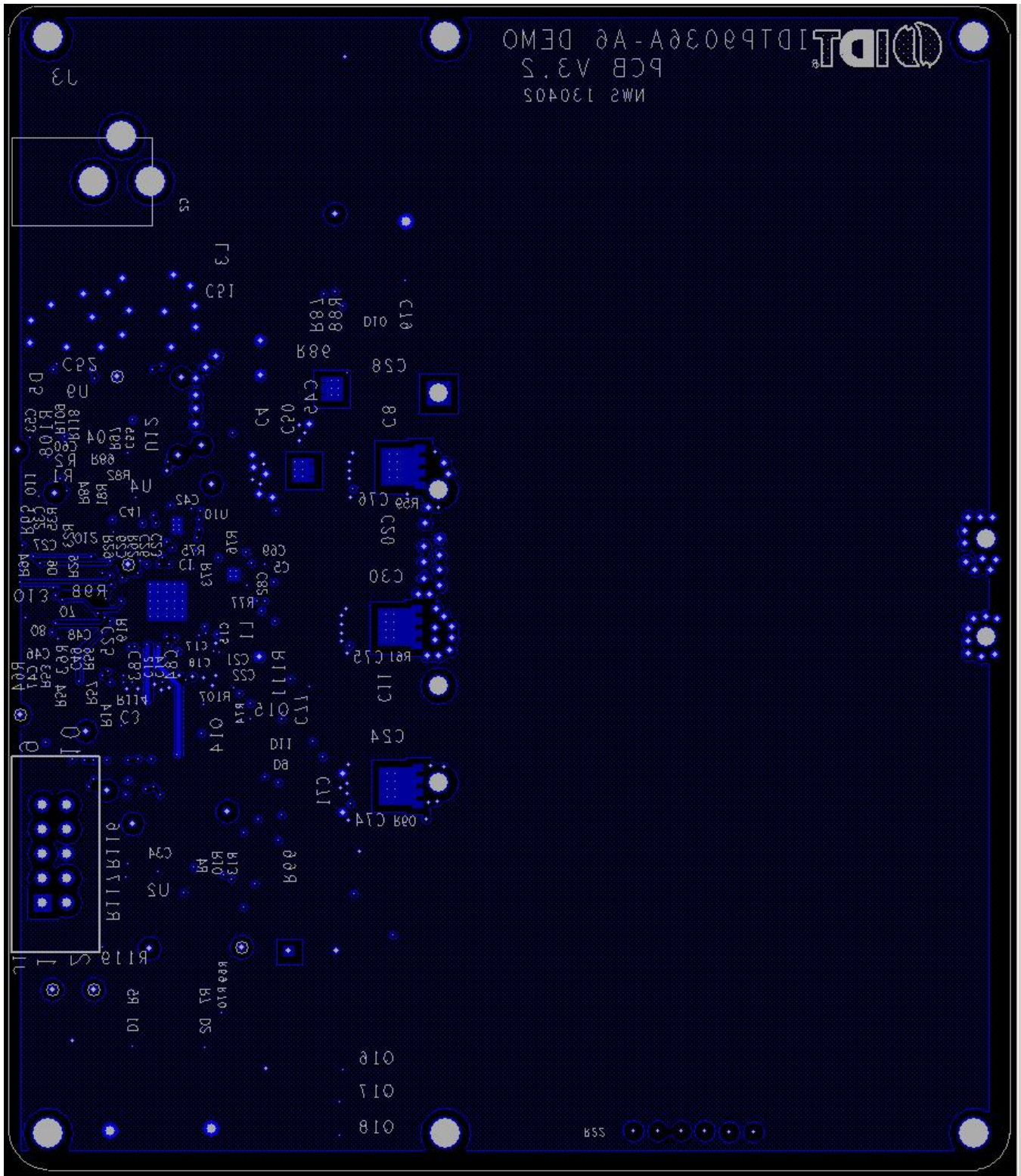

Figure 11 - Bottom Layer and Bottom Silkscreen Layer

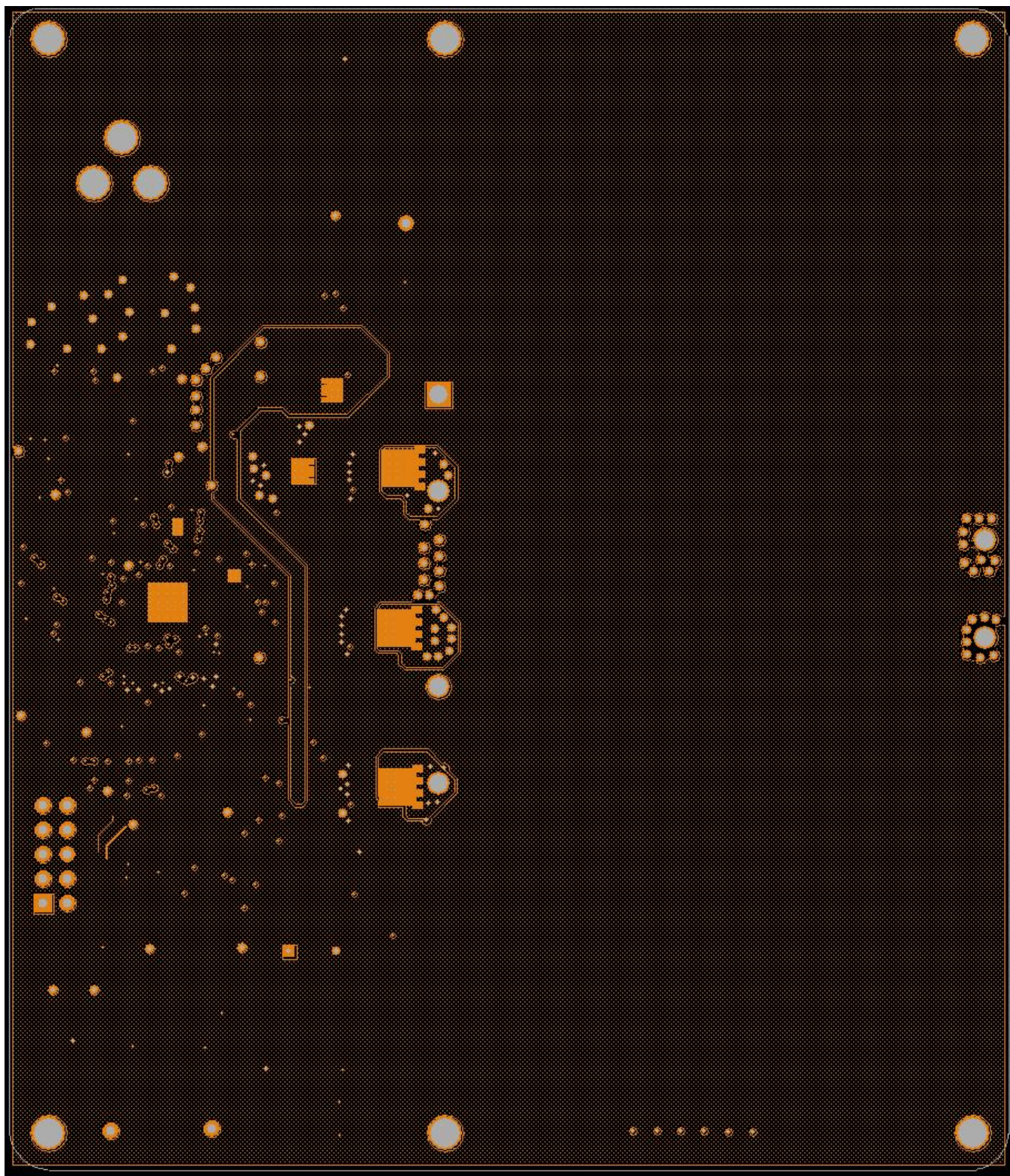

Figure 12 - Mid1 Layer

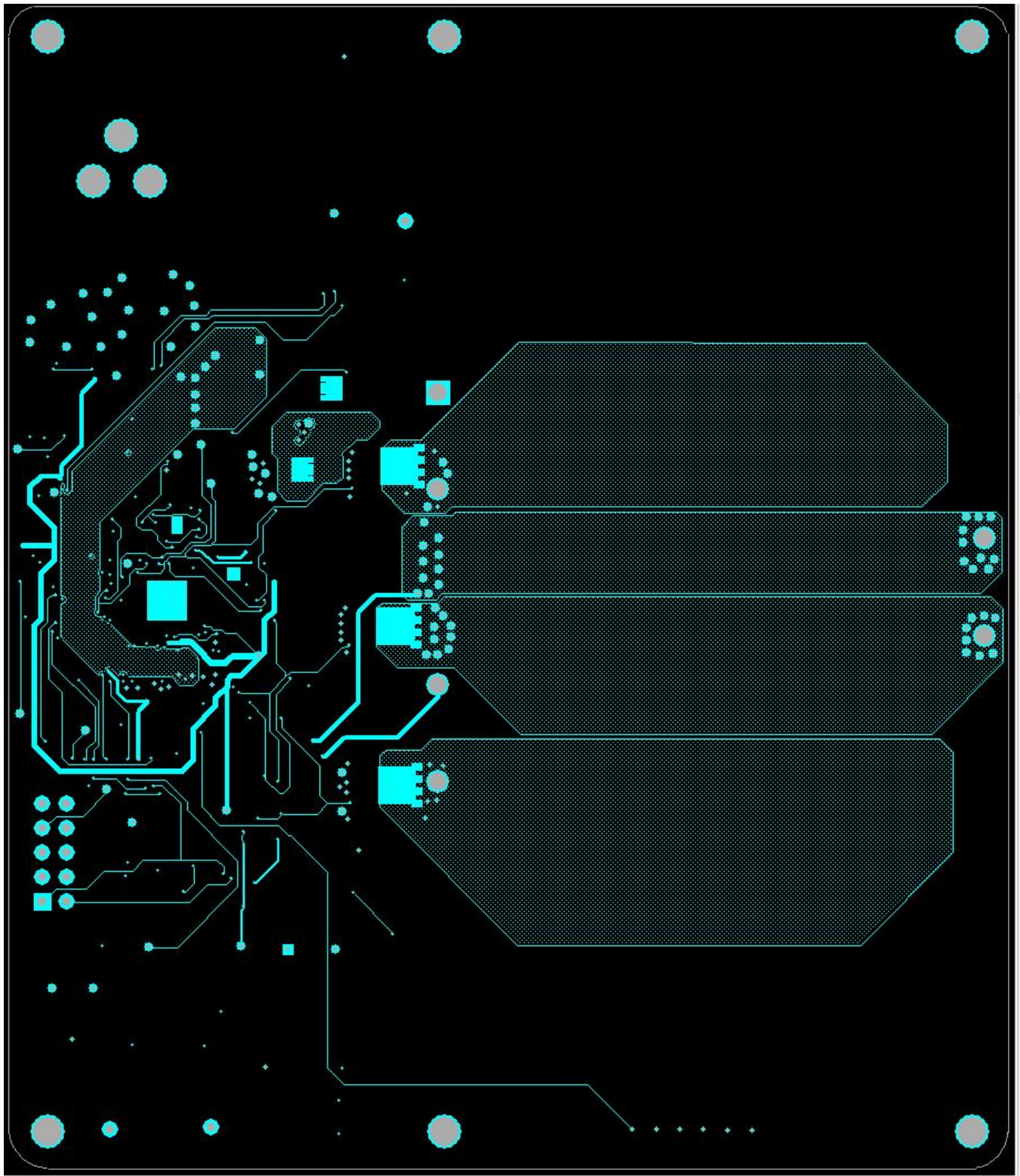

Figure 13 - Mid 2 Layer

## 2. PERFORMANCE EVALUATION

### 2.1. IDTP9036A Switching frequency

Use a universal RX module to receive power from the IDTP9036AEVM and plot the switching frequency versus load current.

There are various power receiver models found on the market, and the plot may also vary.

Below is an example of a typical frequency characteristic versus varying load requirements.

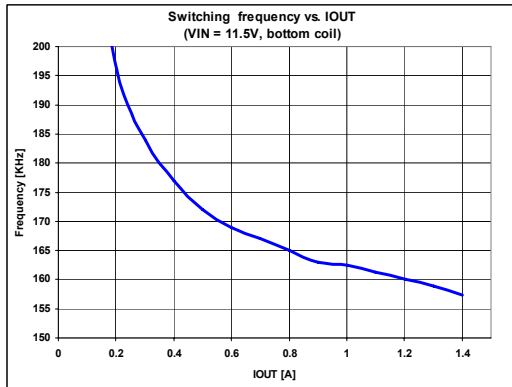

Figure 14 – IDTP9036A Switching frequency versus power.

### 2.2. Power transfer efficiency

The efficiency is measured by comparing the input power to the output power

$$\eta = \frac{P_{out}}{P_{in}} = \frac{V_{out} \cdot I_{out}}{V_{in} \cdot I_{in}}$$

The chart below shows a typical efficiency characteristic versus load current

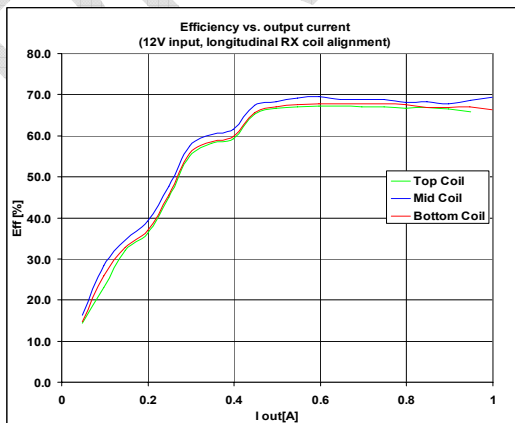

Figure 15 – TX to RX efficiency versus output current.

### 2.3. Load Transient

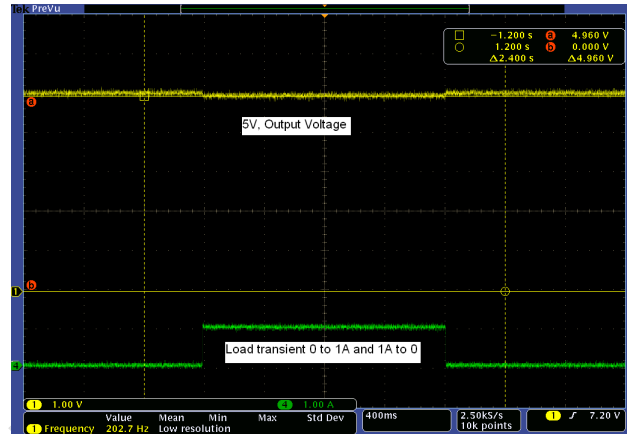

Figure 16 – TX to RX load transient.

### 2.4. Coil Waveforms

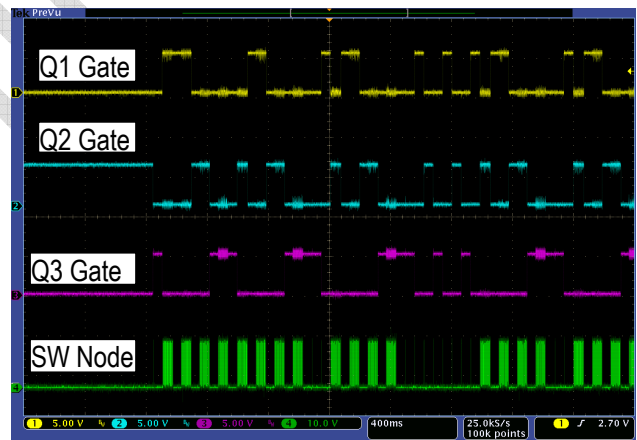

Figure 17 – TX-A6 three coil waveforms during detect mode..

### 3. I<sup>2</sup>C INTERFACE ADAPTER AND GUI

This IDTP9036A-TX-A6 EVM is designed to demonstrate the performance and functionality of the IDTP9036A wireless transmitter in a lab bench test environment. In most cases, this board can be wired into an existing system for evaluation. For complex or electrically sensitive situations, it is recommended to use the reference layout to integrate this design into the final system to eliminate hardware limitations or signal degradation introduced by long leads.

With no computer interface, this evaluation board can function in its pre-programmed mode of operation using a 12V power supply or AC adaptor. To evaluate the full potential of this device, a PC with USB output is required. Everything you need is included in this evaluation kit.

#### 3.1. Installation guide

Follow these simple steps to power-up and enable the power management features of the IDTP9036A:

1. Connect the USB cable from a PC to the 1" x 2" JM60 programming board. The JM60 board has already been programmed at the factory.
2. Connect the JM60 to the connector of the IDTP9036A-TX-A6 EVM board (J1 Figure 18).
3. Plug the AC adaptor into the wall (120 VAC) and connect the other end (12 VDC) into the adapter plug on the EVM board (J3 Figure 18).
4. Next, install the Wireless Power Demo Windows GUI software by executing the Setup.exe file in the folder "9036Tool\_final" (Figure 19).
5. Click Start >> All Programs >> Integrated Device Technology (Folder) >> Wireless Power Demo (Application Icon) to open the GUI for IDTP9036A Wireless Power Transmitter Demo software Fig 20.

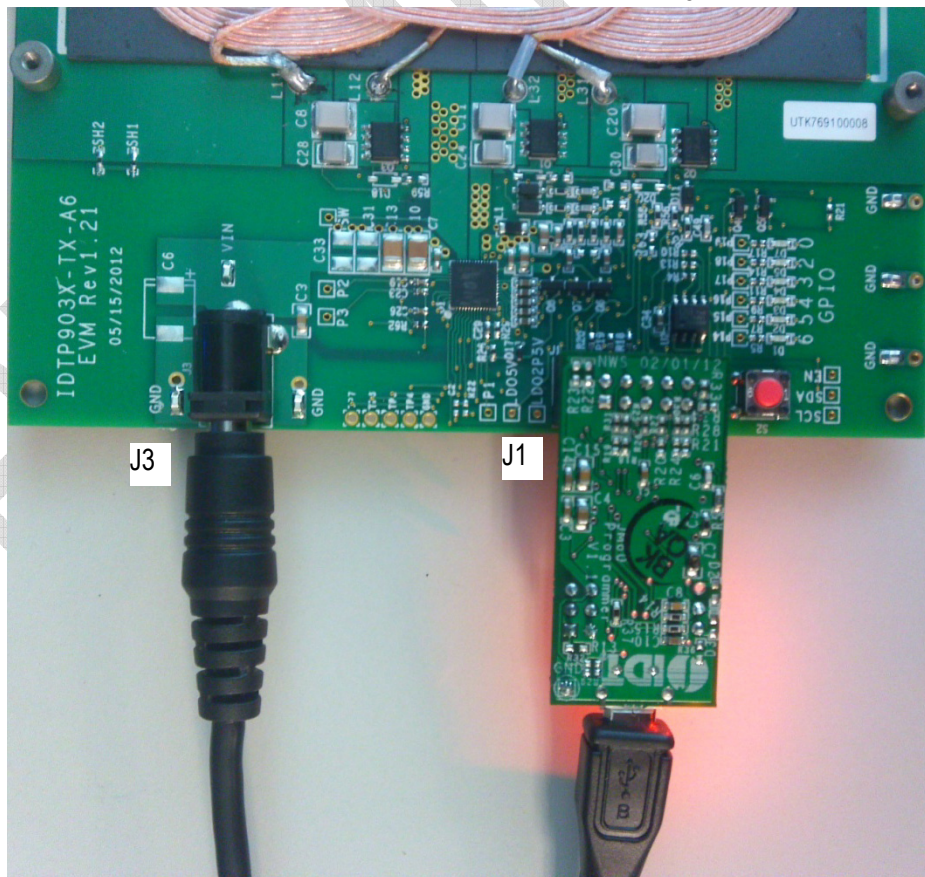

Figure 18. IDTP9036A-EVAL JM60, AC Adaptor connections.

6. Without an RX load on the coil, note which LEDs are lit up on the eval board. Now place a load onto the coil and observe the different LEDs that light up depending upon where the RX load is placed onto the coils. The LEDs are defined in Figure 5. Also observe the different real time signals propagating on the GUI (Figure 21). Any problems see Troubleshooting page 19.

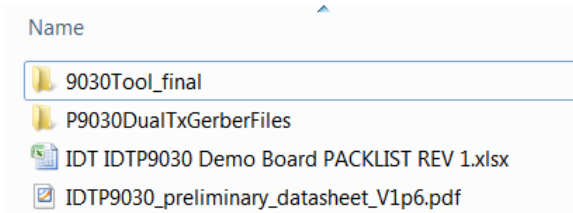

Figure 19. File folder structure on the CDROM.

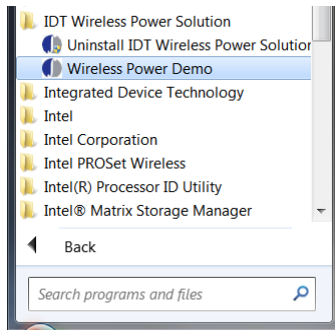

Figure 20. Starting the Graphical User Interface

### 3.2. Verifying Connectivity

You can verify that the IDTP9036A is properly connected to your computer and able to communicate with the evaluation board by looking at the lower left of Figure 21. It should state “USB Connected”. Otherwise it will state in Red letters: “USB Disconnected – Check Connection”.

If it states **USB Disconnected**, it might be that the driver was not properly installed on the PC. Check that a USB Connector icon appears and disappears, at the lower right of the Windows Taskbar, as the Cable’s USB Connector is plugged and unplugged from the USB port. If it does not appear, then proceed to Troubleshooting section, item 5.

- 1) The MAIN tab of the GUI provides 3 real time signals: PWM Frequency, Coil Current, and Duty Cycle.
- 2) Placing different Rx objects and loads onto the coils will change the real time signals, and it will change the location of the Blue “dot” at the left side of the GUI’s MAIN tab (Figure 21). For example, when the system is first turned-on, and without a load on the coil, the Blue “dot” will flash, i.e. “ping”, at the WPC Ping text location, at the very top left hand side of GUI. Then, when a load is placed on the coil, the flashing Blue “dot” at WPC Ping will cease and a solid Blue dot will appear at the Power Transfer Line text location on the left hand side of the GUI. Also, it should be noted that the red LEDs D3 and D4 will flash on/off on the eval board without an RX. Note, however, that if the load is connected to one of the three coils, the red LEDs will turn on as shown in Figure 5 and Table 1. Also, once the RX has established good communication with the evaluation board, the Rx Detected and Power Transfer “non flashing” solid Blue dots located just below the real time signals on the MAIN tab of the GUI will appear, Figure 21. Moving the RX on the coils will change the Coil Selection LEDs as shown in Table 1.

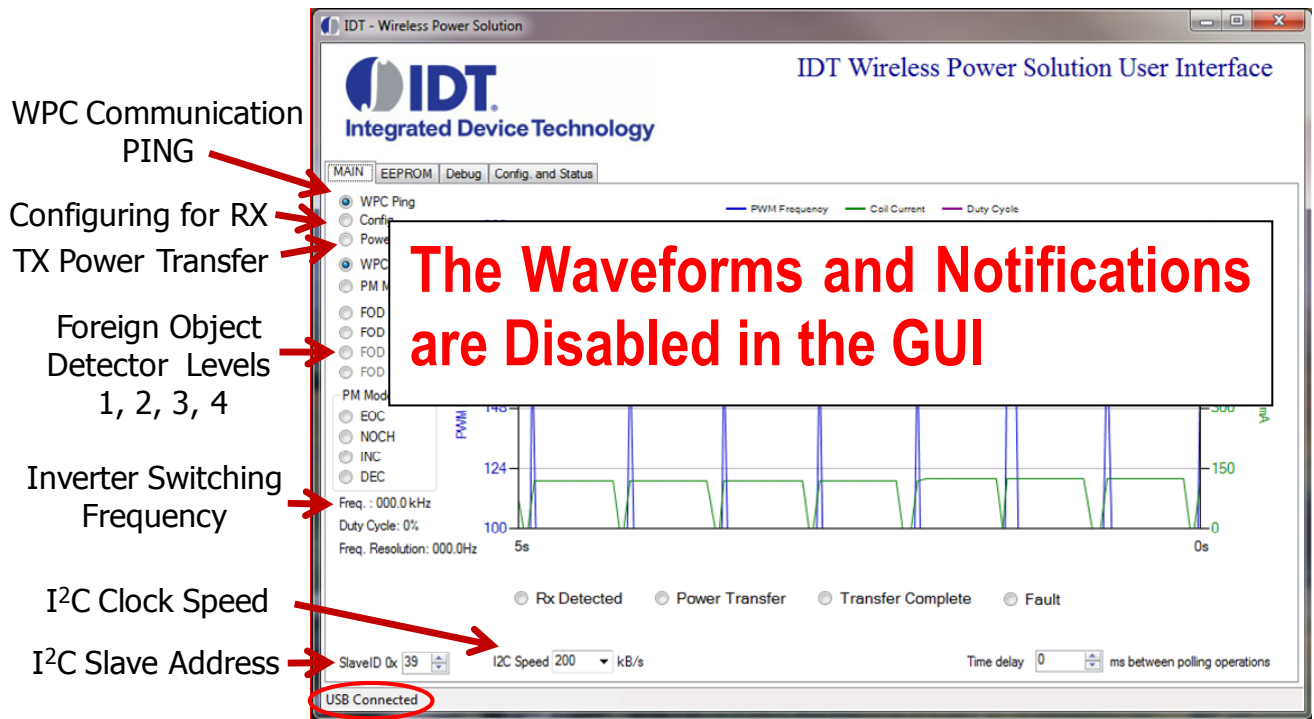

Figure 21. Windows GUI Main tab



### 3.3. Installing the Windows GUI

For the first time use of the IDTP9036A-TX-A6 EVM board or to write a new binary file into the EEPROM, the Windows Drivers and GUI must be installed to communicate with the JM60 USB to I<sup>2</sup>C controller that is located on the JM60 Programmer Dongle board. The JM60 Dongle board is attached to the left side of the DEMO board, and is connected via a 10pin keyed header on the top side of the board. The purpose of this controller is to be able to write different ".bin" files into the EEPROM on the DEMO board, and to be able to acquire real time signals showing system operation. Different .bin files can be made available, for example, when a different output power setting test is desired.

Example installation of the Windows USB-to I<sup>2</sup>C-Drivers on a Win7 32-bit or 64-bit system is shown in the following steps:

To install the GUI, open the IDTP9036A-DEMO CD and run the file: setup-1.0.0.11.exe within the 9036Tool\_final folder. I.e. the path is 9036Tool\_final/setup-1.0.0.11.exe shown in figure 19 or 22. Follow the Setup Wizard instruction shown in Figure 23. This will install the GUI and driver automatically. After the installation process is complete, you may connect the evaluation board to the computer with the USB cable, via the Dongle, and use the software tool. *At this point, a little USB icon should appear at the lower right of the desktop screen. If it does not, then the machine being used should be rebooted. Now connect the JM60 dongle board into the evaluation board and then connect the 12V supply. Now plug the USB cable into the dongle board, and plug the USB cable into the PC.*

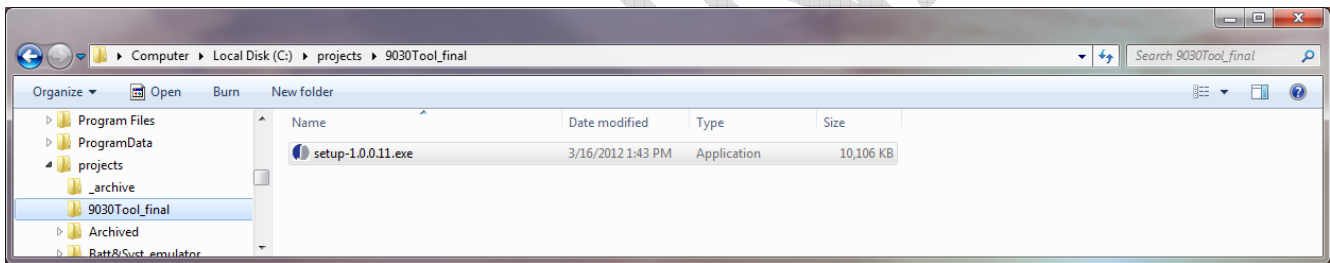

Figure 22. Path to driver setup.exe



Figure 23. Setup Wizard

### 3.4. Writing to the EEPROM

#### Loading the .bin File

The EEPROM already comes with a standard BIN file programmed into it, which gets downloaded to the IDTP9036A upon power up. However, if another one has been provided by the factory, the way to write it into the EEPROM is as follows:

- 1) Plug the USB cable from the computer to the dongle's USB type B connector.
- 2) Plug the dongle into the IDTP9036A-TX-A6 EVM board. Make sure only a jumper exists on J4 of the dongle in a position closest to the USB connector.
- 3) Plug the 12V power supply into the IDTP9036A-TX-A6 EVM Board.
- 4) Click Start >> All Programs >> Integrated Device Technology (Folder) >> Wireless Power Demo.
- 5) Click on the EEPROM tab directly right of the MAIN tab.
- 6) Click on the Load Bin file and browse to the path where the new bin file is located, for example, on the CD (type .bin).
- 7) Referencing Figure 24, click the Reset Target box so it shows a check mark
- 8) Set the EEPROM Slave ID to 52 and select the Scan I2C button (Fig 24 lower right) and check that the slave address for the EEPROM appears as 0x52 and then.
- 9) Click the Write EEPROM button, the green progress bar should increase in size from left to right and two **green passes** should be observed as the file is written to the EEPROM and then the Write OK should appear at the bottom of the screen. If not, click the Write EEPROM button again until Write OK appears.
- 10) Finally, to get the LEDs on the DEMO board to start flashing, the Reset Target check mark has to be unchecked. Uncheck it and the various LEDs will start flashing.

If a Write OK is not shown in step 8, then refer to the Troubleshooting section on page 19. "Error Writing" is what should be shown in place of "Write OK", and it should be easily visible that FF's will be shown across the entire 0x0000 address row or simply that the EEPROM Content View doesn't match the .ROM File Content View. Note: The left Content view shows the current EEPROM contents and can be seen by clicking on the Load EEPROM Content. The Right side Content view is the Bin file that was loaded.

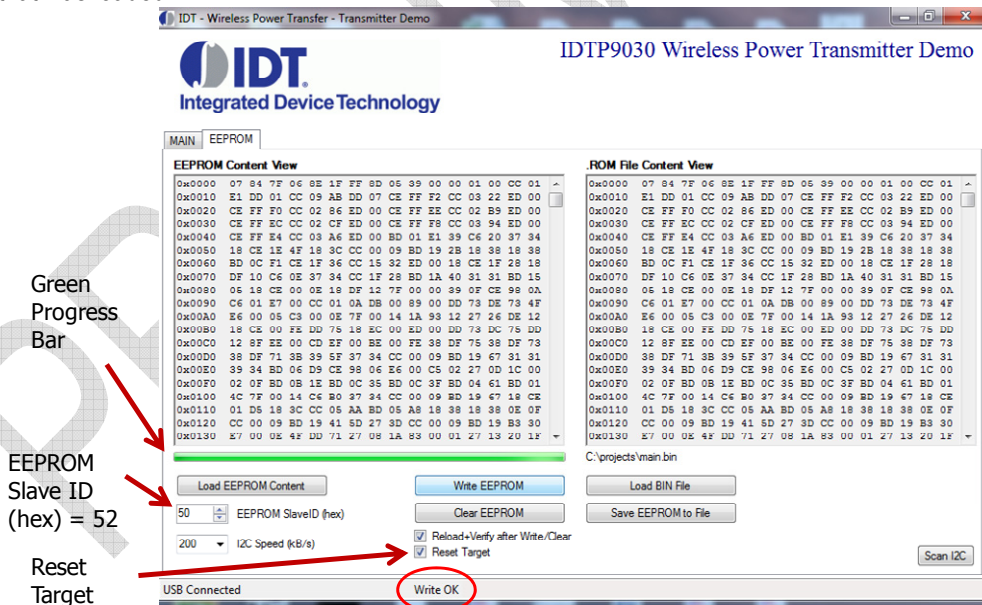

Load BIN file from the CDROM in the '9030tool\_final' folder.

Click Write EEPROM and wait for the two **green passes**. Now the left side view should match the right side view, and Write OK should appear. Reset Target is used when programming the EEPROM and can also be used to Reset the Demo Board.

Figure 24. After Loading a BIN File and Writing to the EEPROM

### 3.5. Troubleshooting

The IDTP9036A demo board was designed to quickly show the performance of the IDTP9036A. However, if you are experiencing trouble getting started, here are some tips to help accelerate setup and connectivity.

1. Check to make sure that the PC shows it is connected to the demo board. USB connected should always show at the lower left of the Dongle GUI. If it doesn't it is always good practice to disconnect and reconnect the USB cable, and to disconnect and reconnect the 12V power supply. Unplugging and plugging the USB cable should show an icon appearing and disappearing at the lower right of your computer screen.
2. Depress and release the Reset button. This is the RED button on the demo board. If everything in 1 above is connected and the real time signals are still not streaming across the screen, depress the Red button. Also, enabling then disabling the "Reset Target" box on, and then off, in the EEPROM Tab (Figure 24) will restart the device. Target field box can be used for clearing GUI I<sup>2</sup>C Read Errors or other system errors.
3. Reload the .bin file and re-write it. Make sure WRITE OK shows at the middle of the display after a write takes place.
4. Select the Scan I2C button (Fig 24 lower right) and check that the slave address for the EEPROM appears as 0x52
5. **Update the Driver.** If you have a previous version of the eval tool, the driver will probably need to be updated. The way to check on the version of the driver is to open up the Device Manager as shown in Figure 23. Expand the USB Bridge Devices and double click on it. Click on the Driver Tab, and be sure its' Driver Date is 7/5/2009 and Version is 7.0.0.0. See Figure 25 through 28. If it is not version 7.0.0.0 then go to directory C:\Program Files\IDT Wireless Power Solution\Drv as shown in Figure 11 and double click the DPInst.exe file. The system will then go through a driver update install. Be sure to reboot your machine once the install is complete.

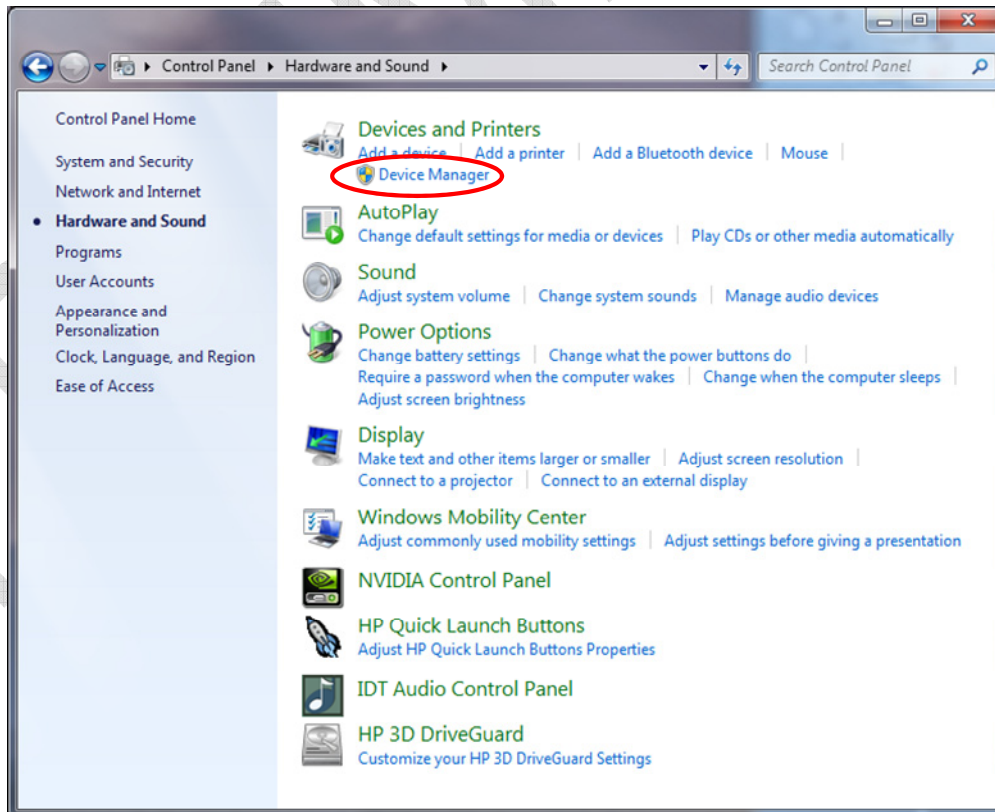

Figure 25. Checking the revision of the driver using Device Manager shown is a Win 7 PC

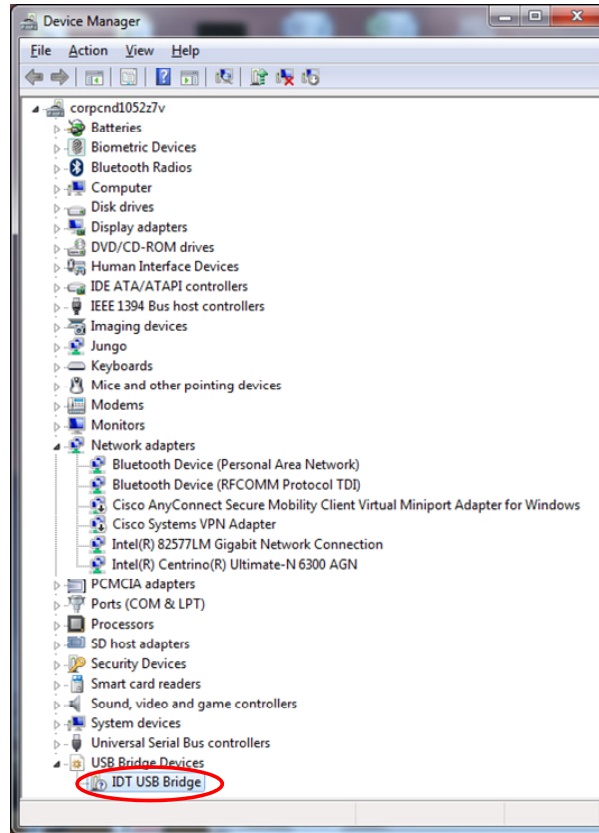

Figure 26 Checking the revision of the driver in Device Manager

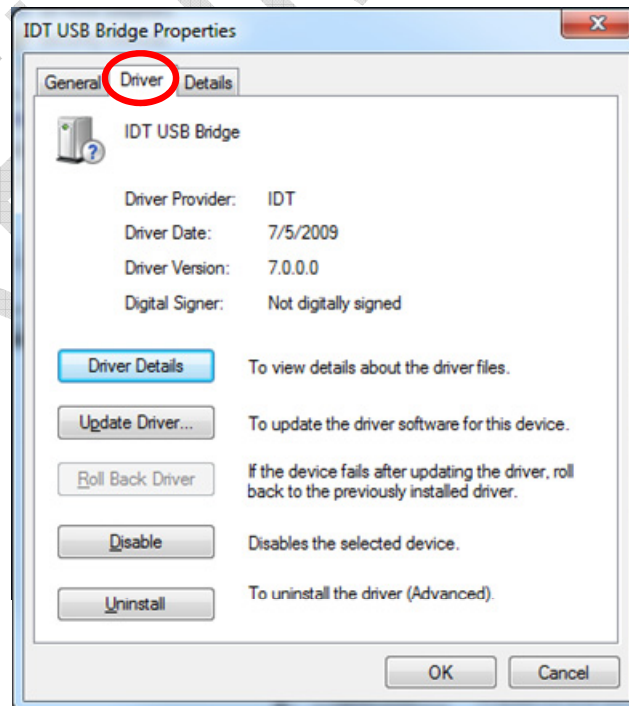

Figure 27. Checking that the revision of the driver is correct

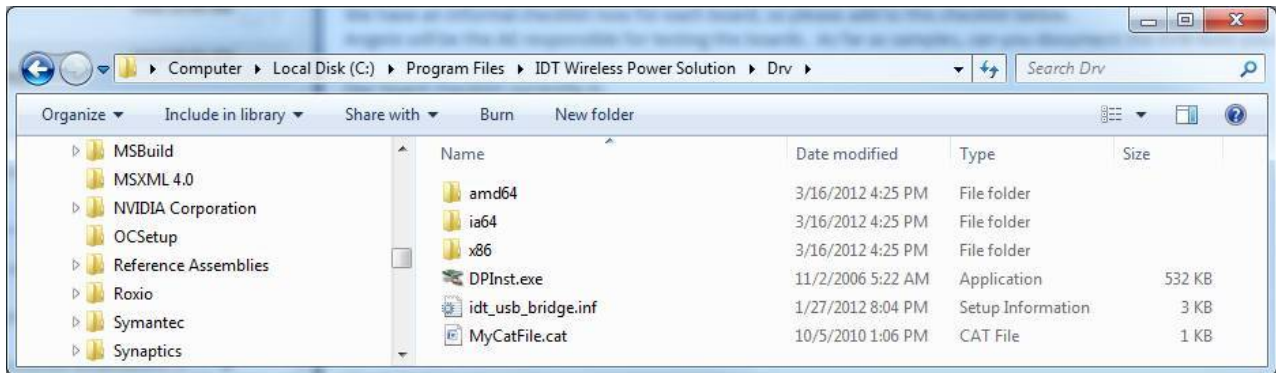

Figure 28. Installed Device Driver Directory

**Reference: Debug and Configuration Tabs**

These Tabs are for development purposes. One of the features of the Debug tab is the ability to view Real Time System Messages depending upon which of the three fields at the left of the message window is chosen. The Config and Status Tab indicate the status register readings from the device.

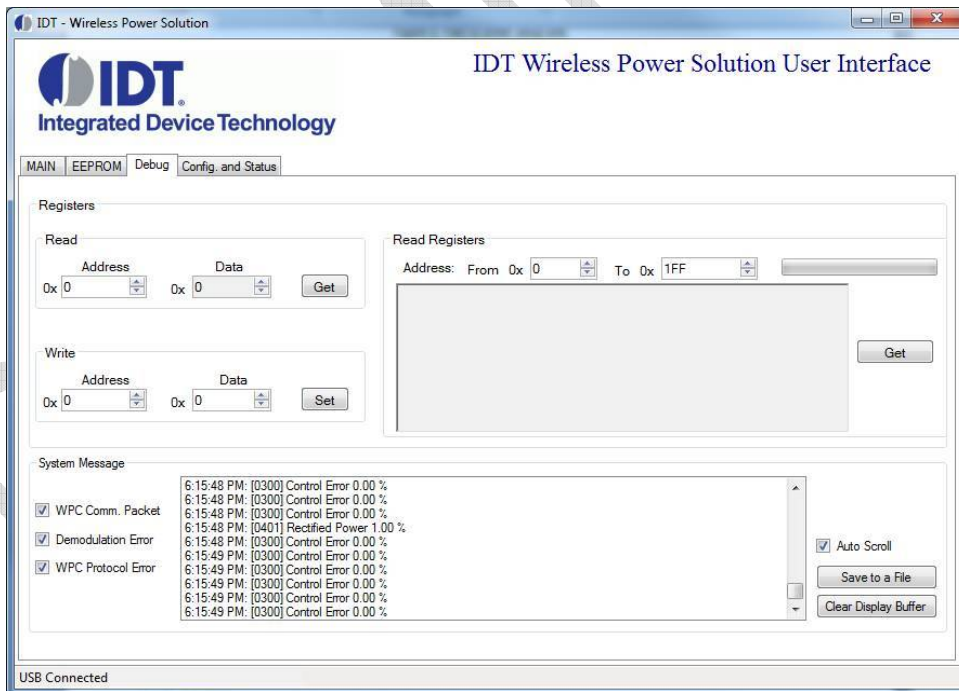

Figure 29. Debug Tab

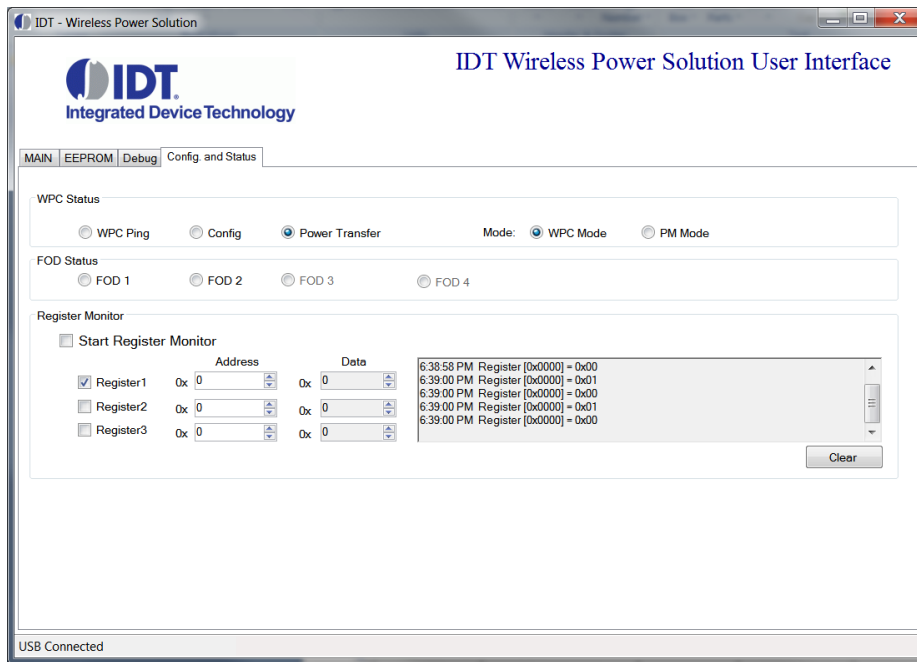

Figure 30. Configuration and Status Tab

## 4. ORDERING GUIDE

Table 3. Ordering Summary

PART NUMBER	MARKING	PRICE	AMBIENT TEMP. RANGE	SHIPPING CARRIER	QUANTITY
P9036A-FPEVK	IDTP9036A-TX-A6 EVM Rev3.2	\$149.00	0°C to +70°C	Box 14"x10"x2"	1

### Revision History

May 15, 2013 Version V1.0. Initial release.

## IMPORTANT NOTICE AND DISCLAIMER

RENESAS ELECTRONICS CORPORATION AND ITS SUBSIDIARIES (“RENESAS”) PROVIDES TECHNICAL SPECIFICATIONS AND RELIABILITY DATA (INCLUDING DATASHEETS), DESIGN RESOURCES (INCLUDING REFERENCE DESIGNS), APPLICATION OR OTHER DESIGN ADVICE, WEB TOOLS, SAFETY INFORMATION, AND OTHER RESOURCES “AS IS” AND WITH ALL FAULTS, AND DISCLAIMS ALL WARRANTIES, EXPRESS OR IMPLIED, INCLUDING, WITHOUT LIMITATION, ANY IMPLIED WARRANTIES OF MERCHANTABILITY, FITNESS FOR A PARTICULAR PURPOSE, OR NON-INFRINGEMENT OF THIRD-PARTY INTELLECTUAL PROPERTY RIGHTS.

These resources are intended for developers who are designing with Renesas products. You are solely responsible for (1) selecting the appropriate products for your application, (2) designing, validating, and testing your application, and (3) ensuring your application meets applicable standards, and any other safety, security, or other requirements. These resources are subject to change without notice. Renesas grants you permission to use these resources only to develop an application that uses Renesas products. Other reproduction or use of these resources is strictly prohibited. No license is granted to any other Renesas intellectual property or to any third-party intellectual property. Renesas disclaims responsibility for, and you will fully indemnify Renesas and its representatives against, any claims, damages, costs, losses, or liabilities arising from your use of these resources. Renesas' products are provided only subject to Renesas' Terms and Conditions of Sale or other applicable terms agreed to in writing. No use of any Renesas resources expands or otherwise alters any applicable warranties or warranty disclaimers for these products.

(Disclaimer Rev.1.01 Jan 2024)

### Corporate Headquarters

TOYOSU FORESIA, 3-2-24 Toyosu,  
Koto-ku, Tokyo 135-0061, Japan  
[www.renesas.com](http://www.renesas.com)

### Trademarks

Renesas and the Renesas logo are trademarks of Renesas Electronics Corporation. All trademarks and registered trademarks are the property of their respective owners.

### Contact Information

For further information on a product, technology, the most up-to-date version of a document, or your nearest sales office, please visit [www.renesas.com/contact-us/](http://www.renesas.com/contact-us/).