

ISL81601DEMO2Z

User's Manual: Demonstration Board

Industrial Analog and Power

All information contained in these materials, including products and product specifications, represents information on the product at the time of publication and is subject to change by Renesas Electronics Corp. without notice. Please review the latest information published by Renesas Electronics Corp. through various means, including the Renesas Electronics Corp. website (<http://www.renesas.com>).

ISL81601DEMO2Z

Demonstration Board

The ISL81601DEMO2Z demonstration board (shown in [Figure 18 on page 15](#)) features the [ISL81601](#) and [RL78G14](#). The ISL81601 is a 60V high voltage synchronous buck-boost controller. The RL78G14 is a 28 pin MCU that offers digital control and measurement for charge and discharge functions. The ISL81601DEMO2Z can adjust the input voltage and reverse current for charging, and can also adjust the output voltage and output current for discharging online. The ISL28022 is also used on this board to provide high accuracy voltage and current sensing and report to RL78 with IIC line. The ISL81601DEMO2Z can also report input and output voltage and current with high accuracy.

Key Features

- Input 0V precharge power-up
- Wide input range: 9V to 60V
- Bidirectional operation
- Output CC/CV control
- Input CC/CV control
- Online adjustable input and output setting and display using the GUI interface
- Supports prebias output with soft-start
- PGOOD indicator
- OVP, OTP, and UVP protection

Specifications

The ISL81601DEMO2Z is designed for high current applications. The current rating of the ISL81601DEMO2Z is limited by the FETs and inductor selected. The ISL81601DEMO2Z electrical ratings are shown in [Table 1](#).

Table 1. Electrical Ratings

Parameter	Rating
Input Voltage	9V to 60V
Switching Frequency	200kHz
Output Voltage	0.8V~60V
Output Current	0A~10A
OCP Set Point	1A~10A at ambient room temperature, adjustable
USB	5.5V maximum

Ordering Information

Part Number	Description
ISL81601DEMO2Z	High voltage buck-boost controller demonstration board

Related Literature

For a full list of related documents, visit our website:

- [ISL81601](#) device page

1. Functional Description

The ISL81601DEMO2Z is used for charging and discharging 12V or 48V battery systems. The board provides an easy way to adjust the charge and discharge current and voltage online.

As shown in [Figure 2 on page 5](#), the 9V to 60V power supply is connected to VIN and GND. The regulated output (0.8V~60V) on VOUT and GND can supply up to 10A to the load.

When working in Discharge mode, connect the battery or super capacitors to VIN and GND.

When working in Charge mode, connect the power supply to VOUT and GND.

As shown in [Figure 2 on page 5](#), the GUI provides:

- Selection of reverse enable and dither enable functions
- Input current and voltage (reverse) setting online
- Output current and voltage setting online

The module working conditions such as input and output voltage and current, and charging or discharging mode can be displayed using the GUI.

1.1 Recommended Testing Equipment

- 0V to 60V power supply with at least 10A source current capability
- Electronic loads capable of sinking current up to 10A
- Super capacitors or battery
- Computer with Microsoft Windows 10 operating system
- Digital Multimeters (DMMs)
- 100MHz quad-trace oscilloscope

1.2 Operating Range

The input voltage range is from 9V to 60V for an output voltage of 0.8V~60V. The minimum EN threshold is 8.5V.

Both the input and output current in charging and discharging conditions are limited to within 10A. The set point of OCP should be defined by the formulas as shown in [Equation 1](#):

$$(EQ. 1) \quad \begin{aligned} I_{in_oc_set} &\leq V_O \times 10A / V_{IN} \\ I_{out_oc_set} &\leq V_{IN} \times 10A / V_O \end{aligned}$$

That means low input voltage with high output voltage will limit the output OCP point setting $I_{out_oc_set}$, and high input voltage with low output voltage will limit the input OCP (reverse) point setting $I_{in_oc_set}$.

Note: Airflow is needed for higher than 30° ambient condition and long term full load operation.

2. Quick Start Guide

2.1 ISL81601 Charge and Discharge Test Introduction

See [Figure 2](#) for proper setup.

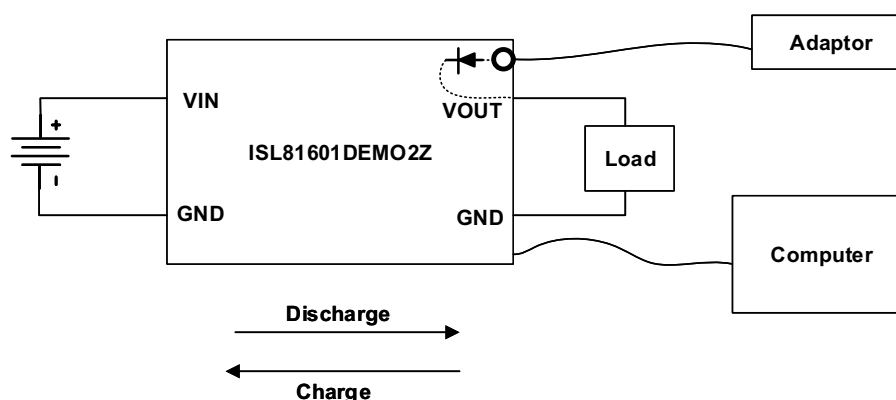
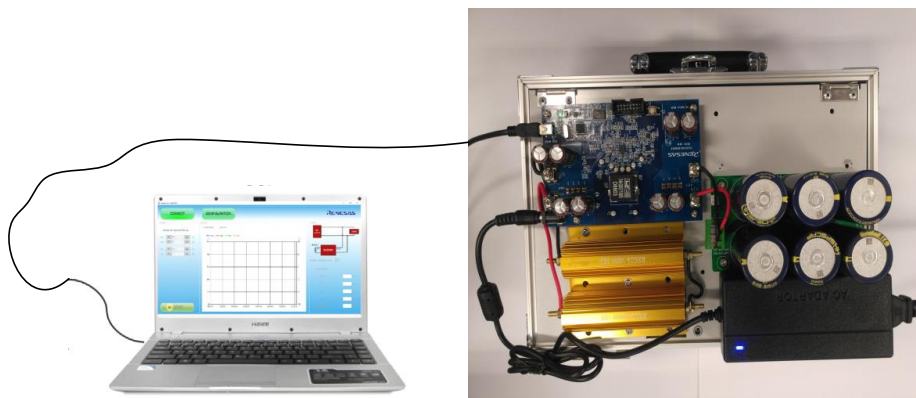

Notes:

1. Use a super capacitor pack to simulate the battery for easy domestication of the CC/CV charge and discharge performance.
2. Super capacitor pack specifications:
Capacitance: 60F
Voltage rating: 15V
Maximum continuous current: 12A

Figure 2. Proper Setup for Charge and Discharge Operation

2.2 Test Steps

When powering up for the first time, which means the super capacitor is non-charged or the voltage on the super capacitor is smaller than 10V, complete the following steps. Otherwise, when the super capacitor voltage is higher than 10V, you can jump to Step 3.

1. Click the **CONNECT** Button.

When you click the **CONNECT** button, the state window shows the current state of the demonstration board, including output voltage, input voltage, input current, output current, and ambient temperature.

Input and output voltages and currents can also be set up in Connect state on the setting area:

- Output voltage sets the discharged voltage to system and the range is from 0.8V to 60V.

- Output current sets the maximum discharge output current, which is the constant OCP point and the range is from 0A to 10A.
- Input voltage sets the charge target voltage in CV mode and the range is from 0V to 60V.
- Input current sets the charge current in CC mode and the range is from -10A to 0A.

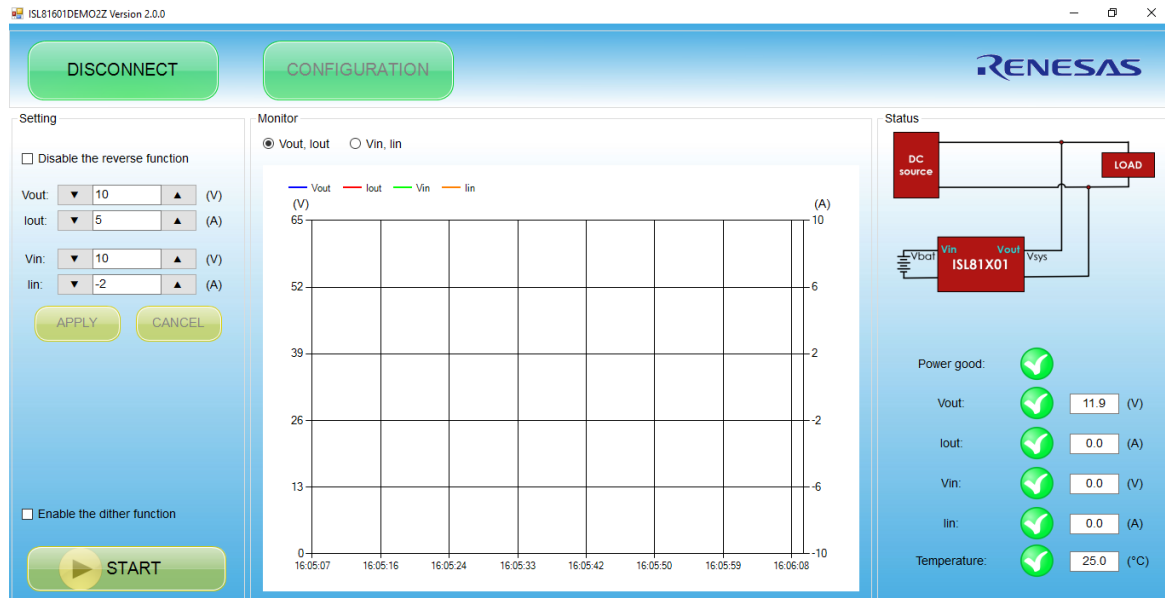

Figure 3. GUI Connecting Window

2. Precharge Process

When the super capacitor voltage is smaller than 10V before starting up, you should precharge the super capacitor to 10V first. GUI setup is as follows:

- Input voltage is set to 10V.
- Input current, which is the charge current, is set to -2A.
- Output voltage is set to $(V_{out_sense} - 2)V$. For example, when the adapter is 12V and connected to output, the output voltage should set to 10V.
- Output current is set to 5A.



Figure 4. Input Status when Precharge Starting Up in GUI

After configuration is complete, click the START button, the input voltage and current can be observed from the state table. The ISL81601DEMO2Z charges the sup-cap from the system side with CC mode, which means the charge current is 2A to the super capacitor, and the super capacitor voltage increases.

When the voltage of the super capacitor (input voltage) reaches input voltage set point 10V, the Charge mode enters CV mode, the charge current decreases, and the super capacitor voltage stays at 10V, which means precharge is complete.



Figure 5. Fully Charged Information in GUI

The waves in [Figure 6 on page 8](#) are the precharging super capacitor from 0V to 10V with 2A constant current.

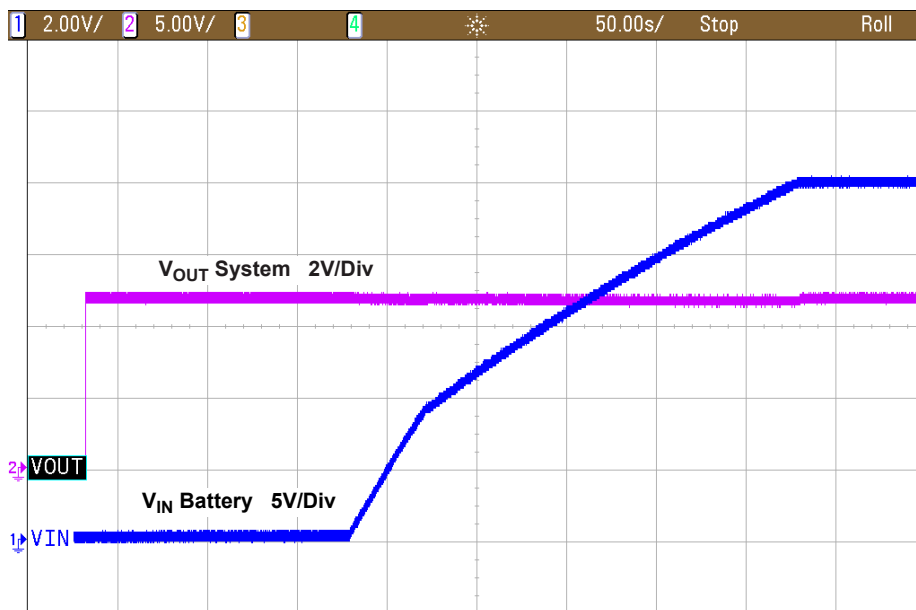

Figure 6. Input and Output Waves in Precharge Power-Up

Click **STOP** after precharge is complete.



Figure 7. Precharge Complete Information in GUI

3. Power-up at Discharge mode

When the input voltage is higher than 9V, the demonstration board can start up at Discharge mode based on the following GUI settings.

- Output voltage: 10V
- Output current: 5A
- Input voltage: 12V
- Input current: -2A
- 12V_{DC} adapter is disconnected

Note: Make sure the input voltage is set higher than battery voltage when starting up.

Click **START**, the demonstration board starts up normally, and discharges from the super capacitor to the system.

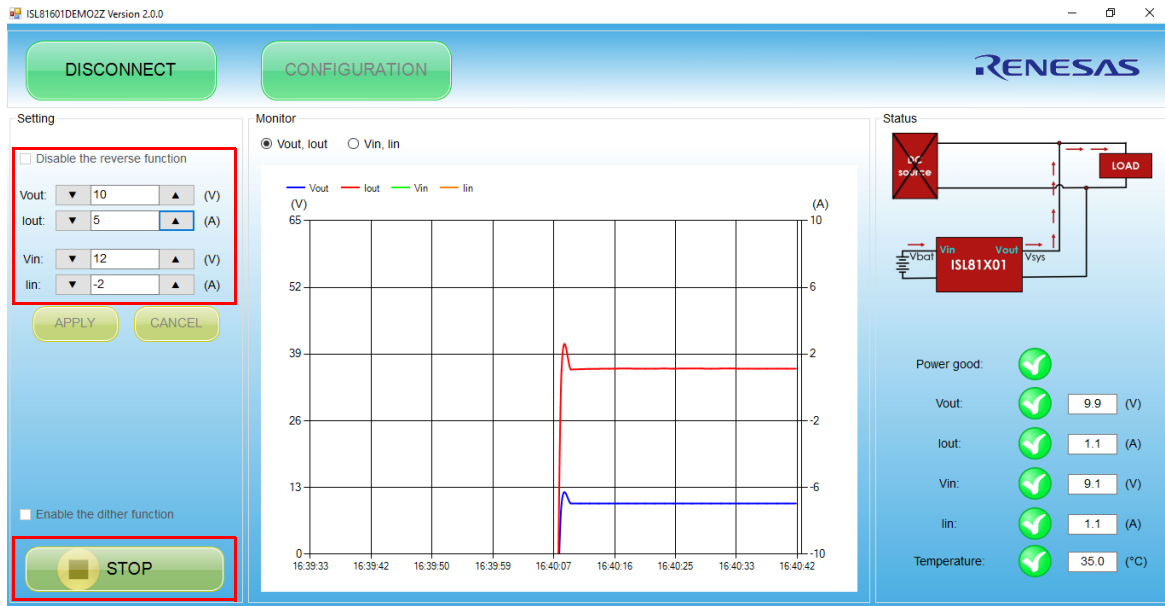

Figure 8. Starting Up at Discharge Mode in GUI

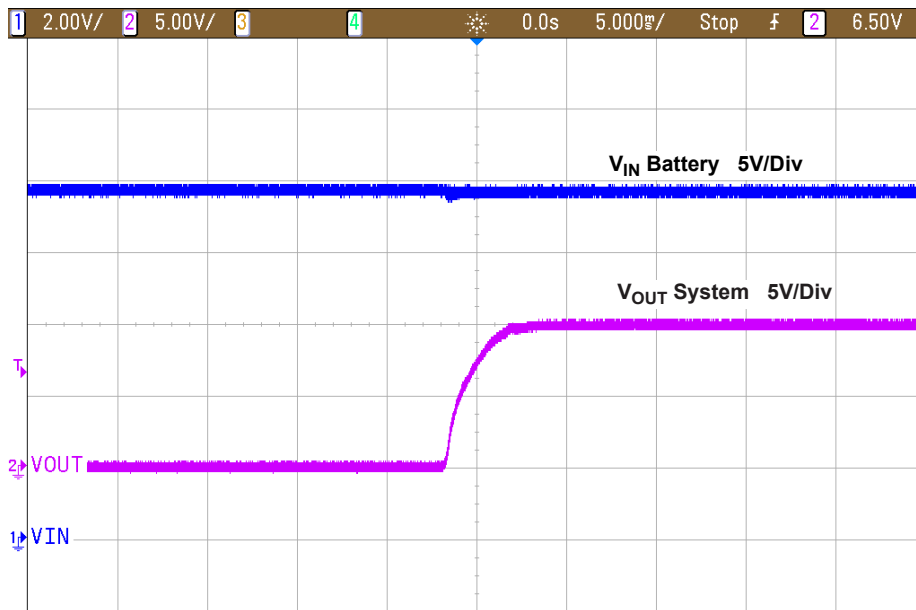

Figure 9. Input and Output Power-Up Waves

4. Charge the battery

When the voltage of the DC supply connecting to the ISL81601DEMO2Z output is higher than the set output voltage point, the board works in Charge mode, and the charge current is the value of IIN. When the demonstration board is in working state, the output supply can be connected to the output terminal directly to change the working state to Charge mode. If the board is in stop state, the charge action can also be realized by clicking the **Start** button after connecting the output power supply.

Note: The DC supply and output set point need to satisfy the following relationships at Charge mode:

- $V_{o_set} < V_{dc} < V_{o_set} + 4$

Usually $V_{o_set} = (V_{dc} - 2) V$. For example, the output voltage should be set to 10V based on a 12V DC adapter. Charge GUI settings:

- Output voltage: 10V
- Output current: 5A
- Input voltage: 12V
- Input current set: -2A
- 12V_{DC} adapter is connected



Figure 10. Mode Switching to Charging Information in GUI (Output)

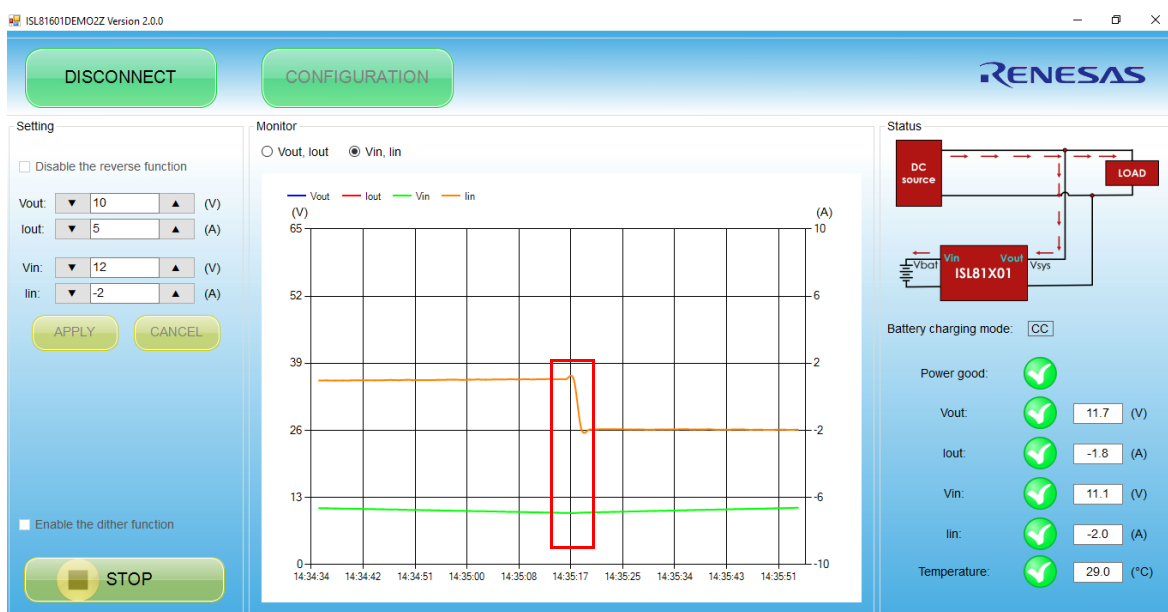

Figure 11. Mode Switching to Charging Information in GUI (Input)

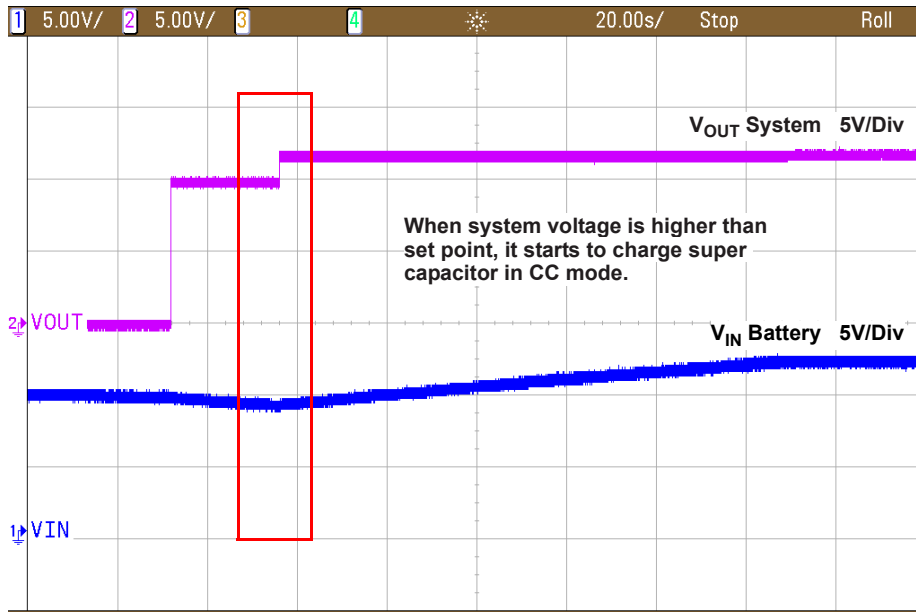

Figure 12. Input and Output Waves in Charge Mode

5. Charge complete

When the battery is fully charged, I_{OUT} changes to 0 around, V_{IN} is 12V, and I_{IN} is 0 around, which means the test is ready.



Figure 13. Fully Charging Information in GUI

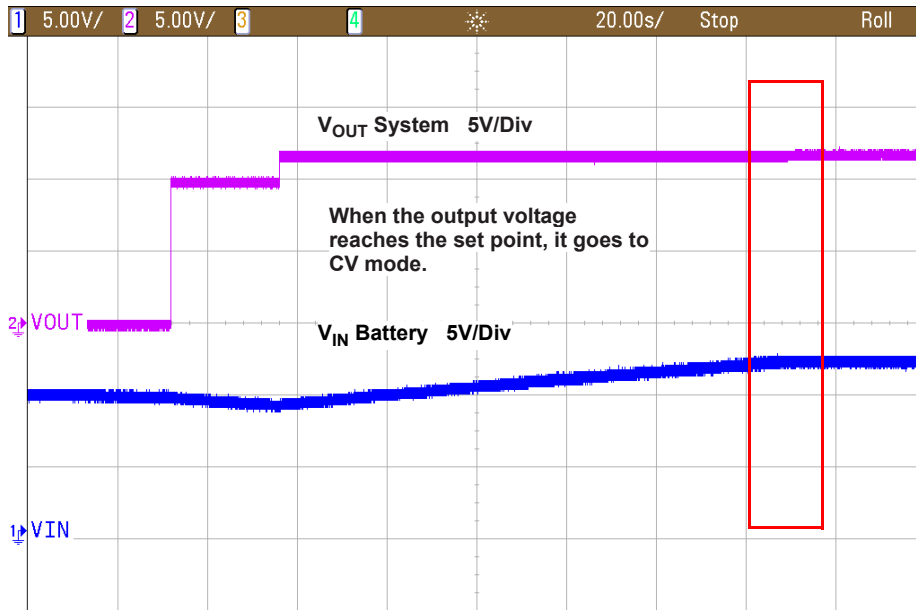

Figure 14. Fully Charging Input and Output Waves

6. Battery discharge test

Disconnect the adapter. The battery discharges energy to load.

Output current rises up to 1A, and output voltage is stable to the set point (10V). The battery voltage decreases as discharging continues.

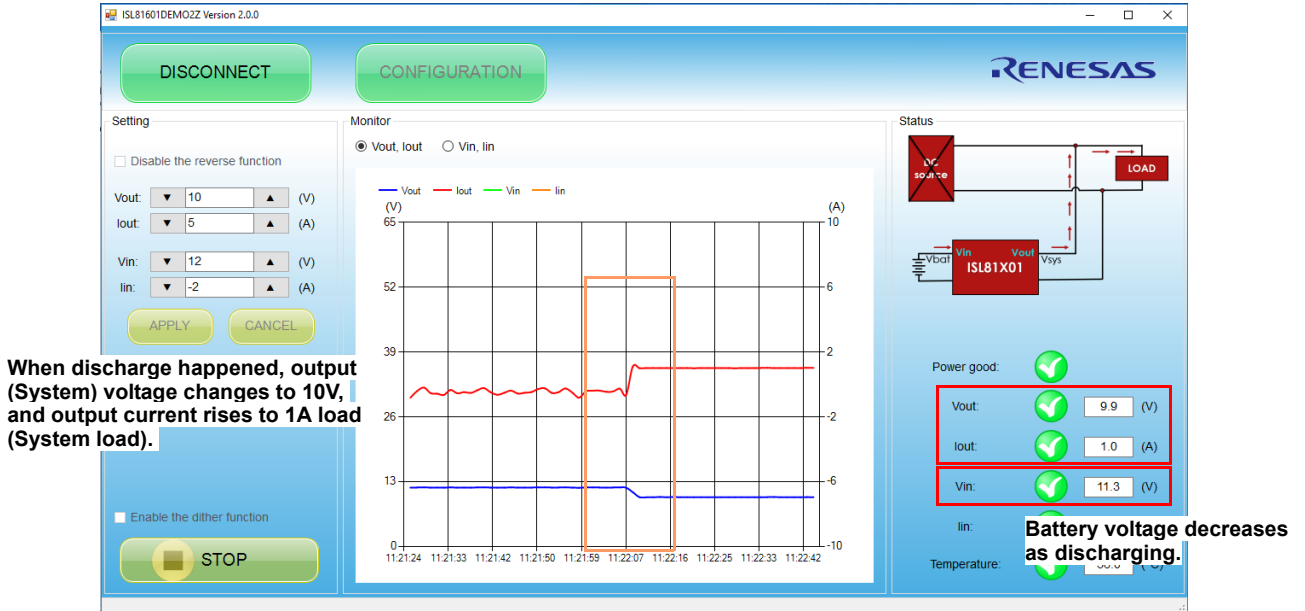

Figure 15. Discharging Information in GUI

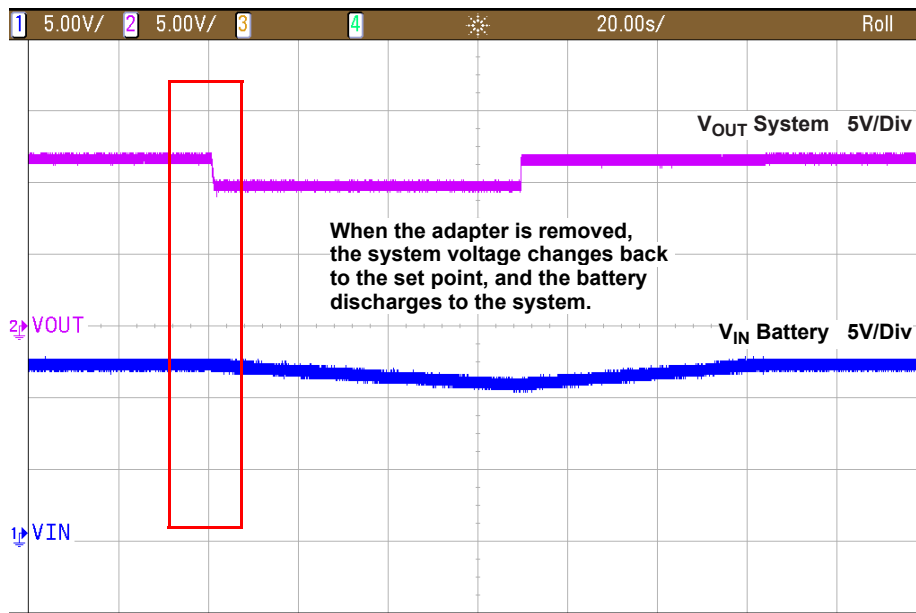

Figure 16. Input and Output Discharging Waves

2.3 Separate Test Guides

- **Disabling the Reverse Function:** If there is no charge requirement, and the input terminals (VIN, GND) are connected to the power supply, check **Disable the reverse function** (see [Figure 17](#)). When this button is checked, the input power supply voltage is not related to the input voltage set point and the output terminal should not be connected to any power supply.
- **Enabling the Frequency Dither Function:** When Frequency Dither is required, the Enable pin enables the Frequency Dither function (see [Figure 17](#)).



Figure 17. Disable Reverse Operation and Enable Dither Functions

3. PCB Layout Guidelines

Careful attention to layout requirements is necessary for successful implementation of an ISL81601 based DC/DC converter. The ISL81601 switches at a very high frequency; therefore the switching times are very short. At these switching frequencies, even the shortest trace has significant impedance. The peak gate drive current also rises significantly in an extremely short time. Transition speed of the current from one device to another causes voltage spikes across the interconnecting impedances and parasitic circuit elements. Voltage spikes can degrade efficiency, generate EMI, and increase device voltage stress and ringing. Careful component selection and proper Printed Circuit Board (PCB) layout minimizes the magnitude of voltage spikes.

Three sets of components are critical when using the ISL81601 DC/DC converter:

- Controller
- Switching power components
- Small signal components

The switching power components are the most critical to the layout because they switch a large amount of energy, which tends to generate a large amount of noise. The critical small signal components are those connected to sensitive nodes or those supplying critical bias currents. A multilayer PCB is recommended.

Complete the following steps to optimize the PCB layout.

1. Place the input capacitors, buck FETs, inductor, boost FETs, and output capacitor first. Isolate these power components on dedicated areas of the board with their ground terminals adjacent to one another. Place the input and output high frequency decoupling ceramic capacitors very close to the MOSFETs.
2. If signal components and the IC are placed separately from the power train, use full ground planes in the internal layers with shared SGND and PGND to simplify the layout design. Otherwise, use separate ground planes for the power ground and the small signal ground. Connect the SGND and PGND together close to the IC. DO NOT connect them together anywhere else.
3. The loop formed by the input capacitor, the buck top FET, and the buck bottom FET must be kept as small as possible. Also, the loop formed by the output capacitor, the boost top FET, and the boost bottom FET must also be kept as small as possible.
4. Ensure the current paths from the input capacitor to the buck FETs, the power inductor, the boost FETs, and the output capacitor are as short as possible with maximum allowable trace widths.
5. Place the PWM controller IC close to the lower FETs. The low-side FETs gate drive connections should be short and wide. Place the IC over a quiet ground area. Avoid switching ground loop currents in this area.
6. Place the VDD bypass capacitor very close to the VDD pin of the IC and connect its ground end to the PGND pin. Connect the PGND pin to the ground plane by a via. Do not connect the PGND pin directly to the SGND EPAD.
7. Place the gate drive components (BOOT diodes and BOOT capacitors) together near the controller IC.
8. Place the output capacitors as close to the load as possible. Use short, wide copper regions to connect output capacitors to the load to avoid inductance and resistance.
9. Use copper filled polygons or wide, short traces to connect the junction of the buck or boost upper FET, buck or boost lower FET, and output inductor. Keep the buck and boost PHASE nodes connection to the IC short. DO NOT unnecessarily oversize the copper islands for the PHASE nodes. Because the phase nodes are subjected to very high dv/dt voltages, the stray capacitors formed between these islands and the surrounding circuitry can couple switching noise.
10. Route all high speed switching nodes away from the control circuitry.
11. Create a separate small analog ground plane near the IC. Connect the SGND pin to this plane. All small signal grounding paths including feedback resistors, current monitoring resistors and capacitors, soft-starting capacitors, loop compensation capacitors and resistors, and EN pull-down resistors should be connected to this SGND plane.

12. Use a pair of traces with minimum loop for the input or output current sensing connection.
13. Ensure the feedback connection to the output capacitor is short and direct.

3.1 ISL81601DEMO2Z Demo Board

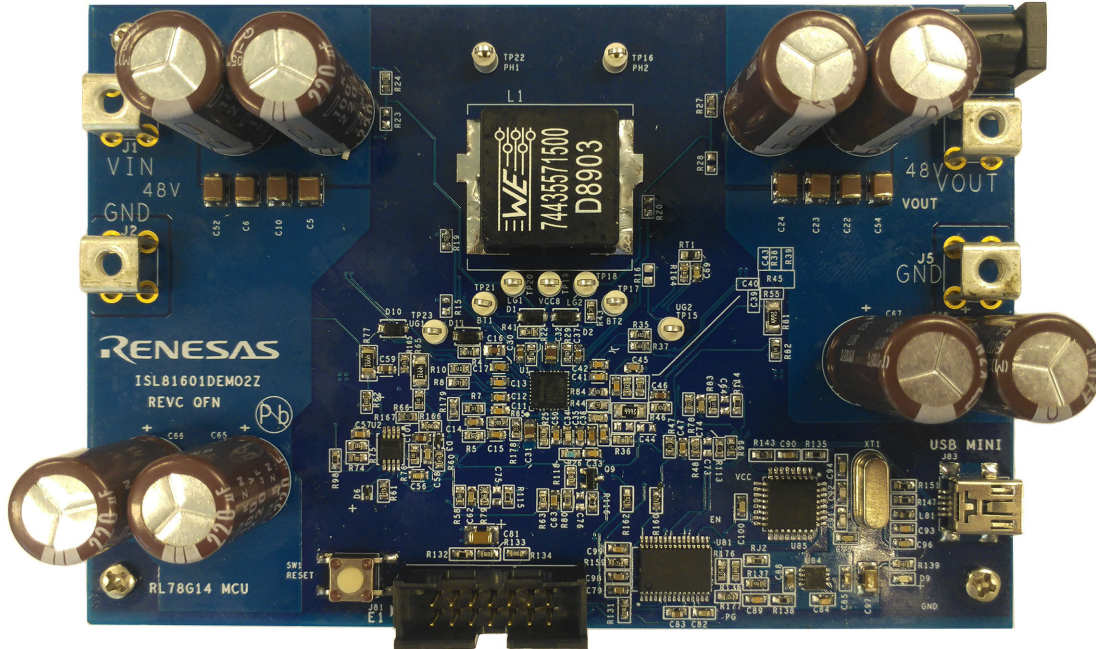

Figure 18. ISL81601DEMO2Z Demonstration Board (Top)

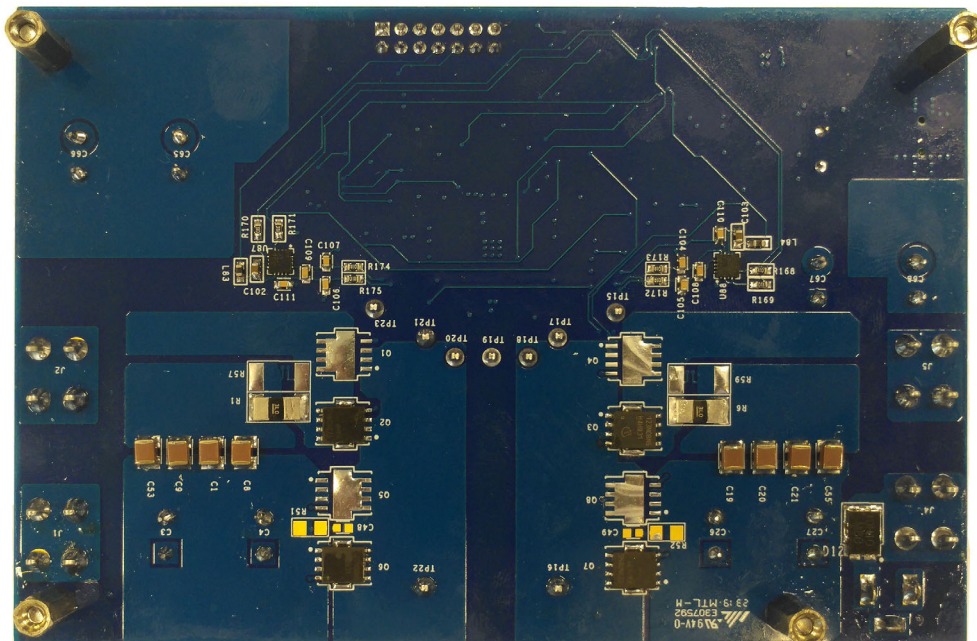

Figure 19. ISL81601DEMO2Z Demonstration Board (Bottom)

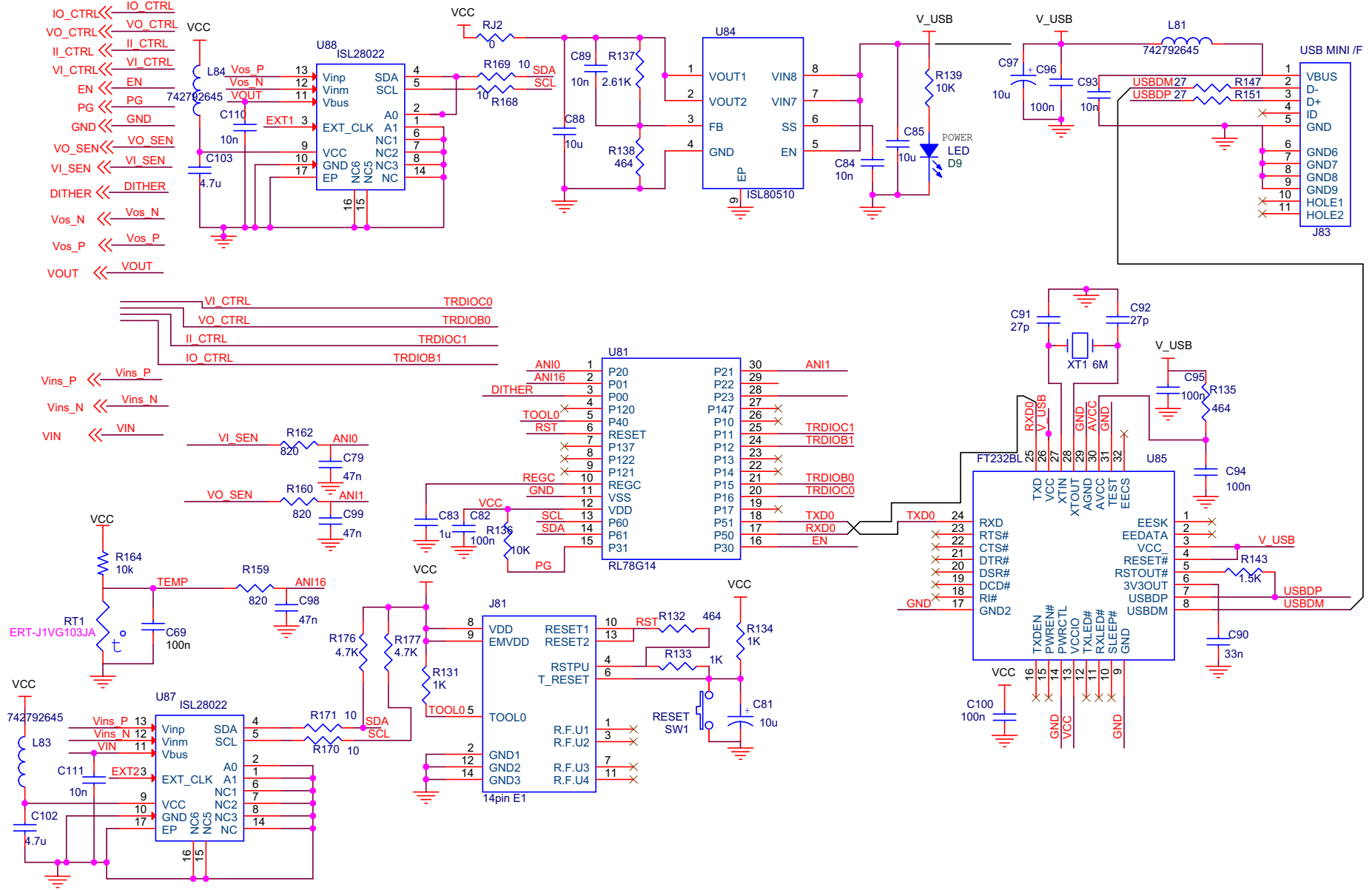

Figure 21. RL78G14 Schematic

3.3 Bill of Materials

Qty	Reference	Description	Manufacturer Part	Manufacturer
16	C1, C5, C6, C8, C9, C10, C19, C20, C21, C22, C23, C24, C52, C53, C54, C55	4.7 μ	CGA6M3X7S2A475K200AB	Murata
4	C3, C4, C65, C66	220 μ	EKZN101ELL221MK25S	UCC
3	C11, C15, C43	1n	C1608X7R1H102K080AE	TDK
15	C12, C13, C41, C42, C84, C89, C93, C104, C105, C106, C107, C108, C109, C110, C111	10n	C1608X7R2A102K080AA	TDK
2	C14, C45	47n	CGJ3E2X7R1E473K080AA	TDK
1	C16	100n	C2012X7R2A104K125AA	TDK
4	C26, C27, C67, C68	220 μ	EKZN101ELL221MK25S	Panasonic
2	C30, C37	0.47 μ	GRM188R71E474KA12D	Murata
2	C31, C32	10 μ	GRM21BC71C106KE11L	Murata
1	C33	10n	CGA3E2X7R1H103K080AE	TDK
1	C34	820p	GRM188R71H821KA01D	Murata
1	C35	47n	CGJ3E2X7R1E473K080AA	Yageo
1	C36	33n	CGJ3E2X7R1E333K080AA	TDK
1	C39	22n	CGJ3E2X7R1E223K080AA	TDK
1	C40	220p	GRM188R71H221KA01D	Murata
1	C46	100n	CC0603KRX7R9BB104	Yageo
2	C47, C63	330n	CC0603KRX7R7BB334	Yageo
1	C50	1n	C1608X7R1H102K080AE	Yageo
3	C56, C58, C62	100n	CC0603KRX7R9BB104	Yageo
2	C57, C90	33n	CC0603KRX7R9BB333	Yageo
1	C59	47p	AC0603JRNPO0BN470	Yageo
6	C69, C82, C94, C95, C96, C100	100n	CC0603KPX7R7BB104	Yageo
1	C74	100n	CC0603KRX7R9BB104	Yageo
3	C79, C98, C99	47n	CX0603MRX7R7BB473	Yageo
2	C81, C97	10 μ	GCJ31CR71A106KA13L	Murata
1	C83	1 μ	CC0603KRX7R7BB105	Yageo
2	C85, C88	10 μ	CL10B106MQ8NRNC	Samsung Electro-Mechanics
2	C91, C92	27p	C0603C270J5RAC7867	Kemet
1	C101	10n	C1608X7R2A103M080AA	TDK
2	C102, C103	4.7 μ	CC0603MRX7R5BB475	Yageo
4	D1, D2, D10, D11	100V	MBR1H100SFT3G	ON
2	D3, D6	30V	BAT54WX-TP	MCC
1	D9	LED	150060GS75020	Wurth
1	D12	Diode 277A	SS10PH10-M3/86A	Vishay Semiconductor Diodes Division
4	J1, J2, J4, J5	TE	7795	Keystone
1	J81	14pin E1	5103308-2	TE Connectivity

Qty	Reference	Description	Manufacturer Part	Manufacturer
1	J83	USB MINI /F	USB MINI /F	
1	J84	12V Connector	PJ-002B	CUI Inc
1	L1	15u	74435571500	Würth
3	L81, L83, L84	742792645	742792645	Würth
2	Q2, Q3, Q6, Q7	BSC123N08NS3	BSC123N08NS3	Infineon
3	RJ2, R115, R116	0	RC0603JR-070RL	Yageo
1	RT1	ERT-J1VG103JA	ERT-J1VG103JA	Panasonic
2	R1, R6	3m	WSL25123L000FEA	Riedon
5	R4, R168, R169, R170, R171	10	RC0603FR-0710RL	Yageo
2	R5, R38	5.1k	RC0603FR-075K1L	Yageo
1	R7	42.2k	RT0603BRD0742K2L	Yageo
4	R8, R10, R35, R37	1	RC0603FR-071RL	Yageo
3	R19, R20, R29	2.2	AC0603JR-072R2L	Vishay
1	R22	2.2	AC0603JR-072R2L	Yageo
2	R24, R27	2.2	AC0603JR-072R2L	Yageo
1	R25	196k	RC0603FR-07196K	Yageo
1	R26	2.7k	RC0603FR-072K7L	Yageo
1	R28	DNP	AC0603JR-072R2L	Yageo
2	R36, R118	10k	RC0603FR-0710KL	Yageo
1	R39	47.5k	RC0603FR-0747K5L	Yageo
2	R41, R178	15k	ERA-3AEB153V	Panasonic
1	R43	15k	ERA-3AEB153V	Panasonic
1	R44	6.49k	ERA-3AEB6491V	Panasonic
4	R45, R65, R77, R81	499k	RT1206DRD07499KL	Yageo
3	R46, R84, R85	20	RC0603JR-0720RL	Yageo
1	R47	18.2k	ERA-3AEB1822V	Panasonic
1	R48	1.82k	RC0603FR-071K82L	Yageo
1	R58	316k	RC0603FR-07316KL	Yageo
3	R60, R61, R165	51k	RT0603DRD0751KL	Yageo
1	R62	6.65k	ERA-3AEB6651V	Panasonic
1	R63	18.2k	ERA-3AEB1822V	Yageo
2	R66, R82	21.0k	RT0603DRD0721KL	Yageo
1	R74	523k	RC0603FR-07523KL	Yageo
1	R75	100k	RT0603BRD07100KL	Yageo
1	R76	20k	ERA-3AEB203V	Panasonic
1	R78	332k	RT0603BRD07332KL	Yageo
1	R79	31.6k	RC0603FR-0731K6L	Yageo
2	R80, R179	1.82k	RC0603FR-071K82L	Yageo
1	R83	33.2k	RC0603FR-0733K2L	Yageo
3	R17, R98, R113, R114	0	RC0603JR-070RL	Yageo
1	R99	21.0k	RT0603DRD0721KL	Yageo

Qty	Reference	Description	Manufacturer Part	Manufacturer
3	R131, R133, R134	1K	RT0603DRD071KL	Yageo
3	R132, R135, R138	464	ERA-3AEB4640V	Panasonic
3	R136, R139, R164	10k	RT0603DRD0710KL	Yageo
1	R137	2.61k	ERA-3AEB2611V	Panasonic
1	R143	1.5k	RC0603FR-071K5L	Yageo
2	R147, R151	27	RC0603JR-0727RL	Yageo
3	R159, R160, R162	820	RT0603BRD07820RL	Yageo
1	R166	1k	ERA-3AEB102V	Panasonic
1	R167	3.9k	ERA-3AEB392V	Panasonic
4	R172, R173, R174, R175	100	ERA-3AEB101V	Panasonic
2	R176, R177	4.7k	RC0603JR-074K7L	Yageo
1	SW1	RESET	FSM2JSMAATR	TE Connectivity
9	TP15, TP16, TP17, TP18, TP19, TP20, TP21, TP22, TP23	CON1	5007	Keystone Electronics
1	U1	ISL81601	ISL81601FRZ	Renesas
1	U2	ISL28213	ISL28213FUZ	Renesas
1	U81	RL78G14	R5F104AGASP	Renesas
1	U84	ISL80510	ISL80510IRAJZ-T7A	Renesas
1	U85	FT232BL	FT232BL-REEL	FTDI
2	U87, U88	ISL28022	ISL28022FRZ-T	Renesas
1	XT1	6M	ATS060	CTS-Frequency Controls

3.4 Board Layout

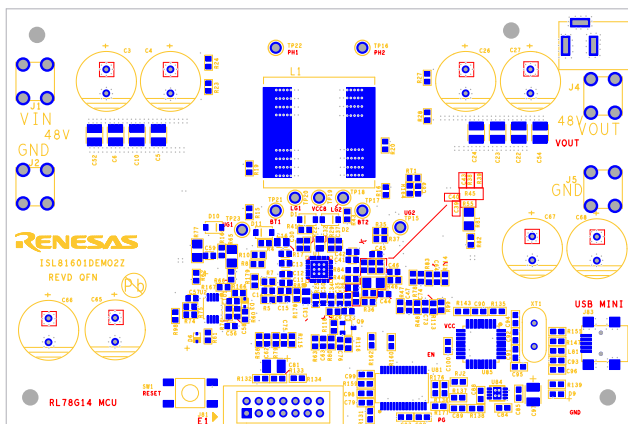

Figure 22. Silkscreen Top

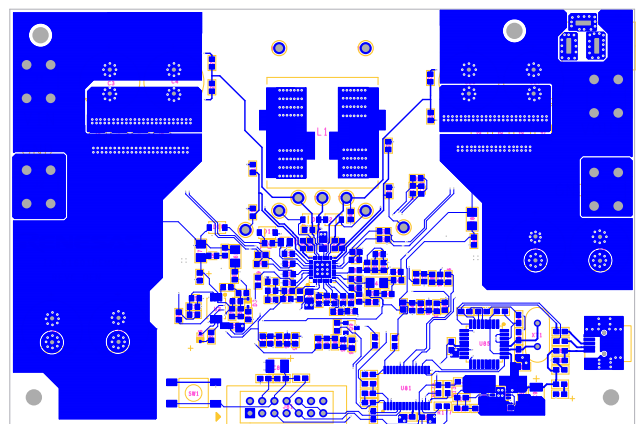

Figure 23. Top Layer

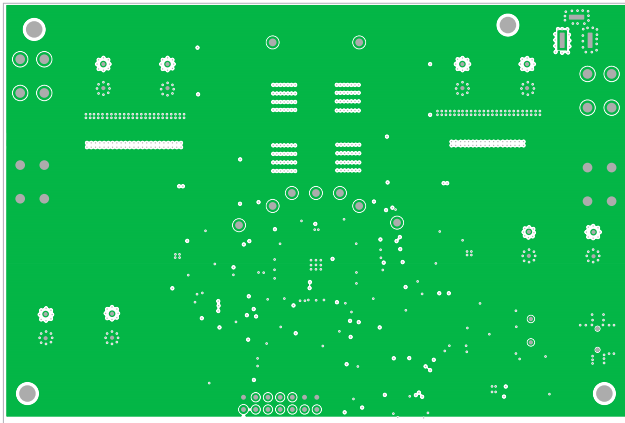

Figure 24. Second Layer (Solid Ground)

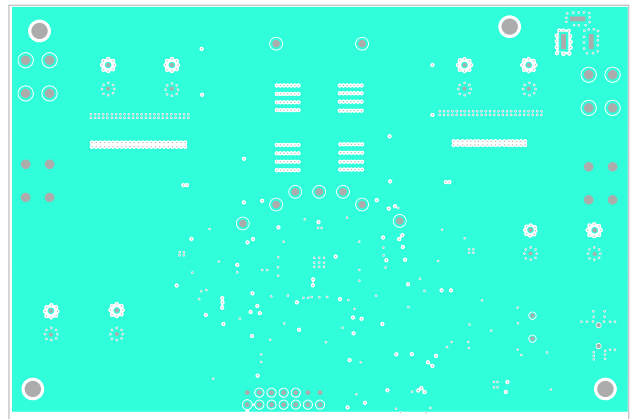

Figure 25. Third Layer

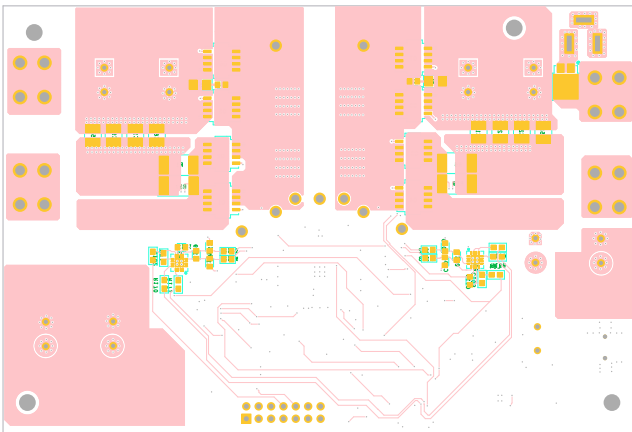

Figure 26. Bottom Layer

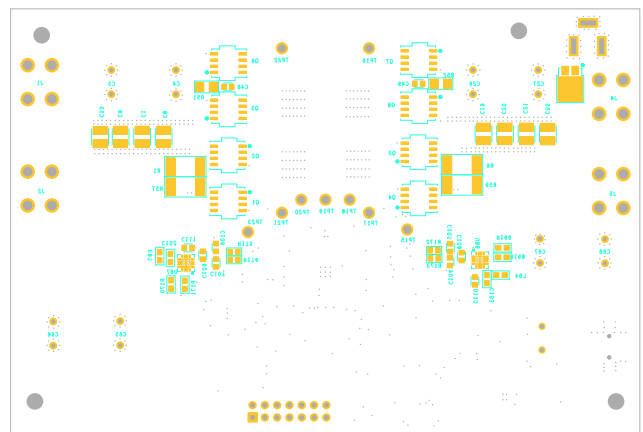

Figure 27. Silkscreen Bottom

4. Typical Performance Curves

$V_{IN} = 48V$, unless otherwise noted.

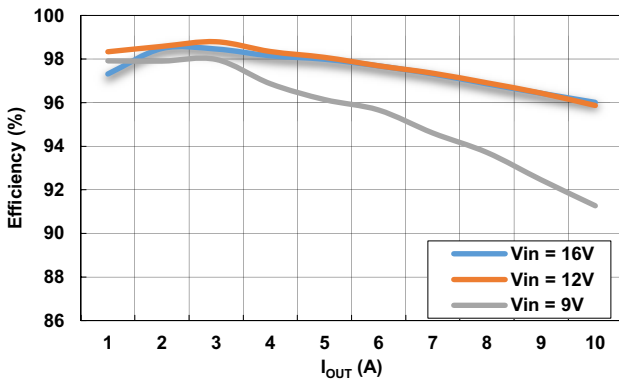

Figure 28. Efficiency, 12V

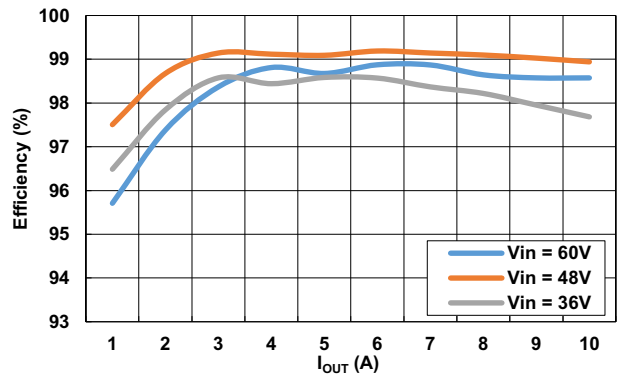

Figure 29. Efficiency, 48V

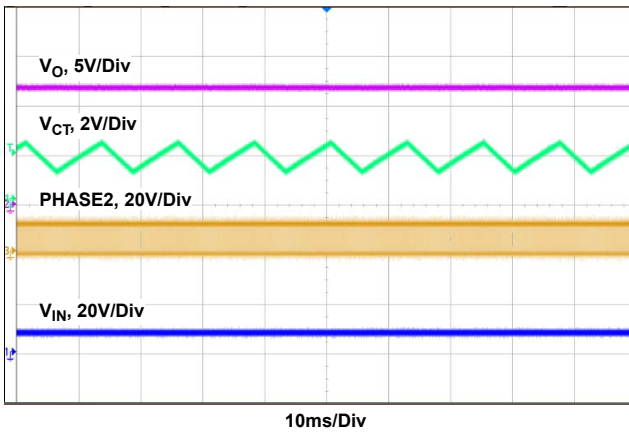

Figure 30. Dither V_{IN} , V_O , V_{CT} (CLKOUT/DITHER pin voltage), $V_{IN} = 10V$, $V_O = 12V$, $I_{OUT} = 5A$

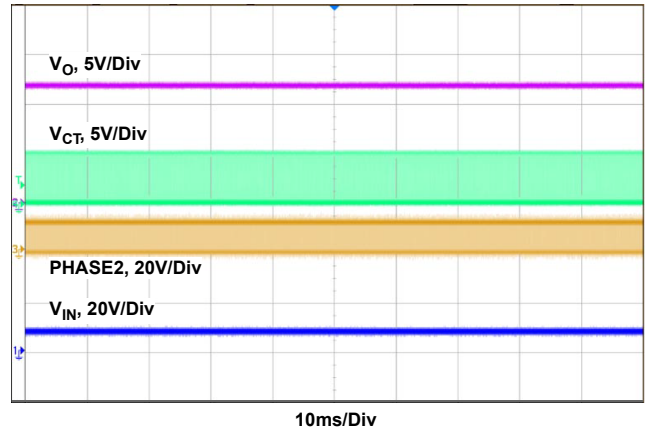

Figure 31. Normal V_{IN} , V_O , V_{CT} (CLKOUT/DITHER pin voltage), $V_{IN} = 10V$, $V_O = 12V$, $I_{OUT} = 5A$

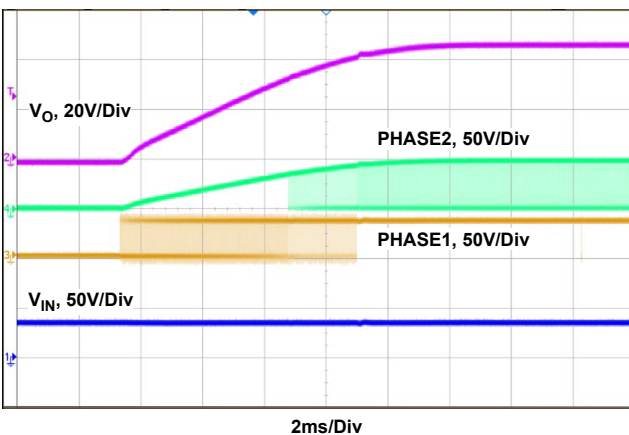

Figure 32. Start-Up Waveform, $V_{IN} = 36V$, $V_{OUT} = 48V$, $I_{OUT} = 2A$, CCM

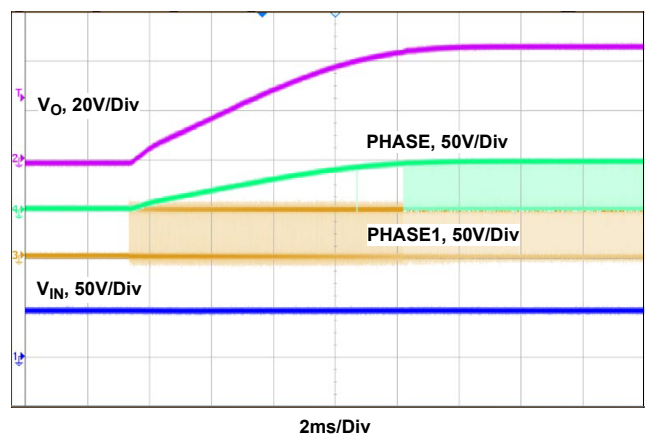

Figure 33. Start-Up Waveform, $V_{IN} = 48V$, $V_{OUT} = 48V$, $I_{OUT} = 2A$, CCM

$V_{IN} = 48V$, unless otherwise noted. (Continued)

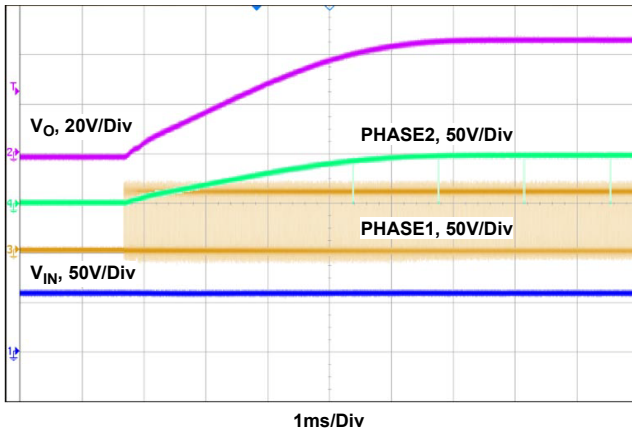

Figure 34. Start-Up Waveform, $V_{IN} = 60V$, $V_{OUT} = 48V$, $I_{OUT} = 2A$, CCM

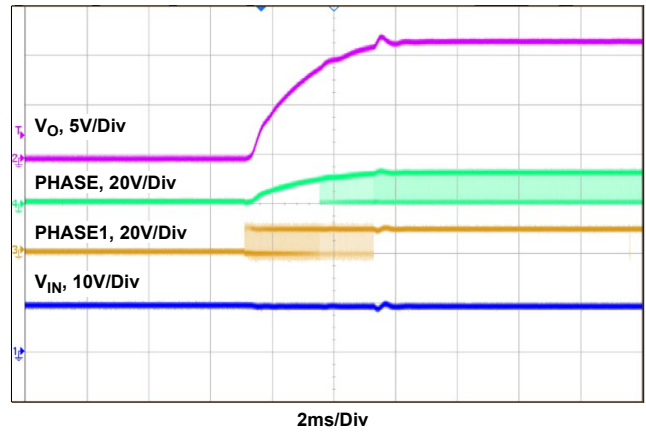

Figure 35. Start-Up Waveform, $V_{IN} = 10V$, $V_{OUT} = 12V$, $I_{OUT} = 5A$, CCM

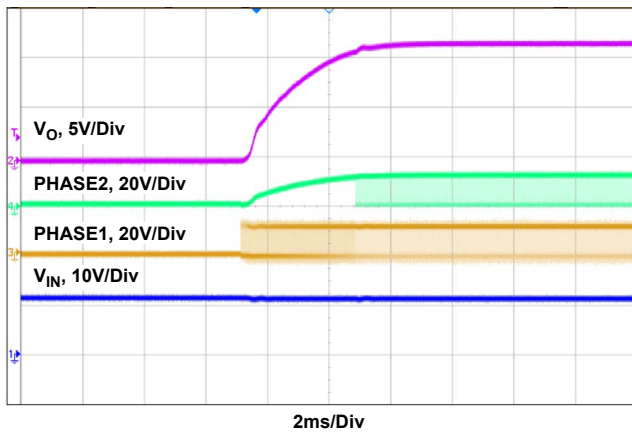

Figure 36. Start-Up Waveform, $V_{IN} = 12V$, $V_{OUT} = 12V$, $I_{OUT} = 5A$, CCM

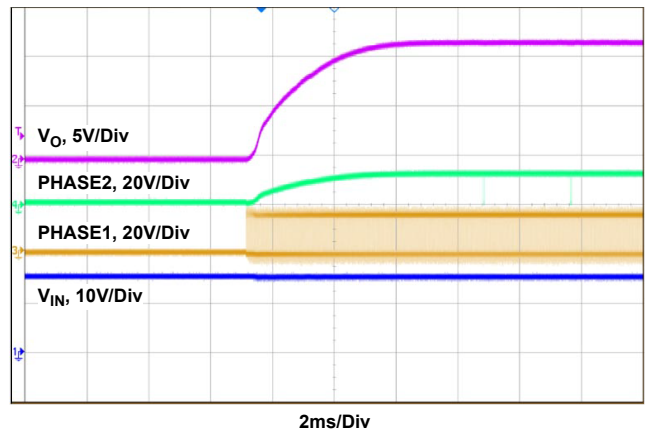

Figure 37. Start-Up Waveform, $V_{IN} = 16V$, $V_{OUT} = 12V$, $I_{OUT} = 5A$, CCM

5. Revision

Rev.	Date	Description
1.00	Oct.16.19	Applied new formatting. Updated links throughout. Added new feature bullet (pre-charge function) Updated Quick Start Guide Improved current and voltage accuracy Updated schematics Updated the Bill of Materials Updated board layout figures Updated disclaimer
0.00	Oct.15.18	Initial release

General Precautions in the Handling of Microprocessing Unit and Microcontroller Unit Products

The following usage notes are applicable to all Microprocessing unit and Microcontroller unit products from Renesas. For detailed usage notes on the products covered by this document, refer to the relevant sections of the document as well as any technical updates that have been issued for the products.

1. Handling of Unused Pins

Handle unused pins in accordance with the directions given under Handling of Unused Pins in the manual.

- The input pins of CMOS products are generally in the high-impedance state. In operation with an unused pin in the open-circuit state, extra electromagnetic noise is induced in the vicinity of LSI, an associated shoot-through current flows internally, and malfunctions occur due to the false recognition of the pin state as an input signal become possible. Unused pins should be handled as described under Handling of Unused Pins in the manual.

2. Processing at Power-on

The state of the product is undefined at the moment when power is supplied.

- The states of internal circuits in the LSI are indeterminate and the states of register settings and pins are undefined at the moment when power is supplied.

In a finished product where the reset signal is applied to the external reset pin, the states of pins are not guaranteed from the moment when power is supplied until the reset process is completed.

In a similar way, the states of pins in a product that is reset by an on-chip power-on reset function are not guaranteed from the moment when power is supplied until the power reaches the level at which resetting has been specified.

3. Prohibition of Access to Reserved Addresses

Access to reserved addresses is prohibited.

- The reserved addresses are provided for the possible future expansion of functions. Do not access these addresses; the correct operation of LSI is not guaranteed if they are accessed.

4. Clock Signals

After applying a reset, only release the reset line after the operating clock signal has become stable. When switching the clock signal during program execution, wait until the target clock signal has stabilized.

- When the clock signal is generated with an external resonator (or from an external oscillator) during a reset, ensure that the reset line is only released after full stabilization of the clock signal. Moreover, when switching to a clock signal produced with an external resonator (or by an external oscillator) while program execution is in progress, wait until the target clock signal is stable.

5. Differences between Products

Before changing from one product to another, i.e. to a product with a different part number, confirm that the change will not lead to problems.

- The characteristics of Microprocessing unit or Microcontroller unit products in the same group but having a different part number may differ in terms of the internal memory capacity, layout pattern, and other factors, which can affect the ranges of electrical characteristics, such as characteristic values, operating margins, immunity to noise, and amount of radiated noise. When changing to a product with a different part number, implement a system-evaluation test for the given product.

Notice

1. Descriptions of circuits, software and other related information in this document are provided only to illustrate the operation of semiconductor products and application examples. You are fully responsible for the incorporation or any other use of the circuits, software, and information in the design of your product or system. Renesas Electronics disclaims any and all liability for any losses and damages incurred by you or third parties arising from the use of these circuits, software, or information.
2. Renesas Electronics hereby expressly disclaims any warranties against and liability for infringement or any other claims involving patents, copyrights, or other intellectual property rights of third parties, by or arising from the use of Renesas Electronics products or technical information described in this document, including but not limited to, the product data, drawings, charts, programs, algorithms, and application examples.
3. No license, express, implied or otherwise, is granted hereby under any patents, copyrights or other intellectual property rights of Renesas Electronics or others.
4. You shall not alter, modify, copy, or reverse engineer any Renesas Electronics product, whether in whole or in part. Renesas Electronics disclaims any and all liability for any losses or damages incurred by you or third parties arising from such alteration, modification, copying or reverse engineering.
5. Renesas Electronics products are classified according to the following two quality grades: "Standard" and "High Quality". The intended applications for each Renesas Electronics product depends on the product's quality grade, as indicated below.
 - "Standard": Computers; office equipment; communications equipment; test and measurement equipment; audio and visual equipment; home electronic appliances; machine tools; personal electronic equipment; industrial robots; etc.
 - "High Quality": Transportation equipment (automobiles, trains, ships, etc.); traffic control (traffic lights); large-scale communication equipment; key financial terminal systems; safety control equipment; etc.Unless expressly designated as a high reliability product or a product for harsh environments in a Renesas Electronics data sheet or other Renesas Electronics document, Renesas Electronics products are not intended or authorized for use in products or systems that may pose a direct threat to human life or bodily injury (artificial life support devices or systems; surgical implantations; etc.), or may cause serious property damage (space system; undersea repeaters; nuclear power control systems; aircraft control systems; key plant systems; military equipment; etc.). Renesas Electronics disclaims any and all liability for any damages or losses incurred by you or any third parties arising from the use of any Renesas Electronics product that is inconsistent with any Renesas Electronics data sheet, user's manual or other Renesas Electronics document.
6. When using Renesas Electronics products, refer to the latest product information (data sheets, user's manuals, application notes, "General Notes for Handling and Using Semiconductor Devices" in the reliability handbook, etc.), and ensure that usage conditions are within the ranges specified by Renesas Electronics with respect to maximum ratings, operating power supply voltage range, heat dissipation characteristics, installation, etc. Renesas Electronics disclaims any and all liability for any malfunctions, failure or accident arising out of the use of Renesas Electronics products outside of such specified ranges.
7. Although Renesas Electronics endeavors to improve the quality and reliability of Renesas Electronics products, semiconductor products have specific characteristics, such as the occurrence of failure at a certain rate and malfunctions under certain use conditions. Unless designated as a high reliability product or a product for harsh environments in a Renesas Electronics data sheet or other Renesas Electronics document, Renesas Electronics products are not subject to radiation resistance design. You are responsible for implementing safety measures to guard against the possibility of bodily injury, injury or damage caused by fire, and/or danger to the public in the event of a failure or malfunction of Renesas Electronics products, such as safety design for hardware and software, including but not limited to redundancy, fire control and malfunction prevention, appropriate treatment for aging degradation or any other appropriate measures. Because the evaluation of microcomputer software alone is very difficult and impractical, you are responsible for evaluating the safety of the final products or systems manufactured by you.
8. Please contact a Renesas Electronics sales office for details as to environmental matters such as the environmental compatibility of each Renesas Electronics product. You are responsible for carefully and sufficiently investigating applicable laws and regulations that regulate the inclusion or use of controlled substances, including without limitation, the EU RoHS Directive, and using Renesas Electronics products in compliance with all these applicable laws and regulations. Renesas Electronics disclaims any and all liability for damages or losses occurring as a result of your noncompliance with applicable laws and regulations.
9. Renesas Electronics products and technologies shall not be used for or incorporated into any products or systems whose manufacture, use, or sale is prohibited under any applicable domestic or foreign laws or regulations. You shall comply with any applicable export control laws and regulations promulgated and administered by the governments of any countries asserting jurisdiction over the parties or transactions.
10. It is the responsibility of the buyer or distributor of Renesas Electronics products, or any other party who distributes, disposes of, or otherwise sells or transfers the product to a third party, to notify such third party in advance of the contents and conditions set forth in this document.
11. This document shall not be reprinted, reproduced or duplicated in any form, in whole or in part, without prior written consent of Renesas Electronics.
12. Please contact a Renesas Electronics sales office if you have any questions regarding the information contained in this document or Renesas Electronics products.

(Note1) "Renesas Electronics" as used in this document means Renesas Electronics Corporation and also includes its directly or indirectly controlled subsidiaries.

(Note2) "Renesas Electronics product(s)" means any product developed or manufactured by or for Renesas Electronics.

(Rev.4.0-1 November 2017)

Corporate Headquarters

TOYOSU FORESIA, 3-2-24 Toyosu,
Koto-ku, Tokyo 135-0061, Japan
www.renesas.com

Contact Information

For further information on a product, technology, the most up-to-date version of a document, or your nearest sales office, please visit:
www.renesas.com/contact/

Trademarks

Renesas and the Renesas logo are trademarks of Renesas Electronics Corporation. All trademarks and registered trademarks are the property of their respective owners.

ISL81601DEMO2Z