

RA9530-R

Evaluation Kit

The RA9530-R-EVK Wireless Power Evaluation Board can demonstrate the features and performance of the RA9530 Wireless Power Receiver with WattShare™ mode. The board comes with pre-programmed reference firmware in which GPIOs are configured for specific functions that meet broader customer requirements.

The RA9530 features Multiple-Time Programmable (MTP) non-volatile memory that enables customers to customize the design parameters such as default output voltage and FOD thresholds. The RA9530 includes over-temperature and voltage protection. Fault conditions associated with power transfer are managed by an industry-leading 32-bit ARM® Cortex®-M0 processor offering a high level of programmability while consuming low standby power. The RA9530 Windows Graphical User Interface (GUI) can be used to configure the design parameters, monitor operating parameters such as Rectifier voltage, and program the new configuration into the RA9530.

The RA9530-R-EVK is designed for evaluation purposes only. It must not be used for module or mass production purposes.

Evaluation Kit Contents

- RA9530-R Demo Board assembled with coil

Features

- Delivers up to 30W of power in Renesas high power mode when paired with P9247-GB-EVK
- ±1.5% accurate output current sensing for robust FOD detection
- WattShare™ TRx mode with up to 10W Tx capability
- Supports latest WPC 1.3 specification
- Supports bi-directional data communications
- 90% peak efficiency (system end-to-end)
- Switch mode PCLAMP/ECLAMP for robust overvoltage clamping
- Embedded 32-bit ARM™ Cortex®-M0 processor
- 32kB EEPROM memory to support OTA updates
- Easy to use GUI for customizing the design parameters
- 1.2V and multiple other IO voltage rail support to interface with processors of advanced technology nodes
- RA9530 Device Package: 6 × 8 ball array, 2.53 × 3.31 × 0.60 mm, 48-DSBGA with 0.40mm ball pitch

Evaluation Board

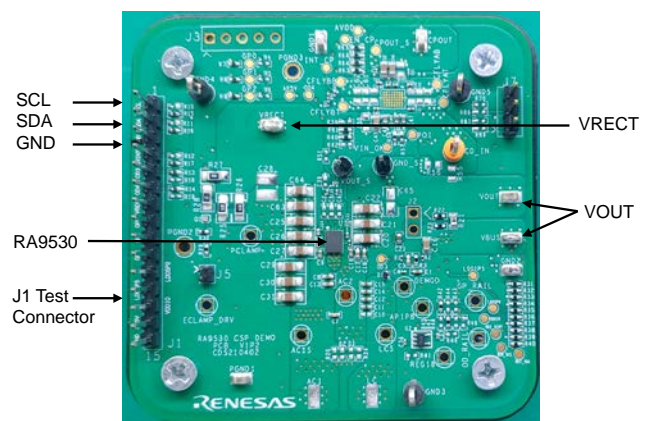

Contents

1. Board Setup	7
1.1 Required or Recommended User Equipment	7
1.2 Required Software on Computer	7
1.2.1. Software Installation	7
1.3 Usage Guide	8
1.4 Kit Hardware Connections for Rx Mode	8
1.4.1. Start Guide for Rx Operation	8
1.4.2. Rx Start Up	9
1.4.3. Modulation Waveform	9
1.4.4. Load Step	10
1.4.5. Load Dump	10
1.4.6. Rx System Efficiency	11
1.4.7. Rx Rectifier Voltage Level	12
1.4.8. Power Good operation – GP0	14
1.4.9. INHIBIT – OD4	15
1.5 Kit Hardware Connections for Wattshare (TRx) Mode	16
1.5.1. Start Guide for Wattshare TRx Mode Operation	16
1.5.2. Wattshare TRx Mode Input Voltage	18
1.5.3. TRx Mode Auto-Enable	18
1.5.4. TRx System Efficiency	19
2. RA9530-R-EVK Evaluation Board Test Point and Connector	19
2.1 RA9530-R-EVK Evaluation Board Test Point Placement	19
2.1.1. J3 Dongle Connector Pin Descriptions	19
2.1.2. J1 Test Connector Pin Descriptions	20
3. Hardware Connections Renesas USB-I2C Dongle to Windows GUI	20
3.1 Using the GUI to Program the RA9530	21
3.2 Using the GUI to Read / Write to Registers	25
3.3 Using the GUI to Read / Write Configuration Parameters to EEPROM	27
4. Rx Mode Functions	27
4.1 Synchronous Rectifier	27
4.2 Rectifier and VRECT Level	28
4.3 Over-Voltage Protection	28
4.4 Over-Current Protection, Over-Temperature Protection, and Thermal Shutdown	28
4.5 LDO Regulators	28
4.6 MLDO Output Enable Conditions	28
4.7 Renesas High-Power Mode	29
5. Wattshare Mode TRx Functions	30
5.1 Demodulator	30
5.2 WattShare Mode Input Under Voltage, Over Voltage, and Current Limit	30
5.3 Transmitter Conflict in WattShare Mode	30
6. TRx Wireless Power Coil	31
7. Resonance Capacitors	31

8. Input Capacitor (VRECT Capacitors)	31
9. Output Capacitor (VOUT Capacitors)	31
10. LDO1P5 Capacitor	31
11. LDO5P0 Capacitor	31
12. PCLAMP Connection	32
13. GPIO Pins	32
13.1 OD0/SCL Pin	33
13.2 OD1/SDA Pin.....	33
13.3 OD2/nINT Pin	33
13.4 OD4/INHIBIT(SLEEP).....	33
13.5 GP0/PWRGD Pin.....	33
13.6 GP2/TX_EN.....	33
13.7 Unused GP/OD Pin.....	33
14. Foreign Object Detection	33
14.1 FOD Parameters in Receiver Mode	34
14.2 FOD Parameters in Transmitter Mode	35
15. I²C Function	35
16. Board Design	36
16.1 Schematic Diagram	36
16.2 Bill of Materials	37
16.3 Board Layout	40
17. Device Registers	47
17.1 Common Registers.....	47
17.1.1. Chip Type (0x0000, 16-Bit)	47
17.1.2. Hardware Revision (0x0002, 8-Bit)	47
17.1.3. Customer Code (0x0003, 8-Bit)	47
17.1.4. Firmware Beta Revision (0x0017, 8-Bit)	47
17.1.5. Firmware Minor Revision (0x001C, 16-Bit)	48
17.1.6. Firmware Major Revision (0x001E, 16-Bit)	48
17.1.7. WPC Manufacturer ID (0x004A, 16-Bit).....	48
17.1.8. Firmware Date Code (0x00C4 - 0x00CF, 12 Bytes)	49
17.1.9. Firmware Time Code (0x00D4 - 0x00DB, 8 Bytes).....	50
17.1.10. System Operating Mode Register (0x004D, 8-Bit).....	50
17.2 RX Mode Registers.....	51
17.2.1. System Interrupt Clear Register in RX Mode (0x0028 - 0x002B, 32-Bit).....	51
17.2.2. System Status Register in RX Mode (0x002C - 0x002F, 32-Bit)	52
17.2.3. System Interrupt Register in RX Mode (0x0030 - 0x0033, 32-Bit).....	54
17.2.4. System Interrupt Enable Register in RX Mode (0x0034 - 0x0037, 32-Bit)	56
17.2.5. Battery Charge Status Register (0x003A, 8-Bit)	57
17.2.6. End of Power Transfer Register in RX Mode (0x003B, 8-Bit).....	58
17.2.7. Vout ADC Reading (0x003C, 16-Bit).....	58
17.2.8. Vout Set Register (0x003E, 16-Bit)	58
17.2.9. Vrect ADC Reading (0x0040, 16-Bit)	58

17.2.10. Iout Value Register (0x0044, 16-Bit).....	59
17.2.11. System Command Register (0x004E, 16-Bit).....	59
17.2.12. Proprietary Data-Out Registers (0x0050 - 0x0057, 8 Bytes).....	60
17.2.13. Proprietary Data-In Registers (0x0058 - 0x005F, 8 Bytes).....	60
17.2.14. ILIM Register (0x0060, 8-Bit).....	60
17.2.15. Over Voltage Register (0x0061, 8-Bit).....	61
17.2.16. Reference Resonance Frequency Register (0x0065, 8-Bit).....	61
17.2.17. RX Mode Communication Modulation FET Register (0x0067, 8-Bit).....	61
17.2.18. FOD Registers (0x0068 - 0x0077, 16 Bytes).....	62
17.2.19. Fast Charging Voltage Register (0x0078, 16-Bit).....	62
17.2.20. Vout Value Register (0x0080, 16-Bit).....	62
17.2.21. Vrect Value Register (0x0082, 16-Bit).....	63
17.2.22. Die Temperature Value Register (0x0084, 16-Bit).....	63
17.2.23. Operating Frequency Register (0x0086, 16-Bit).....	63
17.2.24. Digital Ping Frequency Register (0x0088, 16-Bit).....	63
17.2.25. CEP Value Register (0x00A5, 8-Bit).....	63
17.2.26. Tx Manufacturer Code Register (0x00B0, 16-Bit).....	63
17.2.27. TX Guaranteed Power Register (0x00B3, 8-Bit).....	64
17.2.28. TX WPC Revision ID Register (0x00B6, 8-Bit).....	64
17.2.29. Re-Negotiation Status Register (0x00B7, 8-Bit).....	64
17.2.30. Current Guaranteed Power (0x00B9, 8-Bit).....	64
17.2.31. Request Guaranteed Power (0x00BD, 8-Bit).....	64
17.2.32. Q-FACTOR Register (0x00D2, 8-Bit).....	64
17.2.33. Signal Strength Packet Register (0x00D3, 8-Bit).....	65
17.2.34. Hvod Sink Current Register (0x00F9, 8-Bit).....	65
17.2.35. Software Over Current Threshold Register (0x010C, 16-Bit).....	65
17.2.36. Software Over Current Threshold Hysteresis Register (0x010E, 8-Bit).....	65
17.2.37. Vrect Knee Register (0x0142, 8-Bit).....	65
17.2.38. Vrect Correction Factor Register (0x0143, 8-Bit).....	65
17.2.39. Vrect Maximum Correction Register (0x0144, 16-Bit).....	66
17.2.40. Vrect Minimum Correction Register (0x0146, 16-Bit).....	66
17.2.41. FOD Section Register (0x0149, 8-Bit).....	66
17.2.42. Vrect Adjust Register (0x014E, 8-Bit).....	66
18. TX Mode Register	67
18.1 System Interrupt Clear Register in TX Mode (0x0028 - 0x002B, 32-Bit).....	67
18.2 System Status Register in TX Mode (0x002C - 0x002F, 32-Bit).....	68
18.3 System Interrupt Register in TX Mode (0x0030 - 0x0033, 32-Bit).....	69
18.4 System Interrupt Enable Register in TX Mode (0x0034 - 0x0037, 32-Bit).....	70
18.5 Battery Charge Status Register (0x003A, 8-Bit).....	71
18.6 End of Power Transfer Register in TX Mode (0x003B, 8-Bit).....	71
18.7 Iin Value Register (0x0044, 16-Bit).....	71
18.8 Proprietary Data-Out Registers (0x0050 - 0x0057, 8 Bytes).....	71
18.9 Proprietary Data-In Registers (0x0058 - 0x005F, 8 Bytes).....	72
18.10 Tx EPT Type Register (0x007A, 16-Bit).....	72
18.11 TX System Command Register (0x007C, 16-Bit).....	73

18.12 TX Status Register (0x007E, 8-Bit)	74
18.13 Vin Value Register (0x0080, 16-Bit)	74
18.14 Vrect Value Register (0x0082, 16-Bit)	74
18.15 Die Temperature Value Register (0x0084, 16-Bit)	74
18.16 CEP Value Register (0x00A5, 8-Bit).....	74
18.17 Rx Manufacturer Code Register (0x00B0, 16- Bit)	74
18.18 Signal Strength Packet Register (0x00D3, 8-Bit)	75
18.19 Ping Interval Register (0x00E0, 16-Bit)	75
18.20 Ping Frequency Register (0x00E2, 16-Bit).....	75
18.21 Ping Duty Setting Register (0x00E4, 8-Bit)	75
18.22 Low Voltage Threshold Register (0x00EC, 16-Bit)	75
18.23 Over Voltage Threshold Register (0x00E8, 16-Bit)	75
18.24 FOD Low Segment Threshold Register (0x00F8, 16-Bit).....	76
18.25 FOD High Segment Threshold Register (0x00FA, 16-Bit)	76
18.26 FOD Segment Threshold Register (0x00FC, 16-Bit).....	76
18.27 Over Current Threshold Register (0x0108, 16-Bit).....	76
18.28 Minimum Operating Frequency in FB Register (0x0114, 16-Bit).....	76
18.29 Minimum Operating Frequency in HB Register (0x0116, 16-Bit)	77
18.30 Maximum Operating Frequency Register (0x0118 16-Bit).....	77
18.31 Minimum Duty Register (0x011A, 8-Bit)	77
18.32 TX DC Power Register (0x0156, 16-Bit).....	77
18.33 Operating Frequency Register (0x0182, 16-Bit).....	77
18.34 Operating Duty-Cycle Register (0x018C, 8-Bit).....	78
18.35 BLE MAC Address Registers (0x01B4 - 0x01B9, 6 Bytes)	78
19. Ordering Information	78
20. Revision History	78

Figures

Figure 1. Windows Device Manager Display for the USB Connection.....	7
Figure 2. Evaluation Kit Connections for Rx Mode Test.....	8
Figure 3. Rx Start Up	9
Figure 4. ASK Modulation Signal on CM1 and CM2	9
Figure 5. Load Step	10
Figure 6. Load Dump.....	10
Figure 7. Efficiency on P9235A-RB Tx (BPP, Vout = 5V)	11
Figure 8. Efficiency on P9243-GB Tx (EPP, Vout = 10V).....	11
Figure 9. Efficiency on P9243-GB Tx (High Power, Vout = 20V)	12
Figure 10. Rx VRECT Target Voltage on P9243-GB Tx (EPP Mode).....	13
Figure 11. Rx Vrect Target Voltage on P9235A-RB Tx (BPP Mode)	13
Figure 12. GP0 Output High when EPP Negotiation is Complete by Default (EPP Mode).....	14
Figure 13. GP0 Output High when VOUT Turns on (BPP Mode)	14
Figure 14. No ASK Packet when INHIBIT High at Start Up	15
Figure 15. Send EPT Packet when INHIBIT High at Power Transfer Phase	15
Figure 16. Evaluation Kit Connections for TRx Mode Test	16

Figure 17. TRx Mode Digital Ping Waveform	17
Figure 18. TRx Mode Charging Waveform.....	17
Figure 19. TRx Mode Charging Waveform.....	18
Figure 20. TRx System Efficiency.....	19
Figure 21. USB to I2C Dongle Header of “USB-FTDI-V2-1”(FTDI) Dongle.	21
Figure 22. USB to I2C Dongle Header of “WPD-USB- DONGLE”.	21
Figure 23. USB-I2C Bridge Connected to I2C Terminal J1 of RA9530-R EVK Board.....	21
Figure 24. Initial Screen of RA9530-R GUI	22
Figure 25. USB-bridge is Detected; RA9530 is Not Connected	22
Figure 26. RA9530 EEPROM Programming Using I2C Slave Device Address 0x3B.....	23
Figure 27. EEPROM Programming Successful.....	23
Figure 28. FW Program Verification Success.....	24
Figure 29. Verify FW Revision and Date Code.....	24
Figure 30. Read / Write to Registers	25
Figure 31. Basic Tab, after Clicking “Read 1 time”.....	26
Figure 32. Scripts Tab, after Clicking “Run”	26
Figure 33. Config Tab, after click “Read chip”	27
Figure 34. HPP Start-Up Waveform	29
Figure 35. WattShare Mode Demodulation Filter	30
Figure 36. PCLAMP Operation at OVP Condition in BPP Mode.....	32
Figure 37. Top and Top Silkscreen Layer	40
Figure 38. Inner1 Layer (GND Layer).....	41
Figure 39. Inner2 Layer (POWER/Signal/GND Layer)	42
Figure 40. Inner3 Layer (POWER/Signal/GND Layer)	43
Figure 41. Inner4 Layer (POWER/Signal/GND Layer)	44
Figure 42. Bottom Layer	45
Figure 43. Assembly Drawing.....	46

Tables

Table 1. Coil Manufacturer	31
Table 2. Recommended Maximum Estimated Power Loss.....	34

1. Board Setup

1.1 Required or Recommended User Equipment

The following additional equipment is required for using the kit:

- P9247-GB-EVK (REA High power mode enabled Tx) or P9243-GB-EVK (EPP transmitter with fast charge modes) or any WPC-certified transmitter for Rx mode test
- DC power source or adapter that power transmitter
- P9222-R EVK or any WPC-certified receiver for Wattshare (TRx) mode test
- Electronic load that can be connected to the RA9530-R-EVK
- WPD-USB-DONGLE for connecting with RA9530-R Windows GUI on computer and doing I2C transactions. WPD-USB- DONGLE is not shipped along with evaluation board and needs to be ordered separately

1.2 Required Software on Computer

Visit the RA9530-R-EVK web page and download latest version of the RA9530 Windows GUI and USB drivers. The Window GUI software provides an intuitive GUI for reading and writing to RA9530 registers, and programming custom user configurations to internal MTP memory.

1.2.1. Software Installation

Complete the following procedures to install the software:

1. Do not connect the WPD-USB-DONGLE dongle before installing the software.
2. Run the RA9530-R Windows GUI exe file. If you encounter a USB driver issue, please complete the following steps.
 - a. Run the downloaded *USB Drivers Setup* executable file and follow the user prompts to install the USB drivers.
 - b. After finishing the setup of the USB drivers, connect one of the WPD-USB-DONGLE dongles to the USB port. Wait for a few moments to let Windows® map the drivers for the dongle.
 - c. Open the Device Manager from the Windows control panel and check the devices listed under “Universal Serial Bus controllers” section. “FT4222H Interface A” and “FT4222H Interface B” should appear in this section as shown in the following figure.

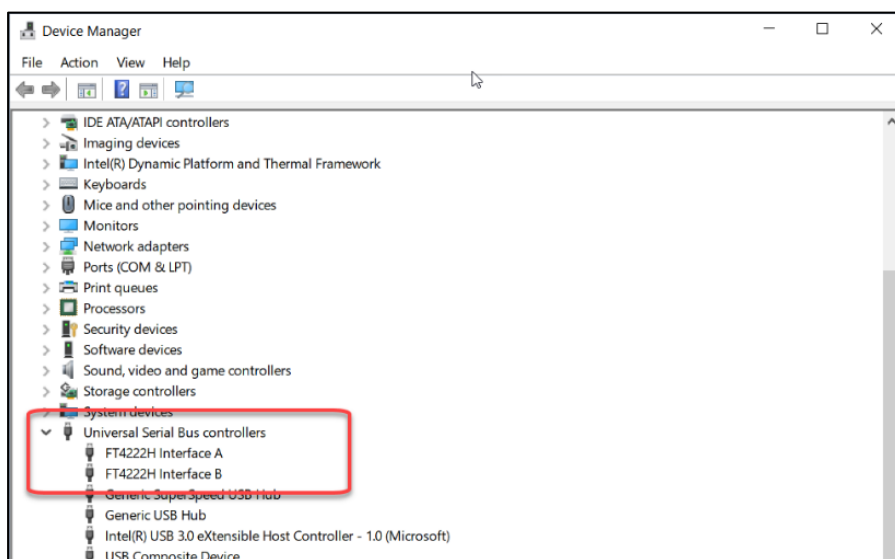

Figure 1. Windows Device Manager Display for the USB Connection

1.3 Usage Guide

The RA9530-R-EVK board can demonstrate the performance and functionality of the RA9530 wireless power receiver with TRX mode in a lab bench test environment.

1.4 Kit Hardware Connections for Rx Mode

Complete the following procedures to set up the kit as shown in Figure 2:

1. Set up the P9247-GB-EVK (REA high-power mode enabled Tx) or P9243-GB-EVK (EPP transmitter with fast charge modes) or other WPC certified transmitter according to the board's user manual and apply power.
2. Place the RA9530-R-EVK board on the transmitter coil surface with the coil back facing upwards.
3. Verify that the red LED on the P9247-GB EVK board is illuminated, which indicates that power transfer has been established.

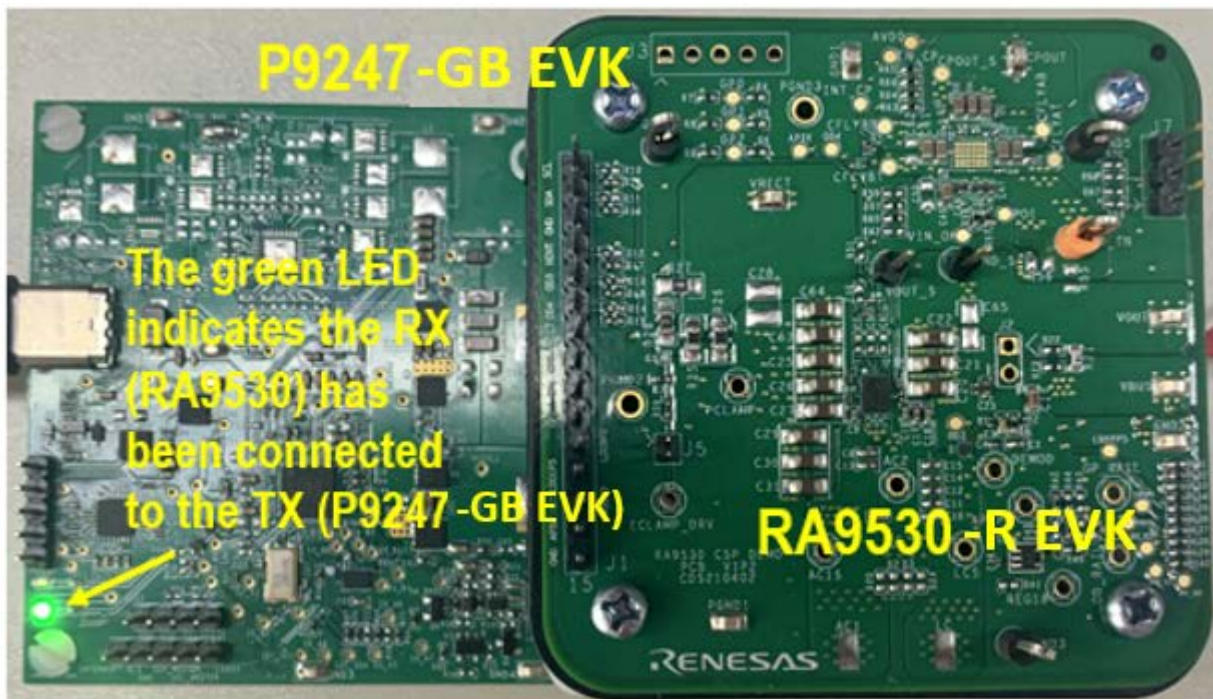

Figure 2. Evaluation Kit Connections for Rx Mode Test

1.4.1. Start Guide for Rx Operation

Place the bottom side of RA9530-R EVK onto an P9247-GB-EVK (REA High power mode enabled Tx) or P9243-GB-EVK (EPP transmitter with fast charge modes) or other WPC certified Tx unit. The RA9530-R-EVK includes a 55 x 55 x 0.4 mm TRx coil assembly. The charging pad can be a pre-powered and can be powered after placing the Rx coil on Tx charging pad.

Measure Rx output voltage at the VOUT test point to ground (GND). For convenience and measurement accuracy, two test points have been placed which allow for kelvin voltage sensing of the output voltage to omit conduction losses during evaluation (VOUT and GND). These should be used when performing efficiency measurements. The I2C dongle connector J3 can be used to interface with WPD-USB-DONGLE for programming the user configurable design parameters and it can be used to monitor the system status, mode, operating frequency, voltage, and current.

1.4.2. Rx Start Up

These procedures demonstrate Rx start-up operation:

1. Set up the Tx as described in section 1.4 and provide 18V DC to P9243-GB Vin.
2. Place Rx on Tx interface surface.
3. Trigger oscilloscope sweep on VRECT, VOUT and AC1 test point when Rx starts up.

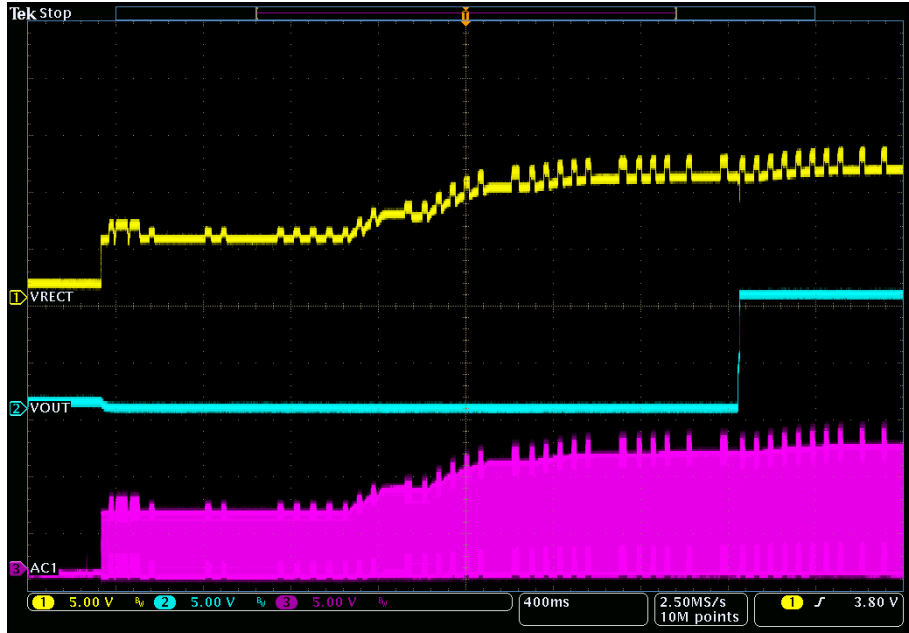

Figure 3. Rx Start Up

1.4.3. Modulation Waveform

RA9530-R modulates Rx AC signal with communication capacitor to send ASK packet to Tx.

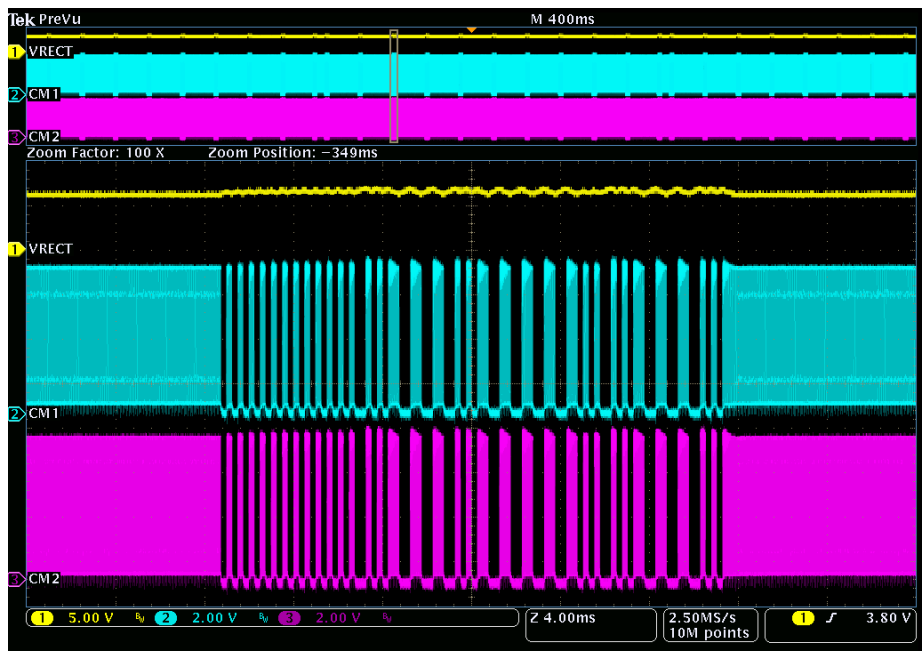

Figure 4. ASK Modulation Signal on CM1 and CM2

1.4.4. Load Step

The procedure for load step is as follows

1. Set up the Tx as described in section 1.4.
2. Provide a Rx Vout load from no load (high impedance) to 7ohm
3. Monitor load current, VRECT and VOUT voltage as shown in the following figure.

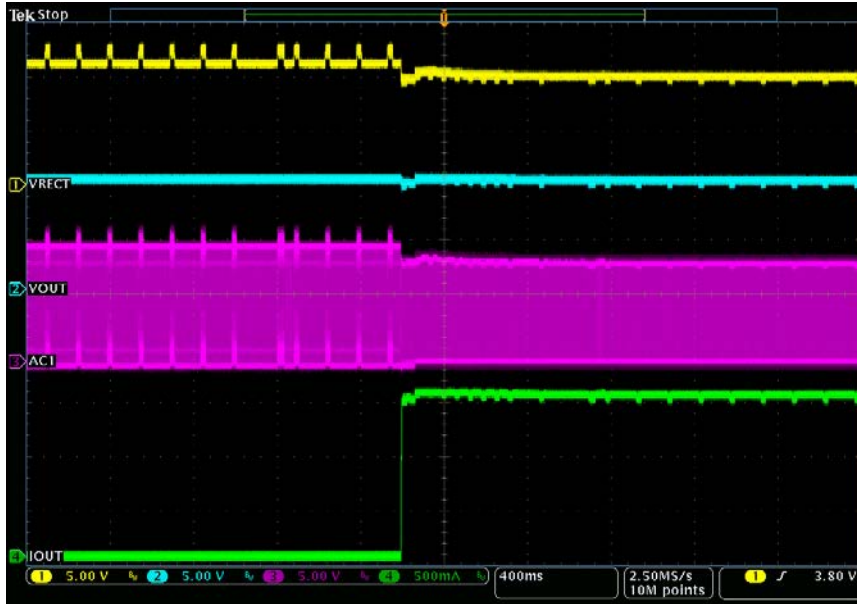

Figure 5. Load Step

1.4.5. Load Dump

The procedure for load dump is as follows

1. Set up the Tx as described in section 1.4.
2. Provide a Rx Vout load from 7ohm to no load (high impedance).
3. Monitor load current, VRECT and VOUT voltage as shown in the following figure.

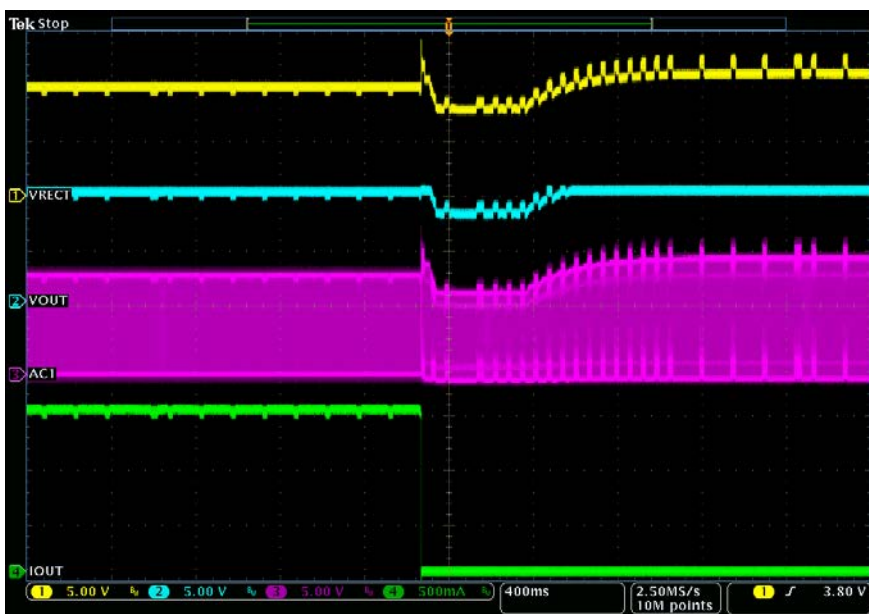

Figure 6. Load Dump

1.4.6. Rx System Efficiency

Figure 7 and Figure 8 show the Rx system efficiency using Tx P9235A-RB (BPP) and P9243-GB (EPP, HPP). Rx power is measured across RA9530-R VOUT and GND. Tx power is measured across Tx VIN and GND.

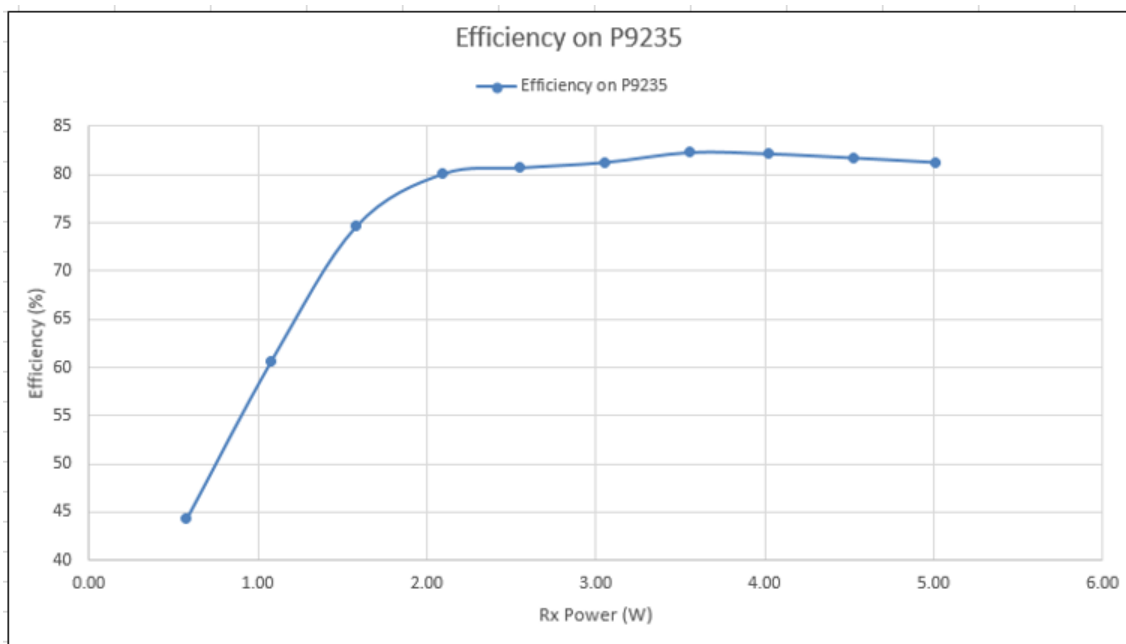

Figure 7. Efficiency on P9235A-RB Tx (BPP, Vout = 5V)

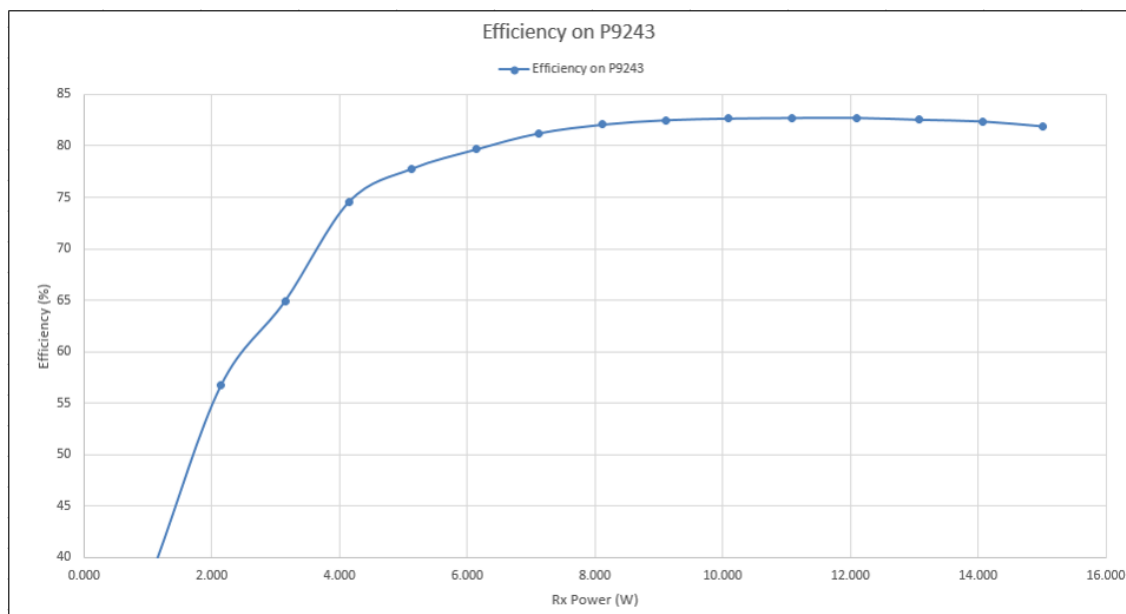

Figure 8. Efficiency on P9243-GB Tx (EPP, Vout = 10V)

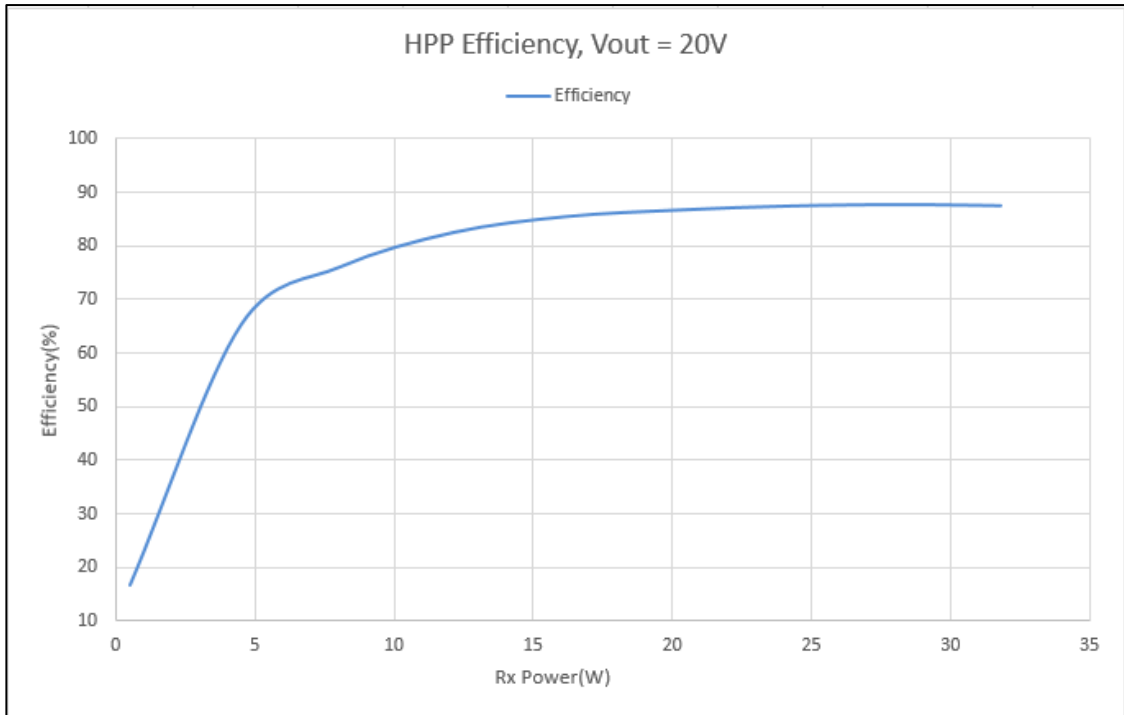

Figure 9. Efficiency on P9243-GB Tx (High Power, Vout = 20V)

1.4.7. Rx Rectifier Voltage Level

Rx Vrect target voltage level is changed by Rx lout current for system stability and optimal efficiency performance. The test procedure is as follows:

1. Set up the Tx as described in section 1.4.
2. Provide 18V DC to P9242-GB Vin (EPP Tx) and 5V DC to P9235A-RG Vin (BPP Tx).
3. Change Rx lout load current from low to maximum gradually and monitor Rx Vrect voltage level.

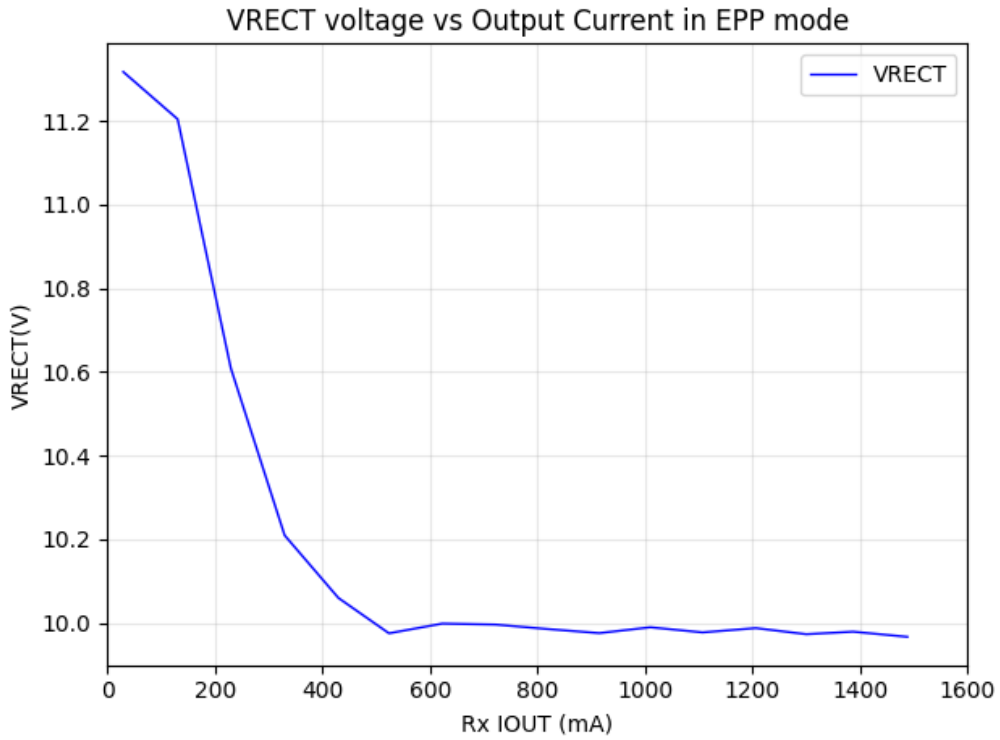

Figure 10. Rx VRECT Target Voltage on P9243-GB Tx (EPP Mode)

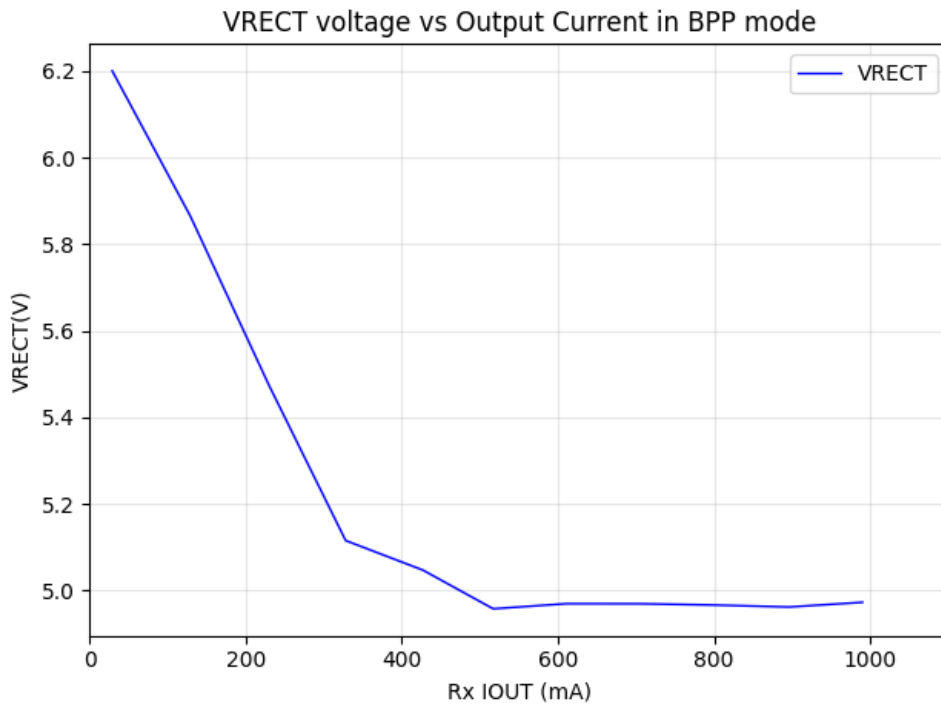

Figure 11. Rx Vrect Target Voltage on P9235A-RB Tx (BPP Mode)

1.4.8. Power Good operation – GP0

GP0 functions as power good indication. Figure 10 and Figure 11 show EPP and BPP mode power good waveform.

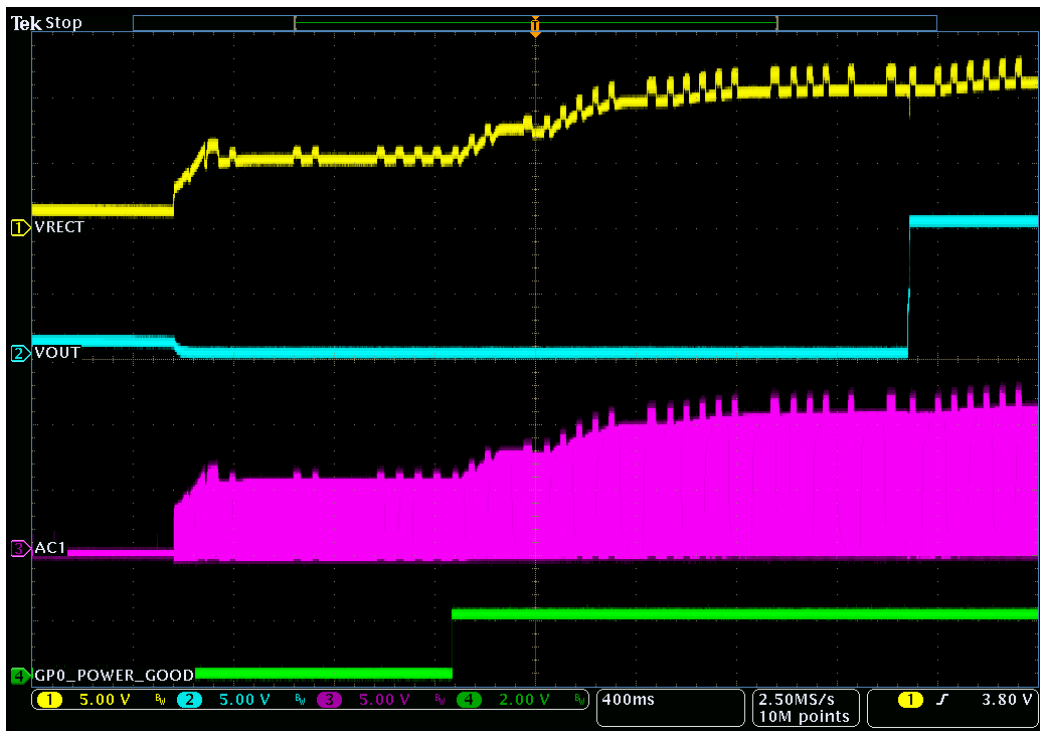

Figure 12. GP0 Output High when EPP Negotiation is Complete by Default (EPP Mode)

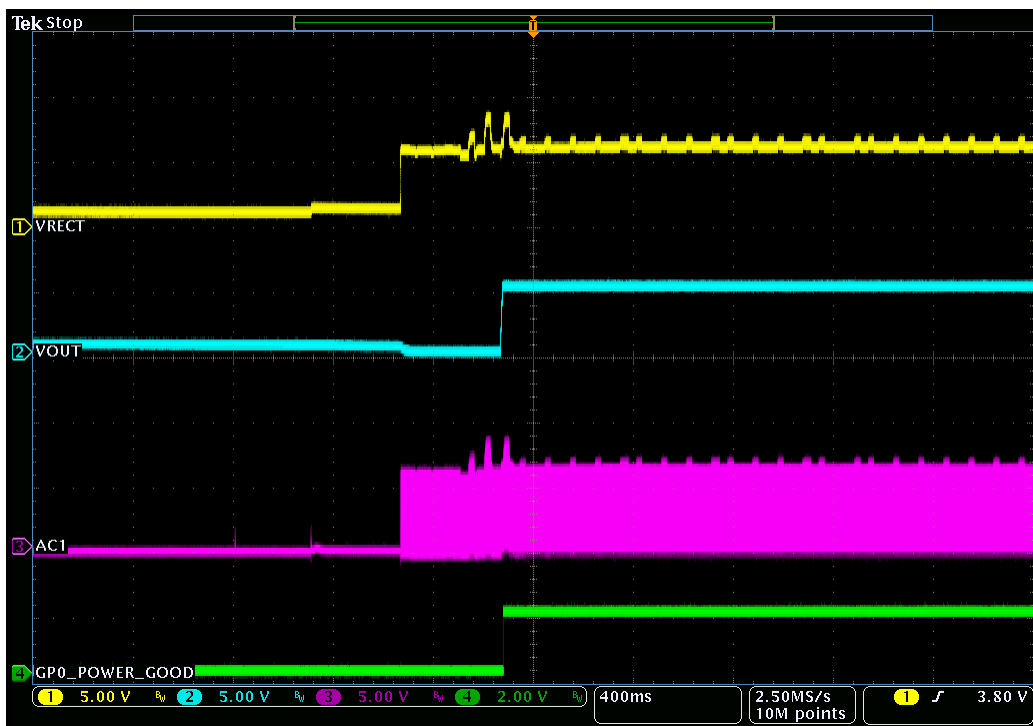

Figure 13. GP0 Output High when VOUT Turns on (BPP Mode)

1.4.9. INHIBIT – OD4

OD4 functions as INHIBIT(Sleep) operation. If OD4 is high, Rx does not send ASK packet at start up and sends End Power Transfer packet at power transfer phase.

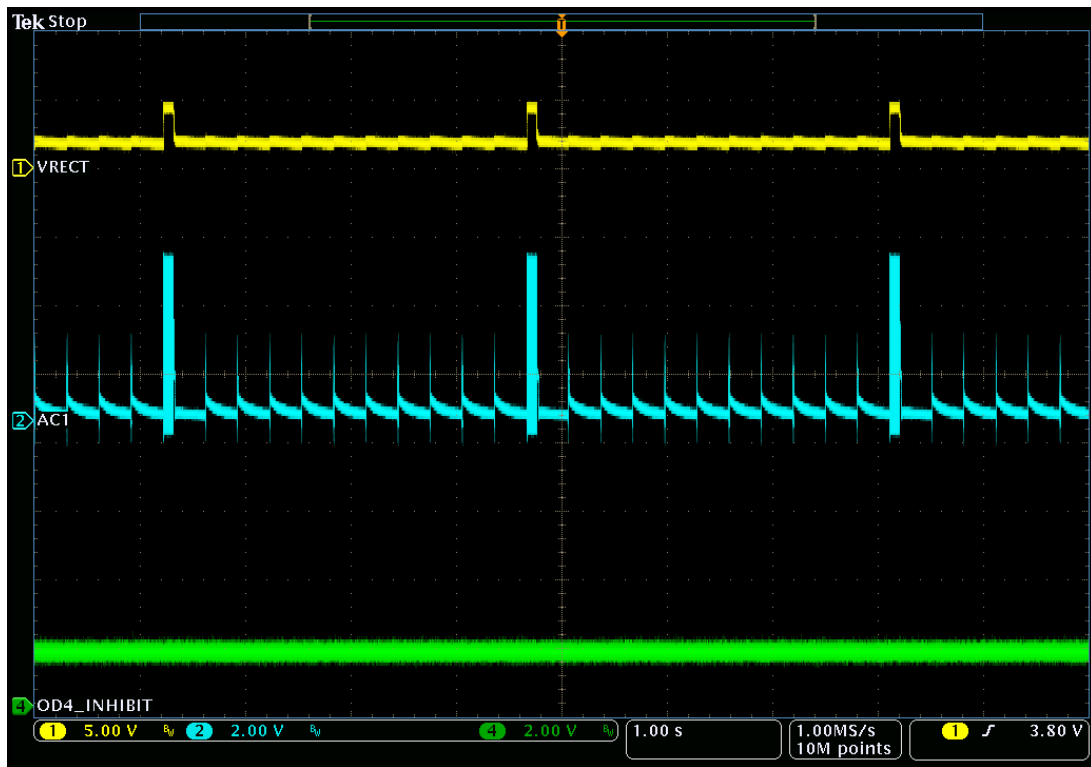

Figure 14. No ASK Packet when INHIBIT High at Start Up

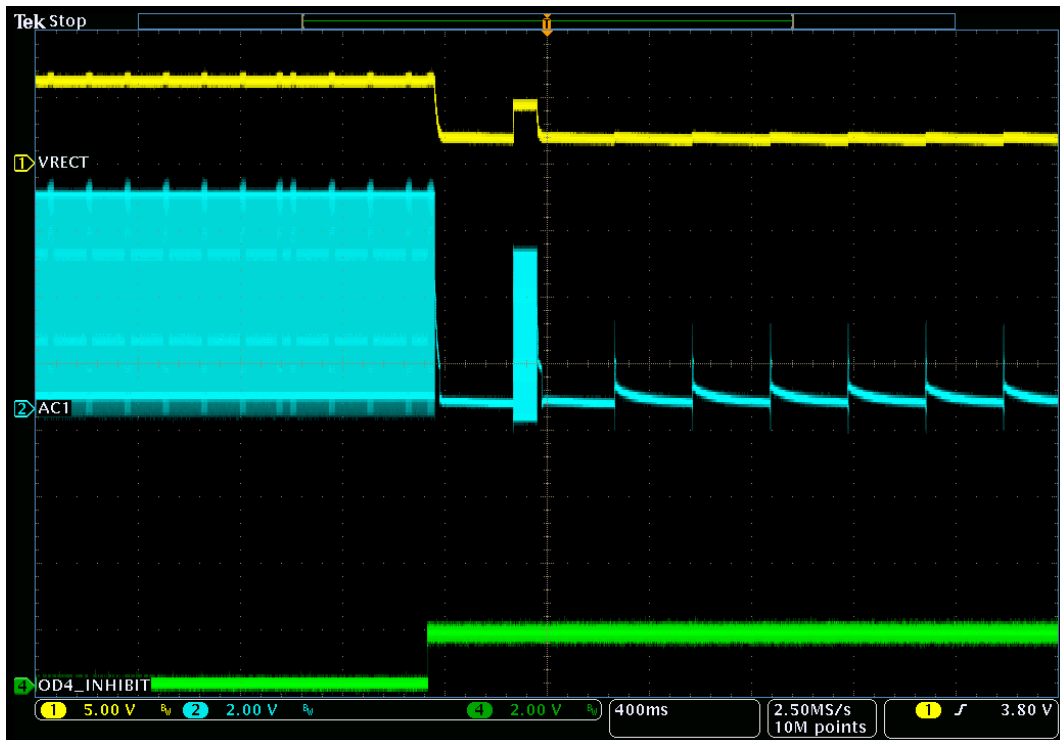

Figure 15. Send EPT Packet when INHIBIT High at Power Transfer Phase

1.5 Kit Hardware Connections for Wattshare (TRx) Mode

To set up the kit as shown in Figure 16, complete the following procedure:

1. Supply power on RA9530-R-EVK VOUT with DC power supply (7.5V).
2. Connect a WPD-USB-DONGLE on the RA9530-R-EVK J3 connector. USB dongle black line (GND) should be on J3 Pin3.
3. Send TRx mode command with RA9530-R Windows GUI (write 0x01 on 0x007C register).
4. Place the P9222-R-EVK Board or WPC-certified receiver on the reverse side of the RA9530-R-EVK. RA9530-R-EVK PCB boards acts as a spacer between Tx surface and Rx coil.
5. Verify that the green LEDs on P9222-R is illuminated, which indicates that power transfer has been established.



Figure 16. Evaluation Kit Connections for TRx Mode Test

1.5.1. Start Guide for Wattshare TRx Mode Operation

The RA9530 can be configured as a wireless power transmitter. The device uses an on-chip full/half-bridge inverter, a PWM generator, a modulator/demodulator for communication, and a microcontroller to produce an AC power signal to drive external L-C tank to operate as a wireless power transmitter (TRx). The RA9530 uses the same L-C tank in both Rx mode and TRx mode. In TRx mode, the power needs to be applied on the VOUT pin first which is the same node as the power receiver output when the device operates in Rx Mode. To avoid Tx conflict, ensure that the RA9530-R-EVK is not on the Tx pad.

1. Supply power (5V to 9V) on RA9530-R-EVK VOUT.
2. Write 0x0001 data to 0x007C register to enable TRx mode with RA9530-R Windows GUI or another I2C tool.
3. RA9530 starts sending digital pings after enabling TRx mode. Probe AC1 and check digital ping waveform.

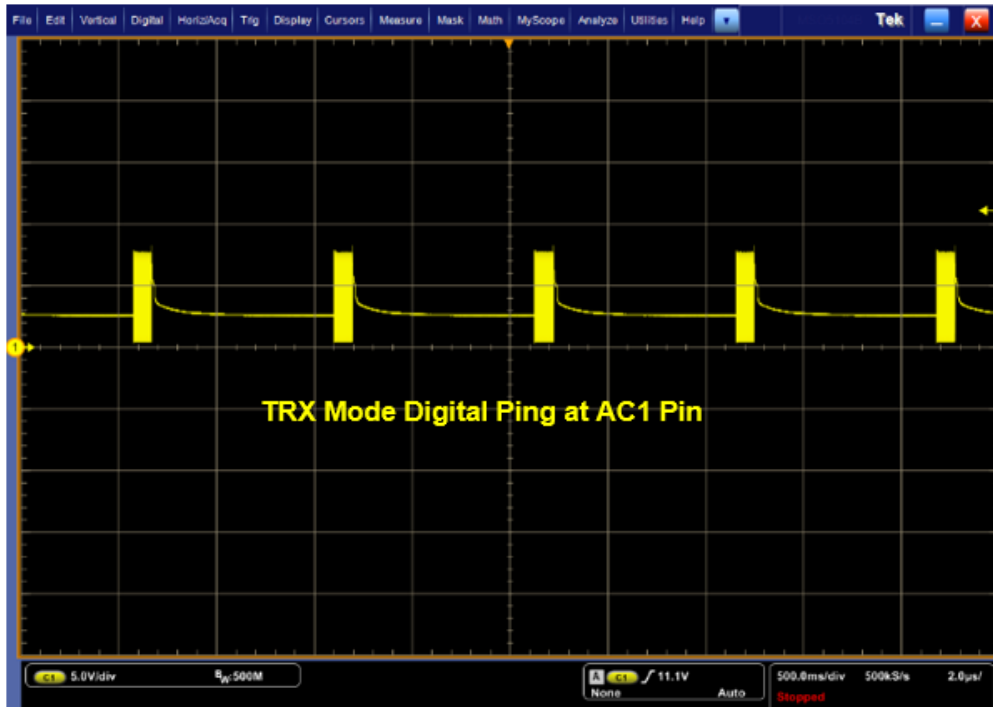

Figure 17. TRx Mode Digital Ping Waveform

4. Place the WPC compliant receiver on the RA9530-R-EVK TRx coil. The RA9530 will detect the Rx device and start power transfer right after WPC ID and Configuration packet.
5. Probe Rx VRECT and Rx VOUT, and confirm that charging is functional.

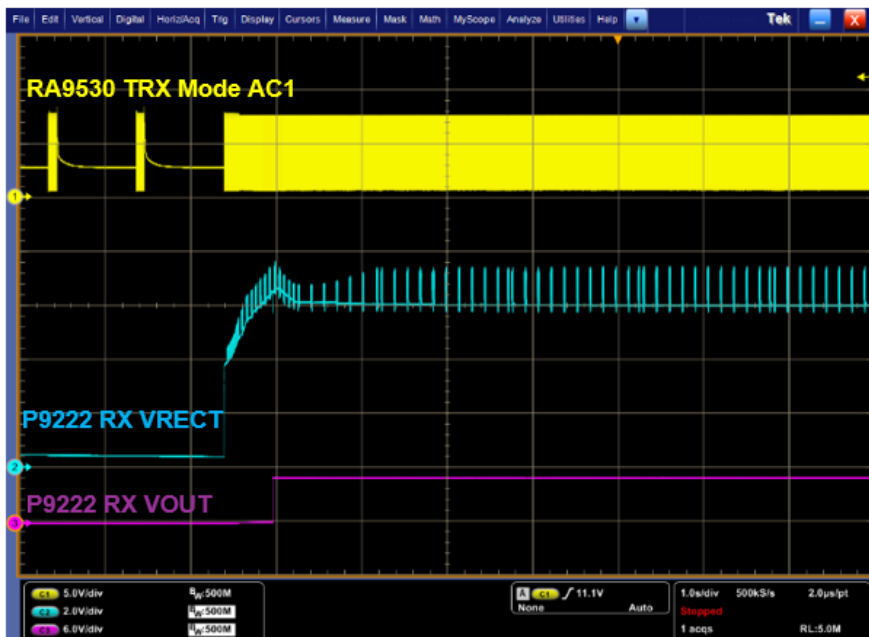

Figure 18. TRx Mode Charging Waveform

- TRx default digital ping frequency is 171kHz and the normal operating frequency range is from 115kHz to 145kHz in the default configuration. They can be changed using the RA9530-R GUI.

1.5.2. Wattshare TRx Mode Input Voltage

The RA9530 can transfer up to 5W of power in TRx mode. It follows the WPC 1.2.4 BPP protocol to transfer the power to other Qi-certified receivers such as mobile devices and earbud charging cases. The maximum power delivered in TRx mode depends on the input voltage on the VOUT pin, coil characteristics (such as AC resistance), and the friendly metal around the coil. Because the coil used for power transfer in TRx mode has high AC resistance compared to transmitter coil used in a charging pad, the input voltage on the VOUT pin in TRx mode must be around 7 to 9V to deliver 5W of power to the receiver.

1.5.3. TRx Mode Auto-Enable

The RA9530-R enters into TRx mode automatically if GP2 level is high when Vout is powered by external power or AP. The RA9530-R starts sending digital ping on TRx AC lines.

- Pull up the GP2 test pin with external power 1.8V.
- Provide 5V DC on RA9530-R VOUT.
- Monitor AC line if digital ping signal comes out periodically.

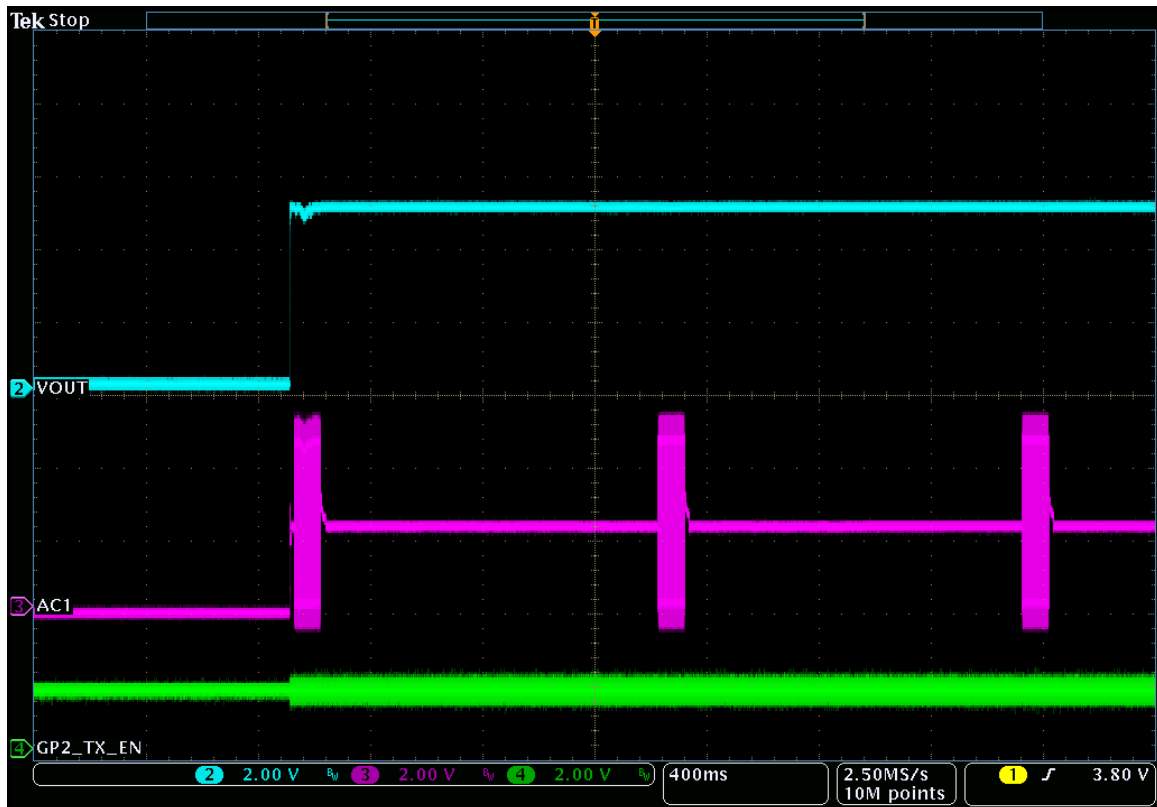

Figure 19. TRx Mode Charging Waveform

1.5.4. TRx System Efficiency

Figure 20 shows TRx system efficiency using P9415-R Rx at 7.5V and 9V TRx input voltage conditions. TRx power is measured across RA9530-R VOUT and GND. Rx power is measured across R9415-R VOUT and GND.

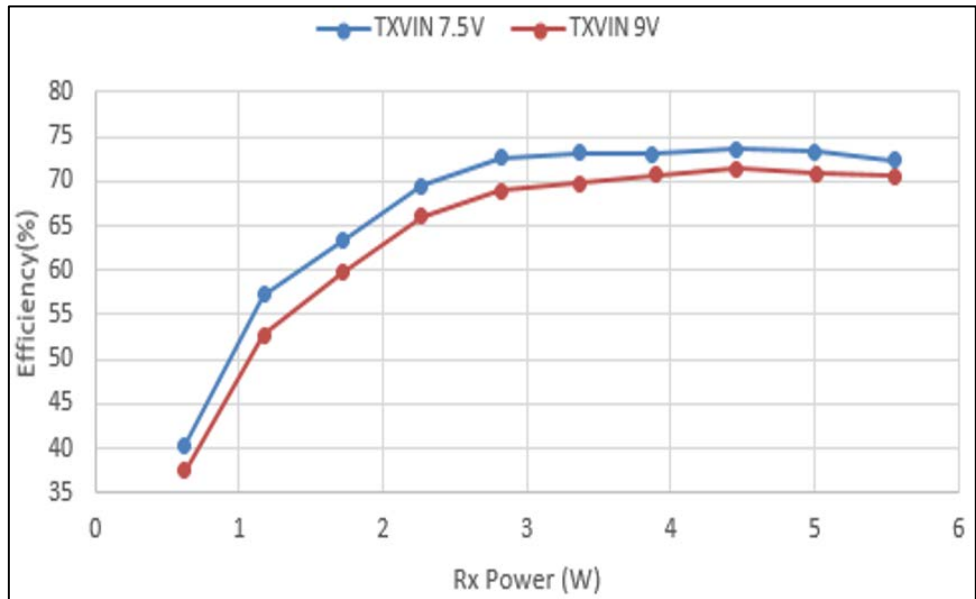

Figure 20. TRx System Efficiency

2. RA9530-R-EVK Evaluation Board Test Point and Connector

There are many test points placed around the RA9530-R_EVK board that can be used for quick and easy evaluation of RA9530 performance. VOUT, VRECT, and GND have large size test points for easy test cable connection for supplying power and loading. J3 and J1 are the pin type connector for USB-I2C bridge dongle interface connection and system configuration and monitoring.

2.1 RA9530-R-EVK Evaluation Board Test Point Placement

To locate the test points, see “Board Layout” section.

2.1.1. J3 Dongle Connector Pin Descriptions

Pin Number	Name	Type	Description
1	SCL	Input	I2C Interface Clock signal
2	SDA	Input /Output	I2C Interface Data signal
3	GND	Power	Ground Reference
4	VRECT	Power	Dongle Power supply from USB Dongle Cable (Optional)
5	OD2_NINT	Output	Interrupt Signal from RA9530. Connect OD2_NINT to AP GPIO with PU

2.1.2. J1 Test Connector Pin Descriptions

Pin Number	Name	Type	Description
1	SCL	Input	I2C Interface Clock signal
2	SDA	Input /Output	I2C Interface Data signal
3	GND	Power	Ground Reference
4	OD2_NINT	Output	Interrupt Signal from RA9530. Connect OD2_NINT to AP GPIO with PU
5	OD3	Input/Output	Reserved
6	OD4	Input/Output	INHIBIT(SLEEP)
7	VRECT	Power	VRECT power supply from USB dongle
8	GP0	Output	POWER GOOD Signal from LDO1p5 (Optional)
9	GP1	Input/Output	Available for GPIO Use. Connect to ground if not used
10	GP2	Input	TX EN
11	LDO5P0	Power	Internal Power Regulator 5.0V
12	LDO1P5	Power	Internal Power Regulator 1.5V
13	VDDIO	Input/Output	Internal capless LDO is connected and programmable as 1.2V/1.5V/1.8V. (Can be powered externally)
14	AP5V	Input	5V powered externally from AP (Optional)
15	GND	Power	Ground Reference

3. Hardware Connections Renesas USB-I2C Dongle to Windows GUI

The RA9530 firmware provides great flexibility to customize operating parameters for custom applications. Default values of the RA9530 operating parameters such as output voltage, FOD parameters, and current limit, are set in the firmware programmed into the internal electrically erasable programmable (EEPROM) memory. Based on the end application, the RA9530 operating parameters can be configured by either writing to internal SRAM registers or program parameter permanently to internal EEPROM memory via the I2C interface.

WPD-USB-DONGLE and USB-FTDI-V2-1 are recommended USB-I2C dongles. Both have same internal circuitry bit with a different dongle headers. Connect the WPD-USB-DONGLE/ USB-FTDI-V2-1 (USB-Bridge dongle) to a PC via the USB connector. Attach the Bridge to the I2C terminal J1 dongle on the RA9530-R-EVK board as shown on Figure 23. The dongle should only be plugged-in in one direction extending away from the RA9530-R-EVK PCB, and dongle cable black line (ground) should be connected to J1 Pin3 GND.

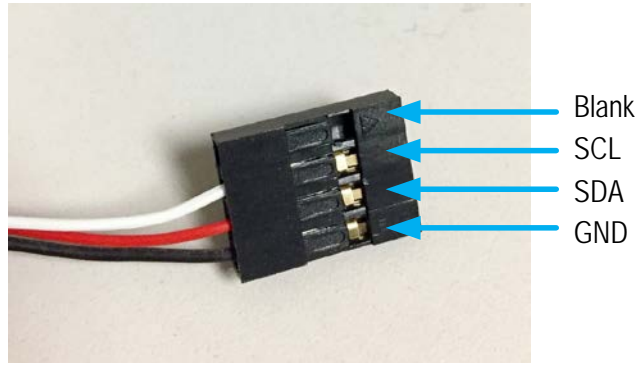

Figure 21. USB to I2C Dongle Header of “USB-FTDI-V2-1”(FTDI) Dongle.



Figure 22. USB to I2C Dongle Header of “WPD-USB- DONGLE”.



Figure 23. USB-I2C Bridge Connected to I2C Terminal J1 of RA9530-R EVK Board

3.1 Using the GUI to Program the RA9530

To program the device, remove the RA9530-R-EVK demo board coil from the Tx, connect GND, SDA, and SCL to the WPD-USB-DONGLE or other USB-I2C bridge as shown on Figure 23 and power Vrect or Vout from an external 5V power supply.

1. Open the GUI program – RenesasStandardGUI3.exe or newer version. The initial screen of the RA9530-R Windows GUI is shown below.



Figure 24. Initial Screen of RA9530-R GUI

Note: Make sure the external 5V power supply is turned on and the USB-I2C Bridge is connected to the PC. Verify that the Device selected is the RA9530, and that the slave address is set to 0x3B at the top of screen. Check the “FTDI dongle detected” and “RA9530 connected on FTDI dongle” messages are shown at the bottom of the screen. If you do not see these messages, unplug the USB cable at the PC side, plug it in again and check all connections.

If the message indicates that the “FTDI dongle detected” but the RA9530 is not connected, it may be necessary to click on “FTDI” to redetect the device (see Figure 37).



Figure 25. USB-bridge is Detected; RA9530 is Not Connected

- To update the EEPROM program, select the “FW Pgm” tab. Select BIN or HEX box depending on the file format you intend to use and press the “Load file” button. A popup window will appear. Navigate to the current RA9530 FW file and open the file (see the following figure, which indicates the FW file was read successfully).

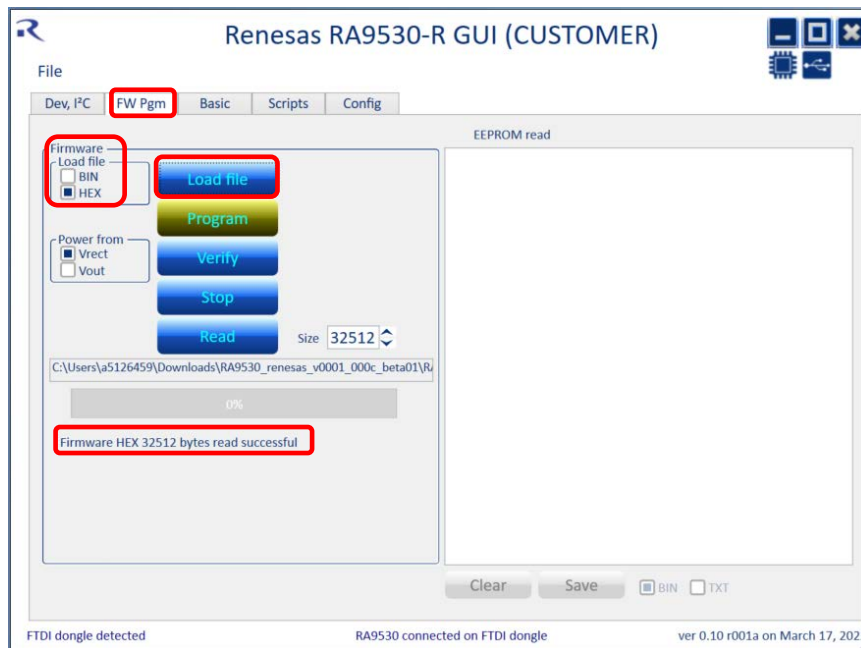

Figure 26. RA9530 EEPROM Programming Using I2C Slave Device Address 0x3B

- After loading the file, select Vrect or Vout depending on where your power supply is connected to and press the “Program” button. The EEPROM will be programmed and the GUI will indicate if successful or if there were errors. See Figure 10, which indicates that the programming was successful. If there are any errors, attempt to program again.

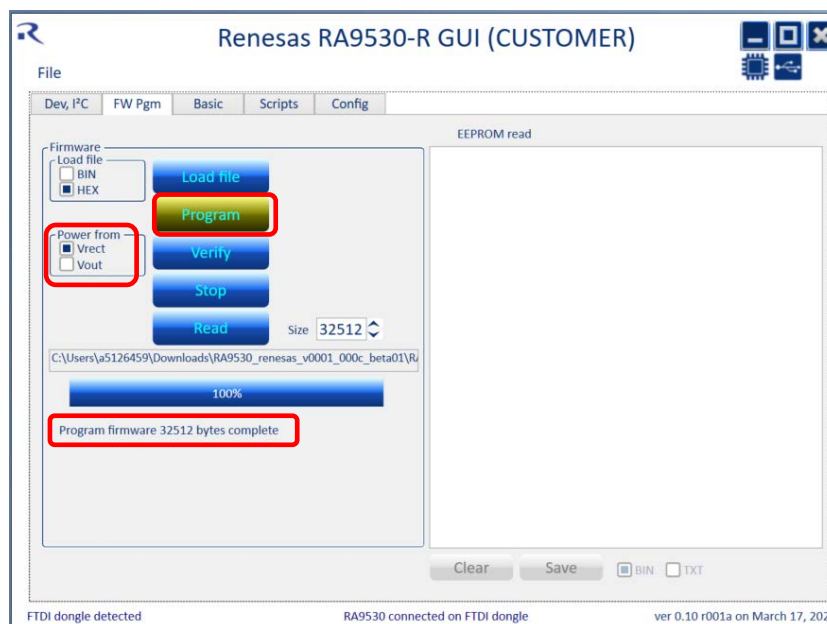

Figure 27. EEPROM Programming Successful

4. If the firmware was programmed successfully, power cycle the external 5V power supply (turn the power supply off, then on), then press the “Verify” button. A total match should be indicated for successful programming (see Figure 39. If there are any errors, attempt to program again).

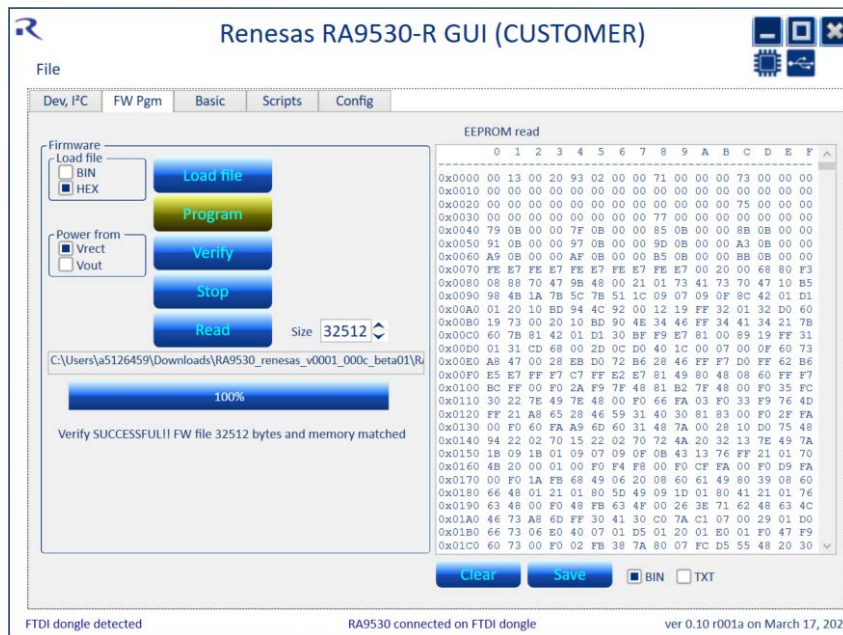

Figure 28. FW Program Verification Success

5. After programming and verification success:
 - a. Verify programming. It is recommended to select the “Basic 1” tab and press the “Read 1 time” button to check the FW revision, date code is correct.
 - b. Turn off and remove the external 5V power supply on Vrect and Vout and place the RA9530-R-EVK on a compatible Tx.

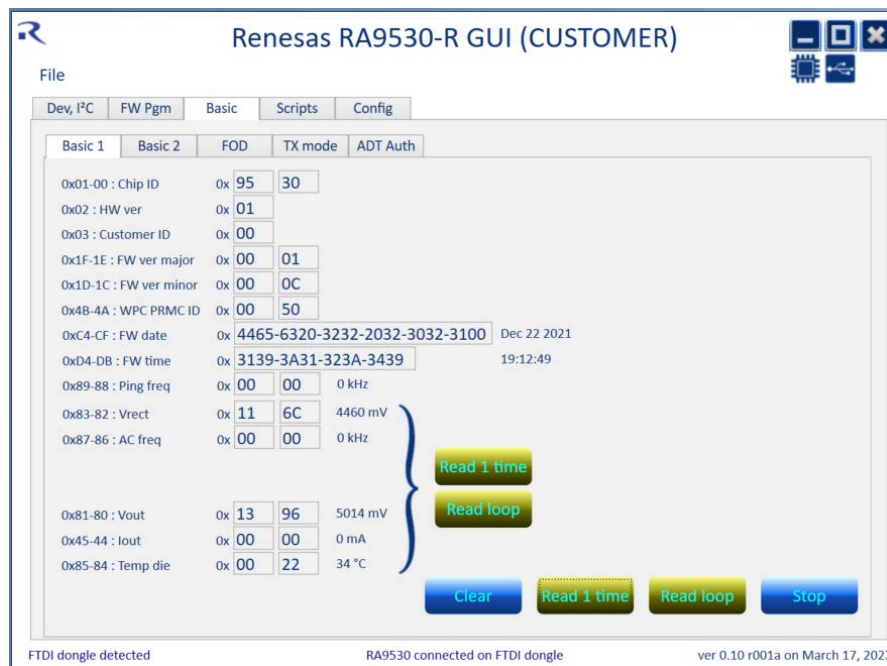

Figure 29. Verify FW Revision and Date Code

3.2 Using the GUI to Read / Write to Registers

Access to the RA9530 status and control settings are done by reading and writing the I2C registers. The registers are described in “Device Registers”. To read and write to the registers, complete one of the following procedures:

1. To read and write specific registers, select the “Dev, I2C” tab.
 - a. To read from a register, select “Rd” and click “Run” to read the hex register address that specified in the “Addr” box. Hex data will be displayed in “Data” box.
 - b. To write to a register, select “Wr” and click “Run” to write the hex data provided in “Data” to the hex register address in “Addr”.
 - c. To read/write all the registers in the boxes, click “Run 1 time”. The sequence of the read/write operation will be the same as how the registers are listed.
 - d. To read/write all the registers in the boxes repeatedly, click “Run loop”. “Loop wait” and “Loop count” can be set to configure the operation interval time and total counts. If “Loop count” is 0, the loop will go infinitely.
2. To read and write specific registers, click the “I2C reg Rd/Wr” box in “Dev, I2C” tab. The I2C Rd/Wr block will stay accessible.

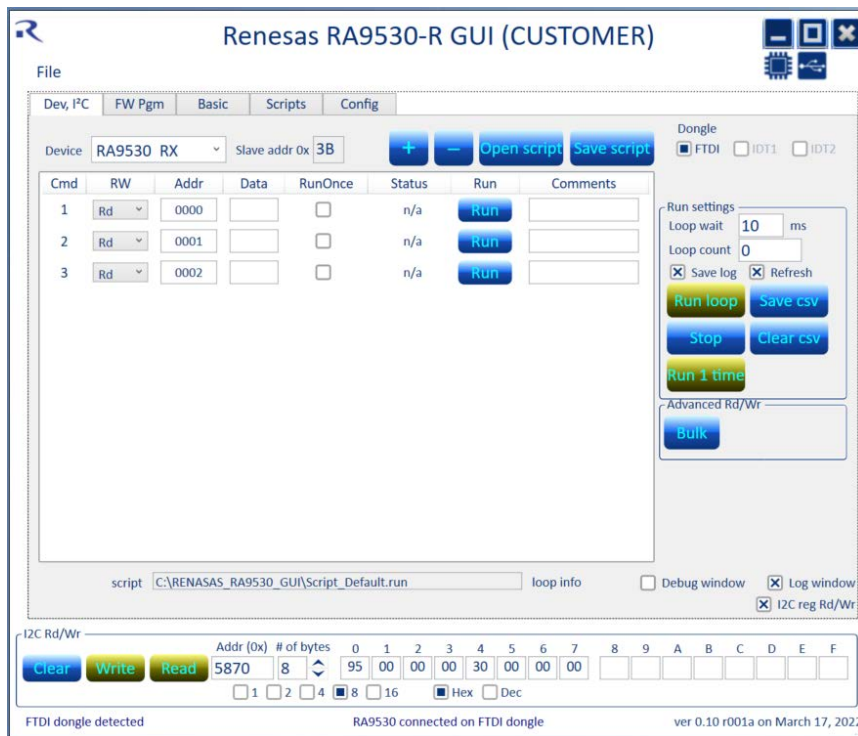

Figure 30. Read / Write to Registers

- For bulk reading of common operating registers, select the “Basic” tab and click the ‘Read 1 time’ or the “Run loop”. “Run loop” can be stopped by selecting ‘Stop’. Click “Write” to write data to the according register.

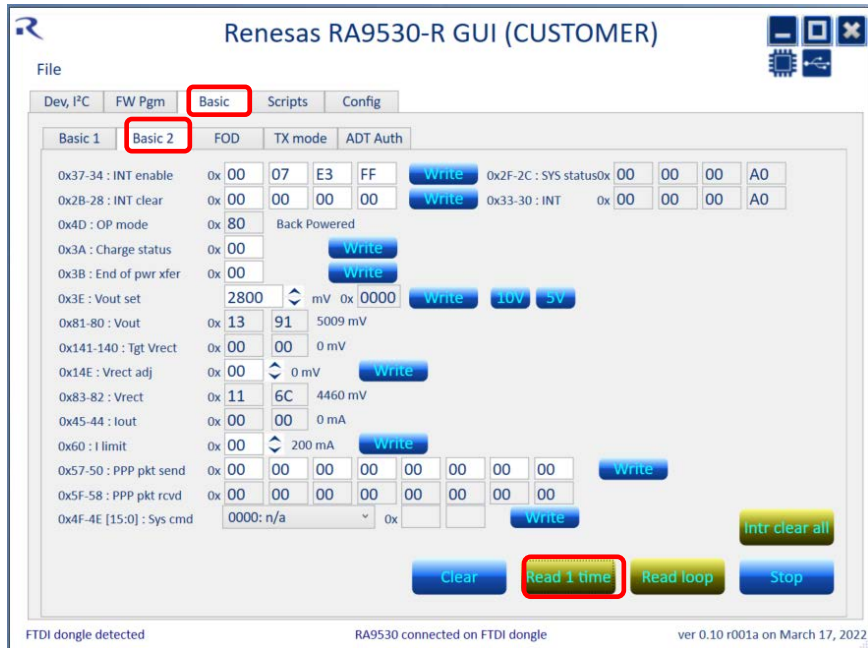

Figure 31. Basic Tab, after Clicking “Read 1 time”

- Read and write data to the RA9530 registers through scripting. To write 1byte data value 0x01 to register address 0x3200, select the “Scripts” tab and type in “.i2c_cmd_wr(3200, 1, 01)” as shown in Figure 42 and click “Cmd 01”. To read 2bytes data from register address 0x3200, type in “.i2c_cmd_rd(3200, 2)” and click “Cmd 02”. The reading result will be shown in the log window. To perform all operations listed in the “Script commands”, click “Run”. The sequence of the read/write operation will be the same as how the commands are listed.



Figure 32. Scripts Tab, after Clicking “Run”

3.3 Using the GUI to Read / Write Configuration Parameters to EEPROM

Configuration parameters in RX mode and TRx mode operation can be read from and written to EEPROM flash memory after modification. The configuration parameters written in EEPROM are non-volatile.

1. Select the “Config” tab and click “Read chip”. The configuration hex parameters will be read from EEPROM and displayed in the tables of both the TRx and RX setting. In the TRx setting page, proprietary FOD setting can be configured in a new window by clicking “Proprietary FOD”. If “Reset cfg” is clicked, the tables in both TRx setting and RX setting are updated with the default configuration parameters.
2. After modifying the hex parameters in tables, click “Write chip” and all the data displayed in the tables of both TRx setting and RX setting will be written to EEPROM. Power off and on chip after “Write chip”. New parameters will be applied from the next time wireless charging operation. You can also save the modified configuration parameters in your local drive by clicking “Save cfg file”. “Open cfg file” will read the cfg file in your local drive and display the configuration parameters in the tables.

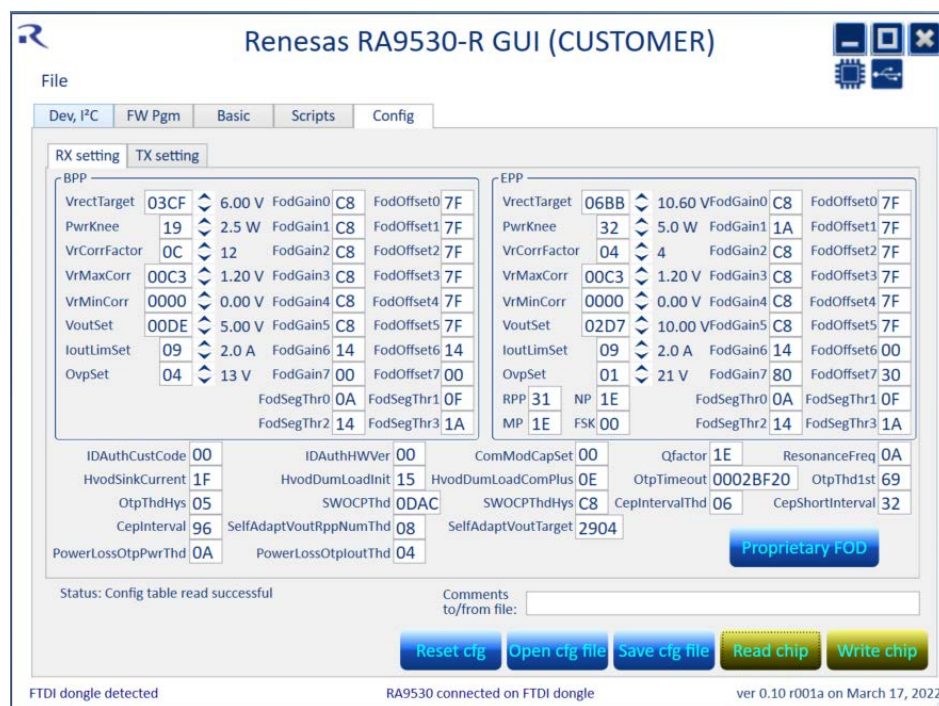

Figure 33. Config Tab, after click “Read chip”

4. Rx Mode Functions

4.1 Synchronous Rectifier

The efficiency of the full-bridge rectifier in the RA9530 is increased by implementing it as a synchronous rectifier. The rectifier comprises four internally-driven switches that work in a full synchronous mode of operation when the load applied to VOUT is higher than the programmed threshold value. Below that threshold, the rectifier works in half-synchronous rectification mode. In half-synchronous rectification mode, only the low-side N-MOSFETs are driven and the high-side N-MOSFETs are forced into diode mode. At power-up, when the voltage is below the UVLO threshold, the rectifier works by using the body diodes associated with the NMOS transistors. The BST capacitors are used to provide power to drive the gates of high-side NMOS switches.

4.2 Rectifier and VRECT Level

When VRECT powers up to be greater than UVLO, the full-bridge rectifier switches to half synchronous or full synchronous mode (depending on the loading conditions) to efficiently transfer energy from the transmitter to the load applied to VOUT. The control loop of the RA9530 maintains the rectifier voltage between 5V and 23.5V, depending on the output current (I_{OUT}) and the programmed output voltage. VRECT must not be directly loaded.

4.3 Over-Voltage Protection

When VRECT reaches 90% of the over-voltage threshold voltage, the OVP interrupt is triggered and the PCLMAP function is turned on. On an over-voltage condition, the RA9530 turns on the internal PCLAMP to bring the rectifier voltage back to a safe operating level and sends an interrupt to the AP to notify of the over-voltage condition. The over-voltage threshold value is different by Rx operation mode and there is hysteresis to make a stable operation. In BPP mode, the default OVP threshold voltage is 13V for rising and 12V for falling direction. In EPP mode default OVP voltage is 21V for rising and 19V for falling. In HPP mode, OVP voltage is 24.6V for rising and 22.9V for falling. These thresholds can be configured in EEPROM. When PCLAMP is turned on, excessive power is consumed by the external PCLAMP resistor. Select the appropriate resistor value based on the power rating.

PCLAMP current is OVP threshold voltage/ PCLAMP resistor. The PCLAMP maximum current should be less than 300mA.

4.4 Over-Current Protection, Over-Temperature Protection, and Thermal Shutdown

The RA9530 uses over-current (OC) protection and over-temperature (OT) protection by sending an interrupt to the AP if the output current or die temperature exceeds the operating limits.

If output current exceeds the over-current threshold value, an over-current fault interrupt is sent to the AP with the expectation that the AP will respond by reducing the output consumption being drawn from the RA9530. If the output current reaches the over-current threshold plus the over-current threshold hysteresis value, an over-current fault interrupt is sent to AP and an End Power Transfer packet (OCP) is sent to the transmitter.

If the die temperature exceeds the over-temperature threshold1 (default 105°C), the RA9530 first sends an interrupt (OTP) to the AP to alarm the over-temperature condition and starts the OTP timer (180sec default). If the temperature falls below over-temperature threshold1 – hysteresis (5°C), OTP timer resets. If the die temperature keeps increasing and exceeds the over-temperature threshold2 (default 135°C) or the OTP timer expires, the RA9530 sends an End Power Transfer Packet to the transmitter to terminate a power transfer. If the temperature keeps increasing and exceeds the thermal shutdown threshold (typical 140°C), the RA9530 turns off output LDO.

4.5 LDO Regulators

The RA9530 has 4 LDOs. The Main LDO (VOUT pin) is programmable from 5V to 20V and LDO5P0 is powered by VRECT. LDO1P5 and VDDIO are powered by LDO5P0. Both LDO5P0 and LDO1P5 are used for supplying power to internal low voltage blocks. The LDOs must have local ceramic bypass capacitors placed near the RA9530. VDDIO is internal capless LDO that can be used for general purpose IO power. VDDIO is programmable as 1.2V/1.5V/1.8V based on application IO power. 1.8V is default level.

4.6 MLDO Output Enable Conditions

In BPP mode, after entering the power transfer phase, the RA9530 starts sending control error packets with high value to raise the VRECT voltage close to its target value and starts a two-second timer. The RA9530 enables the MLDO when the VRECT voltage reaches the target voltage or the two-second timer expires.

In the EPP mode, the RA9530 enables the MLDO when it receives ACK from Tx in calibration phase1 and Vrect is within target voltage range. If the RA9530 does not reach target Vrect level in calibration phase 1 until it sends

mode1 RPP 8 times(default), the MLDO target voltage is reduced from 10V to 9V (default configurable) and move to calibration mode2 after enabling MLDO.

4.7 Renesas High-Power Mode

The application processor on the receiver can authenticate the Transmitter using the in-band communication. After successful authentication of the transmitter, the high-power mode can be enabled. Thereafter, the application processor should use the Fast Charging Voltage Register to control the desired output levels. The RA9530 will automatically change VOUT value if the Fast Charge Sequence is successful.

1. Place the Rx on Renesas HPP supporting Tx (P9247-GB EVK).
2. The Rx will authenticate Tx ID using proprietary packet during power transfer phase.
3. The Rx reports AP of authentication result using interrupt signal.
4. If interrupt register (0x30) bit 13 is set, authentication is a success.
5. The AP can set the fast charging voltage in register (0x78) if authentication is success.
6. The Rx will increase Vout voltage to the target level along with automatic Tx Vin voltage control.

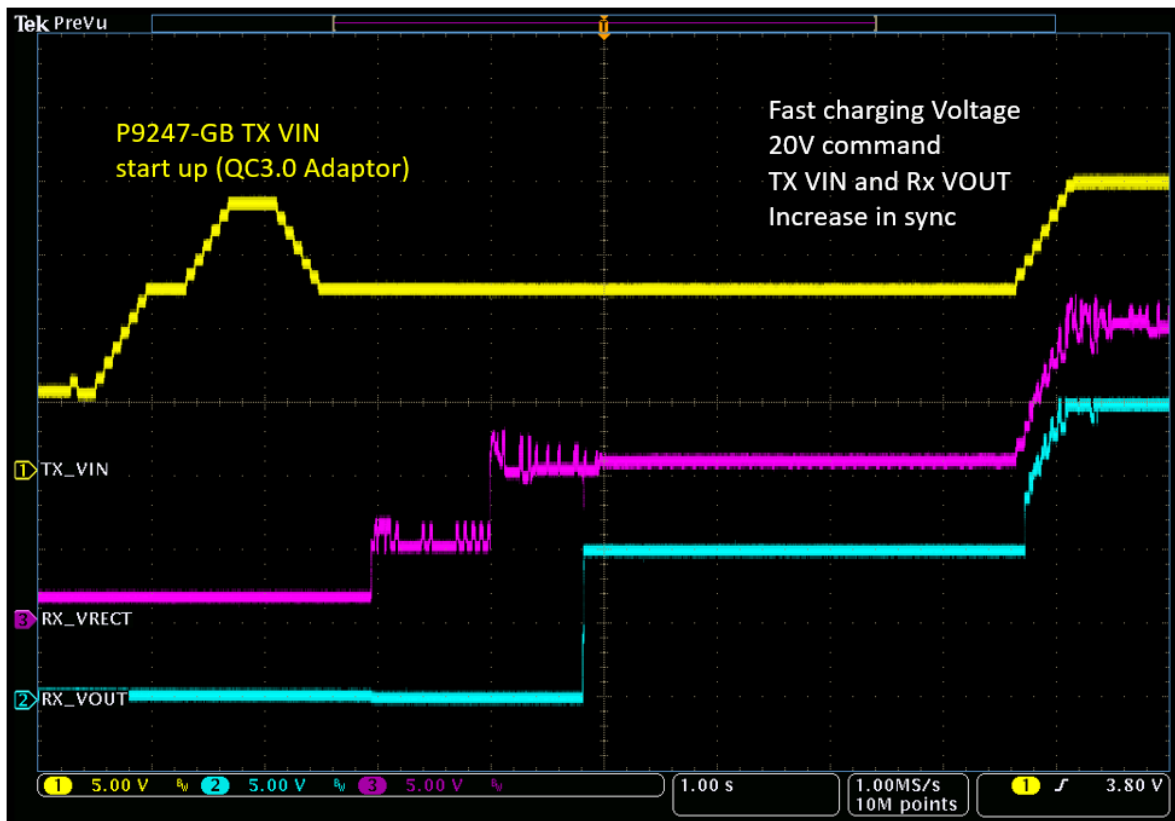

Figure 34. HPP Start-Up Waveform

5. Wattshare Mode TRx Functions

5.1 Demodulator

In TRx Mode, the Rx sends WPC protocol packets to the RA9530. Using the demodulation (DEMOMD) filter shown in Figure35 and the internal demodulator circuitry, the RA9530 decodes the ASK modulation packets Rx sent. Based on the packet information, the RA9530 modulates the transmitted power by adjusting the operating frequency or duty cycle and detects a foreign object between Tx and Rx.

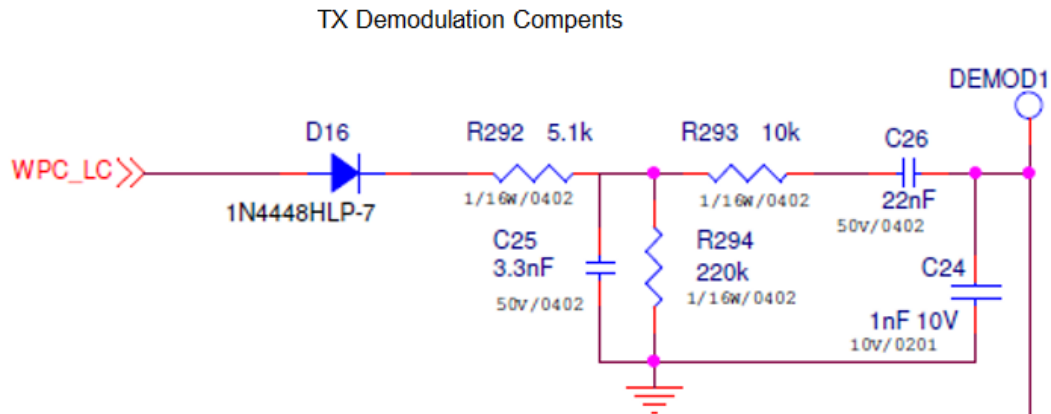

Figure 35. WattShare Mode Demodulation Filter

5.2 WattShare Mode Input Under Voltage, Over Voltage, and Current Limit

In the default firmware there are several over-current protection thresholds in the WattShare mode that are applied differently depending on the operation phase.

In the ping phase, if the input current exceeds the Ping OCP threshold (default 1.5A), the RA9530 sets flag EPT_POCP in TRx End Power Transfer Reason Register and sends an interrupt EPT_TYPE_INT to the AP and disables the TRx function. TRx will not resume until the AP recycles the power on the VOUT pin and enables the TRx mode again.

In the power transfer phase, if the input current exceeds the IgnoreCepThd (default 2.5A), the RA9530 enters in CEP Ignore mode. If the average input current exceeds the OCP threshold (default 2.5A), the RA9530 sets flag EPT_OCP in TRx End Power Transfer Reason Register and sends an interrupt EPT_TYPE_INT to the AP and disables the TRx function. TRx will not resume until the AP recycles the power on the VOUT pin and enables the TRx mode again.

If the voltage on the VRECT pin is higher than the over-voltage protection OVP threshold (default 11V), the RA9530 sends interrupt EPT_TYPE_INT to AP, sets the EPT_OVP bit of TRx End Power Transfer Reason Register, and disables the TRx function.

If the voltage on the VOUT pin is lower than the low voltage protection (LVP) threshold (Default 4.5V), the RA9530 sends interrupt (EPT_TYPE_INT) to AP.

5.3 Transmitter Conflict in WattShare Mode

When the RA9530 is in WattShare mode, the user may accidentally place the RA9530 on another WPC transmitter. The pings from the WPC transmitter will generate an AC voltage in the resonant tank connected to the RA9530. The RA9530 detects this voltage, sends an interrupt (TX_Conflict) to the AP, and exits TRx mode. The AP must disable the external power supply connected to the VOUT pin of the RA9530.

6. TRx Wireless Power Coil

The TRx coil is dependent on customer requirements and most are custom designs. Renesas recommends the following TRx coil and it was installed in RA9530-R demo board.

- $L_s = 8$ to $10\mu\text{H}$
- $\text{DCR} = < 0.3\Omega$
- $\text{ACR} = < 0.4\Omega$

Table 1. Coil Manufacturer

Output Power	Vendor	Part Number	Inductance at 100kHz	Resonant Caps (Cs)	DC Resistance at 20°C
15W	Luxshare	ICTR-QS5858031L-MW034	$9.0 \pm 0.2\mu\text{H}$	400nF	$195\text{m}\Omega \pm 10\%$

7. Resonance Capacitors

The series resonance capacitors (C10, C11, C12, C14, and C15) are critical components and must be chosen carefully. All current that flows to the load flows through these components plus any current loss in the rectifier AC to DC conversion. The recommended capacitor is the 100nF Murata (GRM155C71H104KE19, X7S, 50V, or GRM155R61H104KE19, X5R, 50V), which have an ESR $< 0.1\text{ohms}$ at 100kHz. The GRM155C71H104KE19 capacitor is the best choice based on ESR value and DC bias effects. If another capacitor is chosen, inspecting the ESR vs. Frequency curve of the manufacturer's capacitor datasheet is necessary to compare ESR characteristics as well as the DC bias effects on the capacitor value. Adding non-populated (NP) component placement (C10) is advised if the additional capacitance is needed for a particular Rx coil.

8. Input Capacitor (VRECT Capacitors)

The LDO input capacitors (VRECT capacitors) should be located as close as possible to the VRECT pins and ground (PGND). Ceramic capacitors are recommended for their low ESR and small profile.

9. Output Capacitor (VOUT Capacitors)

The output capacitor connection to the ground pins (PGND) should be made as short as practical for maximum device performance. Because the LDO is designed to function with very low ESR capacitors, a ceramic capacitor is recommended for the best performance. For better transient response, the total amount of output capacitance should be increased to meet the output voltage variation target of the application (VRECT capacitance may need to be increased as well).

10. LDO1P5 Capacitor

The RA9530 has an internal LDO regulator that must have at least a $1\mu\text{F}$ to $2.2\mu\text{F}$ capacitor connected from the LDO1P5 pin to PGND. This capacitor should be as close as possible to the LDO1P5 pin with a close GND connection. A $0.1\mu\text{F}$ capacitor in a 0201 or 0402 size package can be added for improved high-frequency decoupling of the LDO1P5 power rail because this voltage powers the internal ARM Cortex-M0 processor.

11. LDO5P0 Capacitor

The RA9530 has an internal LDO regulator that must have at least a $1\mu\text{F}$ to $2.2\mu\text{F}$ capacitor connected from the LDO5P0 pin to PGND. This capacitor should be as close as possible to the LDO5P0 pin with a close PGND connection. A $0.1\mu\text{F}$ capacitor in a 0201 or 0402 size package can be added for improved high-frequency decoupling of the LDO5P0 power rail because this voltage powers the internal ADC and UVLO circuits.

For additional power savings at higher input voltages, an external 5V supply should be connected to supply power to the RA9530 via the LDO5P0 pin. The applied voltage to this pin must be > LDO5P0 regular output voltage to power the low-voltage circuitry from the external 5V supply, while the external 5V supply should be between 5.2V and 5.5V.

12. PCLAMP Connection

The RA9530 has an internal automatic DC clamping feature to protect the device from events that cause high voltages to occur on the AC or DC side of the rectifier. The clamping engages by the VRECT connection to the PCLAMP pin. The VRECT node must be connected to the PCLAMP pin at all times during Rx mode operation. For space-constrained designs, the PCLAMP pin can be directly connected to the VRECT node for 5W or lower power operation.

Also, there is an option for external FET and resistor clamping by the use of the ECLAMP_DRV pin which can output 5V to drive the gate of external MOSFET. This output is synchronized with the internal PCLAMP signal. ECLAMP_DRV can provide additional clamping capability as needed and there is no thermal increase in the IC side because clamping energy is consumed in external components.

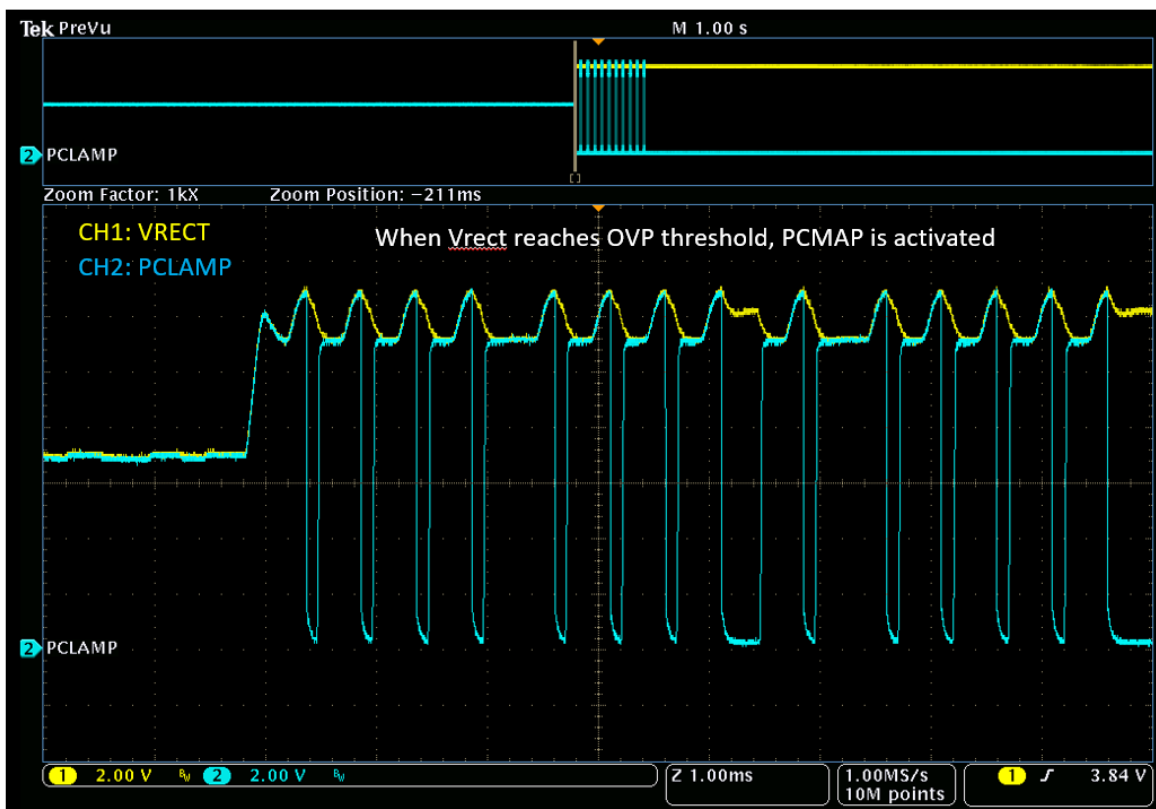

Figure 36. PCLAMP Operation at OVP Condition in BPP Mode

13. GPIO Pins

The RA9530 has general-purpose input-output (GPIO) pins. The OD0-OD4 and GP0-GP6 pins are all multi-functional. OD0-OD4 pins have an open-drained structure and GP0-GP6 pins have a push-pull structure. In the default firmware used in the evaluation board the GPIO pins are given specific functions to meet broad customer requirements. Below pin descriptions explains the specific functions allocated to GPIO pins

13.1 OD0/SCL Pin

The OD0 pin has a digital function open-drain structure. It is assigned to SCL of the I2C function for the serial interface between the AP and the RA9530. An external pull-up register on the SCL line is required for I2C communication and 1.8V power is pulled up in RA9530-R demo board. OD0 can operate up to 5V.

13.2 OD1/SDA Pin

The OD1 pin is set as a digital function open-drain structure. It is assigned to the SDA function of the I2C serial interface bus between the AP and the RA9530. An external pull-up resistor on the SDA line is required for I2C communication and 1.8V power is pulled up in RA9530-R demo board. OD1 can operate up to 5V.

13.3 OD2/nINT Pin

The OD2 pin is set as a digital function open-drain structure. It is assigned as the nINT signal for interrupt notification to the AP. nINT pin indicates a major change of states or error modes such as over-current, over-voltage, or over-temperature event. Connect this pin to the AP I/O voltage rail using an external pull-up resistor. The RA9530 drives this pin LOW to notify the AP of status changes.

13.4 OD4/INHIBIT(SLEEP)

The OD4/SLEEP pin is a digital input referenced to VDDIO. When the SLEEP pin is low, the Rx mode is enabled. Pulling the SLEEP pin high will prevent the RA9530 from connecting to the transmitter. The AP can use this pin to safely enable and disable the wireless power transfer function with proper VRECT node protections. If this pin is driven high in the power transfer phase, the RA9530 will send an End Power Transfer packet to the transmitter and wireless power transfer will be disabled while Vrect protection is alive.

13.5 GP0/PWRGD Pin

The GP0 pin is a digital output referenced to VDDIO. The AP can use the power good signal to turn on the charging connection indicator or other system functions. Power good (PWRGD) pin is low by default. In BPP mode, the power good pin is output high when MLDO is enabled. In EPP mode, the power good pin is high at the end of the negotiation phase by default. It can be configured to be high when MLDO Vout is enabled. If the PWRGD function is not required, pull down the GP0 pin to the ground with 100k~300kOhm.

13.6 GP2/TX_EN

The GP2 pin is a digital input referenced to VDDIO. If GP2 is pulled up by VDDIO, TRx mode starts working automatically when external power is connected to the VOUT pin. If GP2 (TX_EN) is not used, directly connect the GP2 pin to ground.

13.7 Unused GP/OD Pin

An unused GP pin is required to be connected to ground and OD pin is connected to VDDIO. Floating is not recommended.

14. Foreign Object Detection

When metallic objects are exposed to an alternating magnetic field, eddy currents cause such objects to heat up. Examples of such parasitic metal objects are coins, keys, paper clips, etc. The amount of heating depends on the strength of the coupled magnetic field, as well as the characteristics of the object, such as its resistivity, size, and shape. In a wireless power transfer system, the heating manifests itself as a power loss, and therefore a reduction in power-transfer efficiency. Moreover, if no appropriate measures are taken, the heating could be sufficient that the foreign object could become heated to an unsafe temperature.

In the Extended Power Profile, there are two methods of foreign object detection (FOD). One is by measuring the system quality factor before entering the power transfer phase, and the other is to measure the power loss

difference between the received power and the transmitted power during the power transfer phase. Before entering the power transfer phase, the RA9530 sends a reference Q-factor (default 30) in the negotiation phase. The transmitter measures the Q-factor on its coil and compares it with the reference Q-factor provided by the RA9530. If the difference is large, the transmitter presumes that there is a foreign object (FO) between the Tx and Rx and shuts down. The power loss foreign object detection method is used in both the Extended Power Profile (EPP) and the Basic Power Profile (BPP) modes power transfer phase. During the power transfer phase, the RA9530 continuously sends to the transmitter the amount of power received using the Received Power Packet (RPP). The transmitter will compare the RPP packet information received from the receiver with its measured transmitted power. If there is a significant difference the transmitter presumes that there is a foreign object (FO) between Tx and Rx that is absorbing the transmitted power and will stop the power transfer to avoid heating of FO.

14.1 FOD Parameters in Receiver Mode

For a WPC power loss foreign object detection to function effectively, the receiver must account and compensate for all of their known losses. Such losses, for example, could be due to resistive losses or nearby metals that are part of the receiver. Because the system accurately measures its power and accounts for all known losses, it can thereby detect foreign objects because they cause an unknown loss. The WPC specification requires that a power receiver must report to the power transmitter its received power (PPR) in an RPP. The maximum value of the received power accuracy $P\Delta$ depends on the maximum power of the power receiver as defined in the following table.

The power receiver must determine its PPR with an accuracy of $\pm P\Delta$, and report its received power as $PRECEIVED = PPR + P\Delta$. This means that the reported received power is always greater than or equal to the transmitted power (PPT) if there is no foreign object (FO) present on the interface surface.

Table 2. Recommended Maximum Estimated Power Loss

Maximum Power (W)	Maximum $P\Delta$ (mW)
5	350
10	500
15	750

The compensation algorithm includes parameter values that are programmable either by an internal register or customer configuration table in MTP. Programmability is necessary so that the calibration settings can be optimized to match the power transfer characteristics of each particular WPC system to include the power losses of the transmit and receive coils, battery, shielding, and case materials under no-load to full-load conditions. The values are based on the comparison of the received power against a reference power curve so that any foreign object can be sensed when the received power is different than the expected system power.

FOD parameters consist of eight sections. Each section is divided by output current and consists of gain and offset to compensate for Rx internal power loss; each section is also adjusted for Reported Rx power. The following comprises the Rx load current ranges for the FOD sections:

- FOD section [0] is from 100mA to section 0 current in EPP. From 0mA to section0 current in BPP.
- FOD section [1] is not used in EPP. In BPP it is from section 0 current to 380mA.
- FOD section [2] is from section 0 current to 510mA in EPP. In BPP it is from 380mA to 510mA.
- FOD section [3] is from 510mA to 670mA.
- FOD section [4] is from 670mA to 870mA.
- FOD section [5] is more than 870mA.
- FOD section [6] is used for diode mode, current 0mA to 100mA in EPP. BPP does not have diode mode.

Section 0 current is the point where the internal rectifier changes the bridge configuration from half-bridge to full-bridge. In the default configuration, if VOUT is set to less than 7V, the section0 current is 280mA. If Voutset is higher than 7V, the section0 current is 380mA. There is around $\pm 30\text{mA}$ load current hysteresis for changing the FOD sections. These settings can be changed using the *RA9530-R Wireless Power Pro GUI*.

The formula of Rx Reported Power is:

$$Rx\ Reported\ Power[0..5] = Power(Rx\ delivered\ power) * FOD\ Gain[0 \dots 5] + Offset[0..5]$$

Place the receiver with the RA9530 on the Nok9 FOD transmitter. Ramp the current on the output of the RA9530 in steps of 50mA to 100mA and monitor power difference between the Nok9 transmitted power and the receiver reported power value. The difference should be within maximum Power loss delta in above Power lossTable. If the difference exceeds the maximum power loss delta, adjust the FOD gain or FOD offset of that particular output current section to bring the difference back to within range. The AP can modify the FOD gain and FOD offset by writing to the Foreign Object Detection Customer Registers (0x68-0x77). In the final product, the AP can use the VRECTON as a trigger to update the FOD registers.

14.2 FOD Parameters in Transmitter Mode

For a WPC power loss foreign object detection to function effectively, the transmitter must set the FOD threshold at a reasonable value by accounting for all its known losses such as Coil resistance loss and losses because of metal around the coil integrated into the product. In the power transfer phase, the RA9530 will continuously calculate the difference between its measured transmitted power and RPP packet information received from the receiver. If the difference is higher than the FOD threshold, the RA9530 presumes that there is a foreign object (FO) between Tx and Rx that is absorbing the transmitted power and will stop the power transfer to avoid heating the FO.

The FOD threshold value changes based on the Received Power Packet value (RPP) from the receiver:

- The FodSegThd, FodThdH, and FodThdL are configurable by config table in MTP using the *RA9530-R Wireless Power Pro GUI*
- FOD criteria: FOD threshold > Transmitted Power (PPT) – Received Power (RPP)

15. I²C Function

The RA9530 uses the standard I²C slave implementation protocol to communicate with a host Application Processor (AP) or other I2C peripherals. The I2C address is 0x3B.

The AP can write to only the registers that are marked as Read/Write (RW). Registers marked as Read Only (R) should never be sent a Write command. Likewise, register locations marked Reserved should not receive a Write command. When writing to a RW register that contains a combination of RW fields and reserved fields, a read-modify-write should be performed to the intended bit/field only. All other bits, including reserved bits should “not” be modified.

16. Board Design

This section contains board design information about the RA9530-R EVK demo board (Rev1.0).

16.1 Schematic Diagram

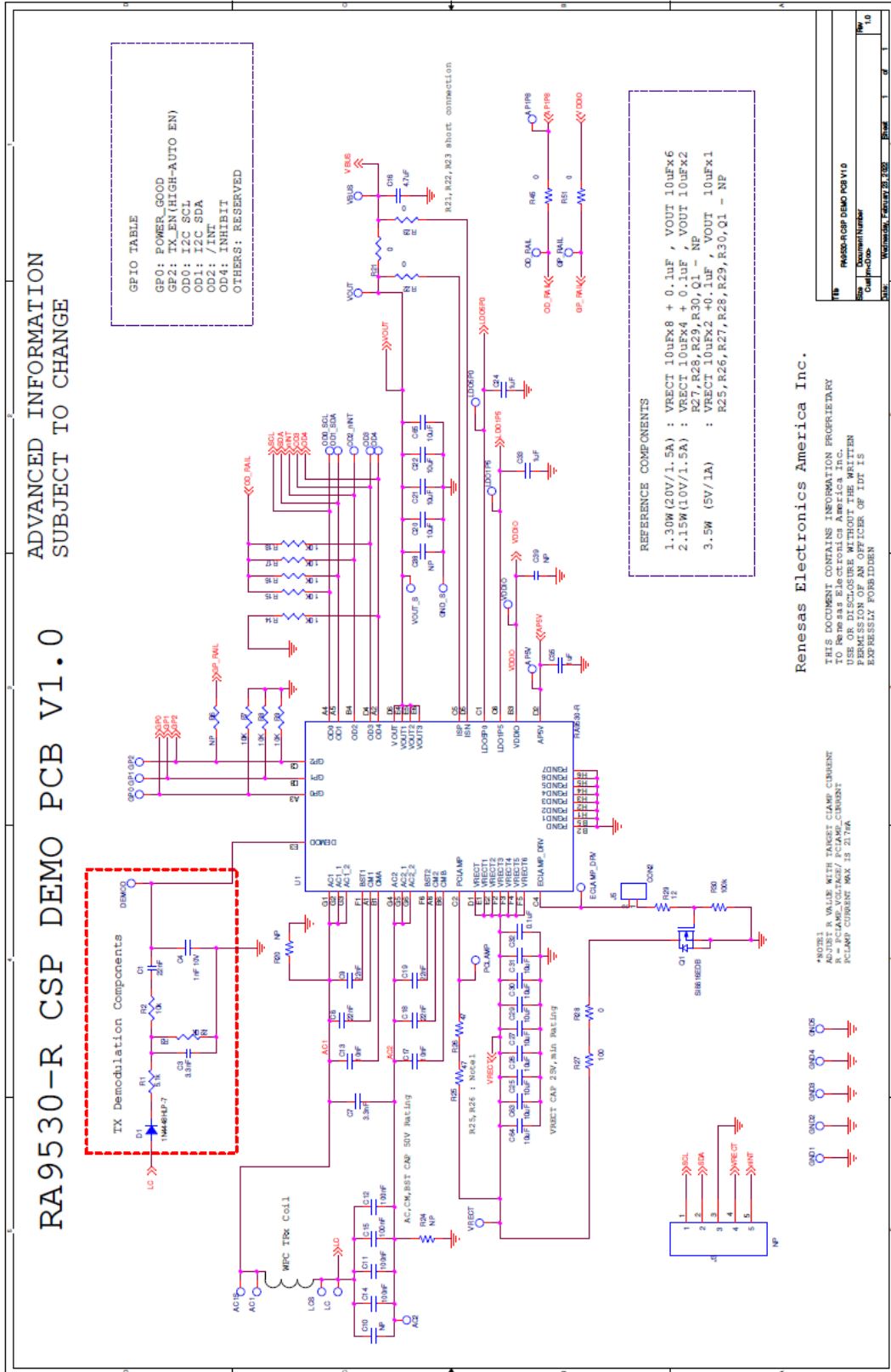

16.2 Bill of Materials

Item	Qty	Reference	Part	PCB Footprint	Part Number
1	2	AC1,LC	NP	test_pt_sm_135x70	NP
2	3	AC1S,AC2,LCS	NP	test_pt70_52d	5010
3	10	AP5V,LDO1P5,LDO5P0,VIN_OK,VDDIO,POI,INT_CP,EN_CP,CPOUT_S,AVDD	NP	tp_sm_45cir	NP
4	5	Reg18,AP1P8,OD_RAIL,GP_RAIL,PCLAMP	NP	test_pt70_52d	5013
5	1	CD_IN	5013	TEST_PT70_52D	5013
6	4	CFLYBT,CFLYBB,CFLYAT,CFLYAB	NP	tp_sm_45cir	SMD_Pad_Only
7	7	PGND1,GND1,GND2,VRECT,VOUT,VBUS,CPOUT	5015	test_pt_sm_135x70	5015
8	3	C1,C8,C18	22nF	402	GRM155R71H223 KA12D
9	3	C2,C5,C6	NP	402	CL05B102JB5NNN C
10	2	C3,C7	3.3nF	402	CL05B332KB5NNN C
11	1	C4	1nF 10V	201	100R05W102KV4T
12	2	C9,C19	22nF	0402_typ	GRM155R71H223 KA12D
13	1	C10	NP	402	GRM155R61H104 KE19D
14	4	C11,C12,C14,C15	100nF	402	GRM155R61H104 KE19D
15	2	C13,C17	10nF	402	CGA2B3X5R1H103 M050BB
16	1	C16	4.7uF	603	GRM188R6YA475 KE15
17	12	C20,C21,C22,C25,C26,C27,C29,C30,C31,C63,C64,C65	10uF	0402_0603_0805	GRM21BR6YA106 KE43L
18	1	C23	NP	402	GRM155C71A225K E11D
19	3	C24,C33,C35	1uF	201	GRM033C81A105 ME05D
20	3	C34,C36,C37	NP	201	GRM033C81A105 ME05D
21	1	C28	NP	cap_pol_3p5x2p8m m	T521T685M035AP E090
22	2	C52,C54	10uF	603	GRM188R6YA106 MA73D
23	2	C32,C53	0.1uF	201	GRM033R6YA104 KE14D
24	1	C38	NP	201	GRM033R6YA104 KE14D

Item	Qty	Reference	Part	PCB Footprint	Part Number
25	1	C39	NP	402	GRM155R71H223 KA12D
26	2	C40,C62	NP	603	CL10A226MO7JZN C
27	5	C41,C42,C55,C58,C61	22uF 16V	603	CL10A226MO7JZN C
28	6	C43,C44,C51,C56,C59,C60	100nF 10V	201	CL03A104MP3NN NC
29	1	C45	4.7uF 35V	603	CL10A475KL8NRN C
30	3	C46,C47,C48	2.2uF 35V	0402_typ	GRM155R6YA225 ME1D
31	1	C49	100pF	201	GRM0335C1H101J A01D
32	1	C50	NP	Cap_pol_2p0x1p25 mm	T58W9105M035C0 500
33	1	C57	2.2uF	201	CL03A225MP3CR NC
34	2	ECLAMP_DRV,DEMODO	NP	test_pt70_52d	5013
35	1	D1	DIODE	dfn1006_2ld_diode	1N4448HLP-7
36	2	D2,D3	NP	402	ACPDQC24VE-HF
37	2	VOUT_S,GND_S	TP	test_pt70_52d	61300111121
38	3	GND3,GND4,GND5	PTH_TP	test_pt70_52d	5011
39	8	OD1_SDA,GP1,OD2_nINT,GP2,OD3,OD4,OD0_SCL,GP0	PTH_TP	tp_sm_45cir	NP
40	1	J1	Header15	Header15	TSW-115-14-T-S
41	1	J2	NP	jumper2pin01in	68000-102HLF
42	1	J3	NP	header_1x5_0p1Pitc h60p42d	901200765
43	1	J4	NP	molex_12pin_FPC_ conn	52207-1233
44	1	J5	CON2	header_1x2_pitch50 _28d	GRPB021VWVN- RC
45	1	J7	HEADER 3	header_1x3_0p1Pitc h60p42d	68000-203HLF
46	2	PGND2,PGND3	NP	test_pt90_65d	5011
47	1	Q1	Si8816EDB	BGA-4	SI8816EDB-T2-E1
48	1	R1	5.1k	201	ERJ-1GEJ512C
49	1	R2	10k	201	RC0201JR-0710KL
50	1	R3	220k	402	CRCW0402220KF KED
51	8	R4,R5,R6,R10,R11,R12,R13,R19	NP	402	RC1005F103CS
52	8	R7,R8,R9,R14,R15,R16,R17,R18	10K	402	RC1005F103CS

Item	Qty	Reference	Part	PCB Footprint	Part Number
53	2	R20,R24	NP	402	RC0402JR-07100KL
54	1	R21	0	603	RC0603JR-070RL
55	2	R22,R23	0	402	RC0402FR-070RL
56	2	R25,R26	47	805	ERJ-P6WJ470V
57	1	R27	100	0402_0603_0805	ERJ-P06J101V
58	1	R28	0	805	RMCF0805ZT0R00
59	1	R29	12	402	RC0402JR-0712RL
60	1	R30	100K	402	RC0402JR-07100KL
61	18	R31,R32,R33,R34,R35,R36,R37,R38,R39,R40,R45,R51,R57,R58,R63,R64,R65,R66	0	402	RMCF0402ZT0R00
62	6	R42,R47,R67,R68,R69,R70	NP	402	RMCF0402ZT0R00
63	6	R41,R43,R44,R46,R48,R49	NP	402	RC0402JR-130RL
64	1	R50	NP	201	ERJ-1GEF10R0C
65	3	R52,R53,R54	220k	201	AC0201FR-07220KL
66	2	R55,R56	NP	603	RMCF0603ZT0R00
67	2	R59,R62	NP	402	RMCF0402ZT0R00
68	2	R60,R61	2.2k	402	CR0402-JW-222GLF
69	1	U1	RA9530	RA9530CSP	RA9530
70	1	U2	NP	SC70-5	ISL9008AIECZ-T
71	1	U3	NP	csp48_2p645x3p44 5_0p4mm	LN8282

16.3 Board Layout

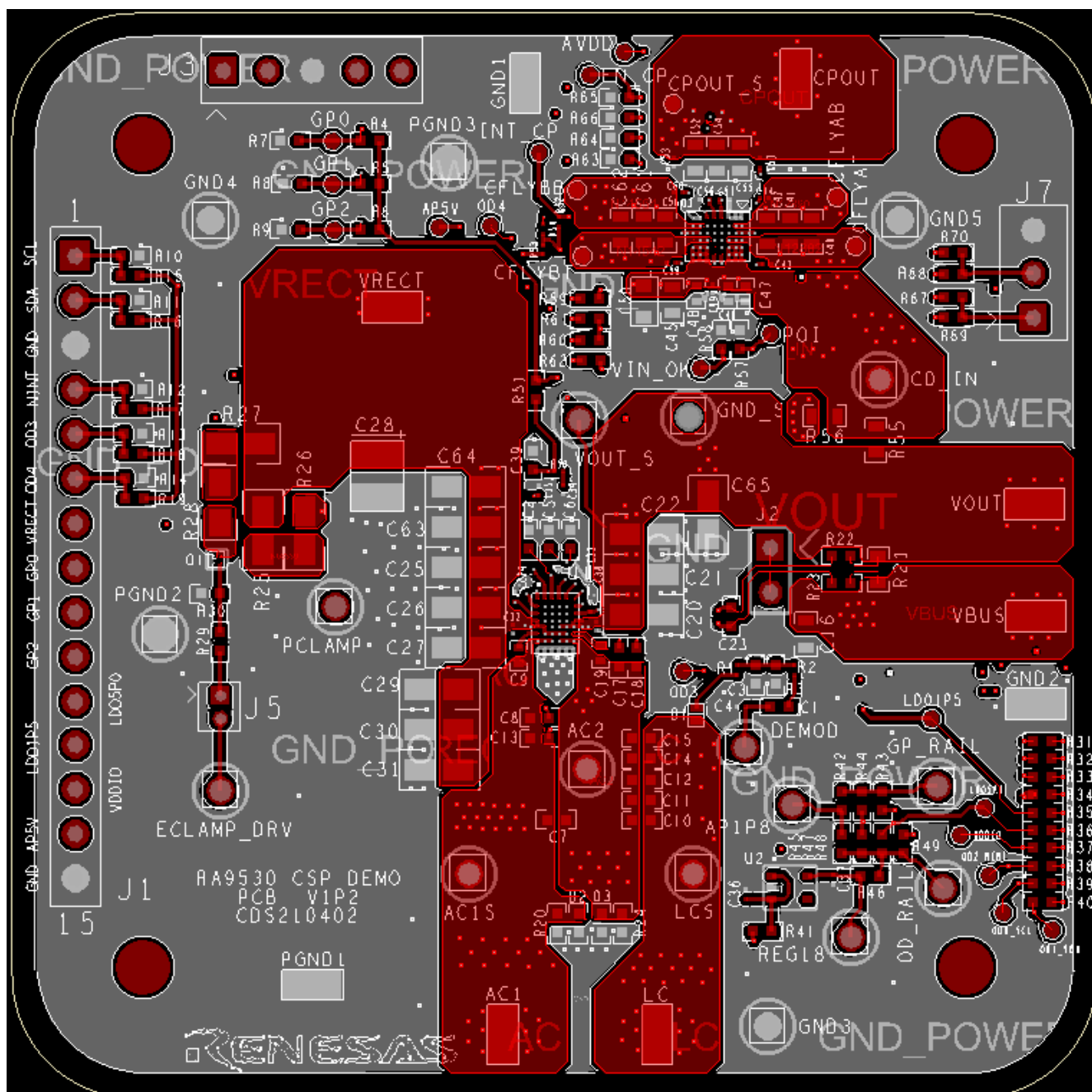

Figure 37. Top and Top Silkscreen Layer

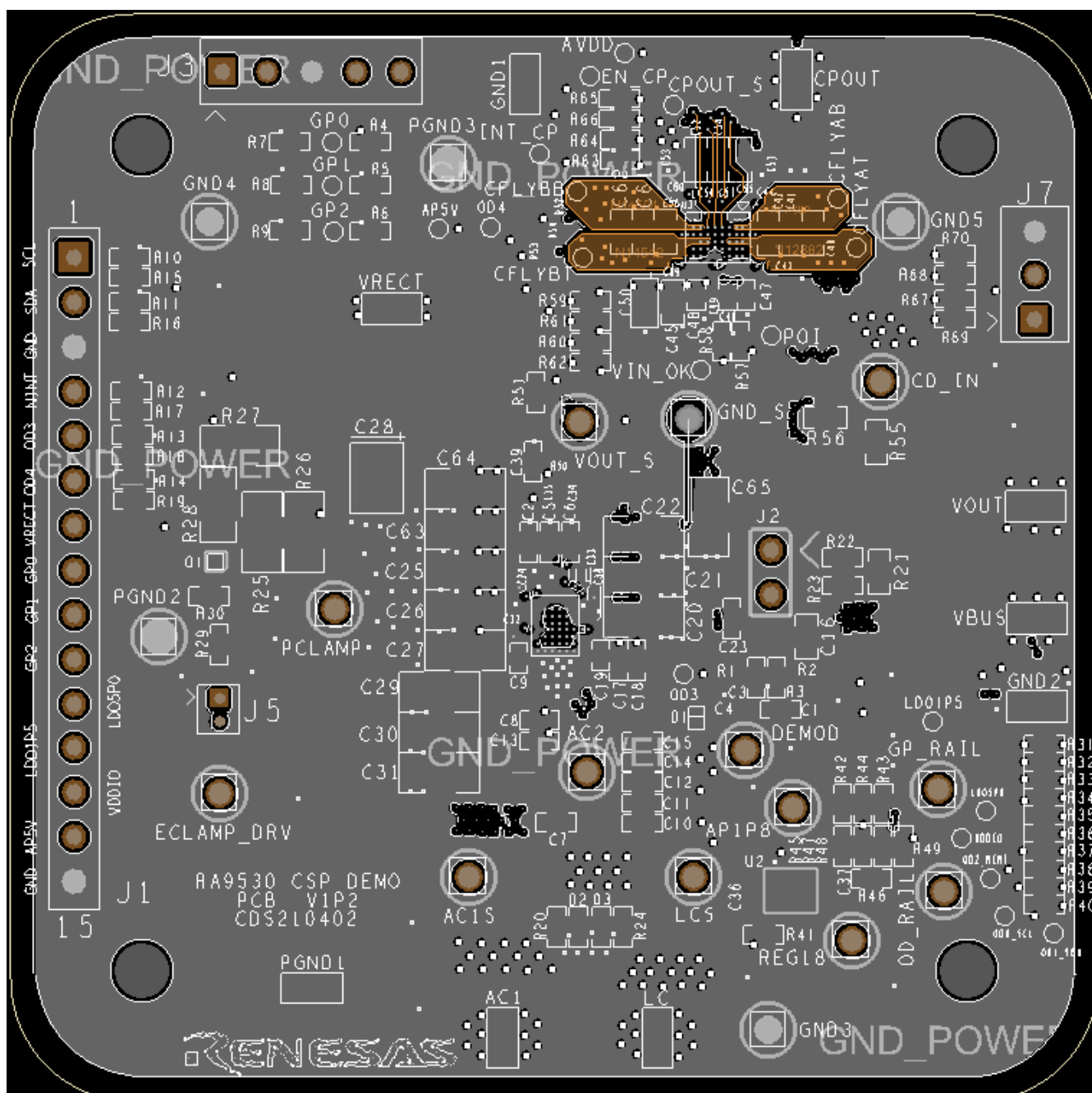

Figure 38. Inner1 Layer (GND Layer)

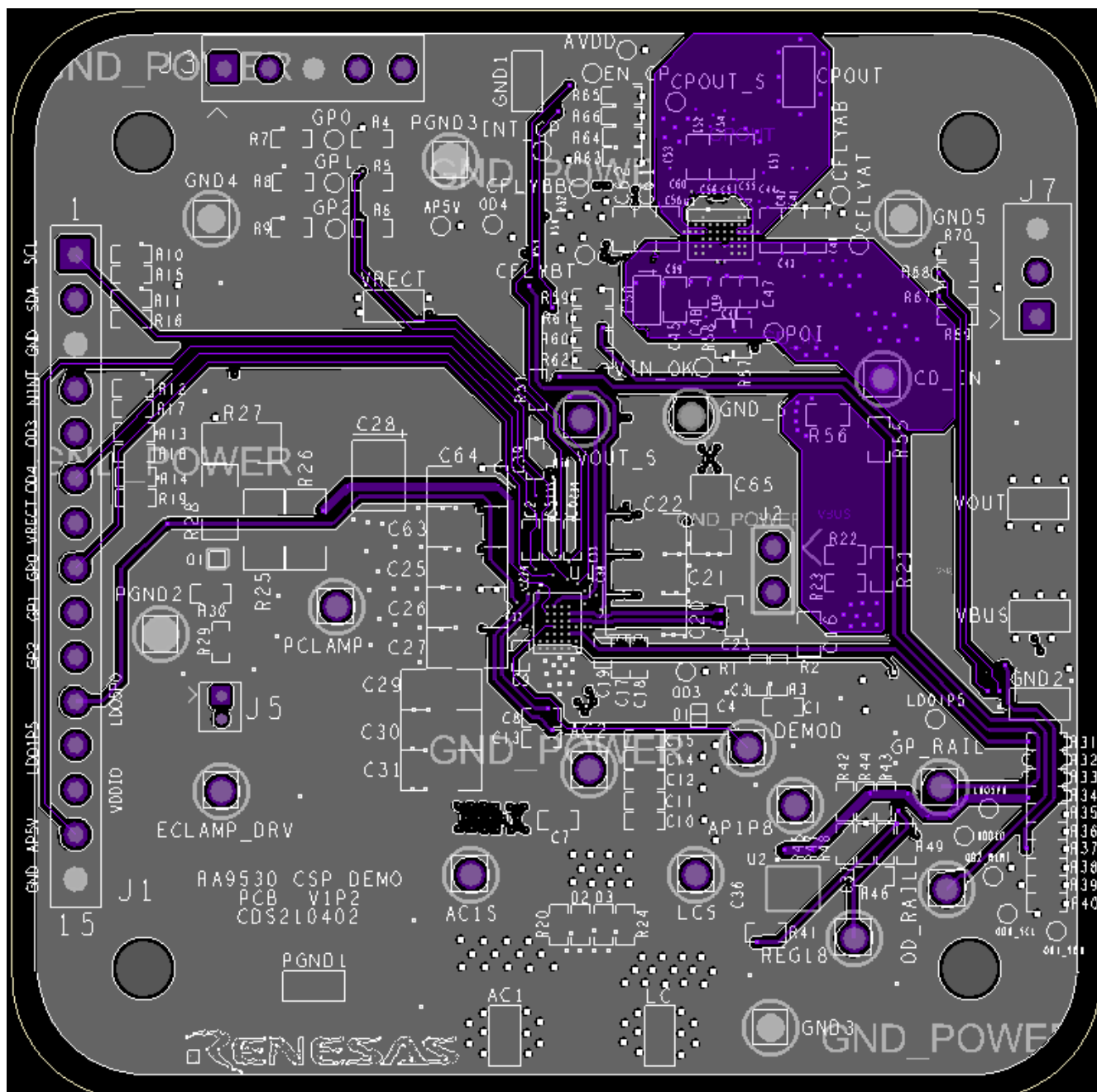

Figure 39. Inner2 Layer (POWER/Signal/GND Layer)

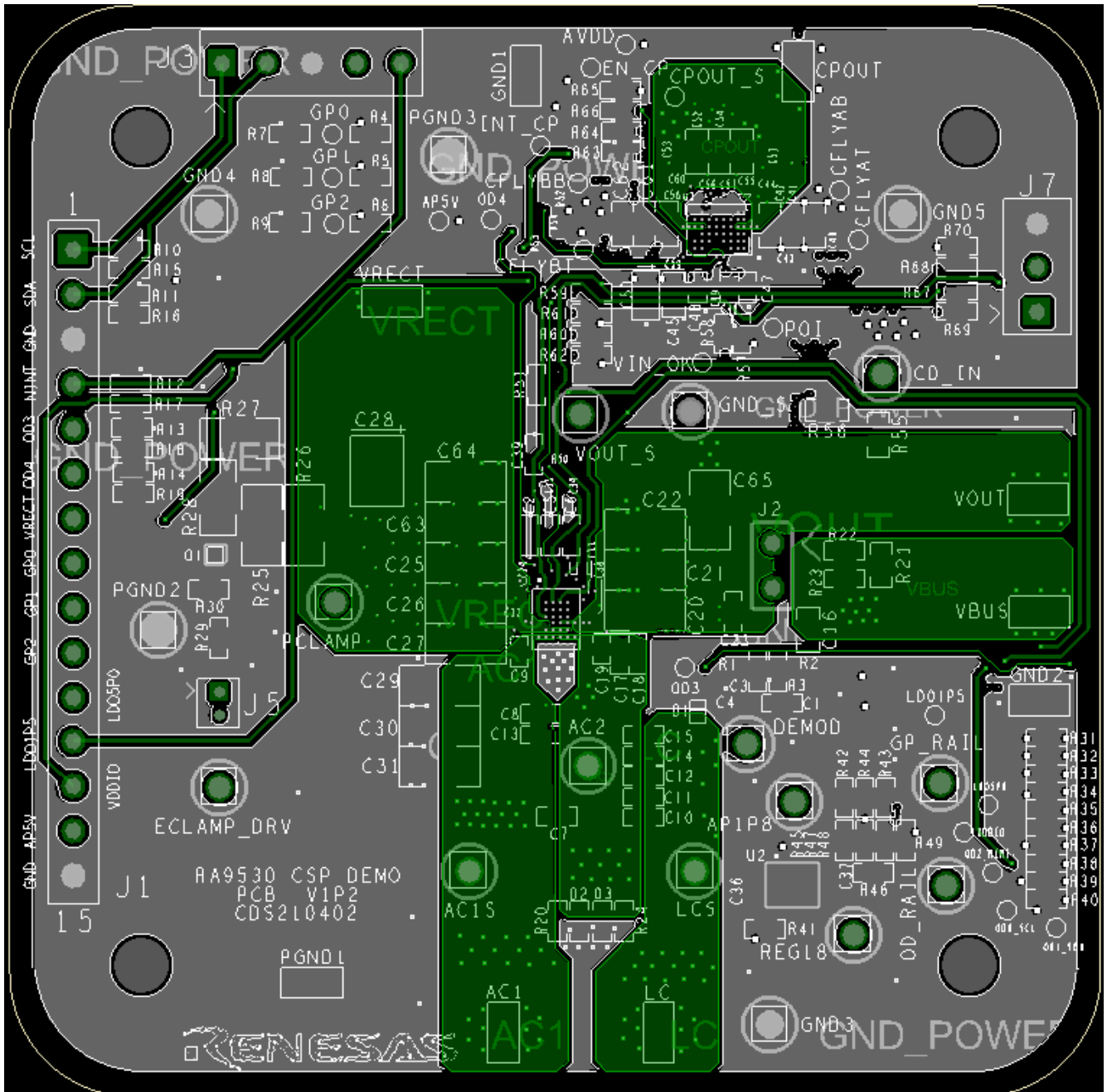

Figure 40. Inner3 Layer (POWER/Signal/GND Layer)

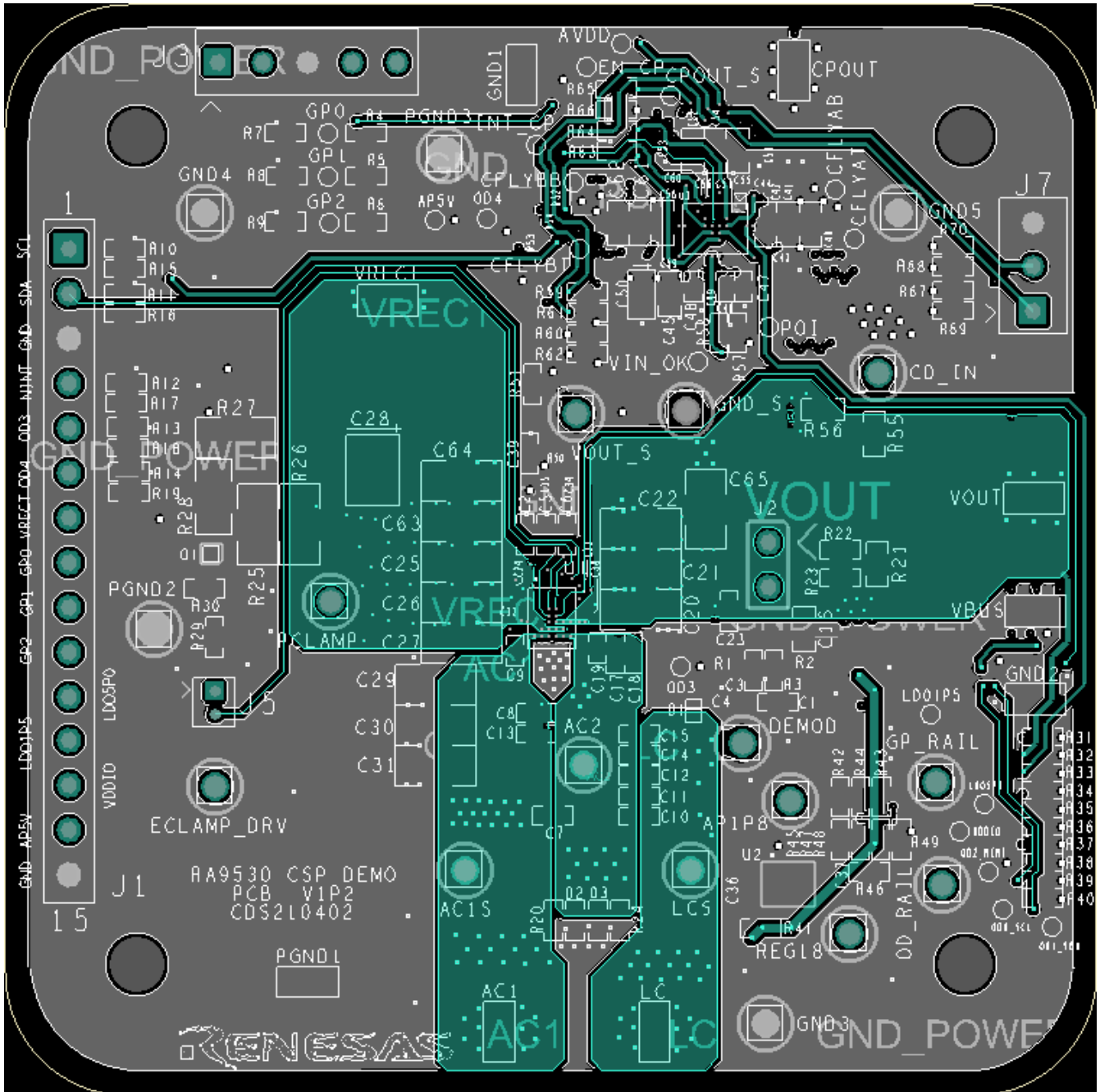

Figure 41. Inner4 Layer (POWER/Signal/GND Layer)

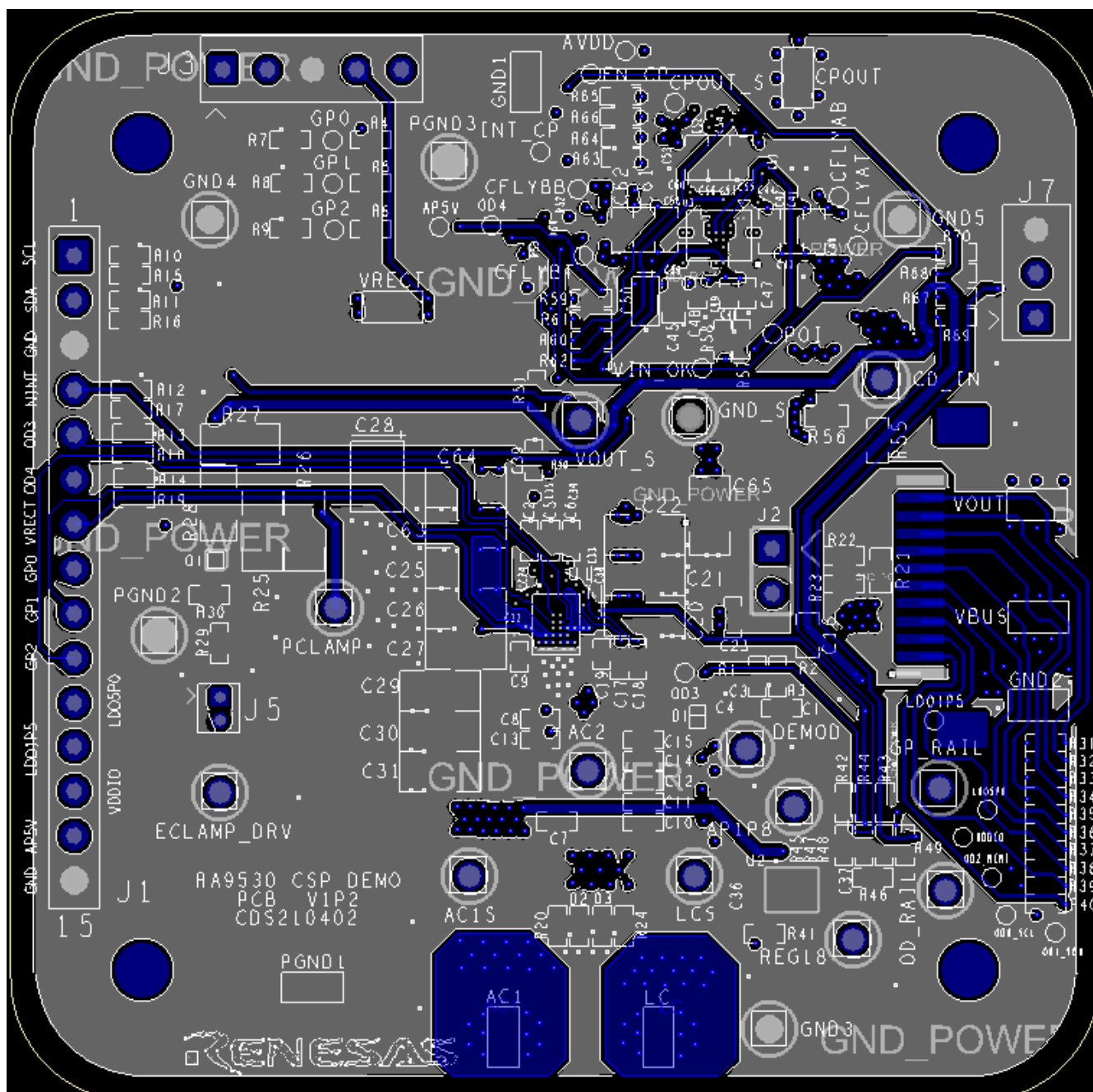

Figure 42. Bottom Layer

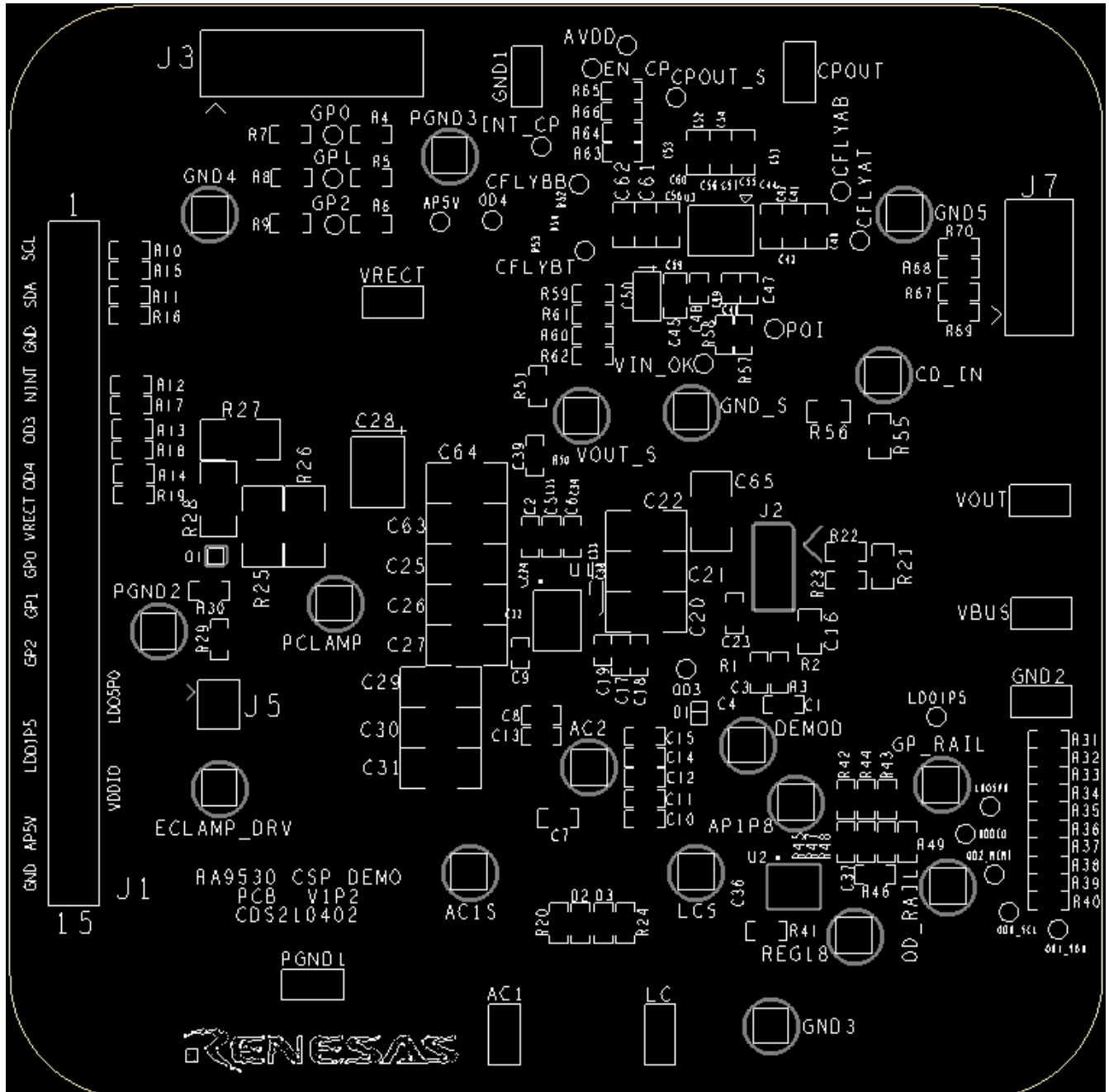

Figure 43. Assembly Drawing

17. Device Registers

The RA9530 uses the standard I2C slave implementation protocol to communicate with a host AP or other I2C peripherals. The communication protocol is implemented by using 8 bits for data and 16 bits for addresses. The default slave address of the RA9530 is 0x3B (high 7 bits).

When writing to the device, care should be taken to only write to registers marked exclusively as Read/Write (RW). Registers marked as Read Only (R) should never be sent a Write command or unexpected behavior may occur. In addition, register locations marked Reserved should not receive a Write command. When writing to a RW register that contains a combination of RW fields and reserved fields, a read-modify-write should be performed to the intended bit/field only. All other bits/field, including reserved bits/fields, should “not” be modified.

The following section contains a comprehensive list of address locations, field names, available operations (R or RW), default values, and functional descriptions of all internally accessible registers contained within the device.

17.1 Common Registers

17.1.1. Chip Type (0x0000, 16-Bit)

Bit	Field Name	RW	Default Value	Description
15:0	Chip Type	R	0x9530	Chip ID byte

17.1.2. Hardware Revision (0x0002, 8-Bit)

Bit	Field Name	RW	Default Value	Description
7:0	HW Rev	R	0x02	Hardware revision

17.1.3. Customer Code (0x0003, 8-Bit)

Bit	Field Name	RW	Default Value	Description
7:0	Customer Code	R	0x00	Customer Code

17.1.4. Firmware Beta Revision (0x0017, 8-Bit)

Bit	Field Name	RW	Default Value	Description
7:0	FW Beta Rev	RW	-	FW Beta Revision for Debug releases

17.1.5. Firmware Minor Revision (0x001C, 16-Bit)

Bit	Field Name	RW	Default Value	Description
15:0	FW Minor Rev	RW	-	Minor revision of firmware

17.1.6. Firmware Major Revision (0x001E, 16-Bit)

Bit	Field Name	RW	Default Value	Description
15:0	FW Major Rev	RW	-	Major revision of firmware

17.1.7. WPC Manufacturer ID (0x004A, 16-Bit)

Bit	Field Name	RW	Default Value	Description
15:0	WPC Manufacturer ID	R	-	WPC Manufacturer ID

The following table shows the WPC specified table for the packet that is being sent by Rx during ID and Configuration phase.

	b ₇	b ₆	b ₅	b ₄	b ₃	b ₂	b ₁	b ₀
B ₀	Major Version				Minor Version			
B ₁	(msb) (lsb)							
B ₂								
B ₃	Ext	(msb) (lsb)						
...								
B ₆								

17.1.8. Firmware Date Code (0x00C4 - 0x00CF, 12 Bytes)

Address	Field Name	RW	Default Value	Description		
0xCF	FW Date Code [96:88]	RW	-	Date Code of firmware in NVM Data Encoding Format: ASCII code E.g.,) Dec 10 2015(11:53:41)		
0xCE	FW Date Code [87:80]	RW	-			
0xCD	FW Date Code [79:72]	RW	-	Register	Value	ASCII
				0xCF	00	Null
0xCC	FW Date Code [71:64]	RW	-	0xCE	35	5
				0xCD	31	1
0xCB	FW Date Code [63:56]	RW	-	0xCC	30	0
				0xCB	32	2
0xCA	FW Date Code [55:48]	RW	-	0xCA	20	Space
				0xC9	30	0
0xC9	FW Date Code [47:40]	RW	-	0xC8	31	1
				0xC7	20	Space
0xC8	FW Date Code [39:32]	RW	-	0xC6	63	c
				0xC5	65	e
0xC7	FW Date Code [31:24]	RW	-	0xC4	44	D
0xC6	FW Date Code [23:16]	RW	-			
0xC5	FW Date Code [15:8]	RW	-			
0xC4	FW Date Code [7:0]	RW	-			

17.1.9. Firmware Time Code (0x00D4 - 0x00DB, 8 Bytes)

Address	Field Name	RW	Default Value	Description		
0xDB	FW Time Code [55:48]	RW	-	Time Code of firmware in NVM Data Encoding Format: ASCII code Ex: Dec 10 2015(11:53:41)		
0xDA	FW Time Code [47:40]	RW	-			
0xD9	FW Time Code [39:32]	RW	-	Register	Value	ASCII
				0xDB	31	1
0xD8	FW Time Code [31:24]	RW	-	0xDA	34	4
				0xD9	3A	:
0xD7	FW Time Code [15:8]	RW	-	0xD8	33	3
				0xD7	35	5
0xD6	FW Time Code [23:16]	RW	-	0xD6	3A	:
				0xD5	31	1
0xD5	FW Time Code [13:8]	RW	-	0xD4	31	1
0xD4	FW Time Code [7:0]	RW	-			

17.1.10. System Operating Mode Register (0x004D, 8-Bit)

Bit	Field Name	Mode	RW	Default Value	Description
7:0	System Mode	RX	R	-	0x80 – Back Powered, Indication that the chip is powered by VRECT or VOUT, but TX function is not enabled 0x09 – Extended WPC Mode 0x04 – TRx Mode 0x01 – Basic WPC Mode 0x00 – AC Missing Mode Rest all values are Reserved

17.2 RX Mode Registers

17.2.1. System Interrupt Clear Register in RX Mode (0x0028 - 0x002B, 32-Bit)

Bit	Field Name	Mode	RW	Default Value	Description
31	ADT Error	RX	RW	0	AP writes 1 to clear the corresponding Interrupt Registers' bit and this bit is self-cleared to 0 (by M0) afterwards.
30	ADT Received	RX	RW	0	AP writes 1 to clear the corresponding Interrupt Registers' bit and this bit is self-cleared to 0 (by M0) afterwards.
29	ADT Sent	RX	RW	0	AP writes 1 to clear the corresponding Interrupt Registers' bit and this bit is self-cleared to 0 (by M0) afterwards.
28	RX EPP	RX	RW	0	AP writes 1 to clear the corresponding Interrupt Registers' bit and this bit is self-cleared to 0 (by M0) afterwards.
27	Reserved	-	-	-	Reserved
26	VRECT ON	RX	RW	0	AP writes 1 to clear the corresponding Interrupt Registers' bit and this bit is self-cleared to 0 (by M0) afterwards.
25	No I2C data Timeout	RX	RW	0	AP writes 1 to clear the corresponding Interrupt Registers' bit and this bit is self-cleared to 0 (by M0) afterwards.
24:23	Reserved	-	-	-	Reserved
22	BPP/EPP Check	RX	RW	0	AP writes 1 to clear the corresponding Interrupt Registers' bit and this bit is self-cleared to 0 (by M0) afterwards.
21	Power Loss OTP	RX	RW	0	AP writes 1 to clear the corresponding Interrupt Registers' bit and this bit is self-cleared to 0 (by M0) afterwards.
20	Over Current Fault	RX	RW	0	AP writes 1 to clear the corresponding Interrupt Registers' bit and this bit is self-cleared to 0 (by M0) afterwards.
19	Re-negotiation Fail	RX	RW	0	AP writes 1 to clear the corresponding Interrupt Registers' bit and this bit is self-cleared to 0 (by M0) afterwards.
18	Re-negotiation Success	RX	RW	0	AP writes 1 to clear the corresponding Interrupt Registers' bit and this bit is self-cleared to 0 (by M0) afterwards.
17	RPP Read	RX	RW	0	AP writes 1 to clear the corresponding Interrupt Registers' bit and this bit is self-cleared to 0 (by M0) afterwards.
16	AP 5V Disable	RX	RW	0	AP writes 1 to clear the corresponding Interrupt Registers' bit and this bit is self-cleared to 0 (by M0) afterwards.
15	Fast Charging Failure	RX	RW	0	AP writes 1 to clear the corresponding Interrupt Registers' bit and this bit is self-cleared to 0 (by M0) afterwards.
14	Sleep Mode	RX	RW	0	AP writes 1 to clear the corresponding Interrupt Registers' bit and this bit is self-cleared to 0 (by M0) afterwards.
13	ID Authentication Success	RX	RW	0	AP writes 1 to clear the corresponding Interrupt Registers' bit and this bit is self-cleared to 0 (by M0) afterwards.
12	ID Authentication Failure	RX	RW	0	AP writes 1 to clear the corresponding Interrupt Registers' bit and this bit is self-cleared to 0 (by M0) afterwards.

Bit	Field Name	Mode	RW	Default Value	Description
11	Back Channel Success	RX	RW	0	AP writes 1 to clear the corresponding Interrupt Registers' bit and this bit is self-cleared to 0 (by M0) afterwards.
10	Back Channel Timeout	RX	RW	0	AP writes 1 to clear the corresponding Interrupt Registers' bit and this bit is self-cleared to 0 (by M0) afterwards.
9	TX Authentication Success	RX	RW	0	AP writes 1 to clear the corresponding Interrupt Registers' bit and this bit is self-cleared to 0 (by M0) afterwards.
8	TX Authentication Failure	RX	RW	0	AP writes 1 to clear the corresponding Interrupt Registers' bit and this bit is self-cleared to 0 (by M0) afterwards.
7	LDO Disable	RX	RW	0	AP writes 1 to clear the corresponding Interrupt Registers' bit and this bit is self-cleared to 0 (by M0) afterwards.
6	LDO Enable	RX	RW	0	AP writes 1 to clear the corresponding Interrupt Registers' bit and this bit is self-cleared to 0 (by M0) afterwards.
5	Operation Mode Change	RX	RW	0	AP writes 1 to clear the corresponding Interrupt Registers' bit and this bit is self-cleared to 0 (by M0) afterwards.
4	TX Data Receive	RX	RW	0	AP writes 1 to clear the corresponding Interrupt Registers' bit and this bit is self-cleared to 0 (by M0) afterwards.
3	Fast Charging Success	RX	RW	0	AP writes 1 to clear the corresponding Interrupt Registers' bit and this bit is self-cleared to 0 (by M0) afterwards.
2	Over Temperature	RX	RW	0	AP writes 1 to clear the corresponding Interrupt Registers' bit and this bit is self-cleared to 0 (by M0) afterwards.
1	Over Voltage	RX	RW	0	AP writes 1 to clear the corresponding Interrupt Registers' bit and this bit is self-cleared to 0 (by M0) afterwards.
0	Over Current	RX	RW	0	AP writes 1 to clear the corresponding Interrupt Registers' bit and this bit is self-cleared to 0 (by M0) afterwards.

17.2.2. System Status Register in RX Mode (0x002C - 0x002F, 32-Bit)

Bit	Field Name	Mode	RW	Default Value	Description
31	ADT Error	RX	R	-	1 = ADT error occurs
30	ADT Received	RX	R	-	1 = ADT received
29	ADT Sent	RX	R	-	1 = ADT sends
28	RX EPP	RX	R	-	1 = Send RPP in EPP mode
27	Reserved	-	-	-	Reserved
26	VRECT ON	RX	R	-	1 = AC power is applied. The flag is set before the Configuration Packet. It is cleared on system reset or when power is removed. Interrupt event is generated on SET event
25	No I2C data Timeout	RX	RW	-	1 = No I2C data function timeout

Bit	Field Name	Mode	RW	Default Value	Description
24:23	Reserved	-	-	-	Reserved
22	BPP/EPP Check	RX	R	-	1 = BPP/EPP check
21	Power Loss OTP	RX	R	-	1 = Power Loss condition
20	Over Current Fault	RX	R	-	1 = Iout is close to Ilim value
19	Re-negotiation Fail	RX	R	-	1 = Renegotiation is failed.
18	Re-negotiation Success	RX	R	-	1 = Renegotiation is successful
17	RPP Read	RX	R	-	1 = Out of band communication is successful
16	AP 5V Disable	RX	R	-	1 = AP5V is disabled
15	Fast Charging Failure	RX	R	-	1 = Fast Charging condition is failed
14	Sleep Mode	RX	R	-	1 = Rx is in sleep mode
13	ID Authentication Success	RX	R	-	1 = ID authentication is passed
12	ID Authentication Failure	RX	R	-	1 = ID authentication is failed
11	Back Channel Success	RX	R	-	1 = Backchannel packet is received by Tx
10	Back Channel Timeout	RX	R	-	1 = Backchannel packet is sending failed
9	TX Authentication Success	RX	R	-	1 = Device authentication is passed
8	TX Authentication Failure	RX	R	-	1 = Device authentication is failed
7	LDO Disable	RX	R	-	1 = LDO is disabled
6	LDO Enable	RX	R	-	1 = LDO is enabled
5	Operation Mode Change	RX	R	-	1 = Operating mode is changed
4	TX Data Receive	RX	R	-	1 = Proprietary packet from Tx is received
3	Fast Charging Success	RX	R	-	1 = Fast Charging is successful
2	Over Temperature	RX	R	-	1 = Over Temperature condition

Bit	Field Name	Mode	RW	Default Value	Description
1	Over Voltage	RX	R	-	1 = Over Voltage condition
0	Over Current	RX	R	-	1 = Over Current Error condition

17.2.3. System Interrupt Register in RX Mode (0x0030 - 0x0033, 32-Bit)

Bit	Field Name	Mode	RW	Default Value	Description
31	ADT Error	RX	R	0	1 = ADT error happens. 0 = No such condition exists
30	ADT Received	RX	R	0	1 = ADT is received. 0 = No such condition exists
29	ADT Sent	RX	R	0	1 = ADT is sent 0 = No such condition exists
28	RX EPP	RX	R	0	1 = Send RPP in EPP mode 0 = No such condition exists
27	Reserved	-	-	0	Reserved
26	VRECT ON	RX	R	0	1 = AC power is applied. The flag is set before the Configuration Packet. It is cleared on system reset or when power is removed. Interrupt event is generated on SET event 0 = No such condition exists
25	No I2C data Timeout	RX	RW	0	1 = No I2C data function timeout 0 = No such condition exists
24:23	Reserved	-	-	0	Reserved
22	BPP/EPP Check	RX	R	0	1 = BPP/EPP Check 0 = No such condition exists
21	Power Loss OTP	RX	R	0	1 = Power Loss condition 0 = No such condition exists
20	Over Current Fault	RX	R	0	1 = Iout is close to Ilim value 0 = No such condition exists
19	Re-negotiation Fail	RX	R	0	1 = Re-negotiation is failed 0 = No such condition exists
18	Re-negotiation Success	RX	R	0	1 = Re-negotiation is successful 0 = No such condition exists
17	RPP Read	RX	R	0	1 = Out of band communication is successful 0 = No such condition exists
16	AP 5V Disable	RX	R	0	1 = AP5V is disabled 0 = No such condition exists
15	Fast Charging Failure	RX	R	0	1 = Fast Charging command is failed 0 = No such condition exists

Bit	Field Name	Mode	RW	Default Value	Description
14	Sleep Mode	RX	R	0	1 = Rx is in sleep mode 0 = No such condition exists
13	ID Authentication Success	RX	R	0	1 = ID authentication is passed 0 = No such condition exists
12	ID Authentication Failure	RX	R	0	1 = ID authentication is failed 0 = No such condition exists
11	Back Channel Success	RX	R	0	1 = Backchannel packet is received by Tx 0 = No such condition exists
10	Back Channel Timeout	RX	R	0	1 = Backchannel packet is sending failed 0 = No such condition exists
9	TX Authentication Success	RX	R	0	1 = Device authentication is passed 0 = No such condition exists
8	TX Authentication Failure	RX	R	0	1 = Device authentication is failed 0 = No such condition exists
7	LDO Disable	RX	R	0	1 = LDO is disabled 0 = No such condition exists
6	LDO Enable	RX	R	0	1 = LDO is enabled 0 = No such condition exists
5	Operation Mode Change	RX	R	0	1 = Operating mode is changed 0 = No such condition exists
4	TX Data Receive	RX	R	0	1 = Proprietary packet from Tx is received 0 = No such condition exists
3	Fast Charging Success	RX	R	0	1 = Fast Charging is successful 0 = No such condition exists
2	Over Temperature	RX	R	0	1 = Over Temperature condition 0 = No such condition exists
1	Over Voltage	RX	R	0	1 = Over Voltage condition 0 = No such condition exists
0	Over Current	RX	R	0	1 = Over Current Error condition 0 = No such condition exists

17.2.4. System Interrupt Enable Register in RX Mode (0x0034 - 0x0037, 32-Bit)

Bit	Field Name	Mode	RW	Default Value	Description
31	ADT Error	RX	RW	1	1 = Corresponding interrupt is enabled 0 = Corresponding interrupt is disabled
30	ADT Received	RX	RW	1	1 = Corresponding interrupt is enabled 0 = Corresponding interrupt is disabled
29	ADT Sent	RX	RW	1	1 = Corresponding interrupt is enabled 0 = Corresponding interrupt is disabled
28	RX EPP	RX	RW	1	1 = Corresponding interrupt is enabled 0 = Corresponding interrupt is disabled
27	Reserved	-	-	-	Reserved
26	VRECT ON	RX	RW	1	1 = Corresponding interrupt is enabled 0 = Corresponding interrupt is disabled
25	No I2C data Timeout	RX	RW	1	1 = Corresponding interrupt is enabled 0 = Corresponding interrupt is disabled
24:23	Reserved	-	-	-	Reserved
22	BPP/EPP Check	RX	RW	1	1 = Corresponding interrupt is enabled 0 = Corresponding interrupt is disabled
21	Power Loss OTP	RX	RW	1	1 = Corresponding interrupt is enabled 0 = Corresponding interrupt is disabled
20	Over Current Fault	RX	RW	1	1 = Corresponding interrupt is enabled 0 = Corresponding interrupt is disabled
19	Re-negotiation Fail	RX	R	1	1 = Corresponding interrupt is enabled 0 = Corresponding interrupt is disabled
18	Re-negotiation Success	RX	R	1	1 = Corresponding interrupt is enabled 0 = Corresponding interrupt is disabled
17	RPP Read	RX	RW	1	1 = Corresponding interrupt is enabled 0 = Corresponding interrupt is disabled
16	AP 5V Disable	RX	RW	1	1 = Corresponding interrupt is enabled 0 = Corresponding interrupt is disabled
15	Voltage Switch Failure	RX	RW	1	1 = Corresponding interrupt is enabled 0 = Corresponding interrupt is disabled
14	Sleep Mode	RX	RW	1	1 = Corresponding interrupt is enabled 0 = Corresponding interrupt is disabled
13	ID Authentication Success	RX	RW	1	1 = Corresponding interrupt is enabled 0 = Corresponding interrupt is disabled
12	ID Authentication Failure	RX	RW	1	1 = Corresponding interrupt is enabled 0 = Corresponding interrupt is disabled

Bit	Field Name	Mode	RW	Default Value	Description
11	Back Channel Success	RX	RW	1	1 = Corresponding interrupt is enabled 0 = Corresponding interrupt is disabled
10	Back Channel Timeout	RX	RW	1	1 = Corresponding interrupt is enabled 0 = Corresponding interrupt is disabled
9	TX Authentication Success	RX	RW	1	1 = Corresponding interrupt is enabled 0 = Corresponding interrupt is disabled
8	TX Authentication Failure	RX	RW	1	1 = Corresponding interrupt is enabled 0 = Corresponding interrupt is disabled
7	LDO Disable	RX	RW	1	1 = Corresponding interrupt is enabled 0 = Corresponding interrupt is disabled
6	LDO Enable	RX	RW	1	1 = Corresponding interrupt is enabled 0 = Corresponding interrupt is disabled
5	Operation Mode Change	RX	RW	1	1 = Corresponding interrupt is enabled 0 = Corresponding interrupt is disabled
4	TX Data Receive	RX	RW	1	1 = Corresponding interrupt is enabled 0 = Corresponding interrupt is disabled
3	Fast Charging Success	RX	RW	1	1 = Corresponding interrupt is enabled 0 = Corresponding interrupt is disabled
2	Over Temperature	RX	RW	1	1 = Corresponding interrupt is enabled 0 = Corresponding interrupt is disabled
1	Over Voltage	RX	RW	1	1 = Corresponding interrupt is enabled 0 = Corresponding interrupt is disabled
0	Over Current	RX	RW	1	1 = Corresponding interrupt is enabled 0 = Corresponding interrupt is disabled

17.2.5. Battery Charge Status Register (0x003A, 8-Bit)

Bit	Field Name	Mode	RW	Default Value	Description
7:0	Charge Status	RX	RW	0x00	In RX mode the AP writes this register with the value intended to be sent as payload to the Charge Status Packet. The FW does not verify or modify the value in any way. The value should be filled based on the following: 0x0 = Reserved 0x1 = Charge status packet sent with parameter = 1 (1%) 0x2 - Charge status packet send with parameter = 2 (2%) ... 0x64 - Charge status packet send with parameter = 100 (100%) 0x65 ~ 0xFE : Reserved 0xFF - No Battery Charge Device or Not Providing Charge Status Packet

Note: After writing to this register, Send Charge Status bit of Command Register (0x4E) needs to be set for transmission to begin.

17.2.6. End of Power Transfer Register in RX Mode (0x003B, 8-Bit)

Bit	Field Name	Mode	RW	Default Value	Description
7:0	EPT/EOC/EOP Reason	RX	RW	0x00	In RX mode the AP writes this register with the value intended to be sent as payload to the Charge Status Packet. The FW does not verify or modify the value in any way. A WPC End of Power Transfer packet/message will be sent with the following definition: 0 = WPC mode, unknown 1 = WPC mode, Charge Complete 2 = WPC mode, Internal Fault 3 = WPC mode, Over Temperature 4 = WPC mode, Over Voltage 5 = WPC mode, Over Current 6 = WPC mode, Battery Failure 7 = WPC mode, Re-Configuration 8 = WPC mode, No Response 10 = WPC mode, Negotiation Failure 11 = WPC mode, Restart Power All other values are reserved.

Note: After writing to this register, Send EPT bit of Command Register (0x4E) needs to be set for transmission to begin.

17.2.7. Vout ADC Reading (0x003C, 16-Bit)

Bit	Field Name	Mode	RW	Default Value	Description
15:0	VoutAdc	RX	R	0x00	Vout uncompensated raw ADC reading. Scaled as 12-bit number for 21V full scale.

17.2.8. Vout Set Register (0x003E, 16-Bit)

Bit	Field Name	Mode	RW	Default Value	Description
15:0	VOutSet	RX	RW	0x00DE (BPP) 0x02D7 (EPP)	Main LDO Vout set value. When default Vout is changed by AP through this register, target Vrect will be automatically adjusted (by Internal MCU). $VoutSet = ((Vout (mV) - 2800) * 10 / 99)$

17.2.9. Vrect ADC Reading (0x0040, 16-Bit)

Bit	Field Name	Mode	RW	Default Value	Description
15:0	VrectAdc	RX	R	-	Vrect uncompensated raw ADC reading. Scaled as 12-bit number for 25.2V full scale.

17.2.10. Iout Value Register (0x0044, 16-Bit)

Bit	Field Name	Mode	RW	Default Value	Description
15:0	IOut	RX	R	-	RX mode IOut value.

17.2.11. System Command Register (0x004E, 16-Bit)

Bit	Field Name	Mode	RW	Default Value	Description
15	Renegotiation	RX	W	0	AP sets 1 to generate renegotiation
14:10	Reserved	-	-	0	Reserved
9	Send WPC1P3 Data Packet	RX	W	0	AP sets 1 to generate WPC 1.3 data packet transfer
8	Soft Restart	RX	W	0	AP sets 1 to turn off and restart LDO Chip clears the bit after processing the command
7	Fast Charging	RX	W	0	AP sets 1 to switch the Voltage to fast charging Chip clears the bit after processing the command
6	Reserved	-	-	0	Reserved
5	Clear Interrupt	RX	W	0	AP sets 1 to send Clear Interrupt command Chip clears the bit after processing the command
4	Send Charge Status	RX	W	0	AP sets 1 to send Charge Status packet in RX mode Chip clears the bit after processing the command
3	Send End of Power	RX	W	0	AP sets 1 to send End of Power Transfer Packet in RX mode Chip clears the bit after processing the command
2	Send Device Authentication	RX	W	0	AP sets 1 to send Device Authentication Chip clears the bit after processing the command
1	Reserved	-	-	0	Reserved
0	Send PROP	RX	W	0	AP sets 1 to send proprietary packet Chip clears the bit after processing the command

Note: It costs time to implement the command. AP could write new command to System Command Register 3~5ms after the previous command.

17.2.12. Proprietary Data-Out Registers (0x0050 - 0x0057, 8 Bytes)

Address	Field Name	Mode	RW	Default Value	Description
0x0057	Prop Data 7	RX	RW	0x00	Byte 6 of Proprietary packet data
0x0056	Prop Data 6	RX	RW	0x00	Byte 5 of Proprietary packet data
0x0055	Prop Data 5	RX	RW	0x00	Byte 4 of Proprietary packet data
0x0054	Prop Data 4	RX	RW	0x00	Byte 3 of Proprietary packet data
0x0053	Prop Data 3	RX	RW	0x00	Byte 2 of Proprietary packet data
0x0052	Prop Data 2	RX	RW	0x00	Byte 1 of Proprietary packet data
0x0051	Prop Data 1	RX	RW	0x00	Byte 0 of Proprietary packet data
0x0050	Proprietary Header	RX	RW	0x00	Proprietary Packet Header. Allows up to 7 bytes to be included in the proprietary packet

17.2.13. Proprietary Data-In Registers (0x0058 - 0x005F, 8 Bytes)

Address	Field Name	Mode	RW	Default Value	Description
0x005F	Prop Data 7	RX	RW	0x00	Byte 6 of Proprietary packet data
0x005E	Prop Data 6	RX	RW	0x00	Byte 5 of Proprietary packet data
0x005D	Prop Data 5	RX	RW	0x00	Byte 4 of Proprietary packet data
0x005C	Prop Data 4	RX	RW	0x00	Byte 3 of Proprietary packet data
0x005B	Prop Data 3	RX	RW	0x00	Byte 2 of Proprietary packet data
0x005A	Prop Data 2	RX	RW	0x00	Byte 1 of Proprietary packet data
0x0059	Prop Data 1	RX	RW	0x00	Byte 0 of Proprietary packet data
0x0058	Proprietary Header	RX	RW	0x00	Proprietary Packet Header. Allows up to 7 bytes to be included in the Proprietary packet

17.2.14. ILIM Register (0x0060, 8-Bit)

Bit	Field Name	Mode	RW	Default Value	Description
7:0	ILim Set	RX	RW	0x09	Main LDO output current limit (by which LDO will behave as a constant current source) set value. $200 \text{ mA step ILim Set} = (\text{ILim Value (mA)} / 200) - 1$ Example: if ILIM value is 2A, then the ILIM Set would be 0x09

Note: This register is not recommended to do change. Alternatively, the

17.2.15. Over Voltage Register (0x0061, 8-Bit)

Bit	Field Name	Mode	RW	Default Value	Description
7:0	OV Clamp Voltage	RX	RW	0x04 (BPP) 0x01 (EPP)	0x00 = 18V 0x01 = 21V 0x02 = 16.7V 0x03 = 14.7V 0x04 = 13V 0x05 = 23.4V 0x06 = 24.7V 0x07 = 26V 0x08 = 27V 0x09 = 28V 0x0A = 29V 0x0B = 30V 0x0C = 31V 0x0D = 32V 0x0E = 33V 0x0F = 34.3V

Note: This register could be set only when chip works in non-autoOV mode. And this register should be used with extreme caution.

17.2.16. Reference Resonance Frequency Register (0x0065, 8-Bit)

Bit	Field Name	Mode	RW	Default Value	Description
7:0	Reference Resonance Frequency	RX	RW	0x76	Reference Resonance Frequency which is included in FOD/rf packet. A value of zero corresponds to a Reference Resonance Frequency in the range of 35.75kHz up to (but not including) 36.25kHz; and a value of 255 corresponds to a Reference Resonance Frequency in the range of 163.25 up to (but not including) 163.75kHz.

17.2.17. RX Mode Communication Modulation FET Register (0x0067, 8-Bit)

Bit	Field Name	Mode	RW	Default Value	Description
7:0	Com Mod Cap Settings	RX	RW	0x00	Modulation Channel Settings: (0b – Disable, 1b – Enable) BIT4: CMA BIT5: CMB BIT6: COM1 BIT7: COM2 Value – 0x00: Auto set Modulation Capacitors according to VOutset Value

17.2.18. FOD Registers (0x0068 - 0x0077, 16 Bytes)

The FOD registers are divided into eight pairs. Each pair has one byte for gain setting and one byte for offset setting. The first six pairs control the Received Power calculation for six power sectors during the Power Transfer phase. The seventh pair calibrates the internal DC Load. The set values of the FOD registers are found with the help of a Renesas developed calibration procedure using the nok9 tester.

The firmware initializes the FOD registers according to work mode (BPP/EPP). The correct set is loaded at completion of the ID and Configuration Phase. The AP can modify the registers at any time if needed to update the values.

Address and Bit	Field Name	Mode	RW	Default Value	Description
0x0077	Offset_7	RX	RW	0x48	FOD coefficients for Power Region 7: Offset Settings
0x0076	Gain_7	RX	RW	0x80	FOD coefficients for Power Region 7: Gain (slope settings)
0x0075	Offset_6	RX	RW	0x41	FOD coefficients for Power Region 6: Offset Settings
0x0074	Gain_6	RX	RW	0xA5	FOD coefficients for Power Region 6: Gain (slope settings)
0x0073	Offset_5	RX	RW	0x20	FOD coefficients for Power Region 5: Offset Settings
0x0072	Gain_5	RX	RW	0x93	FOD coefficients for Power Region 5: Gain (slope settings)
0x0071	Offset_4	RX	RW	0x45	FOD coefficients for Power Region 4: Offset Settings
0x0070	Gain_4	RX	RW	0x8F	FOD coefficients for Power Region 4: Gain (slope settings)
0x006F	Offset_3	RX	RW	0x54	FOD coefficients for Power Region 3: Offset Settings
0x006E	Gain_3	RX	RW	0x8F	FOD coefficients for Power Region 3: Gain (slope settings)
0x006D	Offset_2	RX	RW	0x48	FOD coefficients for Power Region 2: Offset Settings
0x006C	Gain_2	RX	RW	0x91	FOD coefficients for Power Region 2: Gain (slope settings)
0x006B	Offset_1	RX	RW	0x59	FOD coefficients for Power Region 1 = Offset Settings
0x006A	Gain_1	RX	RW	0x96	FOD coefficients for Power Region 1 = Gain (slope settings)
0x0069	Offset_0	RX	RW	0x59	FOD coefficients for Power Region 0 = Offset Settings
0x0068	Gain_0	RX	RW	0x96	FOD coefficients for Power Region 0 = Gain (slope settings)

17.2.19. Fast Charging Voltage Register (0x0078, 16-Bit)

Bit	Field Name	Mode	RW	Default Value	Description
15:0	Fast Charging Voltage	RX	RW	0x0000	Fast Charging Voltage in mV

17.2.20. Vout Value Register (0x0080, 16-Bit)

Bit	Field Name	Mode	RW	Default Value	Description
15:0	VOut	RX	R	-	Current VOut voltage value in mV in RX mode

17.2.21. Vrect Value Register (0x0082, 16-Bit)

Bit	Field Name	Mode	RW	Default Value	Description
15:0	Vrect	RX	R	-	Current Vrect Voltage value in mV

17.2.22. Die Temperature Value Register (0x0084, 16-Bit)

Bit	Field Name	Mode	RW	Default Value	Description
15:0	DIE Temperature in degrees Celsius	RX	R	-	Current Die Temperature value in degrees Celsius.

17.2.23. Operating Frequency Register (0x0086, 16-Bit)

Bit	Field Name	Mode	RW	Default Value	Description
15:0	Operating Frequency	RX	R	-	Current operating frequency of the AC signal frequency in kHz.

17.2.24. Digital Ping Frequency Register (0x0088, 16-Bit)

Bit	Field Name	Mode	RW	Default Value	Description
15:0	Ping Frequency	RX	R	-	Digital Ping Frequency of the AC signal (kHz) in RX mode

17.2.25. CEP Value Register (0x00A5, 8-Bit)

Bit	Field Name	Mode	RW	Default Value	Description
7:0	CEPValue	RX	R	-	8-bit signed number representing the last CEP value sent in Rx mode.

17.2.26. Tx Manufacturer Code Register (0x00B0, 16-Bit)

Bit	Field Name	Mode	RW	Default Value	Description
15:0	mpTxManufCode	RX	R	-	Tx Manufacturer code which is loaded from GETIDREQ packet in negotiation phase.

17.2.27. TX Guaranteed Power Register (0x00B3, 8-Bit)

Bit	Field Name	Mode	RW	Default Value	Description
15:0	Tx Guaranteed Power	RX	R	-	TX Guaranteed Power

17.2.28. TX WPC Revision ID Register (0x00B6, 8-Bit)

Bit	Field Name	Mode	RW	Default Value	Description
7:0	Tx Revision	RX	R	-	Tx WPC Revision ID

17.2.29. Re-Negotiation Status Register (0x00B7, 8-Bit)

Bit	Field Name	Mode	RW	Default Value	Description
7:3	Reserved	RX	R	0x00	Reserved
2	Renegotiation Error	RX	RW	0	Re-Negotiation phase is completed but error or NAK is met.
1	Renegotiation Done	RX	RW	0	Re-Negotiation phase is completed without error.
0	TX Capability Require	RX	RW	0	Request to send General Request Capabilities Packet during Re-Negotiation phase. This bit is self-cleared upon exit from the phase.

17.2.30. Current Guaranteed Power (0x00B9, 8-Bit)

Bit	Field Name	Mode	RW	Default Value	Description
7:0	MpCur.GP	RX	R	0x1E	Guaranteed Power Value in current power contract.

17.2.31. Request Guaranteed Power (0x00BD, 8-Bit)

Bit	Field Name	Mode	RW	Default Value	Description
7:0	mpReq.GP	RX	RW	0x1E	Requested Guaranteed Power Value. Units is 0.5W.

17.2.32. Q-FACTOR Register (0x00D2, 8-Bit)

Bit	Field Name	Mode	RW	Default Value	Description
7:0	Q Factor	RX	RW	0x53	Q-FACTOR value which is reported to TX in negotiation phase.

17.2.33. Signal Strength Packet Register (0x00D3, 8-Bit)

Bit	Field Name	Mode	RW	Default Value	Description
7:0	Signal Strength	RX	R	-	Signal Strength value.

17.2.34. Hvod Sink Current Register (0x00F9, 8-Bit)

Bit	Field Name	Mode	RW	Default Value	Description
7:0	HvodSinkCurrent	RX	RW	0x1f	PCLAMP Sink Current Value, only valid when PCLAMP OV mode is constant current mode and OV status is met. It is 7mA/step. The max value is 0x1f, which means 217mA.

17.2.35. Software Over Current Threshold Register (0x010C, 16-Bit)

Bit	Field Name	Mode	RW	Default Value	Description
15:0	Software OCP Threshold	RX	RW	0x0DAC	Software OCP threshold. When current exceeds this threshold, interrupt [Over Current Fault] is sent to AP.

17.2.36. Software Over Current Threshold Hysteresis Register (0x010E, 8-Bit)

Bit	Field Name	Mode	RW	Default Value	Description
7:0	Software OCP Threshold Hysteresis	RX	RW	0xC8	Software OCP threshold hysteresis. When current exceeds (Software OCP Threshold + Software OCP Threshold Hysteresis), interrupt [Over Current Fault] is sent to AP, and EPT[OCP] is sent to Tx.

17.2.37. Vrect Knee Register (0x0142, 8-Bit)

Bit	Field Name	Mode	RW	Default Value	Description
7:0	PwrKnee	RX	RW	25 (BPP) 50 (EPP)	Threshold in units of 0.1W output power at which minimal window is applied.

17.2.38. Vrect Correction Factor Register (0x0143, 8-Bit)

Bit	Field Name	Mode	RW	Default Value	Description
7:0	VrCorrFactor	RX	RW	12 (BPP) 4 (EPP)	Coefficient value which is used in the Vrect Target calculation algorithm.

17.2.39. Vrect Maximum Correction Register (0x0144, 16-Bit)

Bit	Field Name	Mode	RW	Default Value	Description
15:0	VrMaxCorr	RX	RW	195 (BPP) 195 (EPP)	Maximum value of the header room in ADC codes.

17.2.40. Vrect Minimum Correction Register (0x0146, 16-Bit)

Bit	Field Name	Mode	RW	Default Value	Description
15:0	VrMinCorr	RX	RW	0 (BPP) 0 (EPP)	Minimum value of the header room in ADC codes.

17.2.41. FOD Section Register (0x0149, 8-Bit)

Bit	Field Name	Mode	RW	Default Value	Description
15:0	Fod Section	RX	R	0x00	Contains the index of the FOD section used during the last RPP value calculation. Used for debug only.

17.2.42. Vrect Adjust Register (0x014E, 8-Bit)

Bit	Field Name	Mode	RW	Default Value	Description
7:0	VRect Adjust	RX	R	0x00	8-bit signed integer representing Vrect final adjustment in ADC codes. The adjustment is applied during the final step of the VrectTarget calculation, thus overwriting Minimum and Maximum boundaries

18. TX Mode Register

18.1 System Interrupt Clear Register in TX Mode (0x0028 - 0x002B, 32-Bit)

Bit	Field Name	Mode	RW	Default Value	Description
31:19	Reserved	-	-	-	Reserved
18	Adaptor Detection Done	TX	RW	0	AP writes 1 to clear the corresponding Interrupt Registers' bit and this bit is self-cleared to 0 (by M0) afterwards.
17	ID Authentication Pass	TX	RW	0	AP writes 1 to clear the corresponding Interrupt Registers' bit and this bit is self-cleared to 0 (by M0) afterwards.
16	ID Authentication packet Received	TX	RW	0	AP writes 1 to clear the corresponding Interrupt Registers' bit and this bit is self-cleared to 0 (by M0) afterwards.
15	CSP Packet Received	TX	RW	0	AP writes 1 to clear the corresponding Interrupt Registers' bit and this bit is self-cleared to 0 (by M0) afterwards.
14	EPT Restart Received	TX	RW	0	AP writes 1 to clear the corresponding Interrupt Registers' bit and this bit is self-cleared to 0 (by M0) afterwards.
13	Proprietary Packet Received	TX	RW	0	AP writes 1 to clear the corresponding Interrupt Registers' bit and this bit is self-cleared to 0 (by M0) afterwards.
12:9	Reserved	-	-	-	Reserved
8	BLE Address Received	TX	RW	0	AP writes 1 to clear the corresponding Interrupt Registers' bit and this bit is self-cleared to 0 (by M0) afterwards.
7	TX Initialization Done	TX	RW	0	AP writes 1 to clear the corresponding Interrupt Registers' bit and this bit is self-cleared to 0 (by M0) afterwards.
6	TX Conflict	TX	RW	0	AP writes 1 to clear the corresponding Interrupt Registers' bit and this bit is self-cleared to 0 (by M0) afterwards.
5	Operation Mode Change	TX	RW	0	AP writes 1 to clear the corresponding Interrupt Registers' bit and this bit is self-cleared to 0 (by M0) afterwards.
4	Configuration Packet Received	TX	RW	0	AP writes 1 to clear the corresponding Interrupt Registers' bit and this bit is self-cleared to 0 (by M0) afterwards.
3	Identification Packet Received	TX	RW	0	AP writes 1 to clear the corresponding Interrupt Registers' bit and this bit is self-cleared to 0 (by M0) afterwards.
2	Signal Strength Packet Received	TX	RW	0	AP writes 1 to clear the corresponding Interrupt Registers' bit and this bit is self-cleared to 0 (by M0) afterwards.
1	Start Digital Ping	TX	RW	0	AP writes 1 to clear the corresponding Interrupt Registers' bit and this bit is self-cleared to 0 (by M0) afterwards.
0	EPT Type	TX	RW	0	AP writes 1 to clear the corresponding Interrupt Registers' bit and this bit is self-cleared to 0 (by M0) afterwards.

18.2 System Status Register in TX Mode (0x002C - 0x002F, 32-Bit)

Bit	Field Name	Mode	RW	Default Value	Description
31:19	Reserved	-	-	-	Reserved
18	Adaptor Detection Done	TX	R	-	1 = Adaptor detection is done. Extra circuit is necessary for this function.
17	ID Authentication Pass	TX	R	-	1 = ID authentication is passed.
16	ID Authentication packet Received	TX	R	-	1 = ID authentication packet is received.
15	CSP Packet Received	TX	R	-	1 = CSP packet is received. Cleared together with the corresponding interrupt flag
14	EPT Restart Received	TX	R	-	1 = EPT is received, Restart communication
13	Proprietary Packet Received	TX	R	-	1 = Proprietary packet is received
12:9	Reserved	-	-	-	Reserved
8	BLE Address Received	TX	R	-	1 = BLE address is received.
7	TX Initialization Done	TX	R	-	1 = TX Initialization is successful
6	TX Conflict	TX	R	-	1 = Chip works in Tx mode but is put on another Tx device.
5	Operation Mode Change	TX	R	-	1 = Operating mode is changed
4	Configuration Packet Received	TX	R	-	1 = Configuration packet is received
3	Identification Packet Received	TX	R	-	1 = Identification packet is received
2	Signal Strength Packet Received	TX	R	-	1 = Signal Strength packet is received
1	Start Digital Ping	TX	R	-	1 = Digital Ping started
0	EPT Type	TX	R	-	1 = Error is met and recommend AP to remove power in this case. AP could read the error type from TRx End Power Transfer Reason Register

18.3 System Interrupt Register in TX Mode (0x0030 - 0x0033, 32-Bit)

Bit	Field Name	Mode	RW	Default Value	Description
31:19	Reserved	-	-	-	Reserved
18	Adaptor Detection Done	TX	R	0	1 = Adaptor detection is done. Extra circuit is necessary for this function. 0 = No such condition exists
17	ID Authentication Pass	TX	R	0	1 = ID authentication is passed. 0 = No such condition exists
16	ID Authentication packet Received	TX	R	0	1 = ID authentication packet is received. 0 = No such condition exists
15	CSP Packet Received	TX	R	0	1 = CSP packet is received. Cleared together with the corresponding interrupt flag 0 = No such condition exists
14	EPT Restart Received	TX	R	0	1 = EPT is received, Restart communication 0 = No such condition exists
13	Proprietary Packet Received	TX	R	0	1 = Proprietary packet is received 0 = No such condition exists
12:9	Reserved	-	-	-	Reserved
8	BLE Address Received	TX	R	0	1 = BLE address is received. 0 = No such condition exists
7	TX Initialization Done	TX	R	0	1 = TX Initialization is successful 0 = No such condition exists
6	TX Conflict	TX	R	0	1 = Chip works in Tx mode, but is put on another Tx device 0 = No such condition exists
5	Operation Mode Change	TX	R	0	1 = Operating mode is changed 0 = No such condition exists
4	Configuration Packet Received	TX	R	0	1 = Configuration packet is received 0 = No such condition exists
3	Identification Packet Received	TX	R	0	1 = Identification packet is received 0 = No such condition exists
2	Signal Strength Packet Received	TX	R	0	1 = Signal Strength packet is received 0 = No such condition exists
1	Start Digital Ping	TX	R	0	1 = Digital Ping started 0 = No such condition exists
0	EPT Type	TX	R	0	1 = Error is met and recommend AP to remove power in this case. AP could read the error type from TRx End Power Transfer Reason Register 0 = No such condition exists

18.4 System Interrupt Enable Register in TX Mode (0x0034 - 0x0037, 32-Bit)

Bit	Field Name	Mode	RW	Default Value	Description
31:19	Reserved	-	-	-	Reserved
18	Adaptor Detection Done	TX	RW	1	1 = Corresponding interrupt is enabled 0 = Corresponding interrupt is disabled
17	ID Authentication Pass	TX	RW	1	1 = Corresponding interrupt is enabled 0 = Corresponding interrupt is disabled
16	ID Authentication packet Received	TX	RW	1	1 = Corresponding interrupt is enabled 0 = Corresponding interrupt is disabled
15	CSP Packet Received	TX	RW	1	1 = Corresponding interrupt is enabled 0 = Corresponding interrupt is disabled
14	EPT Restart Received	TX	RW	1	1 = Corresponding interrupt is enabled 0 = Corresponding interrupt is disabled
13	Proprietary Packet Received	TX	RW	1	1 = Corresponding interrupt is enabled 0 = Corresponding interrupt is disabled
12:9	Reserved	-	-	-	Reserved
8	BLE Address Received	TX	RW	1	1 = Corresponding interrupt is enabled 0 = Corresponding interrupt is disabled
7	TX Initialization Done	TX	RW	1	1 = Corresponding interrupt is enabled 0 = Corresponding interrupt is disabled
6	TX Conflict	TX	RW	1	1 = Corresponding interrupt is enabled 0 = Corresponding interrupt is disabled
5	Operation Mode Change	TX	RW	1	1 = Corresponding interrupt is enabled 0 = Corresponding interrupt is disabled
4	Configuration Packet Received	TX	RW	1	1 = Corresponding interrupt is enabled 0 = Corresponding interrupt is disabled
3	Identification Packet Received	TX	RW	1	1 = Corresponding interrupt is enabled 0 = Corresponding interrupt is disabled
2	Signal Strength Packet Received	TX	RW	1	1 = Corresponding interrupt is enabled 0 = Corresponding interrupt is disabled
1	Start Digital Ping	TX	RW	1	1 = Corresponding interrupt is enabled 0 = Corresponding interrupt is disabled
0	EPT Type	TX	RW	1	1 = Corresponding interrupt is enabled 0 = Corresponding interrupt is disabled

18.5 Battery Charge Status Register (0x003A, 8-Bit)

Bit	Field Name	Mode	RW	Default Value	Description
7:0	Charge Status	TX	R	0x00	In TX mode, it is the value in Charge Status Packet which is sent by Rx.

18.6 End of Power Transfer Register in TX Mode (0x003B, 8-Bit)

Bit	Field Name	Mode	RW	Default Value	Description
7:0	EPT/EOC/EOP Reason	TX	R	0x00	The EPT reason which is read from previous EPT packet from Rx. A WPC End of Power Transfer packet/message will be sent with the following definition: 0 = WPC mode, unknown 1 = WPC mode, Charge Complete 2 = WPC mode, Internal Fault 3 = WPC mode, Over Temperature 4 = WPC mode, Over Voltage 5 = WPC mode, Over Current 6 = WPC mode, Battery Failure 7 = WPC mode, Re-Configuration 8 = WPC mode, No Response 10 = WPC mode, Negotiation Failure 11 = WPC mode, Restart Power All other values are reserved.

18.7 Iin Value Register (0x0044, 16-Bit)

Bit	Field Name	Mode	RW	Default Value	Description
15:0	Iin	TX	R	-	Iin in TX Mode, value in mA.

18.8 Proprietary Data-Out Registers (0x0050 - 0x0057, 8 Bytes)

Address	Field Name	Mode	RW	Default Value	Description
0x0057	Prop Data 7	TX	RW	0x00	Byte 6 of Proprietary packet data
0x0056	Prop Data 6	TX	RW	0x00	Byte 5 of Proprietary packet data
0x0055	Prop Data 5	TX	RW	0x00	Byte 4 of Proprietary packet data
0x0054	Prop Data 4	TX	RW	0x00	Byte 3 of Proprietary packet data
0x0053	Prop Data 3	TX	RW	0x00	Byte 2 of Proprietary packet data
0x0052	Prop Data 2	TX	RW	0x00	Byte 1 of Proprietary packet data
0x0051	Prop Data 1	TX	RW	0x00	Byte 0 of Proprietary packet data

Address	Field Name	Mode	RW	Default Value	Description
0x0050	Proprietary Header	TX	RW	0x00	Proprietary Packet Header. Allows up to 7 bytes to be included in the proprietary packet

18.9 Proprietary Data-In Registers (0x0058 - 0x005F, 8 Bytes)

Address	Field Name	Mode	RW	Default Value	Description
0x005F	Prop Data 7	TX	RW	0x00	Byte 6 of Proprietary packet data
0x005E	Prop Data 6	TX	RW	0x00	Byte 5 of Proprietary packet data
0x005D	Prop Data 5	TX	RW	0x00	Byte 4 of Proprietary packet data
0x005C	Prop Data 4	TX	RW	0x00	Byte 3 of Proprietary packet data
0x005B	Prop Data 3	TX	RW	0x00	Byte 2 of Proprietary packet data
0x005A	Prop Data 2	TX	RW	0x00	Byte 1 of Proprietary packet data
0x0059	Prop Data 1	TX	RW	0x00	Byte 0 of Proprietary packet data
0x0058	Proprietary Header	TX	RW	0x00	Proprietary Packet Header. Allows up to 7 bytes to be included in the Proprietary packet

18.10 Tx EPT Type Register (0x007A, 16-Bit)

Bit	Field Name	Mode	RW	Default Value	Description
15	EPT POCP	TX	R	0	1 = indicates current protect during digital ping 0 = No such Error
14	EPT OTP	TX	R	0	1 = indicates Over Temperature Error 0 = No such Error
13	EPT FOD	TX	R	0	1 = indicates FOD 0 = No such Error
12	EPT LVP	TX	R	0	1 = indicates Low Voltage Error 0 = No such Error
11	EPT OVP	TX	R	0	1 = indicates Over Voltage Error 0 = No such Error
10	EPT OCP	TX	R	0	1 = indicates Over Current Error 0 = No such Error
9	EPT RPP TIMEOUT	TX	R	0	1 = indicates RPP Timeout Error 0 = No such Error
8	EPT CEP TIMEOUT	TX	R	0	1 = indicates CEP Timeout Error 0 = No such Error

Bit	Field Name	Mode	RW	Default Value	Description
7	EPT TIMEOUT	TX	R	0	1 = indicates Watch-Dog Timeout Error 0 = No such Error
6	EPT NOI2CDATA TIMEOUT	TX	R	0	1 = indicates Nol2C data Timeout Error 0 = No such Error
5	EPT TX CONFLICT	TX	R	0	1 = indicates Tx Conflict Error 0 = No such Error
4	EPT PING VOLTAGE	TX	R	0	1 = indicates the ping voltage exceeds the correct range. Only valid in VPWM mode 0 = No such Error
3	EPT AUTHENTICATION FAIL	TX	R	0	1 = indicates the authentication is failed and power is removed. Only valid when authentication is required. 0 = No such Error
2:1	Reserved	-	-	-	Reserved
0	EPT CMD	TX	R	0	1 = indicates EPT Command from WPC RX 0 = No such Error

18.11 TX System Command Register (0x007C, 16-Bit)

Bit	Field Name	Mode	RW	Default Value	Description
15	TX TGL OPEN LOOP	TX	RW	0	AP sets 1 to toggle open loop mode. Chip clears the bit after processing
14	TX OPEN LOOP SYNC	TX	RW	0	AP sets 1 to synchronize open loop parameters one time. Chip clears the bit after processing
13:5	Reserved	-	-	-	Reserved
4	TX WD	TX	RW	0	AP sets 1 to enable Watch Dog in TX mode. Chip clears the bit after processing
3	TX BC	TX	RW	0	AP sets 1 to send proprietary packet to RX. Chip clears the bit after processing
2	TX DIS	TX	RW	0	AP sets 1 to disable Tx function. Chip clears the bit after processing
1	CLR Interrupt	TX	RW	0	AP sets 1 to clear interrupts. Chip clears the bit after processing
0	TX EN	TX	RW	0	AP sets 1 to start digital ping. Chip clears the bit after processing

18.12 TX Status Register (0x007E, 8-Bit)

Bit	Field Name	Mode	RW	Default Value	Description
7:4	Reserved	-	-	-	Reserved
3	TX transfer	TX	RW	0	Chip works in power transfer phase
2	Reserved	-	-	-	Reserved
1	TX ready	TX	RW	0	Chip is ready and wait for TX_EN command
0	TX Digital Ping	TX	RW	0	Chip works in digital ping phase

18.13 Vin Value Register (0x0080, 16-Bit)

Bit	Field Name	Mode	RW	Default Value	Description
15:0	Vin	TX	R	-	Current Vin voltage in TX mode, value in mV

18.14 Vrect Value Register (0x0082, 16-Bit)

Bit	Field Name	Mode	RW	Default Value	Description
15:0	Vrect	TX	R	-	Current Vrect voltage value in Tx mode, value in mV

18.15 Die Temperature Value Register (0x0084, 16-Bit)

Bit	Field Name	Mode	RW	Default Value	Description
15:0	Die Temperature in degrees Celsius	TX	R	-	Current Die Temperature value in degrees Celsius.

18.16 CEP Value Register (0x00A5, 8-Bit)

Bit	Field Name	Mode	RW	Default Value	Description
7:0	CEP Value	TX	R	0x00	8-bit signed number in last received CEP.

18.17 Rx Manufacturer Code Register (0x00B0, 16- Bit)

Bit	Field Name	Mode	RW	Default Value	Description
15:0	RxManufCode	TX	R	-	The WPC Manufacturer code of the pairing device.

18.18 Signal Strength Packet Register (0x00D3, 8-Bit)

Bit	Field Name	Mode	RW	Default Value	Description
7:0	Signal Strength	TX	R	-	Signal Strength value which is received at the beginning of power transfer

18.19 Ping Interval Register (0x00E0, 16-Bit)

Bit	Field Name	Mode	RW	Default Value	Description
15:0	Ping Interval	TX	RW	0x04B0	The interval between each digital ping, value in ms.

18.20 Ping Frequency Register (0x00E2, 16-Bit)

Bit	Field Name	Mode	RW	Default Value	Description
15:0	Ping Frequency	TX	RW	0x015F	Frequency = 60 MHz / N.

18.21 Ping Duty Setting Register (0x00E4, 8-Bit)

Bit	Field Name	Mode	RW	Default Value	Description
7:0	Ping Duty Setting	TX	RW	0x4C	Duty cycle at the beginning of digital ping.

18.22 Low Voltage Threshold Register (0x00EC, 16-Bit)

Bit	Field Name	Mode	RW	Default Value	Description
15:0	LVP	TX	RW	0x1194	Threshold for Low Voltage Protection in mV

18.23 Over Voltage Threshold Register (0x00E8, 16-Bit)

Bit	Field Name	Mode	RW	Default Value	Description
15:0	OVpThd	TX	RW	0x2AF8	Over Voltage Threshold in TX mode, value in mV

18.24 FOD Low Segment Threshold Register (0x00F8, 16-Bit)

Bit	Field Name	Mode	RW	Default Value	Description
15:0	FodThdL	TX	RW	0x005A	FOD threshold for low level segment in Tx mode, value in mW, signed number.

18.25 FOD High Segment Threshold Register (0x00FA, 16-Bit)

Bit	Field Name	Mode	RW	Default Value	Description
15:0	FodThdH	TX	RW	0x005A	FOD threshold for high level segment in Tx mode, value in mW, signed number, The value of 0xff9c means – 100mW.

18.26 FOD Segment Threshold Register (0x00FC, 16-Bit)

Bit	Field Name	Mode	RW	Default Value	Description
15:0	FodSegThd	TX	RW	0x0802	Threshold for two segment FOD threshold. Value in mW. If Rx Power is higher than FOD Segment Threshold, the High Level FOD Threshold is used, otherwise, the Low Level FOD Threshold is used as FOD threshold.

18.27 Over Current Threshold Register (0x0108, 16-Bit)

Bit	Field Name	Mode	RW	Default Value	Description
15:0	OCpThd	TX	RW	0x09C4	Over Current Threshold in TX mode, value in mA

18.28 Minimum Operating Frequency in FB Register (0x0114, 16-Bit)

Bit	Field Name	Mode	RW	Default Value	Description
15:0	Minimum Operating Frequency in Full Bridge mode	TX	RW	0x0208	Minimum operating frequency (AC signal frequency on the coil) in Full Bridge. Frequency = 60 MHz / N, Default is 0x209 (115KHz)

18.29 Minimum Operating Frequency in HB Register (0x0116, 16-Bit)

Bit	Field Name	Mode	RW	Default Value	Description
15:0	Minimum Operating Frequency in Half Bridge mode	TX	RW	0x01F3	Minimum operating frequency (AC signal frequency on the coil) in Half Bridge. Frequency = 60 MHz / N Default is 0x1F3 (120 KHz)

18.30 Maximum Operating Frequency Register (0x0118 16-Bit)

Bit	Field Name	Mode	RW	Default Value	Description
15:0	Maximum Operating Frequency	TX	RW	0x019C	Maximum operating frequency (AC signal frequency on the coil) in TX mode. Frequency = 60 MHz / N Default is 0x19C (145 KHz).

18.31 Minimum Duty Register (0x011A, 8-Bit)

Bit	Field Name	Mode	RW	Default Value	Description
7:0	Minimum Duty	TX	RW	0x28	Minimum duty cycle when the operating frequency has reached the maximum value. Duty = N / (256 *2) Default is 0x29(8%).

18.32 TX DC Power Register (0x0156, 16-Bit)

Bit	Field Name	Mode	RW	Default Value	Description
15:0	TX DC Power	TX	R	-	Input power which is used in power loss FOD detection.

18.33 Operating Frequency Register (0x0182, 16-Bit)

Bit	Field Name	Mode	RW	Default Value	Description
15:0	Operation Frequency	TX	R	-	Operating Frequency (AC signal frequency on the coil). Operation Frequency = 60MHz / N.

18.34 Operating Duty-Cycle Register (0x018C, 8-Bit)

Bit	Field Name	Mode	RW	Default Value	Description
7:0	TX Operating Duty Cycle	TX	R	-	TX duty cycle when the operating frequency has reached the maximum value. Duty = $N / (256 * 2)$ For example: 0x19(5%) ~ 0xFF(50%)

18.35 BLE MAC Address Registers (0x01B4 - 0x01B9, 6 Bytes)

Address	Field Name	Mode	RW	Default Value	Description
0x01B9	BLE MAC Address [5]	TX	RW	0x00	Byte 5 of BLE MAC address
0x01B8	BLE MAC Address [4]	TX	RW	0x00	Byte 4 of BLE MAC address
0x01B7	BLE MAC Address [3]	TX	RW	0x00	Byte 3 of BLE MAC address
0x01B6	BLE MAC Address [2]	TX	RW	0x00	Byte 2 of BLE MAC address
0x01B5	BLE MAC Address [1]	TX	RW	0x00	Byte 1 of BLE MAC address
0x01B4	BLE MAC Address [0]	TX	RW	0x00	Byte 0 of BLE MAC address

19. Ordering Information

Part Number	Description
RTKA9530A0D00000BU	RA9530-R Evaluation Kit

20. Revision History

Revision	Date	Description
2.00	Jul 22, 2022	Updated sample signal waveforms Completed minor changes throughout
1.00	Jun 2, 2022	Initial release.

IMPORTANT NOTICE AND DISCLAIMER

RENESAS ELECTRONICS CORPORATION AND ITS SUBSIDIARIES (“RENESAS”) PROVIDES TECHNICAL SPECIFICATIONS AND RELIABILITY DATA (INCLUDING DATASHEETS), DESIGN RESOURCES (INCLUDING REFERENCE DESIGNS), APPLICATION OR OTHER DESIGN ADVICE, WEB TOOLS, SAFETY INFORMATION, AND OTHER RESOURCES “AS IS” AND WITH ALL FAULTS, AND DISCLAIMS ALL WARRANTIES, EXPRESS OR IMPLIED, INCLUDING, WITHOUT LIMITATION, ANY IMPLIED WARRANTIES OF MERCHANTABILITY, FITNESS FOR A PARTICULAR PURPOSE, OR NON-INFRINGEMENT OF THIRD-PARTY INTELLECTUAL PROPERTY RIGHTS.

These resources are intended for developers who are designing with Renesas products. You are solely responsible for (1) selecting the appropriate products for your application, (2) designing, validating, and testing your application, and (3) ensuring your application meets applicable standards, and any other safety, security, or other requirements. These resources are subject to change without notice. Renesas grants you permission to use these resources only to develop an application that uses Renesas products. Other reproduction or use of these resources is strictly prohibited. No license is granted to any other Renesas intellectual property or to any third-party intellectual property. Renesas disclaims responsibility for, and you will fully indemnify Renesas and its representatives against, any claims, damages, costs, losses, or liabilities arising from your use of these resources. Renesas' products are provided only subject to Renesas' Terms and Conditions of Sale or other applicable terms agreed to in writing. No use of any Renesas resources expands or otherwise alters any applicable warranties or warranty disclaimers for these products.

(Disclaimer Rev.1.01 Jan 2024)

Corporate Headquarters

TOYOSU FORESIA, 3-2-24 Toyosu,
Koto-ku, Tokyo 135-0061, Japan
www.renesas.com

Trademarks

Renesas and the Renesas logo are trademarks of Renesas Electronics Corporation. All trademarks and registered trademarks are the property of their respective owners.

Contact Information

For further information on a product, technology, the most up-to-date version of a document, or your nearest sales office, please visit www.renesas.com/contact-us/.