

US082-ZSSC3123EVZ

Pmod™ Board

Description

The US082-ZSSC3123EVZ Pmod board demonstrates the functionality and performance of the [ZSSC3123](#). The ZSSC3123 is a CMOS integrated circuit for accurate capacitance-to-digital conversion and sensor-specific correction of capacitive sensor signals. Digital compensation of sensor offset, sensitivity, and temperature drift is accomplished using an internal digital signal processor running a correction algorithm with calibration coefficients stored in a non-volatile EEPROM.

The ZSSC3123 is configurable for capacitive sensors with capacitances up to 260pF and a sensitivity of 125aF/LSB to 1pF/LSB depending on resolution, speed, and range settings. It is compatible with both single-capacitive sensors (both terminals must be accessible) and differential-capacitive sensors. Measured and corrected sensor values can be output as I²C, SPI, pulse density modulation (PDM), or alarms.

Kit Contents

- US082-ZSSC3123EVZ Pmod Board
- Die or 4.4 x 5.0 mm 14-TSSOP package

Features

- Maximum target input capacitance: 260pF
- Sampling rates as fast as 0.7ms at 8-bit resolution; 1.6ms at 10-bit; 5.0ms at 12-bit; 18.5ms at 14-bit
- Digital compensation of sensor: piece-wise 1st and 2nd order sensor compensation or up to 3rd order single-region sensor compensation
- Digital compensation of 1st and 2nd order temperature gain and offset drift
- Internal temperature compensation reference (no external components)
- Programmable capacitance span and offset
- Layout customized for die-die bonding with sensor for low cost, high-density chip-on-board assembly
- Accuracy as high as ±0.25% FSO at -40°C to 125°C, 3V, 5V, V_{SUPPLY} ±10% (for restrictions, see section 5 of the [ZSSC3123 Datasheet](#))
- Wide capacitance range to support a broad portfolio of different sensor elements
- Excellent for low-power battery applications
- I²C or SPI interface – easy connection to a microcontroller
- PDM outputs (Filtered Analog Ratiometric) for both capacitance and temperature
- Up to two alarms that can act as full push-pull or open-drain switches
- Supply voltage: 2.3V to 5.5V
- Typical current consumption 750µA down to 60µA depending on configuration
- Typical Sleep Mode current: ≤ 1µA at 85°C
- Operation temperature: -40°C to +125°C

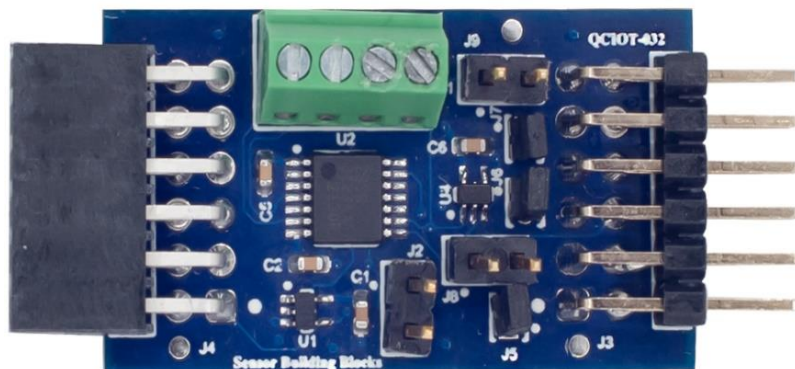

Figure 1. US082-ZSSC3123EVZ Pmod Board

Contents

1. Functional Description	3
1.1 Setup and Configuration.....	3
1.1.1 Software Installation.....	3
1.1.2 Kit Hardware Connections	4
2. Board Design	5
2.1 Schematic Diagrams.....	6
2.2 Bill of Materials (BOM).....	7
2.3 Board Layout	8
3. Software Design	9
3.1 Project Code Structure	9
3.2 ZSSC3123 API	10
4. Board Test	11
4.1 Run Code in Debug Mode	11
4.2 Check Sensor Output	13
5. Ordering Information	13
6. Revision History	13

Figures

Figure 1. US082-ZSSC3123EVZ Pmod Board.....	1
Figure 2. US082-ZSSC3123EVZ (Wide Capacitance) Pmod Board Block Diagram	3
Figure 3. US082-ZSSC3123EVZ Pmod Board with EK-RA2E1 MCU Kit.....	4
Figure 4. US082-ZSSC3123EVZ Pmod Board Image (Top).....	5
Figure 5. US082-ZSSC3123EVZ Pmod Board Image (Bottom).....	5
Figure 6. US082-ZSSC3123EVZ Pmod Board Schematic.....	6
Figure 7. Top Overlay	8
Figure 8. Top Layer	8
Figure 9. Layer 2 (GND)	8
Figure 10. Layer 3 (Signal)	8
Figure 11. Bottom Layer	8
Figure 12. Bottom Overlay	8
Figure 13. Project Structure.....	9
Figure 14. FSP Stacks.....	10
Figure 15. Debug Configuration.....	11
Figure 16. Start Debug Mode	11
Figure 17. Code Debug Mode	12
Figure 18. Sensor Reading.....	13

1. Functional Description

The US082-ZSSC3123EVZ Pmod board is intended as a quick connect prototyping solution for ZSSC3123. Figure 2 highlights the main parts of the system.

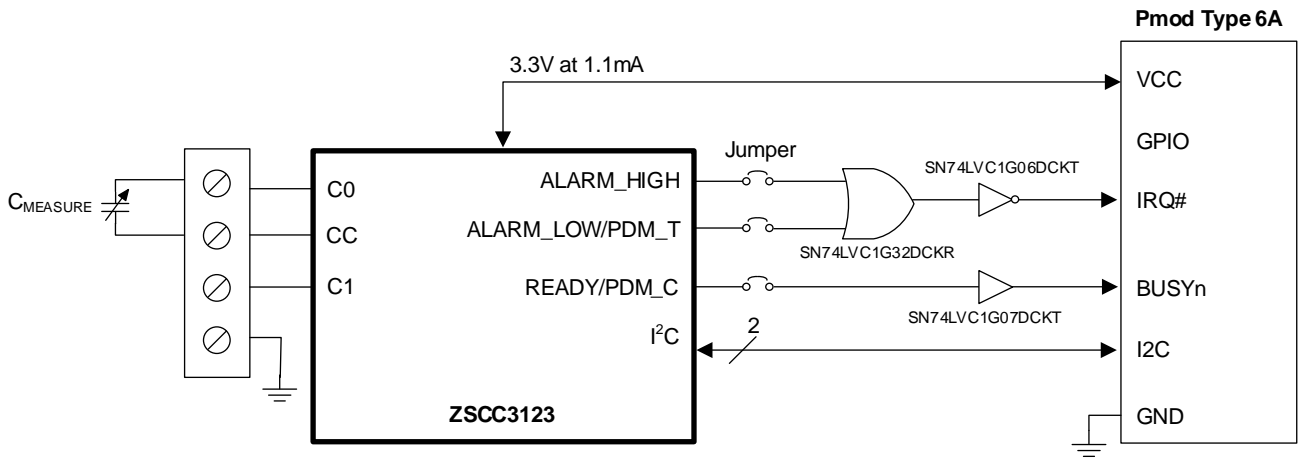

Figure 2. US082-ZSSC3123EVZ (Wide Capacitance) Pmod Board Block Diagram

1.1 Setup and Configuration

Required or recommended user equipment:

- Renesas Evaluation Board: [EK-RA2E1](#)
- USB micro-B cable (provided with EK board)
- PC running Windows® 10/11 with at least two USB ports
- [US082-INTERPEVZ](#) board
- Capacitive sensor and 130pF to 260pF through hole capacitor for quick evaluation

Required or recommended software:

- Renesas Flexible Software Package v5.4.0 platform installation:
 - Renesas [e² studio](#) 2024-04 or later
 - FSP 5.4.0 or later
 - GCC Arm Embedded 13.2.1 (13.2.1.arm-13-7) or later
- Sample code files (available on the [ZSSC3123](#) product page)

The US082-ZSSC3123EVZ Pmod Board should be calibrated before running this demonstration. The calibration software and documentation are available on the [ZSSC3123](#) product page.

1.1.1 Software Installation

For the latest version of the installer software, visit the [e² studio](#) product page.

1.1.2 Kit Hardware Connections

To set up the kit, complete the following procedures (see also Figure 3).

1. Ensure that the MCU development kit supports a Type 6A Pmod connector.
 - a. For the EK-RA2E1 board, a Pmod1 connector is available.
2. On the US082-ZSSC3123EVZ board, populate J5, J6, and J7 with jumpers and leave the other jumpers open.
3. Plug in the US082-INTERPEVZ board to Pmod1 connector of the EK-RA2E1 board. Be careful to align Pin 1 on the Pmod board and MCU kit.
4. Plug in the US082-ZSSC3123EVZ board to the US082-INTERPEVZ board.
5. Connect the capacitive sensor or 130pF to 260pf through hole capacitor to connector pins 1 and 2 of J1 on the US082-ZSSC3123EVZ board.
6. Connect the EK-RA2E1 board with a computer using a USB micro-B cable.
7. The device is now ready to be used in the system.

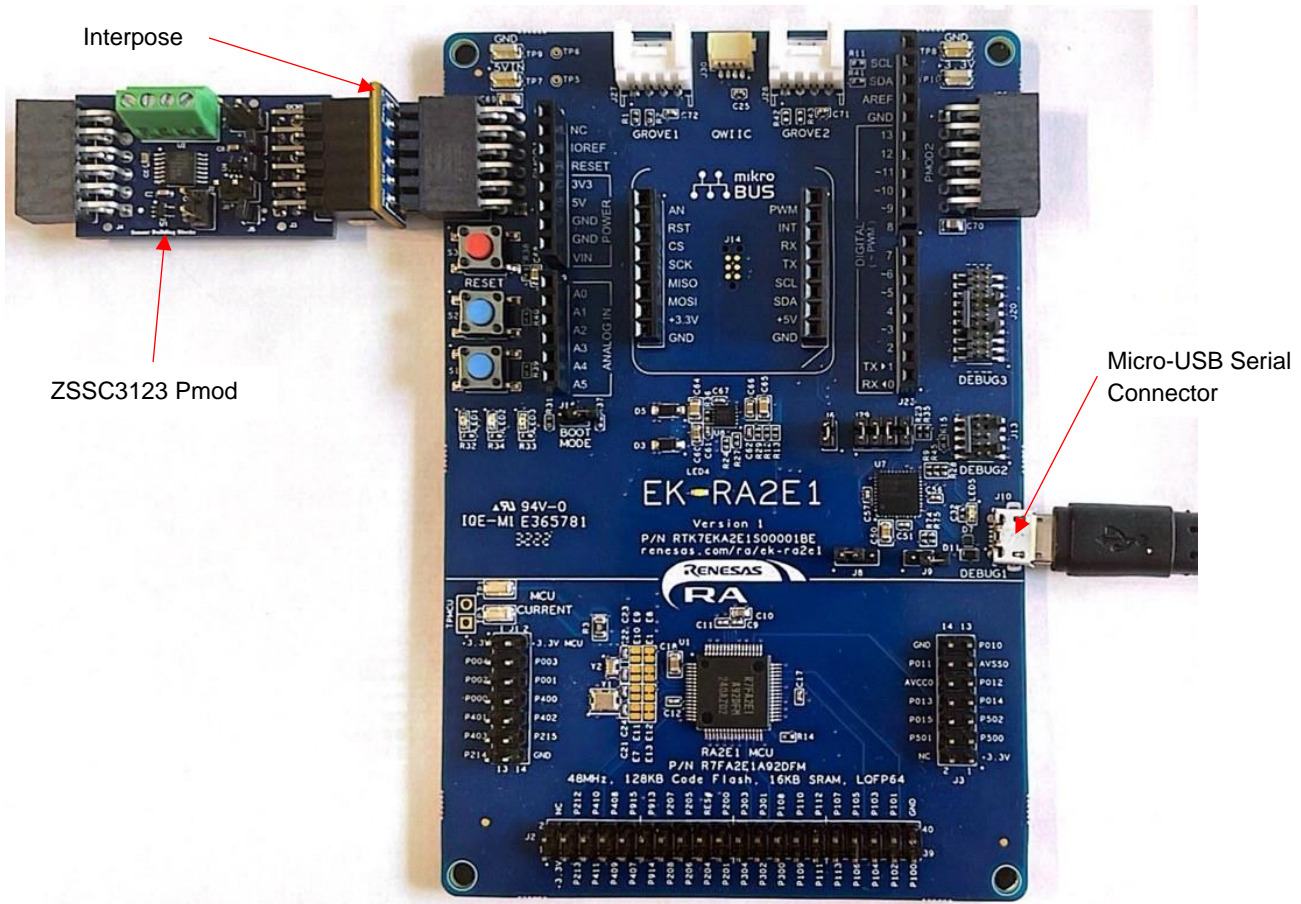

Figure 3. US082-ZSSC3123EVZ Pmod Board with EK-RA2E1 MCU Kit

2. Board Design

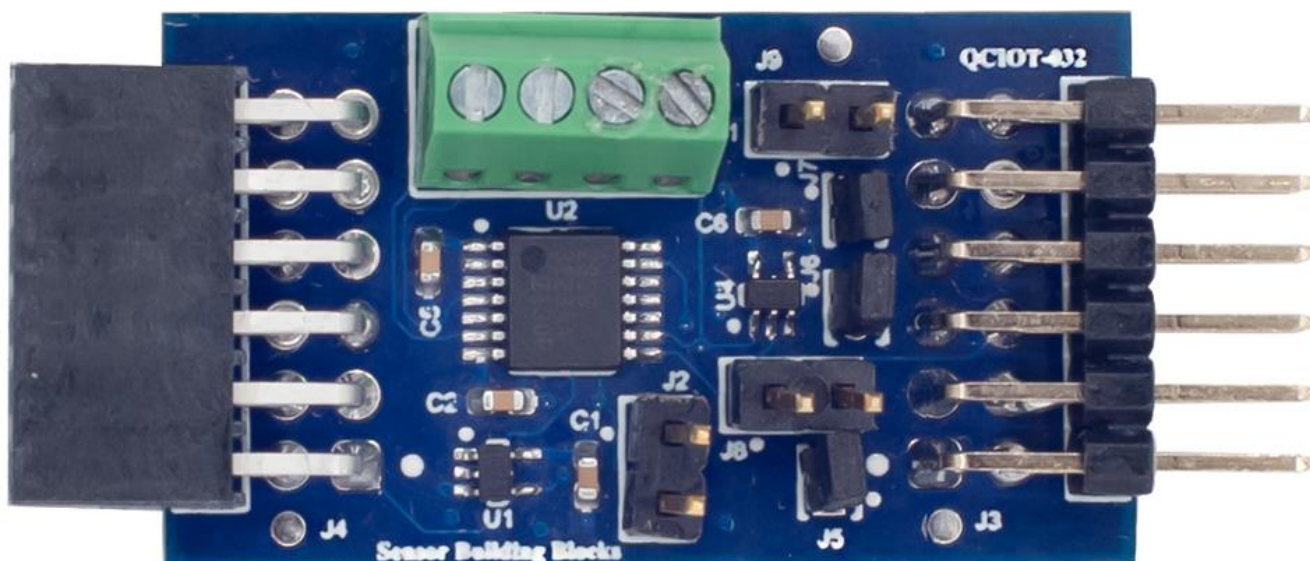

Figure 4. US082-ZSSC3123EVZ Pmod Board Image (Top)



Figure 5. US082-ZSSC3123EVZ Pmod Board Image (Bottom)

2.1 Schematic Diagrams

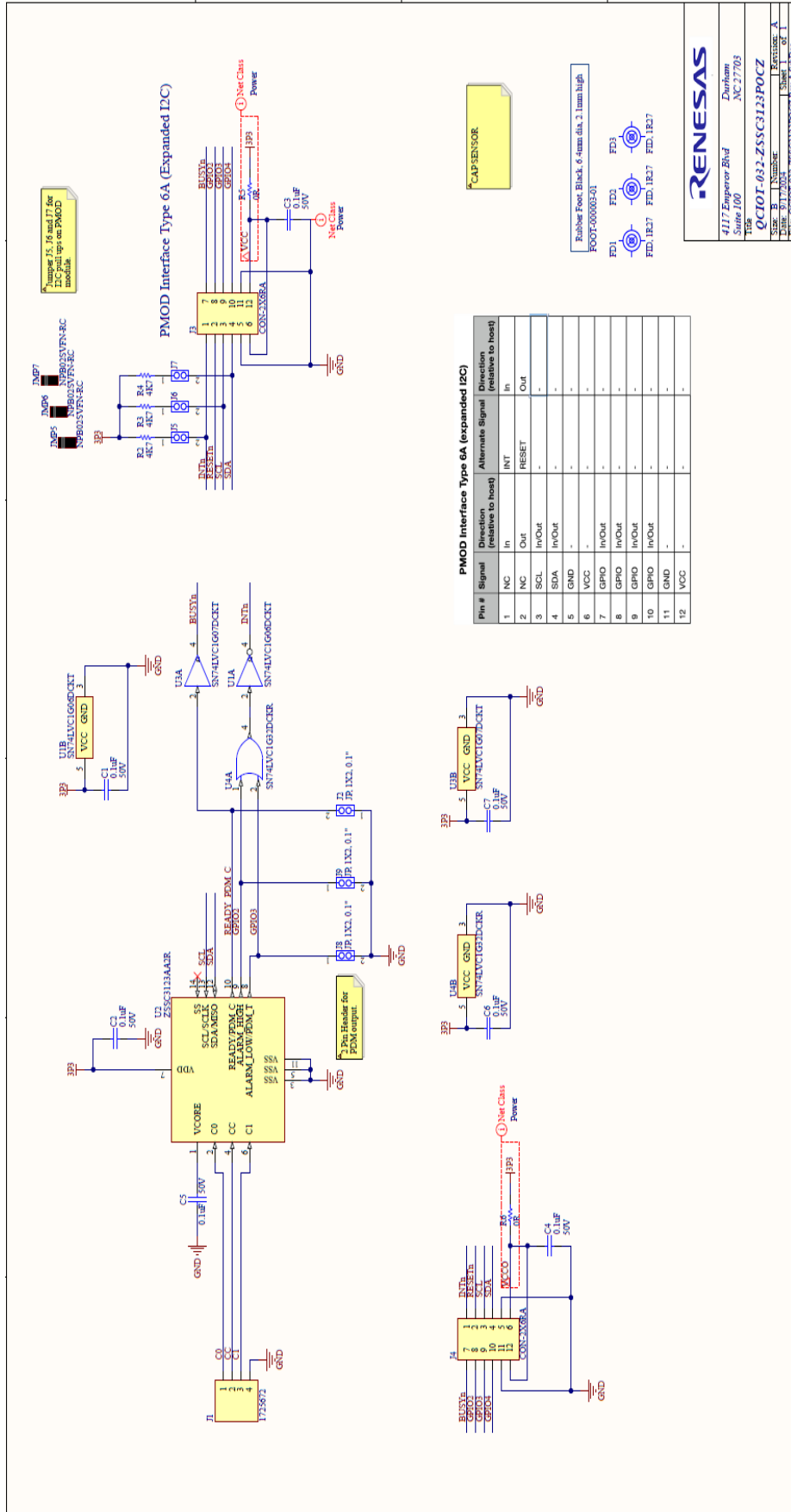

Figure 6. US082-ZSSC3123EVZ Pmod Board Schematic

2.2 Bill of Materials (BOM)

Qty	Reference Designator	Description	Manufacturer	Manufacturer Part Number
7	C1, C2, C3, C4, C5, C6, C7	Capacitor, 0.1 μ F, 50V, SM	Yageo	CC0603KRX7R9BB104
1	FOOT1	Foot, Rubber, Self-adhesive, Black, 6.4mm dia, 2.1mm tall	Bumper Specialties	BS25BL07X30RP
1	J1	Connector, 1x4, 2.54mm, RA, Terminal Block, TH	Phoenix Contact	1725672
3	J2, J8, J9	Jumper, 1x2, 0.1" Pitch	Sullins	PBC02SAAN
1	J3	Connector, 2x6, 0.1", Pmod, Header, Right Angle, Unshrouded	Harwin	M20-9950645
1	J4	Connector, 2x6, 0.1", Pmod, Socket, Right Angle	Samtec	613012243121
3	J5, J6, J7	Jumper, 1x2, 0.05" Pitch	Sullins	GRPB021VWVN-RC
3	JMP5, JMP6, JMP7	2 C, Closed Top, .050" CC; No Mounting, 105 C, Nylon 66; Phos Bronze, Gold Flash	Sullins	NPB02SVFN-RC
3	R2, R3, R4	Resistor, 4.7K ohms, 1/8W, 1%, SM	KOA Speer	RK73H1JTDD4701F
2	R5, R6	Resistor, 0 ohms, 1/8W, 1%, SM	KOA Speer	RK73Z1JTDD
1	U1	IC, Digital, Buffer, Triple, Inverting, Open Drain, SM	Texas Instruments	SN74LVC1G06DCKT
1	U2	Sensor Signal Conditioner, Capacitive Sensor, SM	Renesas	ZSSC3123AA2R
1	U3	IC, Digital, Buffer, Non-Inverting, Open Drain, SM	Texas Instruments	SN74LVC1G07DCKT
1	U4	IC, Digital, Gate, 2 Input OR, SM	Texas Instruments	SN74LVC1G32DCKR

2.3 Board Layout

Top Overlay (Scale 2:1)

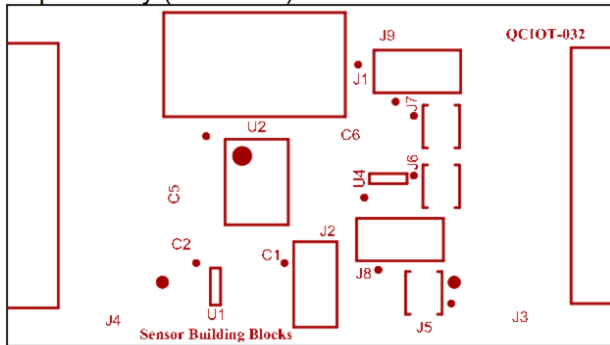

Figure 7. Top Overlay

Top Layer (Scale 2:1)

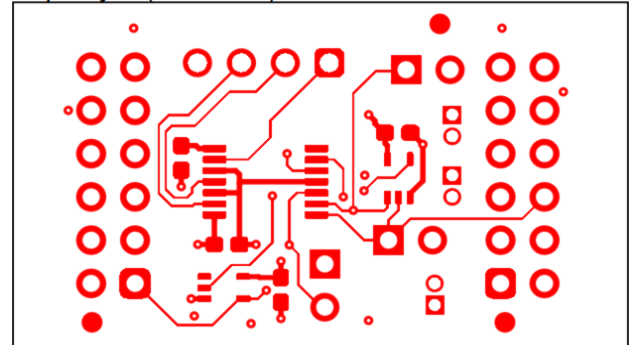

Figure 8. Top Layer

Int1 (GND) (Scale 2:1)

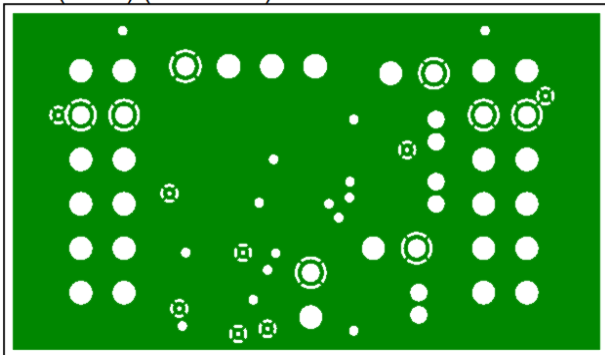

Figure 9. Layer 2 (GND)

Int2 (PWR) (Scale 2:1)

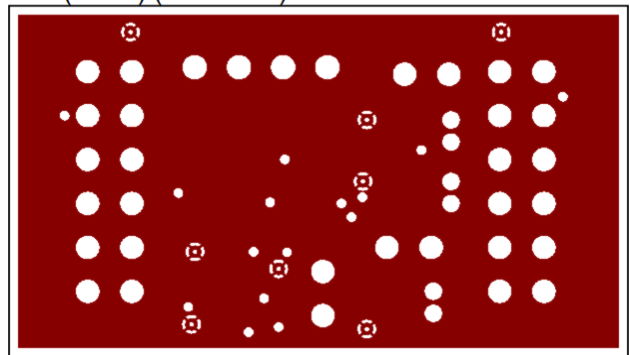

Figure 10. Layer 3 (Signal)

Bottom Layer (Scale 2:1)

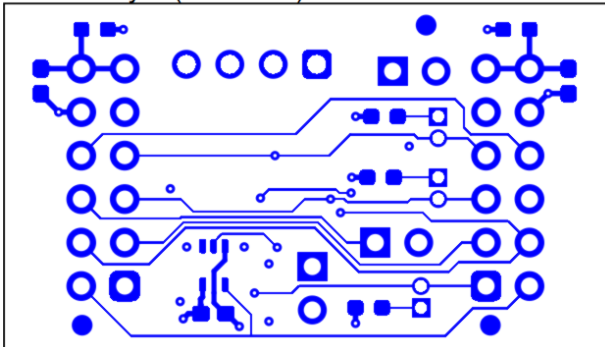

Figure 11. Bottom Layer

Bottom Overlay (Scale 2:1)

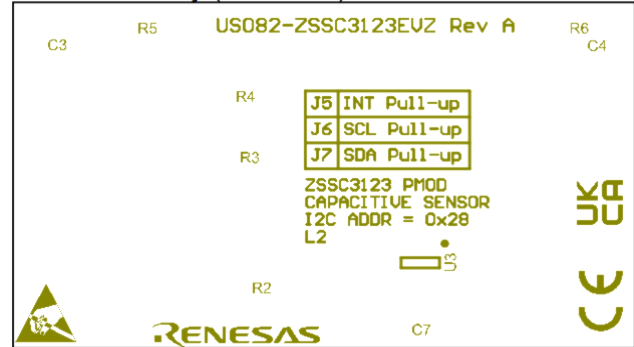

Figure 12. Bottom Overlay

3. Software Design

This section provides an overview of the software implementation for the US-082 ZSSC3123EVZ Pmod board, which is based on the Renesas RA Family's [Flexible Software Package](#) (FSP). It explains the project's code structure, the system's software modules, and the main system flow.

The provided demo sets the ZSSC3123 to command mode upon start-up and uses the RM_SSC3123_MeasurementStartComplete and RM_SSC3123_Read commands to periodically take temperature and capacitance measurements every 250ms. The capacitance is converted to a percentage and the temperature is converted to degrees Fahrenheit. The results from each measurement are stored in output array cap_temp_vals.

The ZSSC3123 supports single-ended, single-ended with external reference, and differential-ended mode measurement using the four pins on connector J1. To configure the desired connection of the capacitive sensor, see section 9.2.1.1, 9.2.1.2, and 9.2.1.3 of the device datasheet. This section shows the specification of the ZSSC3123 middleware.

For this demo, the ZSSC3123 is set to operate using pins CC and CC0 for capacitance measurements. For more information, see section 9.2 of the [ZSSC3123 Datasheet](#).

3.1 Project Code Structure

The Quick Connect project is designed to be a highly modular solution that can be easily configured independently of other modules (if required), or ported to other end applications.

Figure 13 shows the structure of the project in e2 studio.

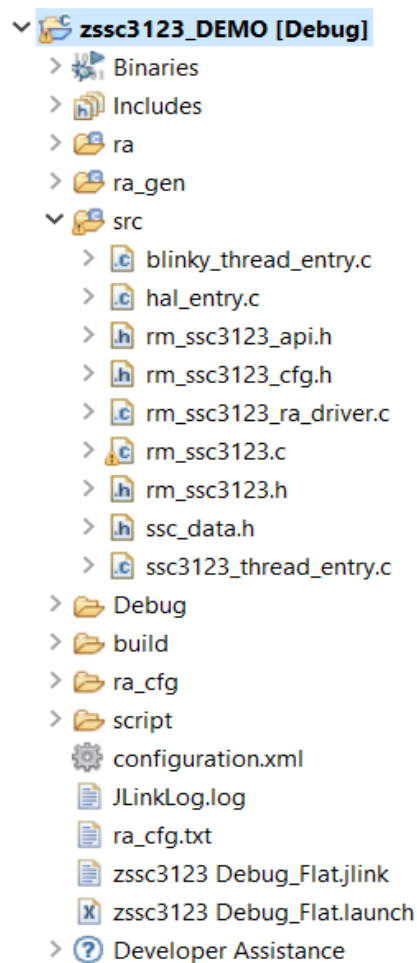

Figure 13. Project Structure

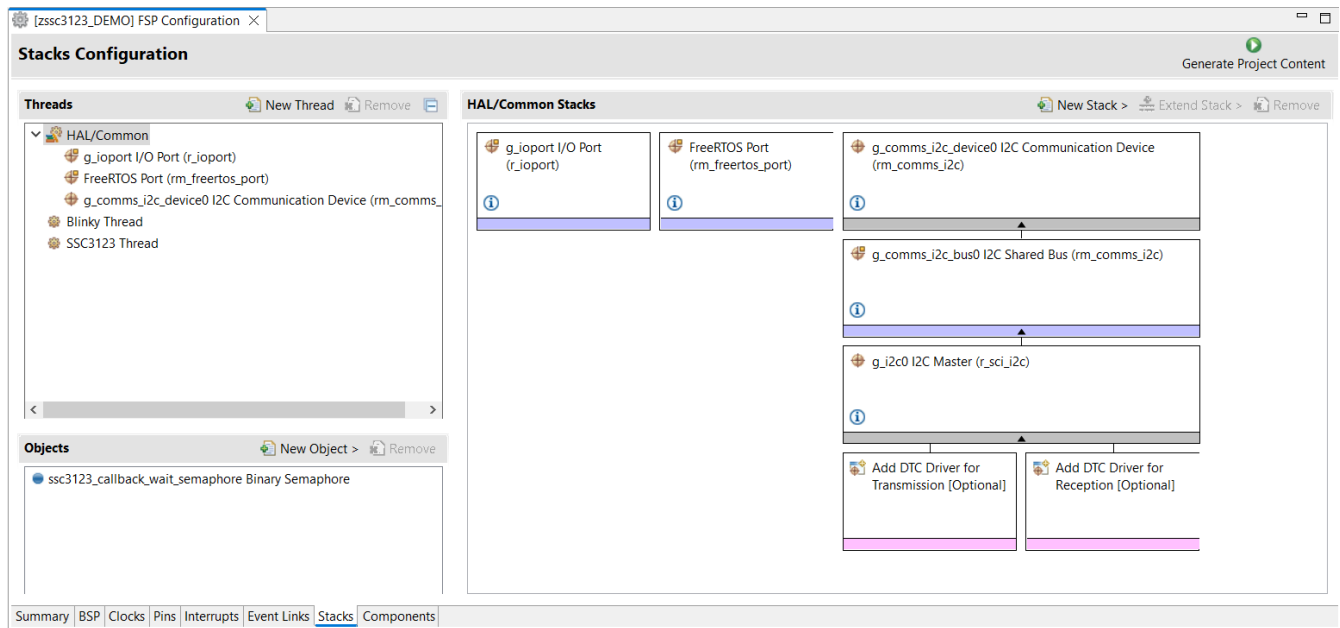

Figure 14. FSP Stacks

3.2 ZSSC3123 API

The ZSSC3123 middleware supports the following API calls:

API Call	Function
RM_SSC3123_Open	Opens connection between RA2E1 and ZSSC3123.
RM_SSC3123_Close	Closes connection between RA2E1 and ZSSC3123.
RM_SSC3123_MeasurementStartComplete	Ends command mode and transitions to Normal Operation mode for initiating measurement. See ZSSC3123 Datasheet (Table 25 and 29) for more info.
RM_SSC3123_SetCapRange	Takes desired capacitance range as input and sets the proper register bits, along with the resolution in the ZSSC3123 EEPROM Word. For more information, see Table 31 of the ZSSC3123 Datasheet.
RM_SSC3123_SetCapOffset	Takes desired capacitance offset/shift as input and sets the proper register bits in the ZSSC3123. For more information, see Table 31 of the ZSSC3123 Datasheet.
RM_SSC3123_ModeSelect	Changes operating mode of ZSSC3123 to Command mode. For more information, see Table 32 of the ZSSC3123 Datasheet.
RM_SSC3123_Read	Used after any of the measurement API calls to receive data from the ZSSC3123.
RM_SSC3123_Write	Writes commands to the ZSSC3123.
RM_SSC3123_SensorIdGet	Returns the ZSSC3123 Sensor Id.

Note: The first two bits in the first byte returned by RM_SSC3123_Read are the status bits. For more information, see Figure 19 in the ZSSC3123 Datasheet.

4. Board Test

4.1 Run Code in Debug Mode

1. Open the sample project code in Renesas e2 studio IDE.
2. From the menu bar, click on Run and choose Debug Configurations.

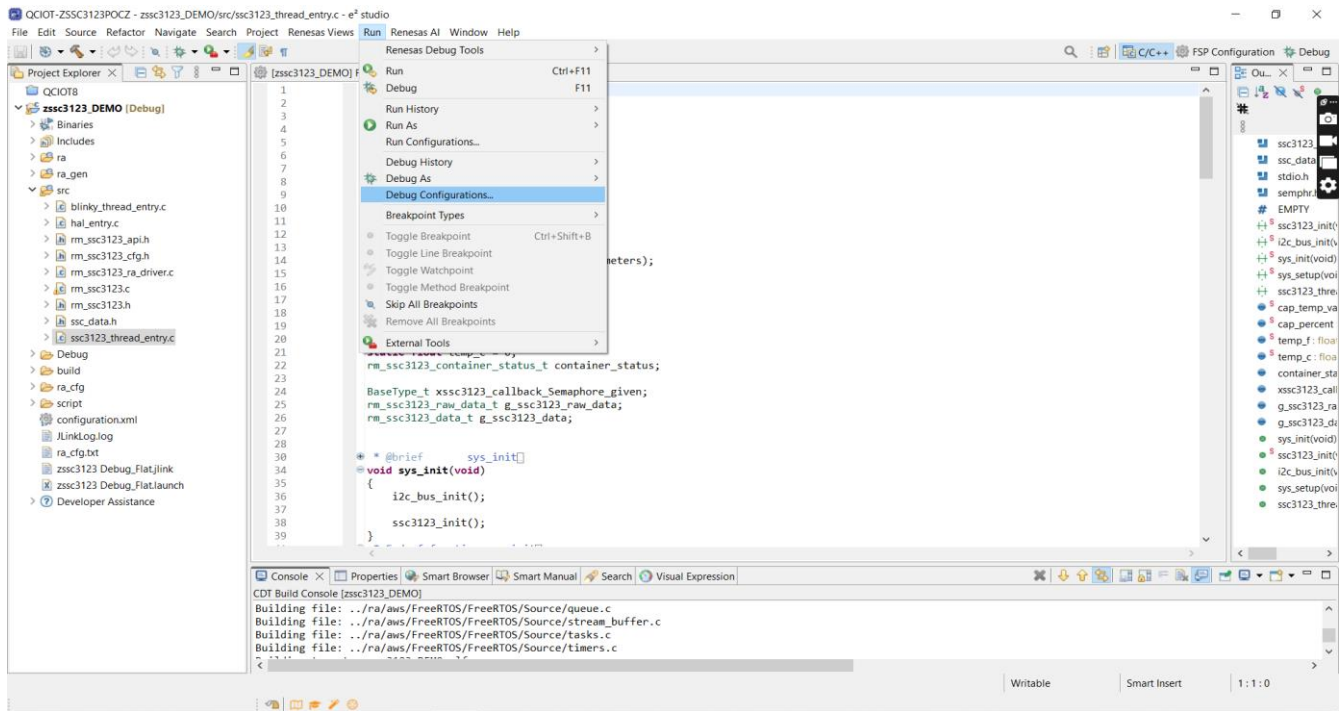

Figure 15. Debug Configuration

3. Select ZSSC3123_DEMO Debug under Renesas GDB Hardware Debugging, then click on the Debug button.

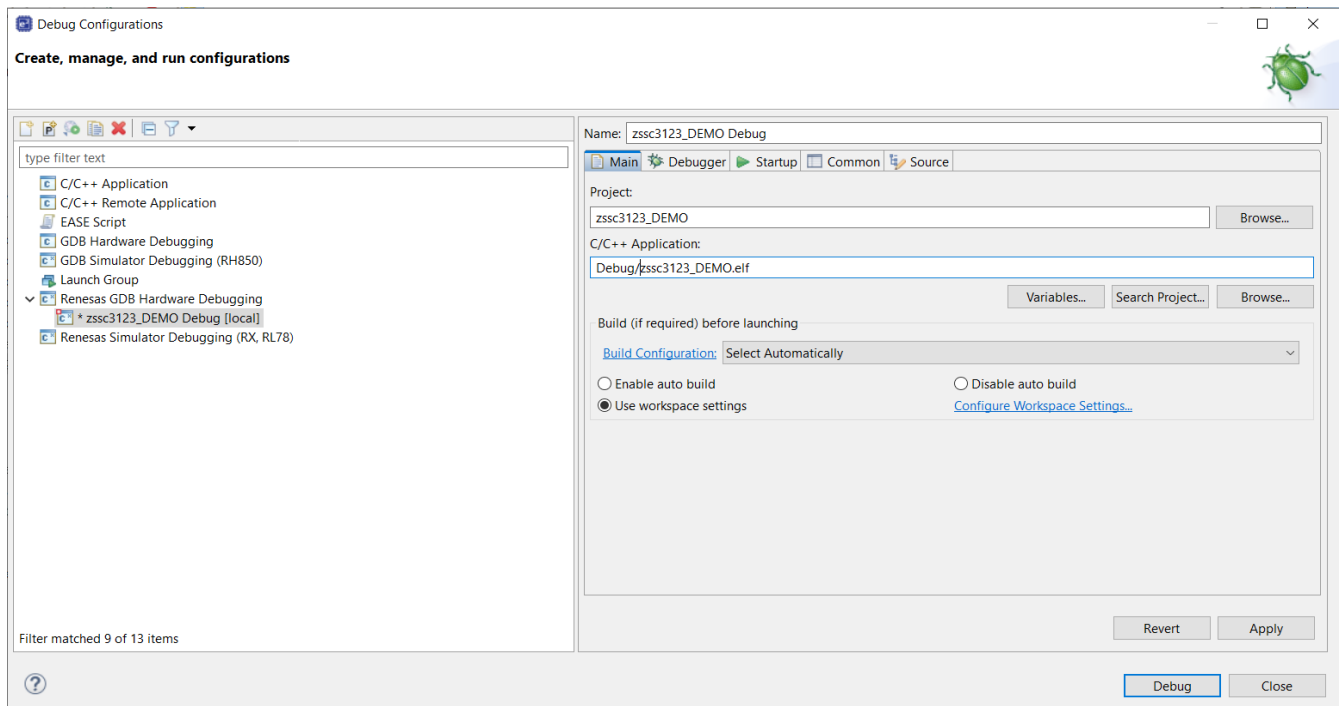

Figure 16. Start Debug Mode

4. The code will enter debug mode as shown below.

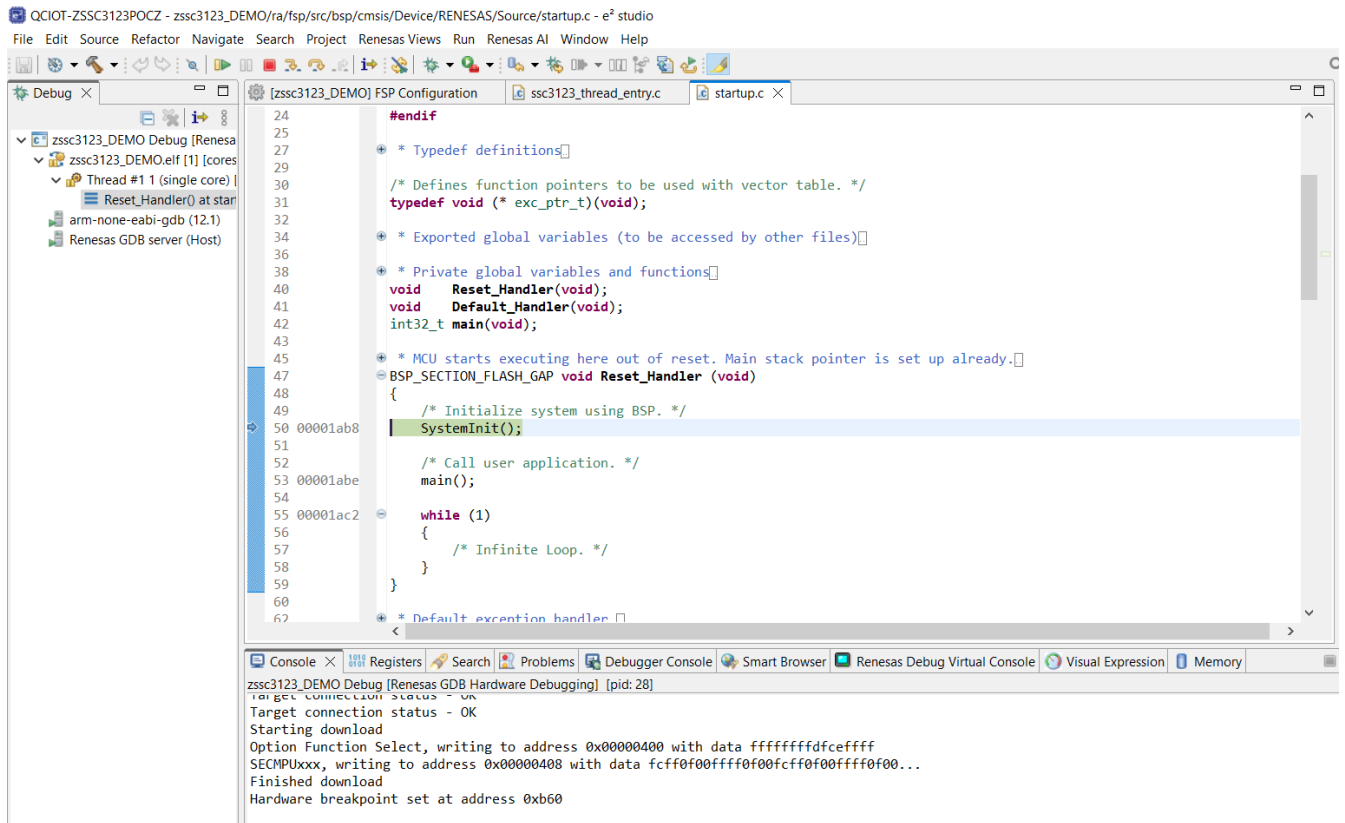

Figure 17. Code Debug Mode

5. Press F8 or click on the resume  icon to run the demo code.

4.2 Check Sensor Output

From the menu bar, click on Renesas Views/Debug/Visual Expression. Then, click on Windows/Show Views/Expressions (see Figure 18).

You should see the variables in the Expression window and Gauge icons in the Visual Expression windows. If not, you can add those variables manually. The capacitor reading and temperature reading will be available in real time.

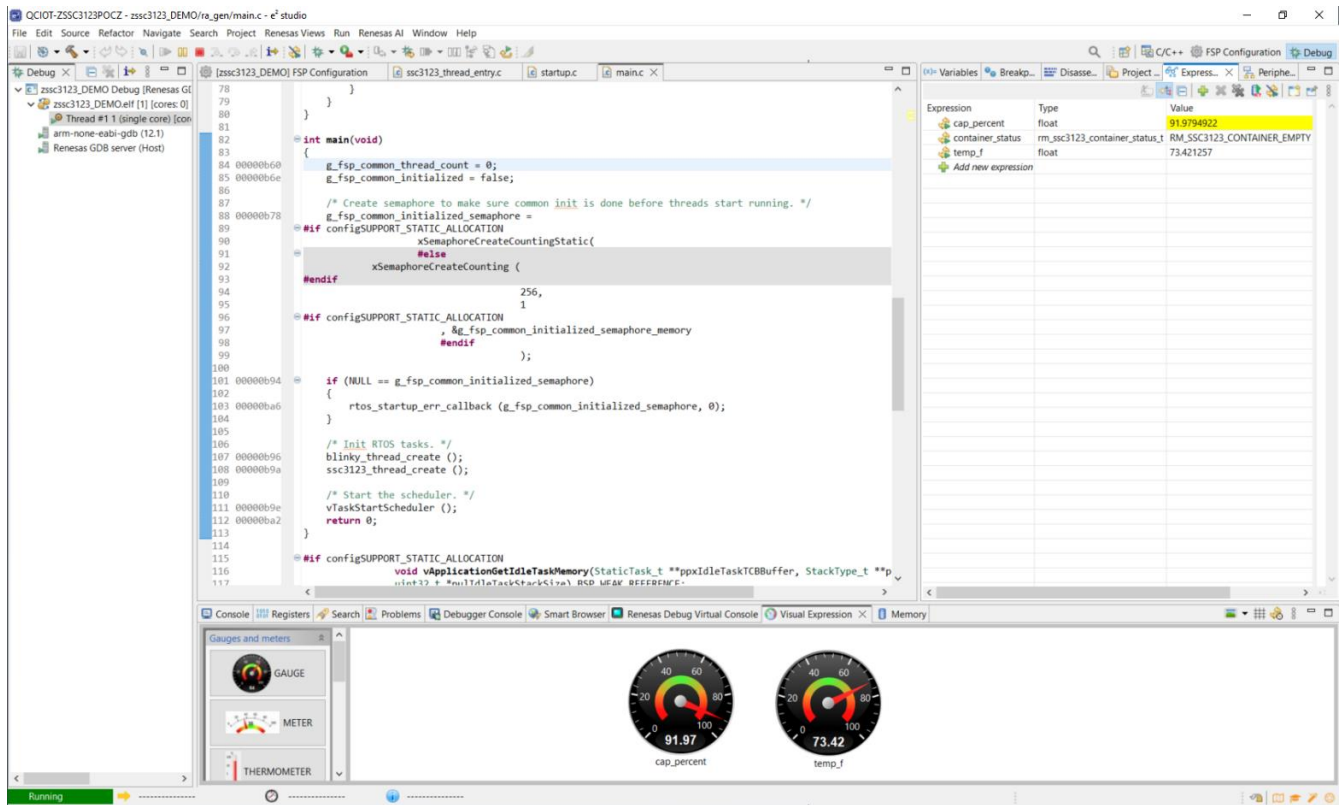

Figure 18. Sensor Reading

5. Ordering Information

Orderable Part Number	Description
US082-ZSSC3123EVZ	SSC3123 Pmod Board
US082-INTERPEVZ	Interposer Board

6. Revision History

Revision	Date	Description
1.00	Oct 18, 2024	Initial release.

IMPORTANT NOTICE AND DISCLAIMER

RENESAS ELECTRONICS CORPORATION AND ITS SUBSIDIARIES (“RENESAS”) PROVIDES TECHNICAL SPECIFICATIONS AND RELIABILITY DATA (INCLUDING DATASHEETS), DESIGN RESOURCES (INCLUDING REFERENCE DESIGNS), APPLICATION OR OTHER DESIGN ADVICE, WEB TOOLS, SAFETY INFORMATION, AND OTHER RESOURCES “AS IS” AND WITH ALL FAULTS, AND DISCLAIMS ALL WARRANTIES, EXPRESS OR IMPLIED, INCLUDING, WITHOUT LIMITATION, ANY IMPLIED WARRANTIES OF MERCHANTABILITY, FITNESS FOR A PARTICULAR PURPOSE, OR NON-INFRINGEMENT OF THIRD-PARTY INTELLECTUAL PROPERTY RIGHTS.

These resources are intended for developers who are designing with Renesas products. You are solely responsible for (1) selecting the appropriate products for your application, (2) designing, validating, and testing your application, and (3) ensuring your application meets applicable standards, and any other safety, security, or other requirements. These resources are subject to change without notice. Renesas grants you permission to use these resources only to develop an application that uses Renesas products. Other reproduction or use of these resources is strictly prohibited. No license is granted to any other Renesas intellectual property or to any third-party intellectual property. Renesas disclaims responsibility for, and you will fully indemnify Renesas and its representatives against, any claims, damages, costs, losses, or liabilities arising from your use of these resources. Renesas' products are provided only subject to Renesas' Terms and Conditions of Sale or other applicable terms agreed to in writing. No use of any Renesas resources expands or otherwise alters any applicable warranties or warranty disclaimers for these products.

(Disclaimer Rev.1.01)

Corporate Headquarters

TOYOSU FORESIA, 3-2-24 Toyosu,
Koto-ku, Tokyo 135-0061, Japan
www.renesas.com

Trademarks

Renesas and the Renesas logo are trademarks of Renesas Electronics Corporation. All trademarks and registered trademarks are the property of their respective owners.

Contact Information

For further information on a product, technology, the most up-to-date version of a document, or your nearest sales office, please visit www.renesas.com/contact-us/.