

Important Notes

Restrictions in Use

IDT’s ZSC31150 SSC Evaluation Kit, consisting of the Communication Board (SSC CB), the ZSC31150 Evaluation Board (SSC EB), and the calibration software, is designed for sensor module evaluation, laboratory setup, and module calibration development only.

IDT’s Evaluation Kit hardware and software must not be used for module production or production test setups.

Disclaimer

IDT shall not be liable for any damages arising out of defects resulting from

- (i) delivered hardware or software
- (ii) non-observance of instructions contained in this manual and in any other documentation provided to user, or
- (iii) misuse, abuse, use under abnormal conditions, or alteration by anyone other than IDT.

To the extent permitted by law, IDT hereby expressly disclaims and user expressly waives any and all warranties, whether express, implied or statutory, including, without limitation, implied warranties of merchantability and of fitness for a particular purpose, statutory warranty of non-infringement, and any other warranty that may arise by reason of usage of trade, custom or course of dealing.

Contents

1	Kit Content.....	4
2	ZSC31150 Evaluation Board.....	5
	2.1. Overview.....	5
	2.2. Schematic.....	5
	2.3. Connections to the ZSC31150	6
	2.4. Reset Button	6
3	ZSC31150 Software	7
	3.1. Overview and Software Installation	7
	3.2. USB Driver Installation	8
	3.3. User Files.....	8
	3.4. General Setup of the Software	9
	3.4.1. Interface Selection	10
	3.4.2. ZSC31150 Configuration	10
	3.4.3. Analog Front End (AFE) Adjustment.....	11
	3.4.4. Temperature Sensor Selection	11
	3.4.5. ADC Settings.....	11
	3.4.6. Application Settings	12
	3.5. Operation Sections	13
	3.5.1. “Commands” Section: Normal Operation Mode (NOM).....	13

- 3.5.2. "Commands" Section: Command Mode (CM) 13
- 3.5.3. "Commands" Section: Power ZSC31150 Off..... 13
- 3.5.4. Read-Out Data Section: Options for Reading Data 14
- 3.5.5. Read-Out Data Section: Enable Error Check 14
- 3.5.6. Average Count and Statistics..... 14
- 3.6. Output Configuration 14
- 3.7. Calibration Window..... 15
- 3.8. "RAM-Register" Dialog Window..... 15
- 3.9. Get Raw Values Dialog 16
- 3.10. Send Command..... 16
- 4 Calibration Demonstration 18
 - 4.1. Hardware Setup..... 18
 - 4.2. Software Startup..... 19
 - 4.3. Calibration Data Acquisition 19
 - 4.4. Calculation of the Coefficients and Limits 20
- 5 Ordering Information 21
- 6 Related Documents..... 21
- 7 Glossary 22
- 8 Document Revision History..... 23

List of Figures

Figure 1.1	ZSC31150 Evaluation Kit.....	4
Figure 2.1	ZSC31150 SSC Evaluation Board – Overview.....	5
Figure 2.2	SSC Evaluation Board Schematic.....	6
Figure 3.1	Main Window of the Evaluation Software.....	9
Figure 3.2	Interface & Board Version.....	10
Figure 3.3	DUT Configuration.....	10
Figure 3.4	Sensor Adaptation and Sensor Mode Sections.....	11
Figure 3.5	Temperature Sensor.....	11
Figure 3.6	ADC Adjust.....	11
Figure 3.7	Application Settings.....	12
Figure 3.8	Operation Sections.....	13
Figure 3.9	Output Selection.....	13
Figure 3.10	Data Read-Out.....	14
Figure 3.11	“Interface & Board Version” Section.....	14
Figure 3.12	“Sensor – Calibration” Dialog.....	15
Figure 3.13	Displaying RAM-EEP Register Contents.....	15
Figure 3.14	“Get Raw Values” Dialog.....	16
Figure 3.15	“Send Command” Dialog.....	17
Figure 4.1	Inserting the ZSC31150 into the Socket.....	18
Figure 4.2	AFE Configuration.....	19
Figure 4.3	Calibration Results.....	20

1 Kit Content

The ZSC31150 Evaluation Kit consists of the following parts:

- SSC Communication Board (SSC CB) V4.1 (including USB cable) *
- ZSC31150 SSC Evaluation Board (SSC EB) V1.0
- SSC Sensor Replacement Board (SRB) V2.0
- 5 samples of the ZSC31150 (SSOP14)

Note: The ZSC31150 Evaluation Kit Software is downloaded from www.IDT.com/ZSC31150KIT as described in section 6.

Figure 1.1 ZSC31150 Evaluation Kit

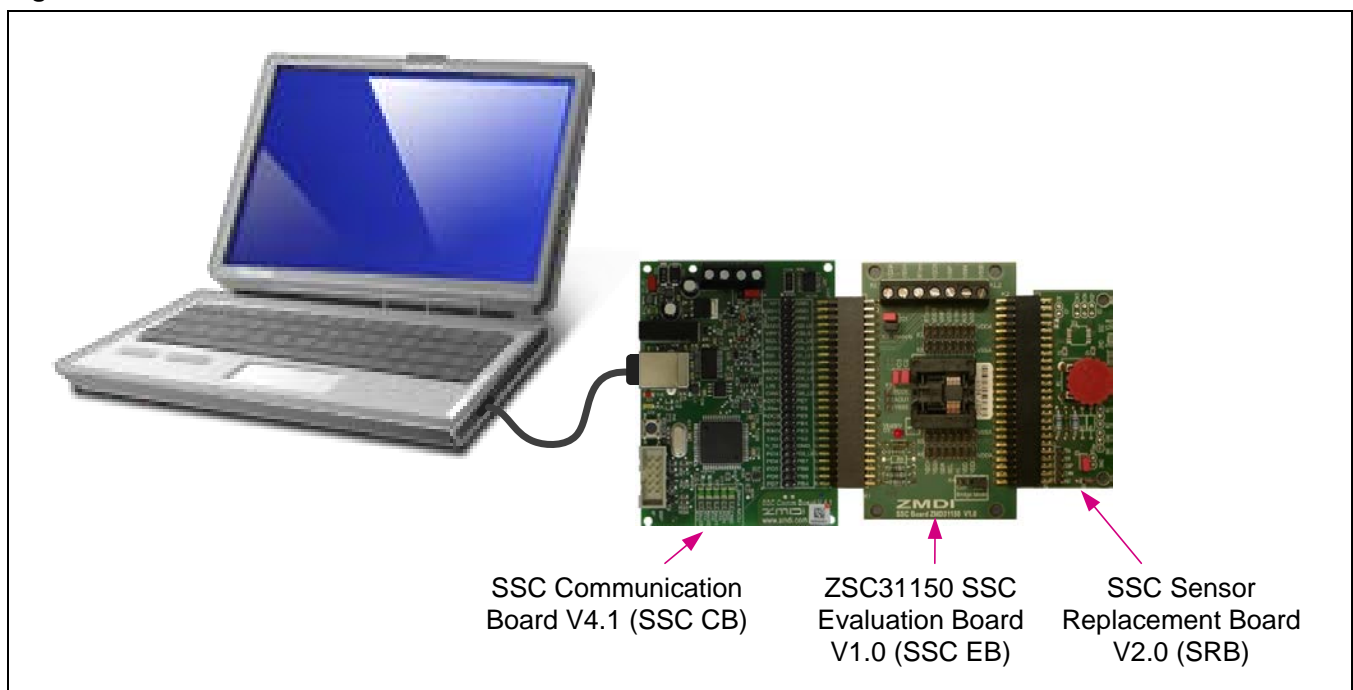

The SSC Evaluation Kit contains the hardware needed for communication and calibration of ZSC31150 sensor signal conditioning ICs. A PC can communicate with the ZSC31150 via the Communication Board (SSC CB) through a USB connection. The Sensor Replacement Board (SRB) provides a replacement for an actual sensor for demonstration purposes only, which can be helpful for setting up calibration as described in section 4. On the SRB, the sensor replacement signal is controlled by a potentiometer (see Figure 4.1). For the actual application calibration, the user's sensor module can be connected via screw terminals on the SSC Evaluation Board.

The software will run under Windows® 98/ME/XP/NT/Vista/Windows® 7/Windows® 8 operation systems.

Note: If the CB revision is earlier than V3.3, installation of a USB driver is required before installing the software (refer to the *SSC Communication Board Data Sheet*).

* For detailed information about SSC Communication Board, please refer to the *SSC Communication Board Data Sheet* available on the IDT website at <http://www.IDT.com/SSC-COMM-BD>.

2 ZSC31150 Evaluation Board

2.1. Overview

Figure 2.1 ZSC31150 SSC Evaluation Board – Overview

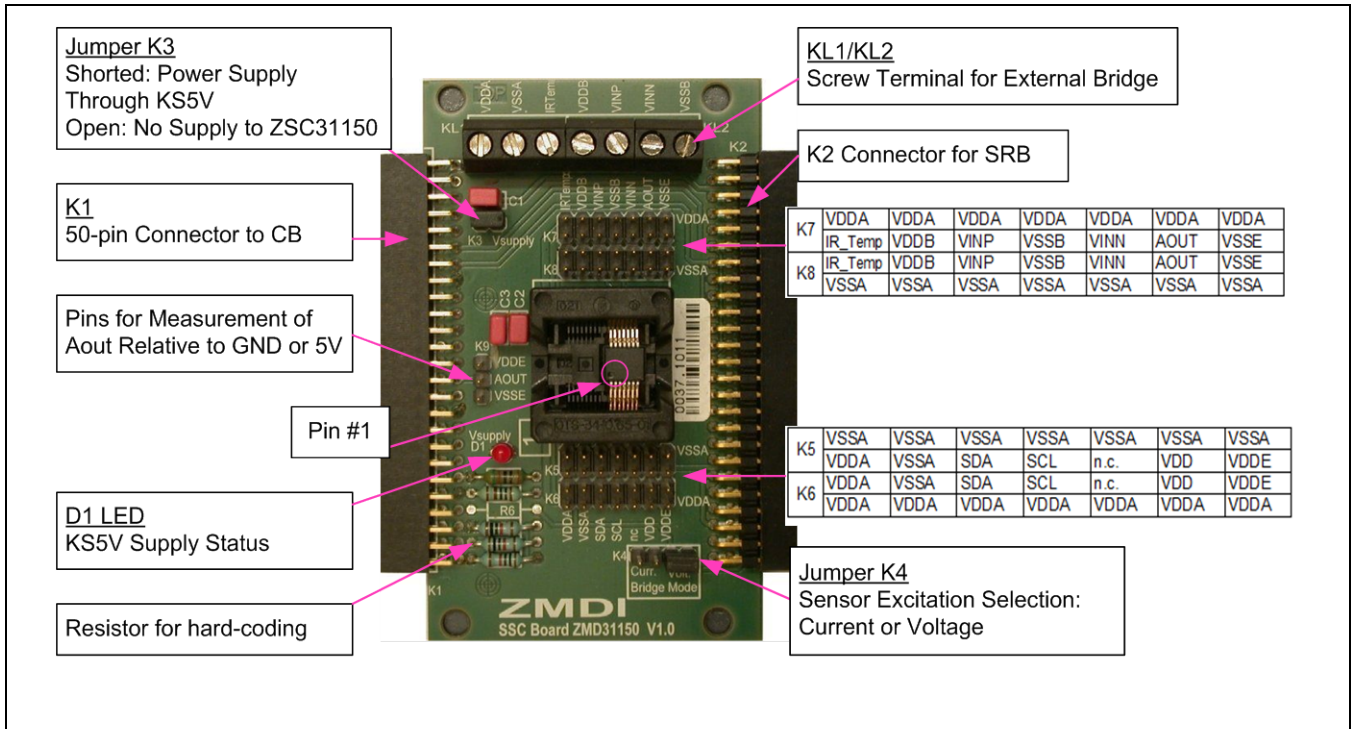

The main purpose of the SSC Evaluation Kit is communication between the user's PC and the ZSC31150. The PC sends commands and data via its USB port (configured as a virtual COM port) to the SSC CB. The microcontroller (μ C) on the SSC CB interprets these commands and relays them to the ZSC31150 in the I²C™† or OWI (One-Wire Interface) communication mode. The μ C will also forward any data bytes from the ZSC31150 back to the PC via the USB connection. These bytes can be sensor and temperature readings to be displayed by the PC software, raw ADC data used during calibration, or EEPROM data. The SSC CB μ C controls the power signals required for entering the Command Mode.

2.2. Schematic

Figure 2.2 shows the schematic of the ZSC31150 SSC Evaluation Board (SSC EB). The SSC EB is powered by the KS5V supply controlled by the μ C on the SSC CB. The D1 red LED on the SSC EB displays the status of this supply (see Figure 2.1). Its forward current is not included in the measured supply current.

Jumper K3 can be used to manually remove the power supply for the ZSC31150 or for a simple measurement of the supply current.

† I²C™ is a trademark of NXP.

Figure 2.2 SSC Evaluation Board Schematic

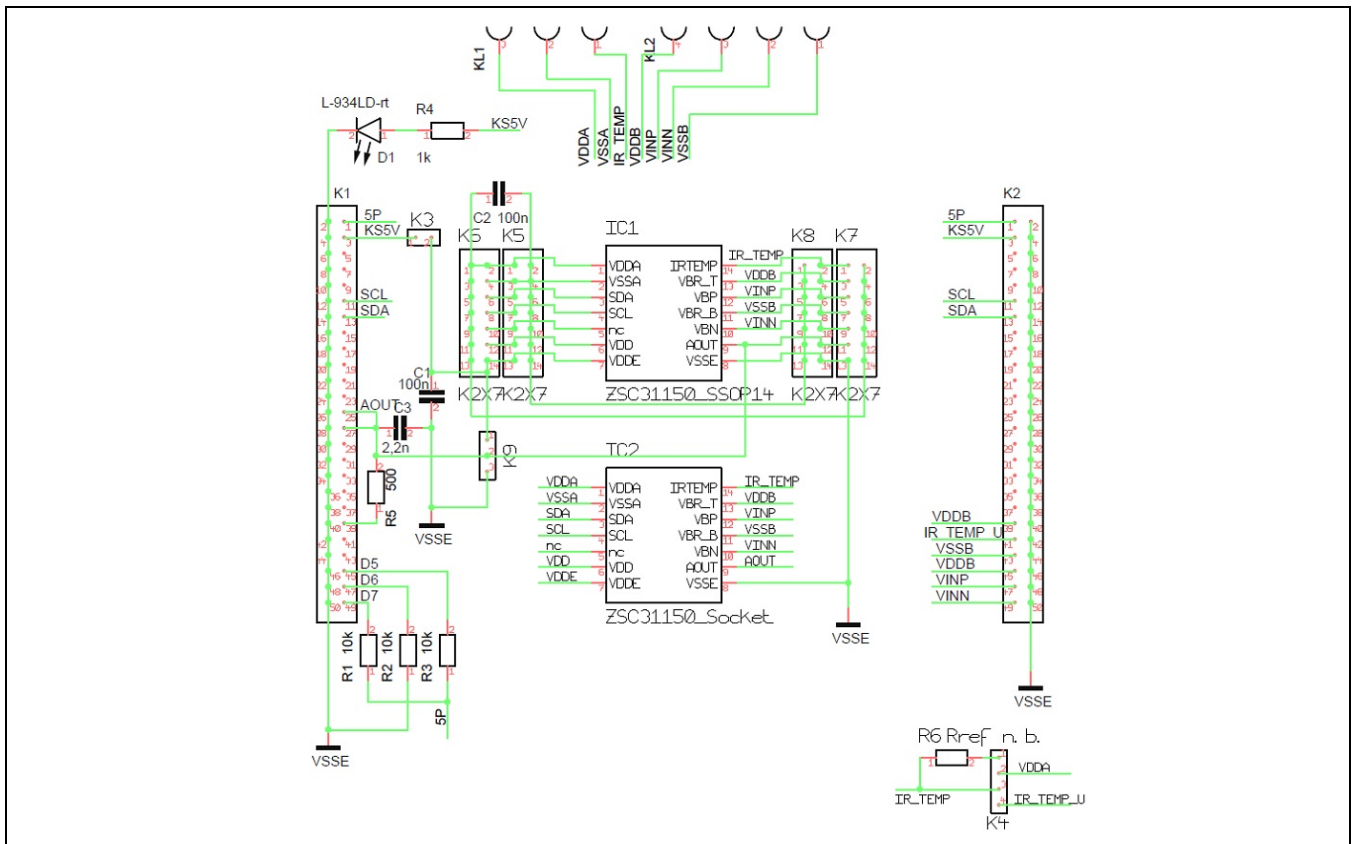

The SSC EB is connected to the SSC CB via the K1 50-pin female connector. The SSC EB board type is hard-coded by three resistors on K1 connector pins D7 (high), D6 (low), and D5 (high). On the SSC EB, there are several pin-header strips for simple access to all IC signals (K5, K6, K7 and K8).

The SRB can be connected to the SSC EB via the K2 50-pin male connector. Alternatively, the user's external bridge sensor element and/or an external temperature sensor can be connected using the on-board screw terminal KL1/2. Do not connect the user's sensor(s) at the same time as the SRB.

2.3. Connections to the ZSC31150

The SSC EB has an SSOP14 socket for inserting the ZSC31150 SSOP14. Note the pin orientation shown in Figure 2.1. For more details, also see Figure 4.1.

The connectors K5 to K8 on the SSC EB can be used to connect directly to the ZSC31150 for in-circuit programming. NOTE: Only one ZSC31150 connection option can be used at a time (i.e., either through the SSC CB or via individual connections).

2.4. Reset Button

Use the push button on the SSC CB to reset communications if needed. See Figure 4.1 for the location of the button.

3 ZSC31150 Software

3.1. Overview and Software Installation

The ZSC31150 Evaluation Software provided is intended for demonstration purposes and calibration of single units. This section gives installation instructions and a short overview of the variety of ways to use this evaluation software. For calibration examples using the complete SSC Evaluation Kit, refer to section 4. IDT can provide users with algorithms and assistance in developing their full production calibration software.

Note: If using a previous revision SSC CB, see section 3.2 regarding USB drivers that must be installed prior to the ZSC31150 Evaluation Software.

The ZSC31150 Evaluation Kit does not include the software, which must be downloaded from the IDT website (www.IDT.com) to ensure receiving the latest release.

To download the software, follow these steps:

1. Navigate to the ZSC31150 product page: www.IDT.com/ZSC31150
2. Download the “ZSC31150 Evaluation Software Rev. X” (where X is the current revision) and follow the dialog instructions as needed to download the zip file for the software.
3. Open the zip file and extract the executable file *ZSC31150_rev.X.xxx.exe*.
4. To install the software on the user’s PC hard drive, double-click on the downloaded *extracted* executable file. Respond to the dialog box to select the installation directory. The default software installation folder is *C:\program files\ZMDI\ZSC31150*. The software will automatically complete the installation, which results in a program shortcut on the desktop of the PC:



The software logs various data and commands into log files as described in section 3.3.

The software contains five menus that are intended for the following functions:

- Main Window: IC setup, configuration, and communication via check boxes, entry fields, and pull-down menus
- RAM/EEPROM Dialog: Direct access to RAM/EEPROM registers (consecutively numbered)
- Calibration Dialog: Acquisition of raw values from sensor and calculation of coefficients
- Get Raw Values Dialog: Special Dx commands for the ZSC31150[‡]
- Send Command Dialog: Low-level write/read communication with SSC CB[§]

[‡] For details about the Dx commands, refer to the *ZSC31150 Functional Description*.

[§] For details about SSC CB command structure, refer to the *SSC Communication Board Data Sheet* and *SSC Command Syntax Spreadsheet*.

3.2. USB Driver Installation

USB driver installation is not applicable to the current version ZSC31150 Evaluation Kit because it includes the current version of the SSC CB (rev. 4.1). The USB driver installation is only required if the CB revision is the previous version V3.3 or earlier. For more information, refer to the *SSC Communication Board Driver Installation Application Note* available on <http://www.IDT.com>.

3.3. User Files

User files are saved in *[Program Files]\ZMDI\ZSC31150* and consist of log files and EEPROM files.

- *ZSC31150_*.log* is a communication log file created when the connection between the SSC CB and the ZSC31150 is established (via OWI or I²C™ ** interface). To enable logging, after activating the software, navigate to “Calibration” > “Send Command” and check the box for “logFile.” This file is a log of the communication to the ZSC31150 during the software session and can be saved after closing the software by renaming the file. Otherwise, it is overwritten the next time the software is opened.
- *save_[date]_[time].31150* is a log file containing the ZSC31150 settings and acquired RAW data. This file can be used to load/save EEPROM contents.
- *save_[date]_[time].31150_txt* is a log file in text format containing the ZSC31150 settings and acquired RAW data. This file can be used to view the EEPROM contents.

** I²C is a registered trademark of NXP.

3.4. General Setup of the Software

Install the software as described in section 3.1.

Because of the large number of different functionalities of the ZSC31150, the user interface is divided into different sections. Within each section, a number of associated functionalities are implemented. Several submenus allow access to sub-functionalities. After the ZSC31150 Evaluation Software is started, the main window is displayed (see Figure 3.1). When communication is established with a ZSC31150 inserted in the socket on the SSC EB, the software can be adapted to the IC's configuration by clicking the **RdRAM&Set** button on the main window in the "DUT Configuration" section.

Figure 3.1 Main Window of the Evaluation Software

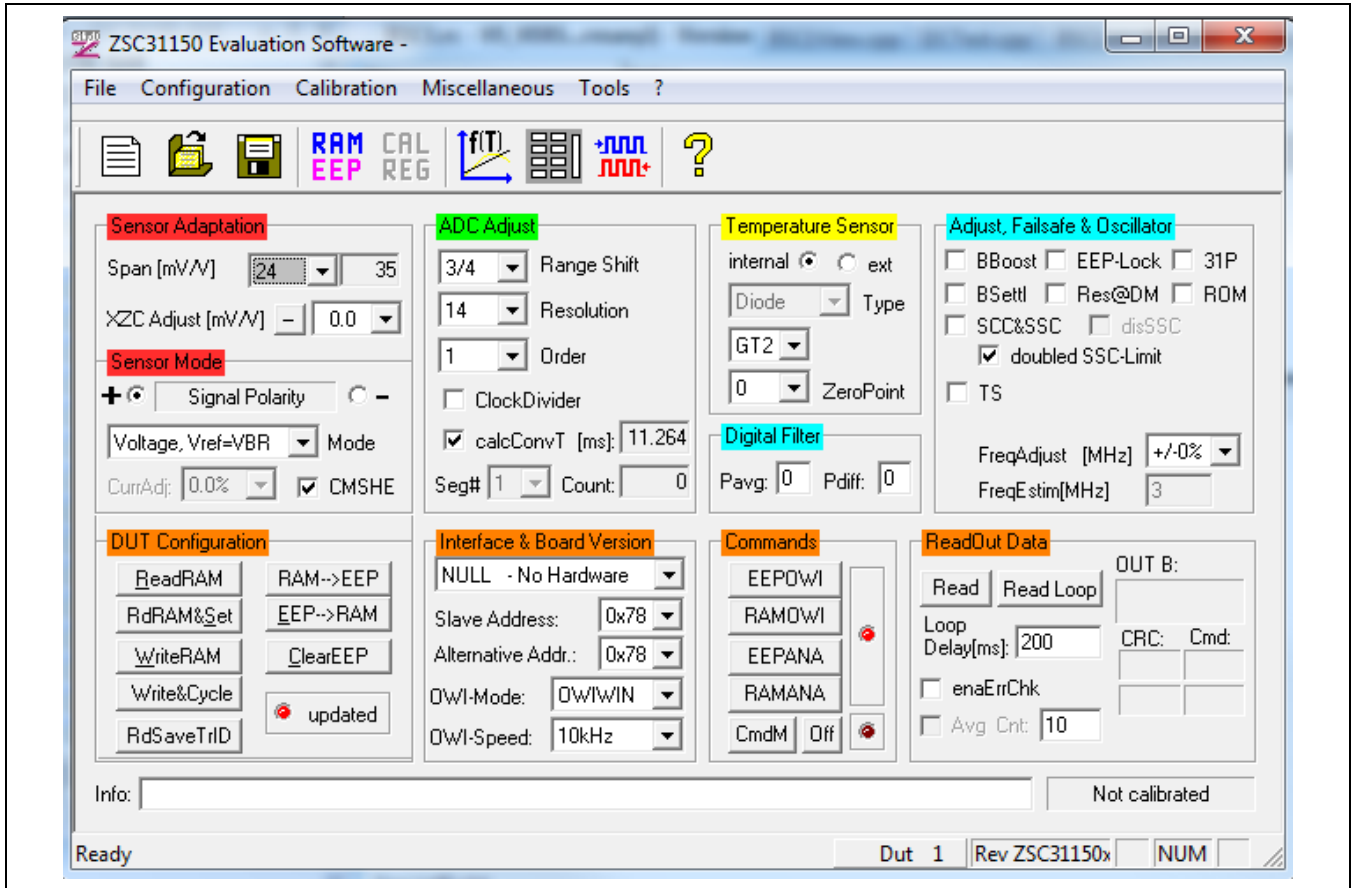

The main window includes all the settings for configuration of the ZSC31150 in a clear structure that hides the corresponding HEX commands behind buttons and pull down menus. For a detailed description of the commands, refer to the *ZSC31150 Functional Description*. An information box that explains functionality appears when the cursor is placed over most buttons, drop-down menus, and check boxes.

3.4.1. Interface Selection

The ZSC31150 supports two interfaces: the one-wire digital interface (OWI) and the I²C™ interface. After starting the software, select the interface for the application in the “Interface & Board Version” section.

Below the drop down menu for the interface, there is a menu for selecting the I²C™ addresses to be used. Enter the ZSC31150’s general address using this menu. There is also an option to use an alternative address. Refer to the *ZSC31150 Functional Description* for more details.

The one-wire digital interface (OWI) combines a simple and easy protocol adaptation with a cost-saving pin sharing (A_{OUT}). The communication principle is derived from the I²C™ protocol. An advantage of OWI output signal capability is that it enables “end of line” calibration. It is designed mainly for calibration, but it may also be used to digitally read the calibrated sensor signal continuously.

Figure 3.2 Interface & Board Version

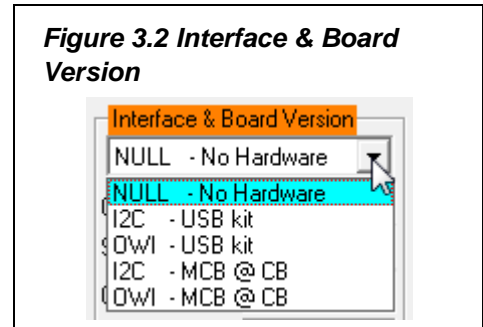

3.4.2. ZSC31150 Configuration

The “DUT Configuration” section includes the following buttons:

- **ReadRAM** : reads the complete RAM contents and updates only the “RAM_Register” menu.
- **RdRAM&Set** : reads the complete RAM contents and updates all of the ZSC31150 software.
- **WriteRAM** : copies the current software settings into the RAM of the ZSC31150.
- **RAM-->EEP** : copies the RAM contents into EEPROM. Also, the free-user-memory registers (10_{HEX}, 11_{HEX} and 12_{HEX}) will be copied using the contents of the IDT software registers^{††}.
- **EEP-->RAM** : copies the EEPROM contents into RAM using the C0_{HEX} command.
- **Write&Cycle** : copies the current software settings into the RAM of the ZSC31150 and starts the measurement cycle using the current RAM settings (command: 02_{HEX}^{††}).
- **RdSaveTrID** : Read and save traceability information (the contents of three free-user-memory registers 10_{HEX}, 11_{HEX} and 12_{HEX}).
- **ClearEEP** : Clears the EEPROM contents.

Figure 3.3 DUT Configuration

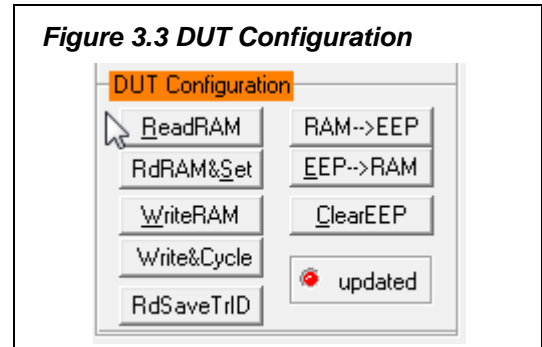

The “updated” simulated LED displays the software configuration status compared with the attached IC’s register contents. If the content is identical, the LED is green (on).

^{††} The contents of the “RAM-Register” dialog will be used for free-user-memory registers.

^{††} For details about ZSC31150 commands, refer to the *ZSC31150 Functional Description*.

3.4.3. Analog Front End (AFE) Adjustment

The ZSC31150 has different options for adapting the analog front end (AFE) to the specific sensing element. The “Sensor Adaptation” and “Sensor Mode” sections (see Figure 3.4) configure the programmable gain amplifier (PGA) and the extended zero compensation (XZC). Refer to the *ZSC31150 Data Sheet* and *ZSC31150 Functional Description* for details about PGA and XZC settings.

The “Mode” drop-down menu in the “Sensor Mode” section selects the bridge excitation mode (current or voltage; CFGAPP:CSBE) and the ADC conversion reference voltage (CFGAPP:BREF). The polarity of the sensor signal can be selected by the radio button if the circuit board layout requires swapped input pins.

If checked when the sensor current excitation mode has been selected, the CMSHE (common mode shift enable) checkbox (configuration word CFGAPP:CMSHE), enables common mode regulation. If CMSHE is checked when the sensor voltage excitation mode is selected, it connects VSSA to VBR_BOT and VDDA to VBR_TOP. Always enable CMSHE if either of the two voltage excitation modes is selected with the “Mode” menu.

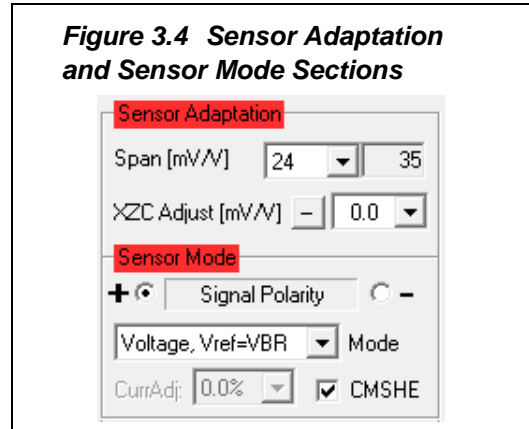

Figure 3.4 Sensor Adaptation and Sensor Mode Sections

3.4.4. Temperature Sensor Selection

The next stage in the AFE is the multiplexer that selects the input signal for measuring temperature. The ZSC31150 can use two different temperature channels: one for the temperature that is used for the ZSC31150’s internal calibration calculation and one that is used as an optional additional output signal during Normal Operation Mode (NOM). The “Zero Point” setting can be used to select different reference voltages to shift the single-ended temperature signal as needed for a differential ADC input during temperature measurement. Refer to section 6.1 in the *ZSC31150 Functional Description* for more details.

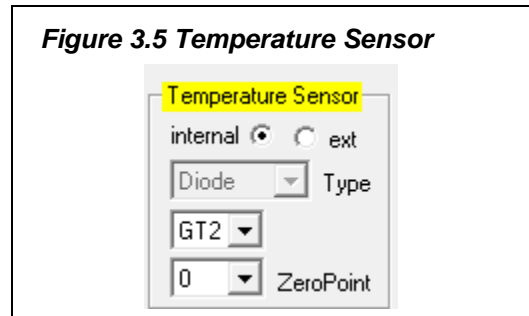

Figure 3.5 Temperature Sensor

3.4.5. ADC Settings

The last stage of the AFE is the ADC. The signal path within the AFE is fully differential, so it is necessary to provide an input signal within the common mode range. Otherwise, the ADC will provide a signal that is equal to 0000_{HEX} (underflow) or 2^{ADC_Resolution} (overflow) in the “Sensor – Calibration” menu during calibration. Refer to the *ZSC31150 Data Sheet* for details about ADC settings.

If the analog input voltage does not fit the ADC range and an underflow or overflow occurs, the “Range Shift” option can be used for fine-tuning. A lower “Span” setting in the “Sensor Adaptation” section (see section 3.4.3) can also be useful for fitting the ADC range. The first-order ADC is more robust and noise immune while the second-order ADC is faster.

If enabled by the “calcConvT” check box, the adjacent field gives a rough estimate of the analog-to-digital conversion time.

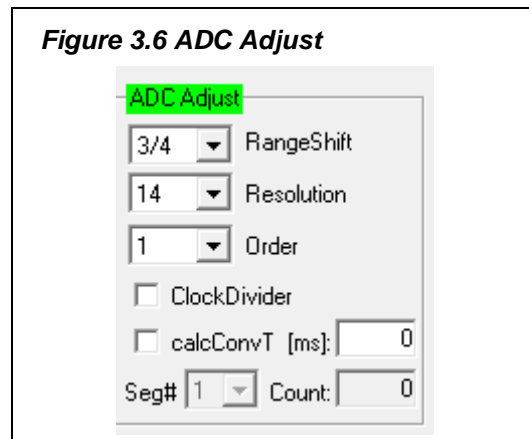

Figure 3.6 ADC Adjust

The “Seg#” drop-down menu selects the number of 2^{13} counts subtracted from the measurement result value during the range zooming procedure for ADC resolutions greater than 14 bits. Refer to the *ZSC31150/ZSSC3138 Application Note – Range Zooming* for more details.

3.4.6. Application Settings

The internal microcontroller of the ZSC31150 can detect various errors and perform different types of measurement cycles. It controls multiple protection options that can be configured by the ZSC31150 evaluation software. The `enaErrChk` checkbox in the “ReadOut Data” section enables the ZSC31150 software to respond to any of the selected protection options by analyzing the error flags sent by the ZSC31150.

Protection options are enabled/ disabled via checkboxes in the “Adjust, Failsafe & Oscillator” section (see Figure 3.7). For more details about the related options, refer to the *ZSC31150 Functional Description*.

- `BBoost` : Activates bias boost functionality. If enabled, bias current is increased. This is recommended for clock frequencies greater than 3MHz.
- `EEP-Lock` : Enables the EEPROM lock for OWI communication. If enabled, the EEPROM cannot be changed via the OWI interface. It can only be reset via the I²C™ interface.
- `31P` : If enabled, 30 sensor signal measurements instead of 1 measurement will be processed in a measurement loop.
- `BSettl` : If enabled, an A/D conversion time is added for output voltage settling in NOM.

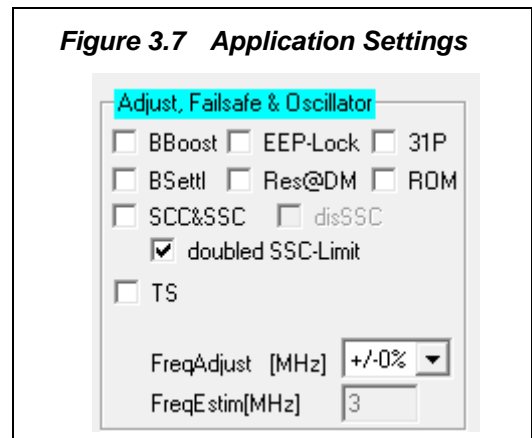

- `Res@DM` : If enabled, the ZSC31150 is reset if the ZSC31150 enters the Steady Diagnostic Mode.
- `ROM` : Enables the ROM check after power on. If enabled, the start-up time will be increased by approximately 10ms. If a ROM error occurs, the ZSC31150 will change to the Diagnostic Mode.
- `SCC&SSC` : If enabled, the sensor connection and sensor short checks monitor the connection of the sensor.
- `Doubled SSC-limit` : Activates the enhanced sensor short check limit. The lower limit for short detection is 1750 counts if this checkbox is not enabled; the enhanced limit is 2240 counts if enabled.
- `TS` : If enabled, temperature sensor ADC result (equivalent to `cmd:\\"D1\"`) is checked for being within the range $(0; 2^{\text{resolution}})$.
- `FreqAdjust[MHz]` : Clock frequency adjustment.
- `FreqEstim [MHz]` : Estimated oscillator frequency.

3.5. Operation Sections

The operation sections (“Commands” and “ReadOut Data”) control the collection of data and configuration of the ZSC31150.

Figure 3.8 Operation Sections

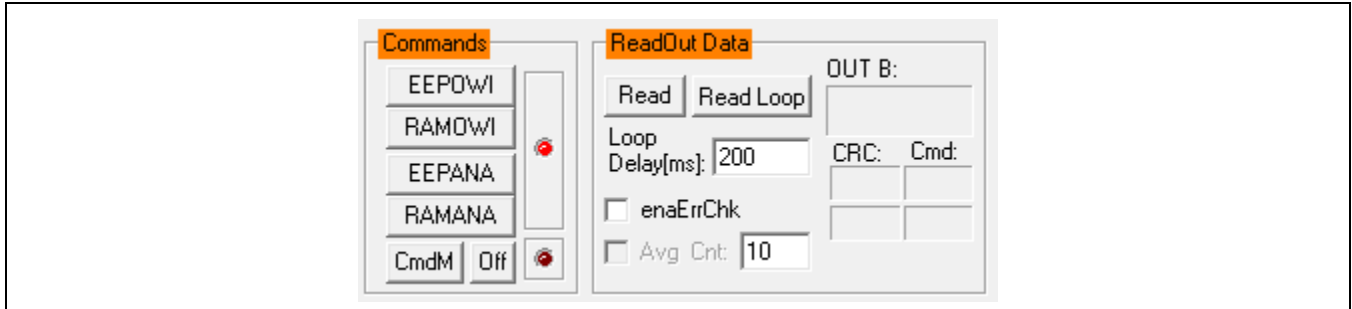

3.5.1. “Commands” Section: Normal Operation Mode (NOM)

- **EEPOWI**: Starts NOM using the EEPROM configuration with digital output only; i.e., OWI Interface Mode.
- **RAMOWI**: Starts NOM using current the RAM configuration with digital output only; i.e., OWI Interface Mode.
- **EEPANA**: Starts NOM using the EEPROM configuration with analog output; i.e., Analog Output Mode.
- **RAMANA**: Starts NOM using the current RAM configuration with analog output; i.e., Analog Output Mode.

Figure 3.9 Output Selection

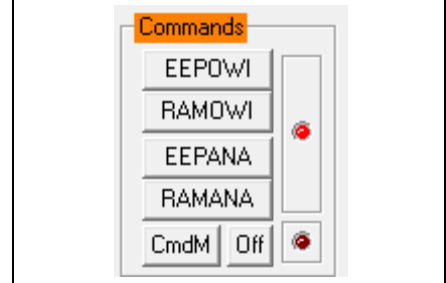

3.5.2. “Commands” Section: Command Mode (CM)

CmdM: Re-starts the Command Mode of the ZSC31150 by powering off the ZSC31150 and then sending the Start_CM command (72D1_{HEX}) again.

3.5.3. “Commands” Section: Power ZSC31150 Off

Off: Switches off all power supplies to SSC EB. Also all communication interfaces are disabled, so no further communication is possible until the **CmdM** button has been clicked or the next interface is selected.

3.5.4. Read-Out Data Section: Options for Reading Data

Read & **ReadLoop**: To start a readout of sensor data, click on one of these buttons. If a loop is started, the button text changes to “Stop.” Click again to stop the loop.

3.5.5. Read-Out Data Section: Enable Error Check

enaErrChk: Enables error checking according to the application settings described in section 3.4.6. An error message will be displayed if any of the errors selected occur.

3.5.6. Average Count and Statistics

Avg Cnt: This checkbox enables averaging and statistics calculation. It is only active if the measurement is in loop mode. The resulting data will be displayed after the specified cycles in the field have passed.

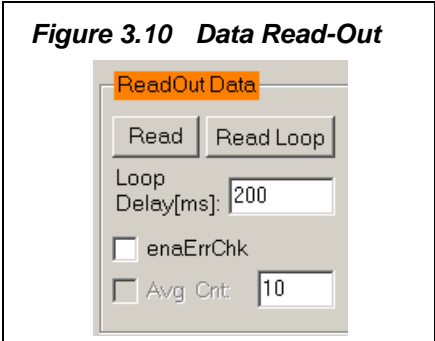

Figure 3.10 Data Read-Out

3.6. Output Configuration

The ZSC31150 provides two output options at the AOUT pin. Depending on the setting selected in the “Interface & Board Version” section (see section 3.4.1), this output is either the analog output or the digital OWI interface:

- Ratiometric analog voltage output (5 - 95% at maximum)
- ZACwire™ (OWI)

The sequence in which this pin (AOUT) is configured is set by the “OWI Mode” drop-down menu in the “Interface and Board Version” section (see Figure 3.11):

- OWIWIN: OWI interface is enabled only for a specific time window (approximately 100ms).
- OWIANA: OWI is enabled, but analog output is activated without a delay.
- OWIENA: OWI is enabled without analog output.
- OWIDIS: OWI interface is disabled with immediate analog output enabled.

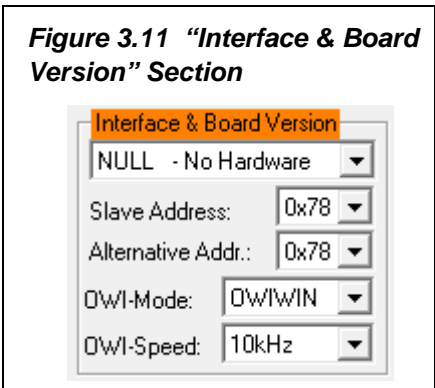

Figure 3.11 “Interface & Board Version” Section

3.7. Calibration Window



The “Sensor – Calibration” dialog is accessed by clicking on the  icon on the top banner or by clicking on “Calibration” in the top menu and again in the resulting drop-down menu. It is used to perform a calibration of the ZSC31150 with either the SRB or the user’s sensor module. Section 4 gives an example calibration using the commands on this screen.

Figure 3.12 “Sensor – Calibration” Dialog

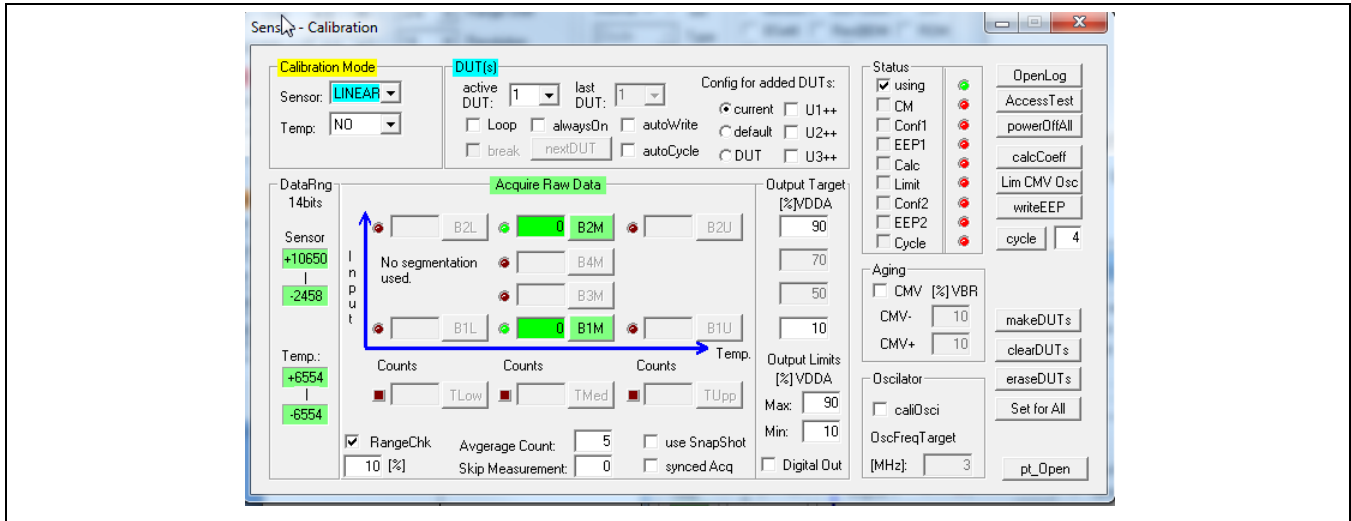

3.8. “RAM-Register” Dialog Window

The “RAM-Register” dialog is accessed by clicking on the  icon on the top banner or clicking on “Configuration” in the top menu and then on “EEPROM/RAM” in the resulting drop-down menu. It is used to read and write register contents into the ZSC31150 memories and has the same functionality as the “DUT Configuration” section in the main window.

Register indexing corresponds to the ZSC31150 memory addresses. Refer to the *ZSC31150 Functional Description* for a description of the registers. If current settings differ from the memory contents, registers that do not correspond to memory have a red background after a “Read” operation.

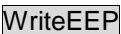
Clicking on the  button stores all register contents into the EEPROM of the ZSC31150.

The configuration of the ZSC31150 is stored in 20 EEPROM 16-bit words.

- Calibration coefficients for conditioning the sensor signal via conditioning calculations and output limits are stored in eight registers (registers 0_{HEX} to 7_{HEX}).
- Three registers are used to configure the output limits (registers 8_{HEX} and 9_{HEX}) and CMV measurement limits (register A_{HEX}).
- There are four words for setting the configuration of the ZSC31150 for the application (registers B_{HEX} to E_{HEX}, indicated by yellow background).

Figure 3.13 Displaying RAM-EEP Register Contents

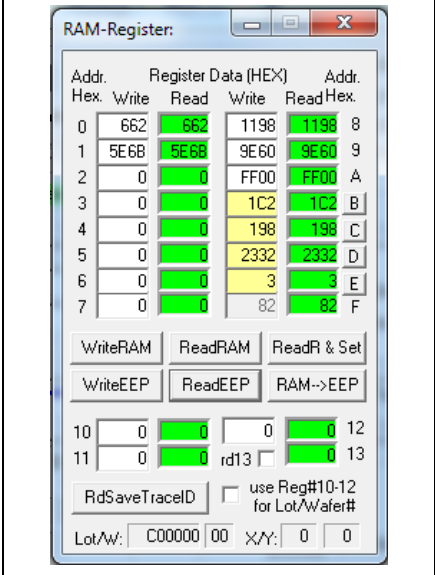

- One register is used for storing the EEPROM signature, which is used in NOM to check the validity of the EEPROM contents after power-on, (register F_{HEX}).
- Three additional 16-bit registers (registers 10_{HEX} to 12_{HEX}) are available for optional user data.

3.9. Get Raw Values Dialog

The “Get Raw Values” dialog is accessed by clicking on the  icon on the top banner or clicking on “Calibration” in the top menu and then “Get Raw Values” in the resulting drop-down menu. It is used to acquire the RAW values of the measurements for the following values.

BR: Sensor Signal Raw Data (main channel).

T: Temperature Signal Raw Data.

BRAZ: Sensor Signal Auto-Zero Raw Data.

TAZ: Temperature Signal Auto-Zero Raw Data.

SSCP: Positive-Biased Sensor Short and Connection Check Raw Data.

SSCN: Negative-Biased Sensor Short and Connection Check Data.

SSC P-N: Differential Input Raw Data.

SAC: Sensor Aging Check (Common Mode Voltage) Raw Data.

SAC_AZC: Sensor Aging Check (Common Mode Voltage) Raw Data including Auto-Zero Compensation.

BR_AZC: Sensor Signal Main Channel Raw Data including Auto-Zero Compensation.

T_AZC: Temperature Signal Raw Data including Auto-Zero Compensation

Figure 3.14 “Get Raw Values” Dialog

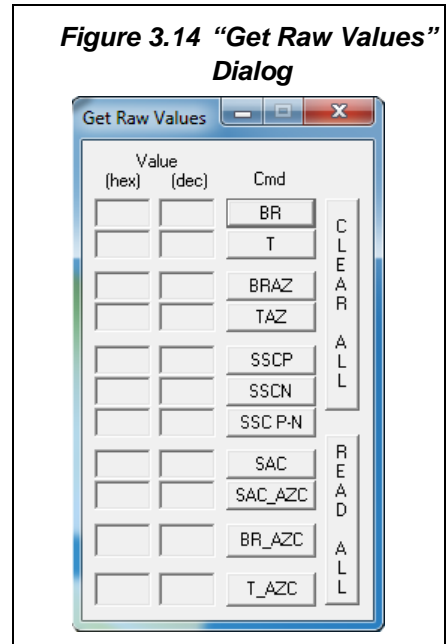

3.10. Send Command

The “Send Command” dialog is accessed by clicking on the  icon on the top banner or clicking on “Calibration” in the top menu and then “Send Command” in the resulting drop-down menu (see Figure 3.15). It is used for transferring commands from the PC to the microcontroller on the SSC CB and reading the result of the commands. A full summary and detailed command description of the applicable controller commands are given in the *SSC CB Command Syntax Spreadsheet*.

For the communication between the SSC CB and the ZSC31150, the ZSC31150’s slave address and the communication frequency can be selected from the drop-down menus in the “Send Command” dialog.

Figure 3.15 “Send Command” Dialog

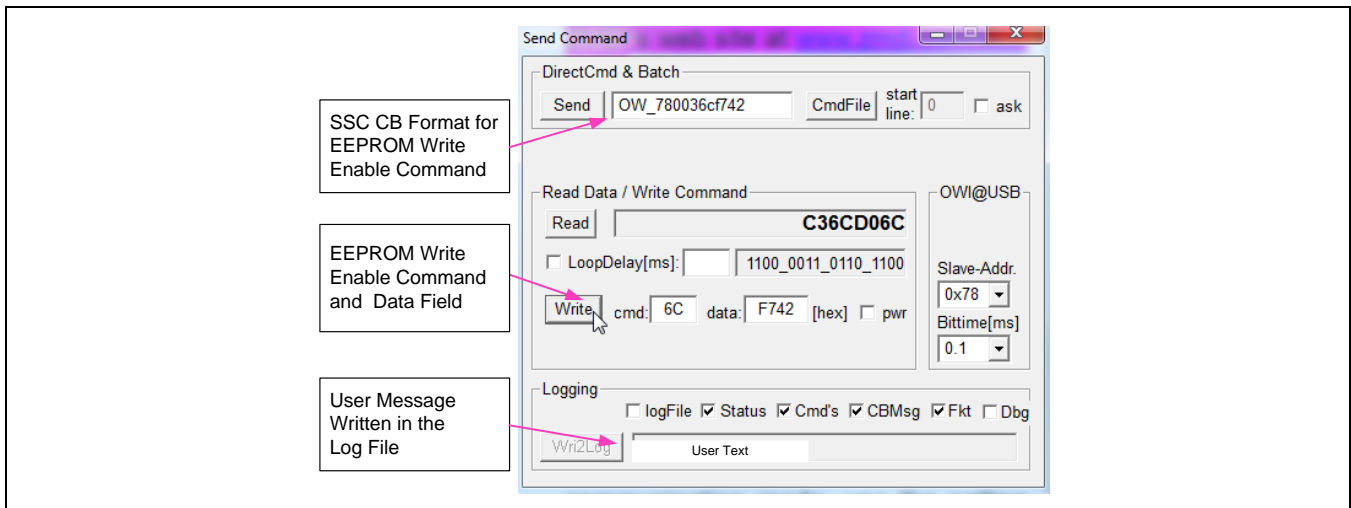

The “Send Command” dialog includes the following buttons:

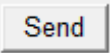
- 

Sends a command to the CB. Alternatively, a *.31150_cmd command file can be loaded.
- 

Reads the output data buffer of the ZSC31150. A loop delay can also be added between the readings.
- 

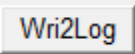
Performs the same function as the “Send” command except that the command field and the data field are separated. The ZSC31150 software generates the actual instruction to be sent to the SSC CB. The “pwr” check box, if enabled, makes it possible to power the IC on/off by sending the 72_{HEX} command.
- 

Writes text entered in the adjacent field to the log file. The checkboxes can be used to write various data into the log file, such as status, commands, messages, etc.
The logFile check box enables and disables the logging.

Note: For additional functionality, the *IDT SSC Terminal Software* can be used as an alternative to the ZSC31150 Evaluation Software. The *SSC Terminal Software* can be downloaded from IDT’s web site at www.IDT.com/ZSC31150KIT. This is the lowest level of communication for transferring commands from the PC to the microcontroller on the SSC CB. A full summary and detailed command description of the applicable controller commands are given in IDT’s spreadsheet *SSC CB Command Syntax for Version 4.x Communication Boards*, (see section 6).

Clicking on the downloaded executable file *SSC Terminal/Vxxy.exe* installs the terminal software and creates a *IDT SSC Terminal* icon on the PC desktop. Click on this icon to activate the terminal program. For the communication mode, use the setting explained for I²C™.

4 Calibration Demonstration

The following directions perform an example of a simple demonstration calibration using the sensor replacement board (SRB) to replicate the resistance change of a basic sensor responding to a measurand. The calibrated output will be displayed as a calibration result by the software.

4.1. Hardware Setup

The steps for the calibration procedure are as follows:

- a) Connect the SSC CB, SSC EB, and the SRB as shown in Figure 4.1.
- b) Insert the ZSC31150 into the socket (note pin 1 orientation). Press down on top of the socket in order to open the connector.
- c) Connect a USB cable from the USB connector on the SSC CB to an available USB port on the PC. Verify that the green PWR LED is lit on the SSC CB.

Figure 4.1 Inserting the ZSC31150 into the Socket

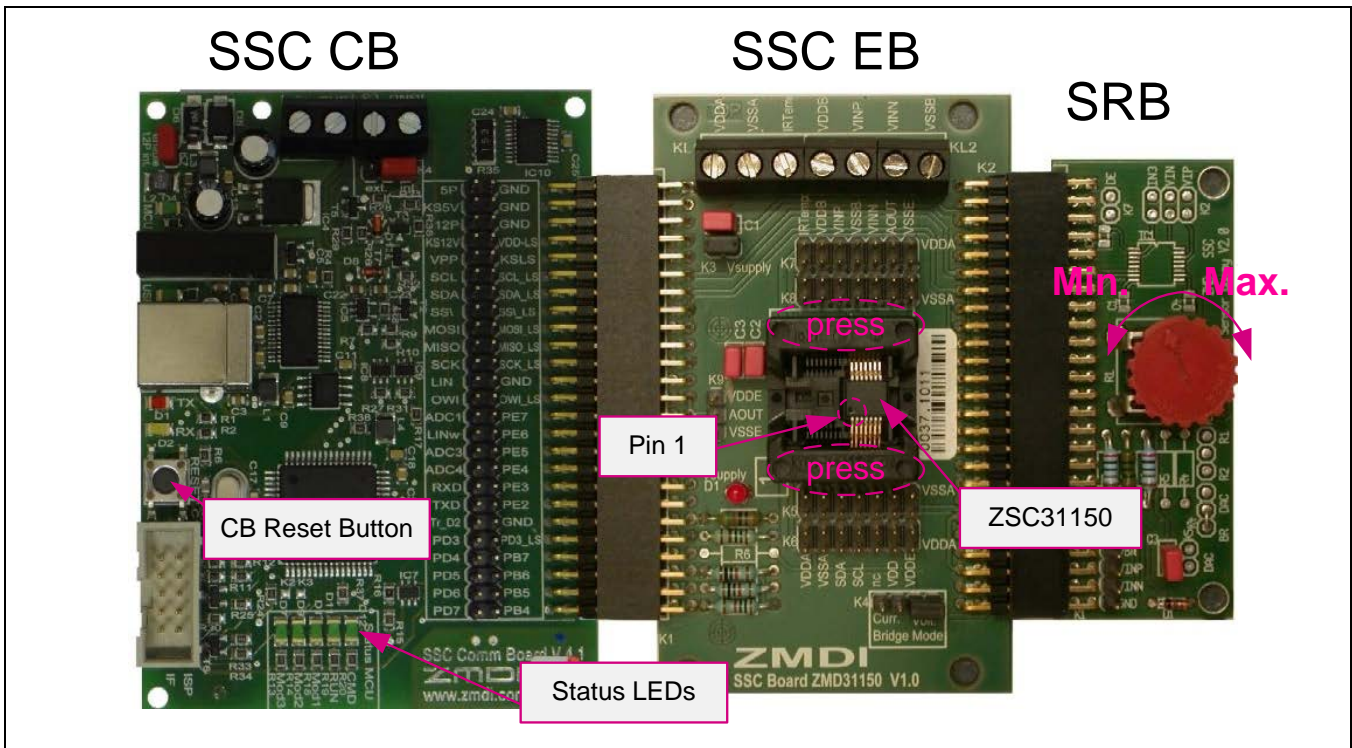

4.2. Software Startup

- Start the ZSC31150 Software by clicking on the desktop icon  or from the Windows® start menu folder: ... \ZMDI\ZSC31150\ZSC31150.EXE.
- Select “I2C USB kit” or “OWI USB kit” from the drop-down menu in the “Interface & Board Version” section of the main window.
- Select the following AFE settings:
 - 32mV/V** span (sensor sensitivity), which is the typical span when using the SRB; for the 5V supply, this equals a total of 160mV.
 - 14** bits of resolution; i.e., 16384 steps of the ADC.
 - ¾** range shift, which fits the input signal range to the ADC output value (“analog zero”). For example for a range shift of ¾ and 14 bits resolution, the read-out values would be between -4096 and +12287.
- Important: Write the configuration into the RAM by clicking on the **WriteRAM** button in the “DUT Configuration” section.

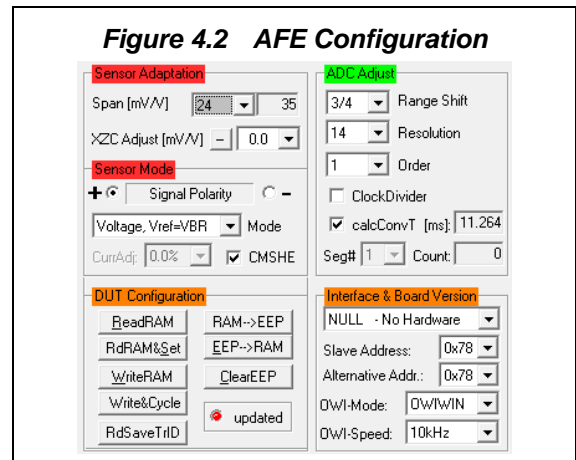

4.3. Calibration Data Acquisition

- Click on the  icon or select “Calibration” -> “Calibration” from the menu. The “Sensor-Calibration” window appears (see Figure 4.3 and Figure 3.11).
- Select the calibration mode from the drop-down menus in the “Calibration Mode” section. For this example, the recommended mode is the following combination:
 - ✓ **LINEAR** (two points only) for the sensor
 - ✓ **NO** calibration for the temperature (temperature calibration requires a chamber with controlled environment).
- Type the desired sensor target corresponding in percent to the VDD supply in the “Output Target [%]VDDA” section. It is recommended that the output targets for the sensor points be between 10% and 90%.
- Next start data collection. Normally this would be done with an actual sensor attached on a remote board in a controlled chamber. Instead, this example calibration run uses the SRB as the input as follows:
 - ✓ **Minimum [10%] sensor signal:** Turn the potentiometer on the SRB counter-clockwise (CCW) to the end and click the **B1M** button.
 - ✓ **Maximum [90%] sensor signal:** Turn the potentiometer clockwise (CW) to the end and click the **B2M** button.

Note: Acquired data will be displayed in the text boxes next to the buttons. A green background means the data is within the range check limits (typical 10% to 90% of the ADC range). A purple background means that the acquired raw data has not been checked against any limits and if ADC saturation occurs, it will not trigger a warning. A red background means that acquired data fails the range check limits.

Figure 4.3 Calibration Results

Note: Only active buttons corresponding to the calibration mode are light green.

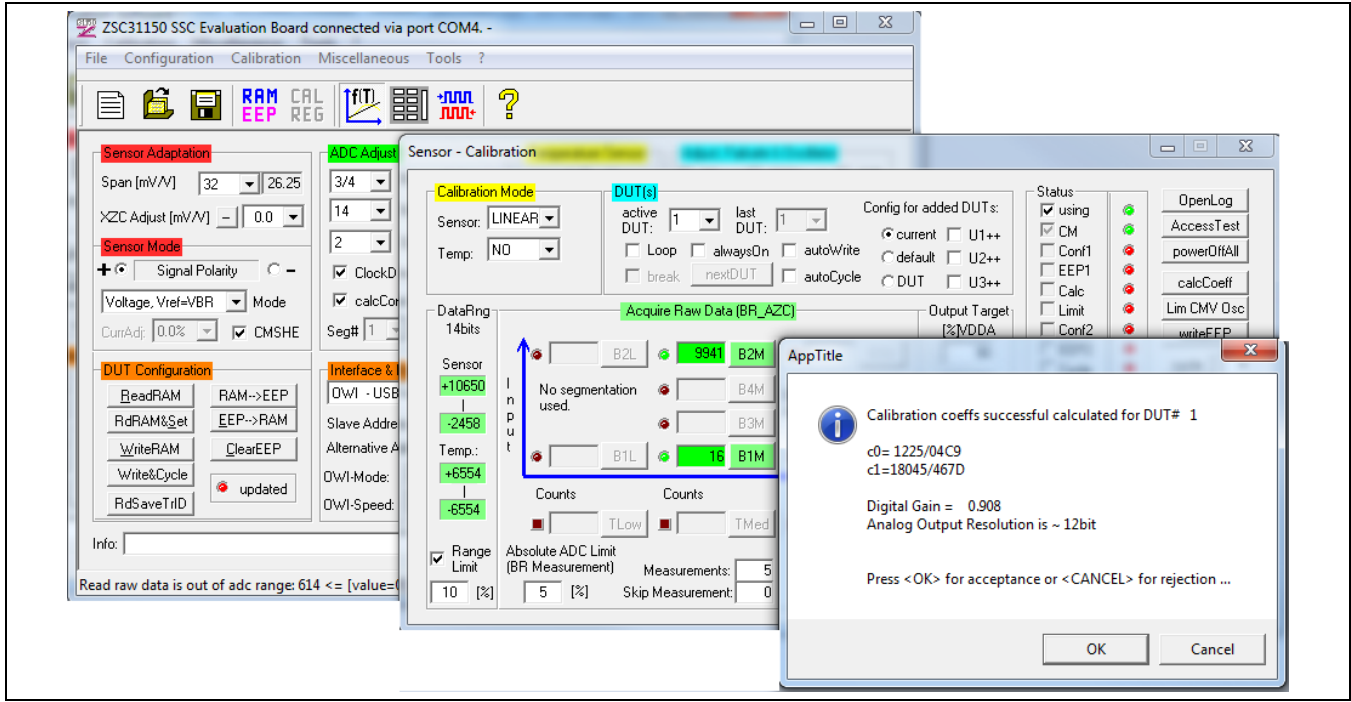

4.4. Calculation of the Coefficients and Limits

Note: All active buttons corresponding to the calibration method selected are green.

- a) **calcCoeff** button at the right of the “Sensor – Calibration” screen calculates the calibration coefficients. The result of the calculation (if successful) is displayed on the screen. The CMC removes the offset and temperature dependency so that the measured output result would be within the target values (%VDDA or in this case in between 10% and 90%).

Note: The number of calibration points is equal to the number of coefficients to be calculated.

- b) **Lim CMV Osc** button calculates sensor aging (CMV) and oscillator limits.
- c) **writeEEP** button makes these calculations effective and writes them in the EEPROM. Option: A measuring cycle can be triggered by clicking the **cycle** button.

Close the calibration window and trigger a measurement in the main window by clicking on either the **Read** or **ReadLoop** button in the “ReadOut Data” section. The ZSC31150 is already running in Normal Operation Mode (NOM) if the **cycle** button was clicked in the calibration window.

Measurement results can also be displayed in % in the “Measure” window by clicking “Tools” on the top menu and then “Measure Output” in the drop-down menu. Select the output format in the checkbox.

5 Ordering Information

Product Sales Code	Description
ZSC31150KITV1.1	ZSC31150 Evaluation Kit, version 1.1
SSC Comm. Board V4.1	SSC Communication Board (SSC CB) V4.1 (including USB cable) *
SSC Board ZSC31150 V1.0	ZSC31150 SSC Evaluation Board (SSC EB) V1.0 *
SSC Sensor Replacement Board V2.0	SSC Sensor Replacement Board (SRB) V2.0 *
SSC Test Board V1.0	SSC Test Board V1.0*

* Can be ordered separately after ordering the ZSC31150 Evaluation Kit.

6 Related Documents

Document
ZSC31150 Data Sheet
ZSC31150 Functional Description
SSC Communication Board Data Sheet *
SSC Sensor Replacement Board Data Sheet *
SSC Application Note—Communication Board Driver Installation *
For SSC Command Boards V3.x only.
SSC CB Command Syntax Spreadsheet for Version 4.x Communication Boards *
For SSC Command Boards V4.x only.
SSC CB Command Syntax Spreadsheet for Version 3.x Communication Boards *
For SSC Command Boards V3.x only.

Visit the ZSC31150 product page (www.IDT.com/ZSC31150) or contact your nearest sales office for the latest version of these documents.

* Documents marked with an asterisk (*) can be found on at www.IDT.com/SSC-COMM-BD.

7 Glossary

Term	Description
ADC	Analog-to-Digital Converter
AFE	Analog Front End
CB	Communication Board
CMC	Calibration Microcontroller
CMV	Common Mode Voltage
OWI	One-Wire Interface
PCB	Printed Circuit Board
PGA	Programmable Gain Amplifier
SRB	Sensor Replacement Board
SSC	Sensor Signal Conditioner <i>or</i> Sensor Short Check <i>depending on context</i>
μ C	Microcontroller

8 Document Revision History

Revision	Date	Description
1.00	February 28, 2012	First release.
2.00	October 7, 2014	Updates for all documentation and software being available on the www.zmdi.com . Updates for new version software. Updates for related documents. Updates for cover imagery and contact information.
2.01	February 3, 2015	Main screen illustration updated for new revision of software. Added reference to the Command Syntax document. Update for contact information and minor edits for clarity.
2.02	November 2, 2015	Update for new version of software, including removal of references to the PGAHigh and PGALow buttons. Updates for related documents.
	May 3, 2016	Changed to IDT branding.

Notice

1. Descriptions of circuits, software and other related information in this document are provided only to illustrate the operation of semiconductor products and application examples. You are fully responsible for the incorporation or any other use of the circuits, software, and information in the design of your product or system. Renesas Electronics disclaims any and all liability for any losses and damages incurred by you or third parties arising from the use of these circuits, software, or information.
2. Renesas Electronics hereby expressly disclaims any warranties against and liability for infringement or any other claims involving patents, copyrights, or other intellectual property rights of third parties, by or arising from the use of Renesas Electronics products or technical information described in this document, including but not limited to, the product data, drawings, charts, programs, algorithms, and application examples.
3. No license, express, implied or otherwise, is granted hereby under any patents, copyrights or other intellectual property rights of Renesas Electronics or others.
4. You shall be responsible for determining what licenses are required from any third parties, and obtaining such licenses for the lawful import, export, manufacture, sales, utilization, distribution or other disposal of any products incorporating Renesas Electronics products, if required.
5. You shall not alter, modify, copy, or reverse engineer any Renesas Electronics product, whether in whole or in part. Renesas Electronics disclaims any and all liability for any losses or damages incurred by you or third parties arising from such alteration, modification, copying or reverse engineering.
6. Renesas Electronics products are classified according to the following two quality grades: "Standard" and "High Quality". The intended applications for each Renesas Electronics product depends on the product's quality grade, as indicated below.

"Standard": Computers; office equipment; communications equipment; test and measurement equipment; audio and visual equipment; home electronic appliances; machine tools; personal electronic equipment; industrial robots; etc.

"High Quality": Transportation equipment (automobiles, trains, ships, etc.); traffic control (traffic lights); large-scale communication equipment; key financial terminal systems; safety control equipment; etc.

Unless expressly designated as a high reliability product or a product for harsh environments in a Renesas Electronics data sheet or other Renesas Electronics document, Renesas Electronics products are not intended or authorized for use in products or systems that may pose a direct threat to human life or bodily injury (artificial life support devices or systems; surgical implantations; etc.), or may cause serious property damage (space system; undersea repeaters; nuclear power control systems; aircraft control systems; key plant systems; military equipment; etc.). Renesas Electronics disclaims any and all liability for any damages or losses incurred by you or any third parties arising from the use of any Renesas Electronics product that is inconsistent with any Renesas Electronics data sheet, user's manual or other Renesas Electronics document.
7. No semiconductor product is absolutely secure. Notwithstanding any security measures or features that may be implemented in Renesas Electronics hardware or software products, Renesas Electronics shall have absolutely no liability arising out of any vulnerability or security breach, including but not limited to any unauthorized access to or use of a Renesas Electronics product or a system that uses a Renesas Electronics product. RENESAS ELECTRONICS DOES NOT WARRANT OR GUARANTEE THAT RENESAS ELECTRONICS PRODUCTS, OR ANY SYSTEMS CREATED USING RENESAS ELECTRONICS PRODUCTS WILL BE INVULNERABLE OR FREE FROM CORRUPTION, ATTACK, VIRUSES, INTERFERENCE, HACKING, DATA LOSS OR THEFT, OR OTHER SECURITY INTRUSION ("Vulnerability Issues"). RENESAS ELECTRONICS DISCLAIMS ANY AND ALL RESPONSIBILITY OR LIABILITY ARISING FROM OR RELATED TO ANY VULNERABILITY ISSUES. FURTHERMORE, TO THE EXTENT PERMITTED BY APPLICABLE LAW, RENESAS ELECTRONICS DISCLAIMS ANY AND ALL WARRANTIES, EXPRESS OR IMPLIED, WITH RESPECT TO THIS DOCUMENT AND ANY RELATED OR ACCOMPANYING SOFTWARE OR HARDWARE, INCLUDING BUT NOT LIMITED TO THE IMPLIED WARRANTIES OF MERCHANTABILITY, OR FITNESS FOR A PARTICULAR PURPOSE.
8. When using Renesas Electronics products, refer to the latest product information (data sheets, user's manuals, application notes, "General Notes for Handling and Using Semiconductor Devices" in the reliability handbook, etc.), and ensure that usage conditions are within the ranges specified by Renesas Electronics with respect to maximum ratings, operating power supply voltage range, heat dissipation characteristics, installation, etc. Renesas Electronics disclaims any and all liability for any malfunctions, failure or accident arising out of the use of Renesas Electronics products outside of such specified ranges.
9. Although Renesas Electronics endeavors to improve the quality and reliability of Renesas Electronics products, semiconductor products have specific characteristics, such as the occurrence of failure at a certain rate and malfunctions under certain use conditions. Unless designated as a high reliability product or a product for harsh environments in a Renesas Electronics data sheet or other Renesas Electronics document, Renesas Electronics products are not subject to radiation resistance design. You are responsible for implementing safety measures to guard against the possibility of bodily injury, injury or damage caused by fire, and/or danger to the public in the event of a failure or malfunction of Renesas Electronics products, such as safety design for hardware and software, including but not limited to redundancy, fire control and malfunction prevention, appropriate treatment for aging degradation or any other appropriate measures. Because the evaluation of microcomputer software alone is very difficult and impractical, you are responsible for evaluating the safety of the final products or systems manufactured by you.
10. Please contact a Renesas Electronics sales office for details as to environmental matters such as the environmental compatibility of each Renesas Electronics product. You are responsible for carefully and sufficiently investigating applicable laws and regulations that regulate the inclusion or use of controlled substances, including without limitation, the EU RoHS Directive, and using Renesas Electronics products in compliance with all these applicable laws and regulations. Renesas Electronics disclaims any and all liability for damages or losses occurring as a result of your noncompliance with applicable laws and regulations.
11. Renesas Electronics products and technologies shall not be used for or incorporated into any products or systems whose manufacture, use, or sale is prohibited under any applicable domestic or foreign laws or regulations. You shall comply with any applicable export control laws and regulations promulgated and administered by the governments of any countries asserting jurisdiction over the parties or transactions.
12. It is the responsibility of the buyer or distributor of Renesas Electronics products, or any other party who distributes, disposes of, or otherwise sells or transfers the product to a third party, to notify such third party in advance of the contents and conditions set forth in this document.
13. This document shall not be reprinted, reproduced or duplicated in any form, in whole or in part, without prior written consent of Renesas Electronics.
14. Please contact a Renesas Electronics sales office if you have any questions regarding the information contained in this document or Renesas Electronics products.

(Note1) "Renesas Electronics" as used in this document means Renesas Electronics Corporation and also includes its directly or indirectly controlled subsidiaries.

(Note2) "Renesas Electronics product(s)" means any product developed or manufactured by or for Renesas Electronics.

(Disclaimer Rev.5.0-1 October 2020)

Corporate Headquarters

TOYOSU FORESIA, 3-2-24 Toyosu,
Koto-ku, Tokyo 135-0061, Japan
www.renesas.com

Trademarks

Renesas and the Renesas logo are trademarks of Renesas Electronics Corporation. All trademarks and registered trademarks are the property of their respective owners.

Contact Information

For further information on a product, technology, the most up-to-date version of a document, or your nearest sales office, please visit:
www.renesas.com/contact/