

ZSSC3240

Cyclic Mode and Sequencer Operation

This document describes the Cyclic Mode and the Sequencer operation and relevant set up procedures through EVK GUI for the ZSSC3240 resistive sensor conditioner.

It is highly recommended to read the following documents before using this manual:

- ZSSC3240 Datasheet: [ZSSC3240 - High-End 24-Bit Sensor Signal Conditioner with Analog and Digital Output | Renesas.](#)
- ZSSC3240 SSC Evaluation Kit User Manual: [ZSSC3240 - High-End 24-Bit Sensor Signal Conditioner with Analog and Digital Output | Renesas.](#)
- SSC Communication board - SSCCOMMBOARDV4P1C: [SSC Communication Board.](#)

Contents

1. User Computer Requirements and Setup	3
1.1 Computer Requirements.....	3
1.2 Evaluation Software Installation and Setup	3
2. Hardware Requirements and Setup	3
2.1 Boards	3
2.2 Evaluation Board Jumpers Setup.....	4
2.3 Overall System Assembly	4
3. Cyclic Mode.....	5
3.1 Setup	5
3.2 Exit.....	6
3.3 EOC Signal	6
3.4 Measurement Time Slot.....	7
3.5 Analog Output Settings.....	8
4. Scheduler GUI Control.....	8
5. Scheduler Operation	9
5.1 Scheduler without Configured Measurements	9
5.2 Scheduler with Activated SM	10
5.3 Scheduler with AZSM + SM.....	11
5.4 Scheduler with External AZTM + TM.....	11
5.5 Scheduler with AZSM, SM, AZTM and TM.....	12
5.6 Sensor Connection Check	13
5.7 Update Rate	14
6. Scheduler Operation Examples.....	15
6.1 Example 1	15
6.2 Example 2.....	16
6.3 Example 3.....	18
7. Glossary	19
8. Revision History.....	19

Figures

Figure 1. EVB Jumper Settings	4
Figure 2. Overall System.....	4
Figure 3. Mode Setting.....	5
Figure 4. Cyclic Mode at Start Up.....	6
Figure 5. Entering Command Mode.....	6
Figure 6. EOC and AOUT Signal.....	7
Figure 7. AAHEX Command for Full Measurement Sequence	7
Figure 8. AOUT Data Selection.....	8
Figure 9. Scheduler for Cyclic Operation	8
Figure 10. Cyclic Mode and AZs on the NVM Tab of the GUI	8
Figure 11. Scheduler Settings no Measurements	9
Figure 12. EOC Pin Output, no Measurements.....	9
Figure 13. Scheduler Settings SM.....	10
Figure 14. EOC Pin Output, SM	10
Figure 15. Scheduler Settings AZSM + SM	11
Figure 16. EOC Pin AZSM + SM.....	11
Figure 17. Scheduler Settings AZSM + SM + AZTM + TM.....	12
Figure 18. EOC Pin AZSM + SM + AZTM + TM.....	12
Figure 19. Summary of Measured EOC Timings	13
Figure 20. Scheduler Settings SC Check and Checks Selection.....	13
Figure 21. Update Rate Setting.....	14
Figure 22. 1ms Update Rate Delay	14
Figure 23. Measurements Slots with 1ms Delay	14
Figure 24. Example 1 Sequence	15
Figure 25. Example 1 GUI Settings	15
Figure 26. Example 1 Slot Timings.....	16
Figure 27. Example 2 Sequence	16
Figure 28. Example 2 GUI Settings	17
Figure 29. Example 2 Slot Timings.....	17
Figure 30. Example 3 Sequence	18
Figure 31. Example 3 GUI Settings	18
Figure 32. Example 3 Slot Timings.....	18

1. User Computer Requirements and Setup

A Windows®-based computer is required for interfacing with the Evaluation Kit and configuring the ZSSC3240.

1.1 Computer Requirements

Note: The user must have administrative rights on the computer to download and install the ZSSC3240 Evaluation Software for the kit.

The computer must meet the following requirements:

- Windows® 7, 8, 8.1, 10
- Microsoft® .NET Framework 4.0 or higher
- Supported architecture: x86 and x64
- USB port
- Internet access to download the install setup

1.2 Evaluation Software Installation and Setup

The latest version of ZSSC3240 Evaluation Software, which is required for the kit, must be downloaded from the Renesas web site at [ZSSC3240 - High-End 24-Bit Sensor Signal Conditioner with Analog and Digital Output | Renesas](#). The Evaluation Software and all drivers, libraries are transferred within a single exe-file.

Note: FTDI USB drivers are needed only for backwards compatibility with older Renesas communication hardware. If these drivers are not already installed on the user's computer, the software automatically installs the correct drivers after user confirmation.

Follow these procedures to install the Evaluation Kit Software on the user's computer:

1. Downloading and extract the contents of the zip file to the user's computer.
2. Start the *ZSSC324X_Evaluation_SW_vX.XX.exe* file, the 'X.XX' marks the revision number.
Note: running the file could take considerable time, the process could be additionally slowed down by an anti-virus software.

2. Hardware Requirements and Setup

2.1 Boards

The following boards are needed:

- SSC Communication Board: SSCCOMMBOARDV4P1C
- ZSSC3240 Evaluation Board: ZSSC3240EVB

2.2 Evaluation Board Jumpers Setup

Remove all jumpers and ensure that J21, J22 (SPI side), J12 (5V side) are in place as per Figure 1.

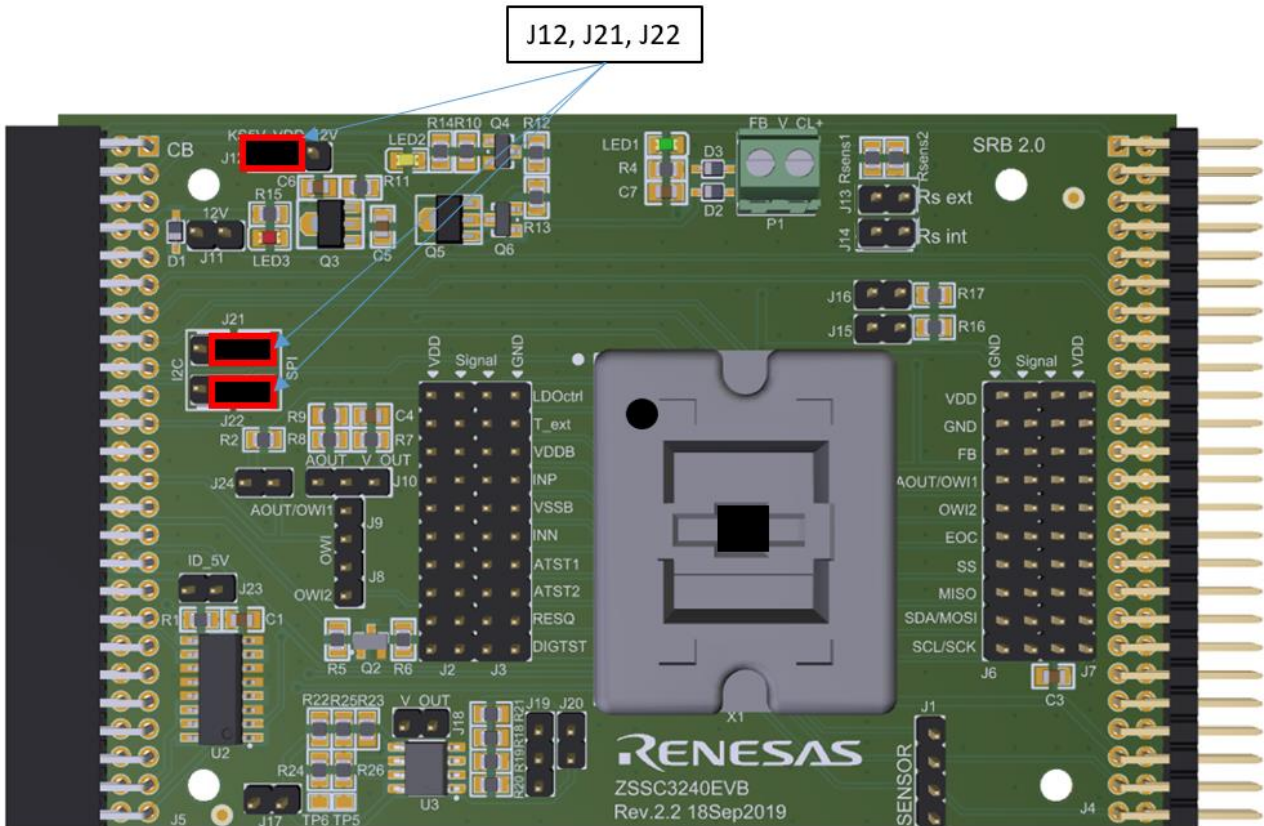

Figure 1. EVB Jumper Settings

2.3 Overall System Assembly

Connect the Communication Board to the ZSSC3240EVB through the dedicated connector, and attach the Communication Board to the host PC via a USB cable (see Figure 2).

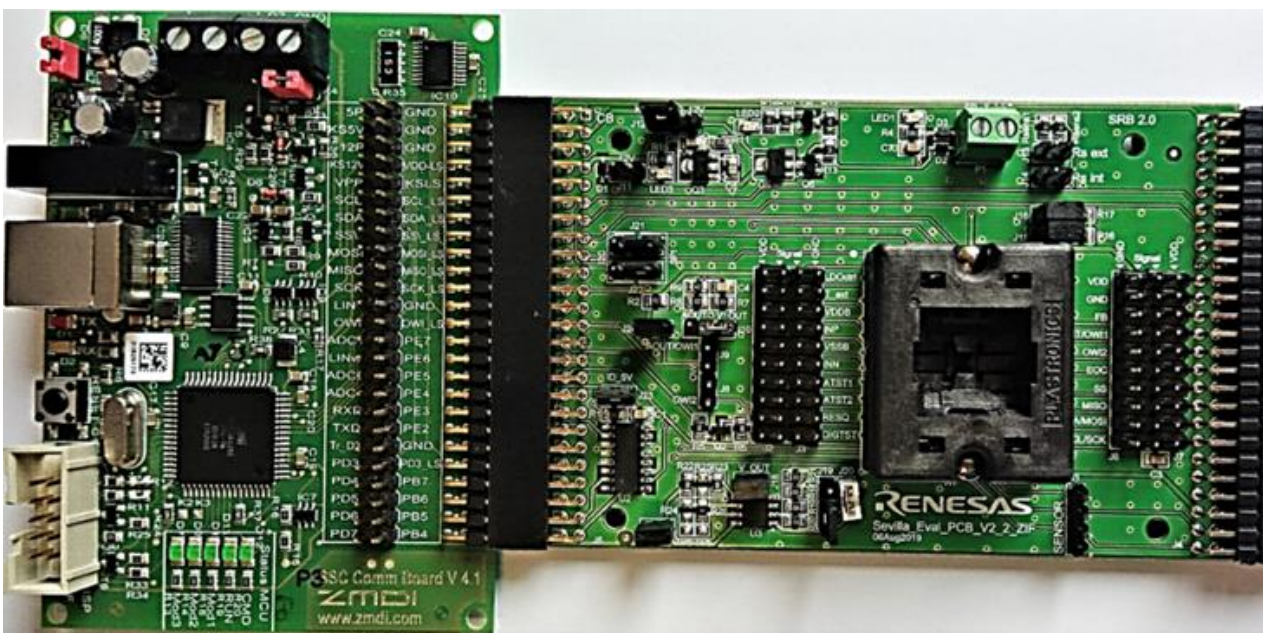

Figure 2. Overall System

3. Cyclic Mode

Single measurements requests to the ZSSC3240 (for example, the *AAHex* command) trigger the following sequence of basic measurements:

1. auto-zero-sensor measurement
2. sensor measurement
3. an auto-zero-temperature measurement and a temperature measurement
4. post acquisition correction
5. measurements are available to the user

For the complete list of commands for single measurements requests, refer to the *ZSSC3240 Datasheet* document. The ZSSC3240 can be configured for cyclic measurements, such that the host microcontroller is relieved to issue single measurement requests when the signal conditioner is configured with analog output.

3.1 Setup

ZSSC3240 powers up in Cyclic Mode if the *Default Mode* dropdown is set to Cyclic Mode on the *NVM* tab of the Main page of the GUI, see Figure 3.

Note: NVM has to be saved (by the Write NVM button) and reset before the IC powers up in Cyclic Mode, see Figure 4.

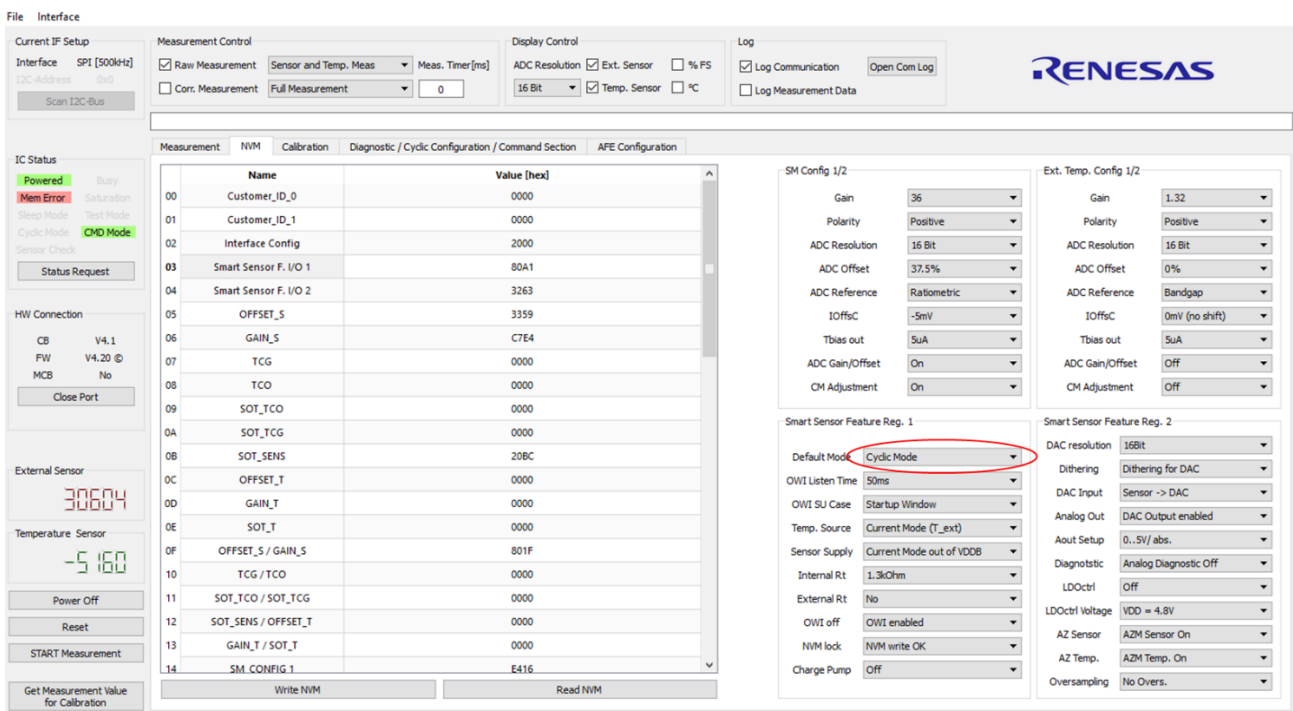

Figure 3. Mode Setting

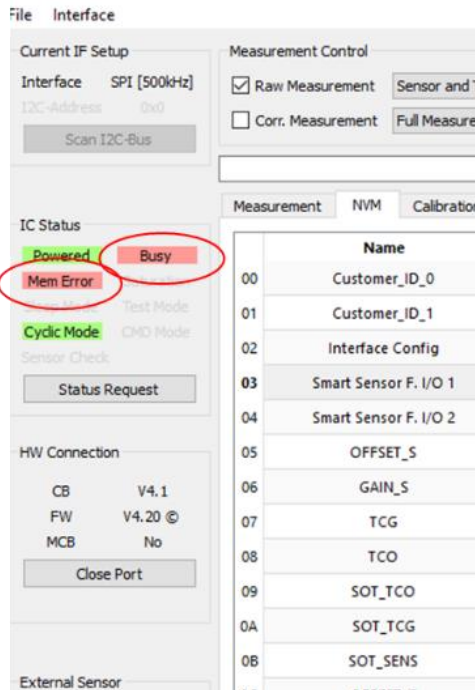

Figure 4. Cyclic Mode at Start Up

3.2 Exit

In Cyclic Mode the IC status is Busy, signifying that the ZSSC3240 is continuously measuring and converting the sensed signals. To exit Cyclic Mode click the 'Start Command Mode' button (see Figure 5) and enter the next user command.

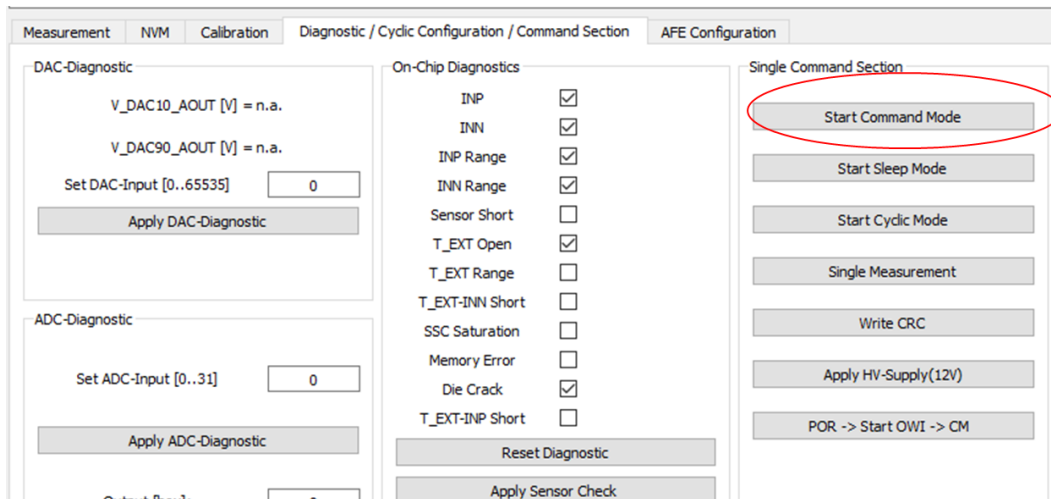

Figure 5. Entering Command Mode

3.3 EOC Signal

The output is provided at the AOUT pin (analog output) in Cyclic Mode. If the analog output is not activated in the device configuration, the microcontroller can monitor the EOC pin for updated data. The EOC signal is a pulse signaling the effective end of conversion, i.e. the availability of the corrected measurement from the SSC calculation unit. With the default configuration (register 02_{HEX} -> INT_setup = 00_{BIN}) the End of Conversion pulse is indicating that a new measurement result is available in the output registers. It could be fetched by a reading sequence of the configured digital interface (SPI, I2C, OWI).

Figure 6 displays the EOC signal on the CH1 track and the AOUT level (0-5V range) on the CH2 track when the bridge provides an input signal that is converted to 2V66 output. The cycle is composed by AZSM, SM, AZTM and TM.

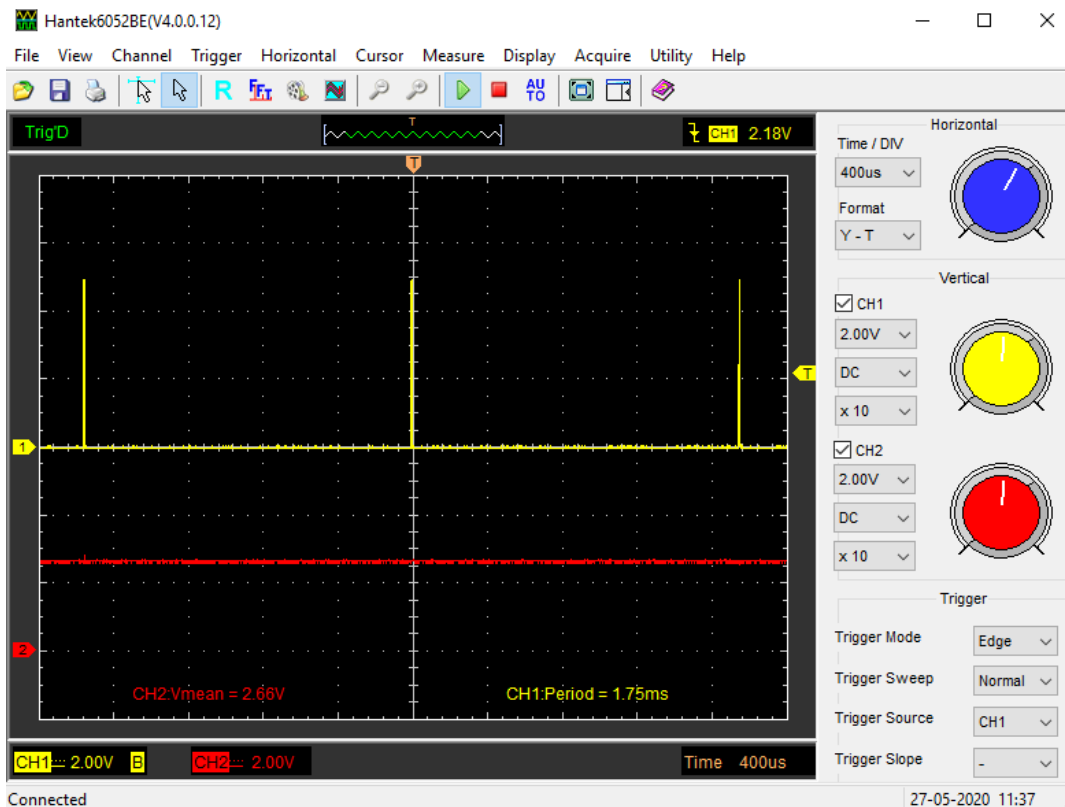

Figure 6. EOC and AOUT Signal

The end of conversion signal is issued after the AAHex command is received and the full sequence of AZSM, SM, AZTM and TM (including the correction calculation) is executed. Figure 7 shows the sequence of event started by the AAHex command.

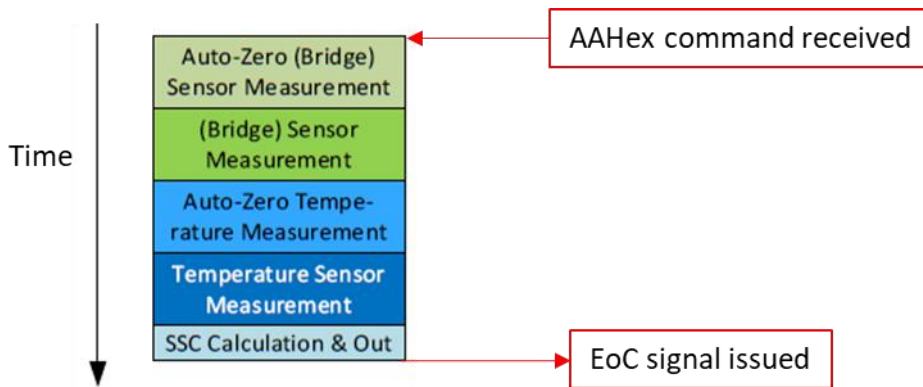

Figure 7. AAHEX Command for Full Measurement Sequence

The configurations analyzed in section 5 show how the EOC signal is issued in complex measurements schemes defined by the scheduler.

3.4 Measurement Time Slot

A measurement time slot denotes the time needed to complete a predefined set of measurements and update the ZSSC3240 output. Pauses between the slots must be defined by the update period (CYC_period). The first slot in a predefined sequence is defined as slot 0.

3.5 Analog Output Settings

Figure 8 shows the GUI options configuration to select the desired sensor data at the AOUT pin (sensor or temperature measurements).

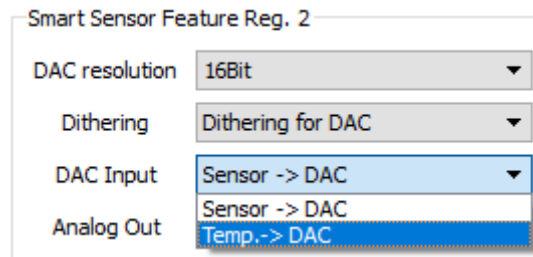

Figure 8. AOUT Data Selection

4. Scheduler GUI Control

Follow these steps to configure the measurement scheduler on the GUI (Diagnostic Tab):

1. Set the Cyclic Operation Sequence according to Figure 9 and save the configuration clicking the “Write to NVM” button.

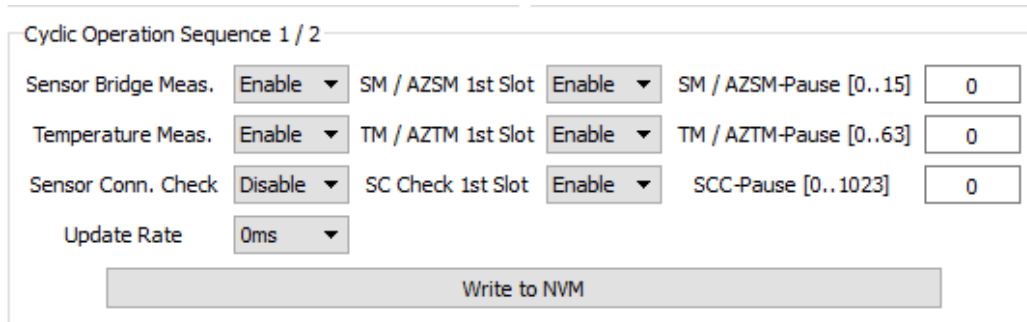

Figure 9. Scheduler for Cyclic Operation

2. Set the smart sensors according to Figure 10 to use Cyclic Mode and the Auto-Zero measurements.

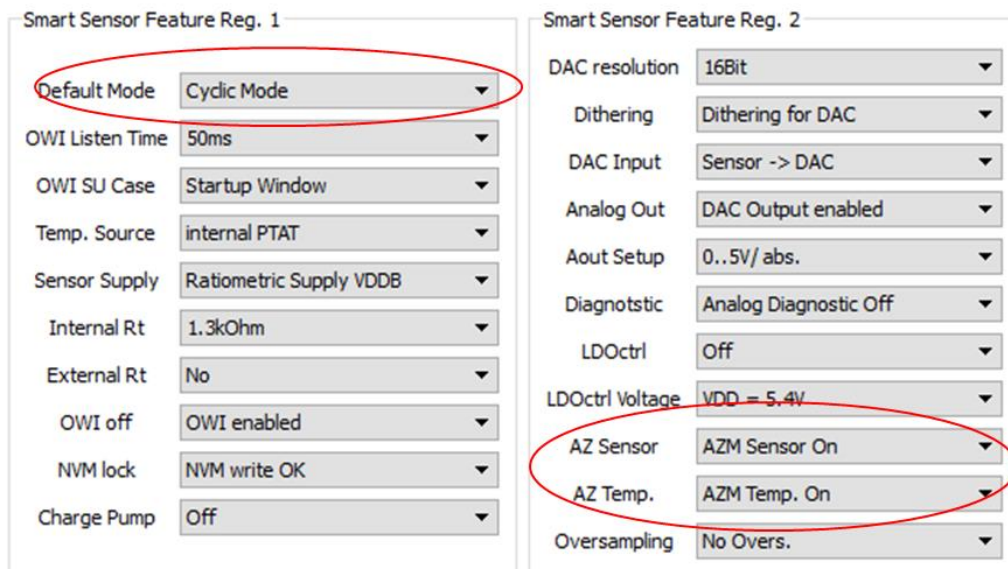

Figure 10. Cyclic Mode and AZs on the NVM Tab of the GUI

The displayed typical timing diagrams depend on the used device configuration, such as the ADC resolution (see Figure 4).

5. Scheduler Operation

The scheduler operation can be analyzed by probing the EOC signal. In the scope plots displayed in section 5 and 6, the channel CH1 is monitoring the EOC pin. The channel CH2 is generally used to monitor the AOUT pin and the analog output presence (Sensor or Temperature) with no specific goal of relating it with the input signal. Numbers shown in this section represent typical values for the relevant configurations.

5.1 Scheduler without Configured Measurements

The first scheduler configuration analyzed is with no measurements active as per Figure 11.

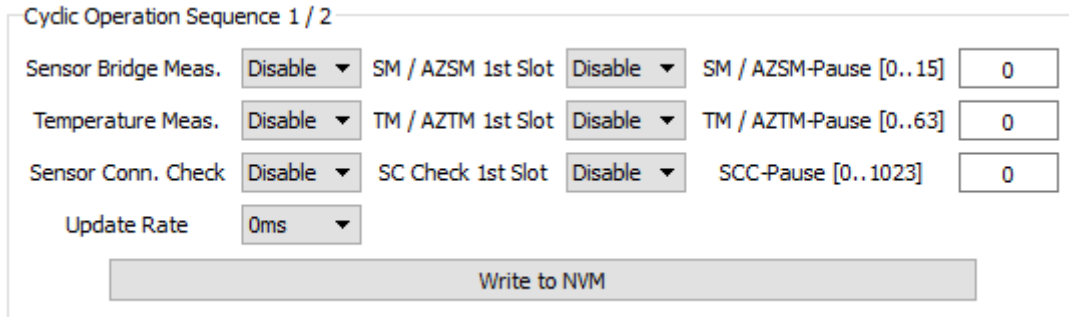

Figure 11. Scheduler Settings no Measurements

The scope plot shows the EOC signal behavior, see Figure 12.

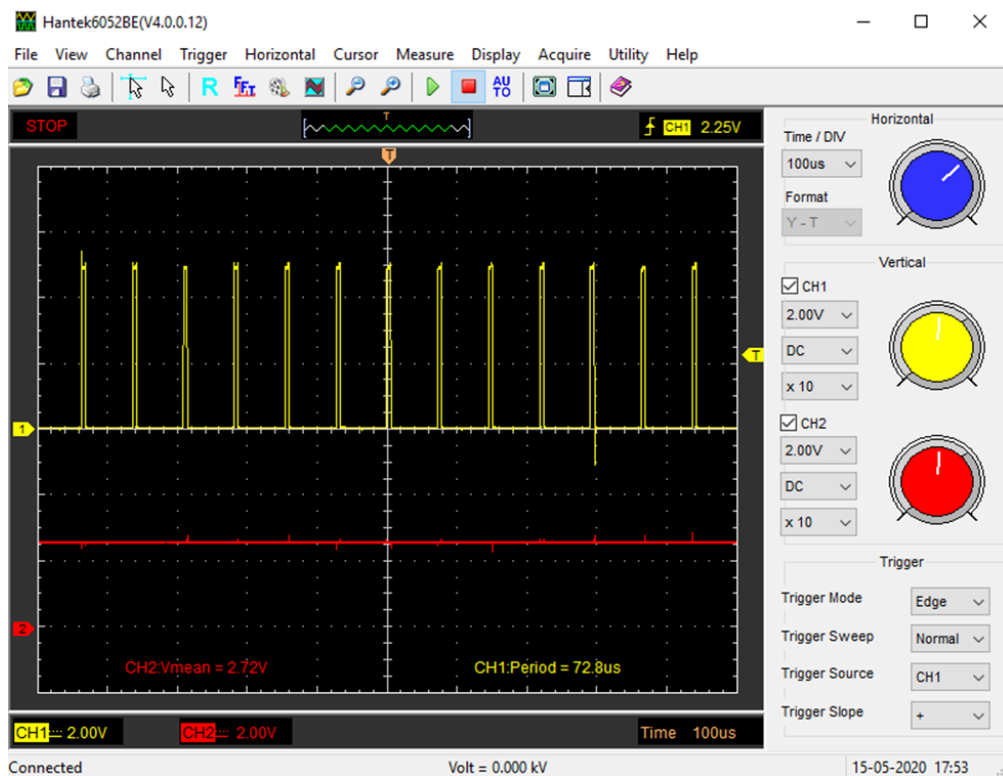

Figure 12. EOC Pin Output, no Measurements

A fixed interval between two adjacent time slots is present amounting to about 73μs. Since no measurements are configured for any time slot (not reasonable in practice), the time between the pulses is due to the processing duration performed by digital math core block, which is always active.

5.2 Scheduler with Activated SM

To enable the output at AOUT of the signal measurement, the settings are shown in Figure 13. Monitoring the EOC shows the timing in Figure 14.

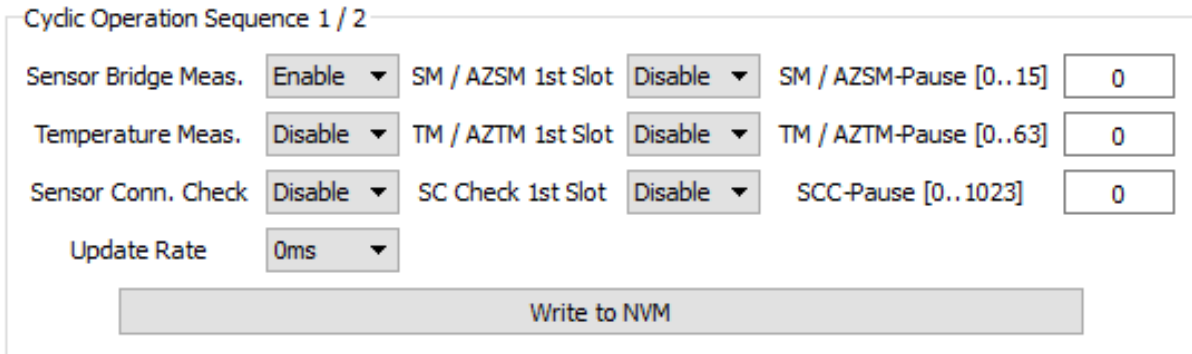

Figure 13. Scheduler Settings SM

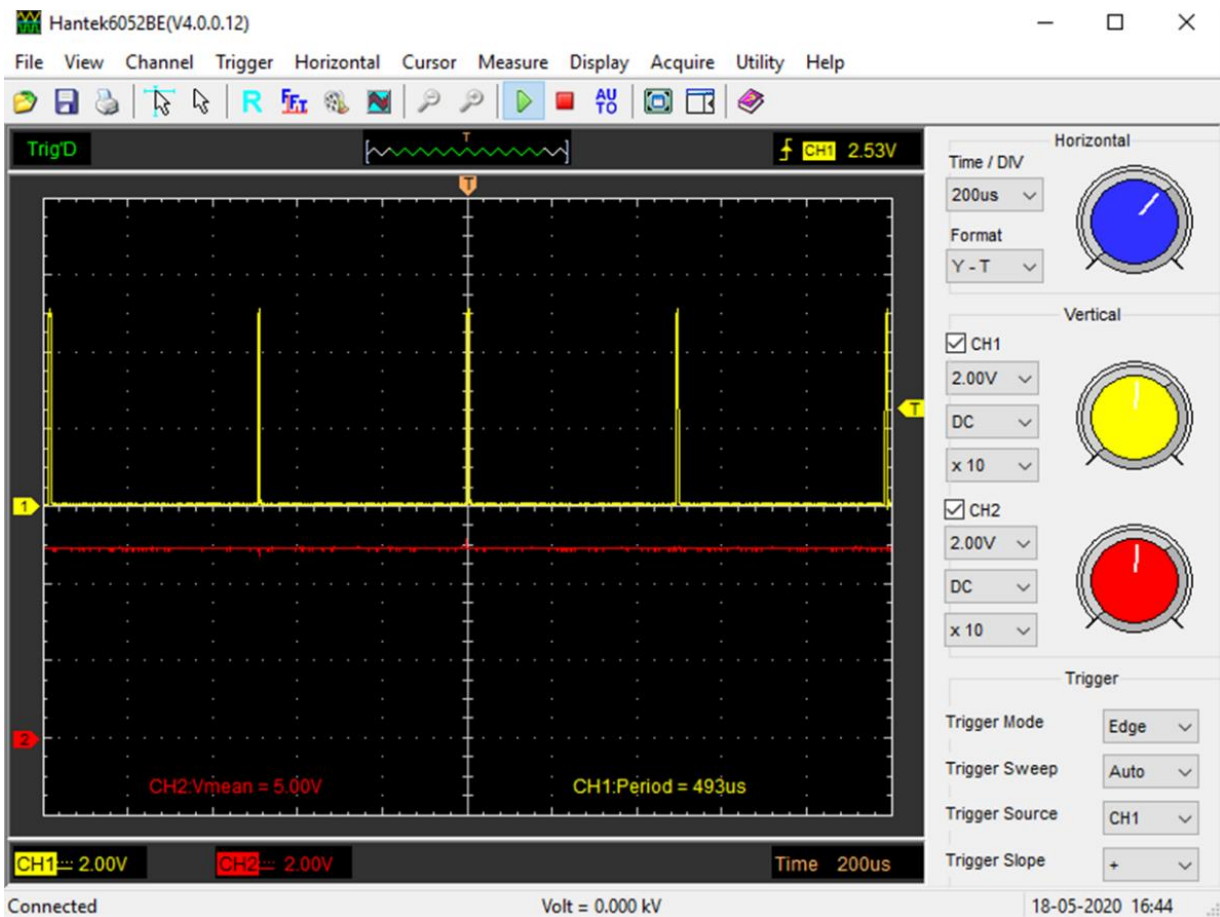

Figure 14. EOC Pin Output, SM

The SM measurement takes approximately $493\mu\text{s} - 73\mu\text{s} = 420\mu\text{s}$.

5.3 Scheduler with AZSM + SM

To add and enable the AZ signal measurement, use the settings shown in Figure 15. Monitoring the EOC, the timing is shown in Figure 16.

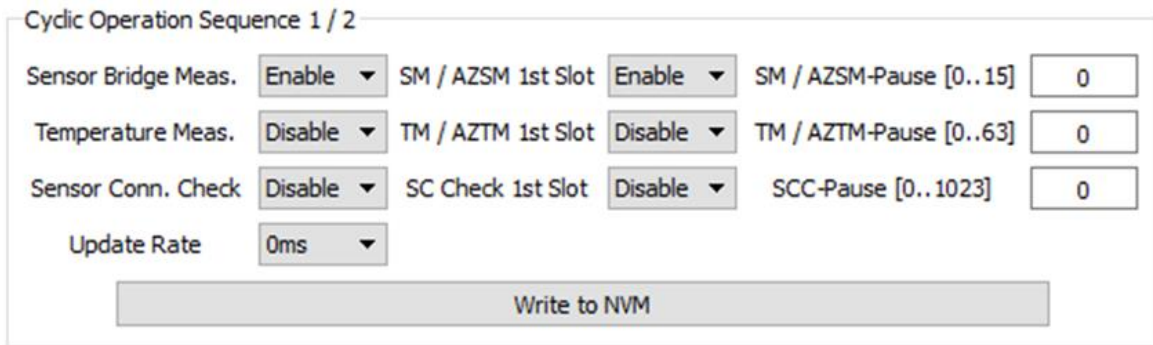

Figure 15. Scheduler Settings AZSM + SM

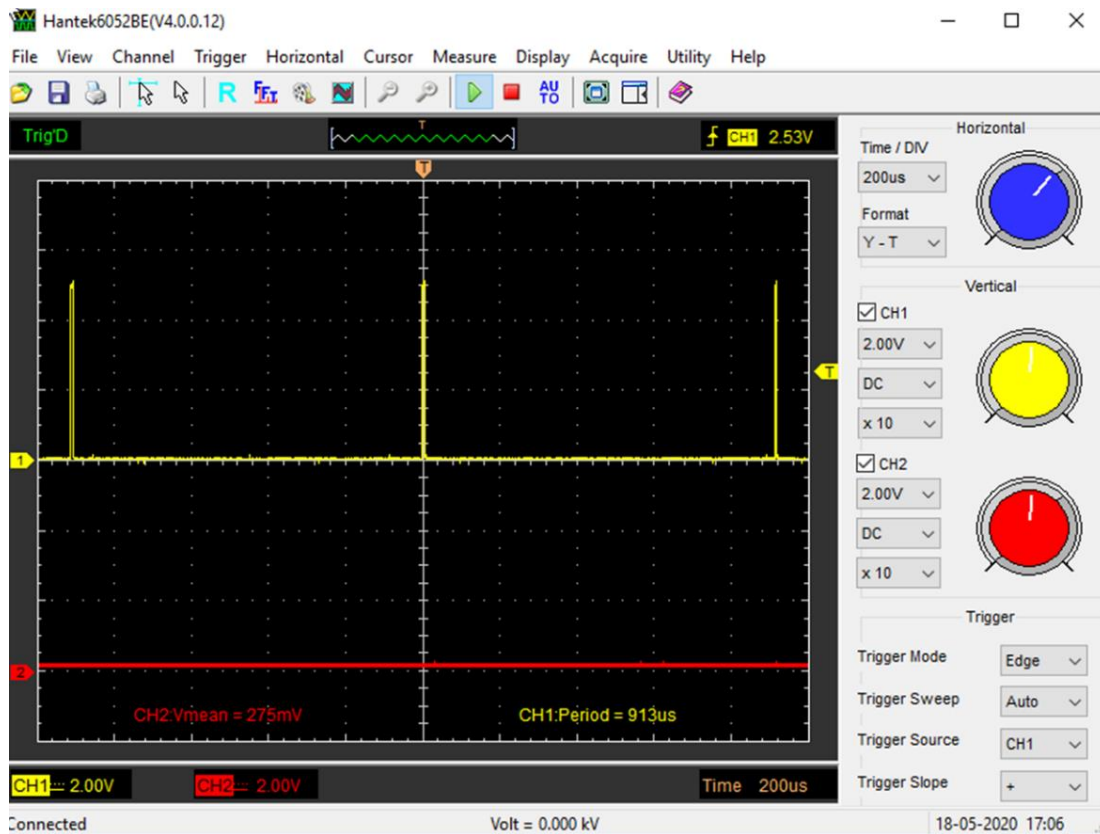

Figure 16. EOC Pin AZSM + SM

The timing accounts for 420µs (AZSM) + 420µs (SM) + 73µs = 913µs.

5.4 Scheduler with External AZTM + TM

Data can be collected for the external temperature sensor. Summary of the measurements (not included for brevity) shows the same behavior as the SM.

The timing accounts for 419µs (AZTM) + 419µs (TM) + 73µs = 911µs.

5.5 Scheduler with AZSM, SM, AZTM and TM

The full set of measurements is achievable with the settings in Figure 17.

Cyclic Operation Sequence 1 / 2

Sensor Bridge Meas.	Enable	SM / AZSM 1st Slot	Enable	SM / AZSM-Pause [0..15]	0
Temperature Meas.	Enable	TM / AZTM 1st Slot	Enable	TM / AZTM-Pause [0..63]	0
Sensor Conn. Check	Disable	SC Check 1st Slot	Disable	SCC-Pause [0..1023]	0
Update Rate	0ms				

Write to NVM

Figure 17. Scheduler Settings AZSM + SM + AZTM + TM

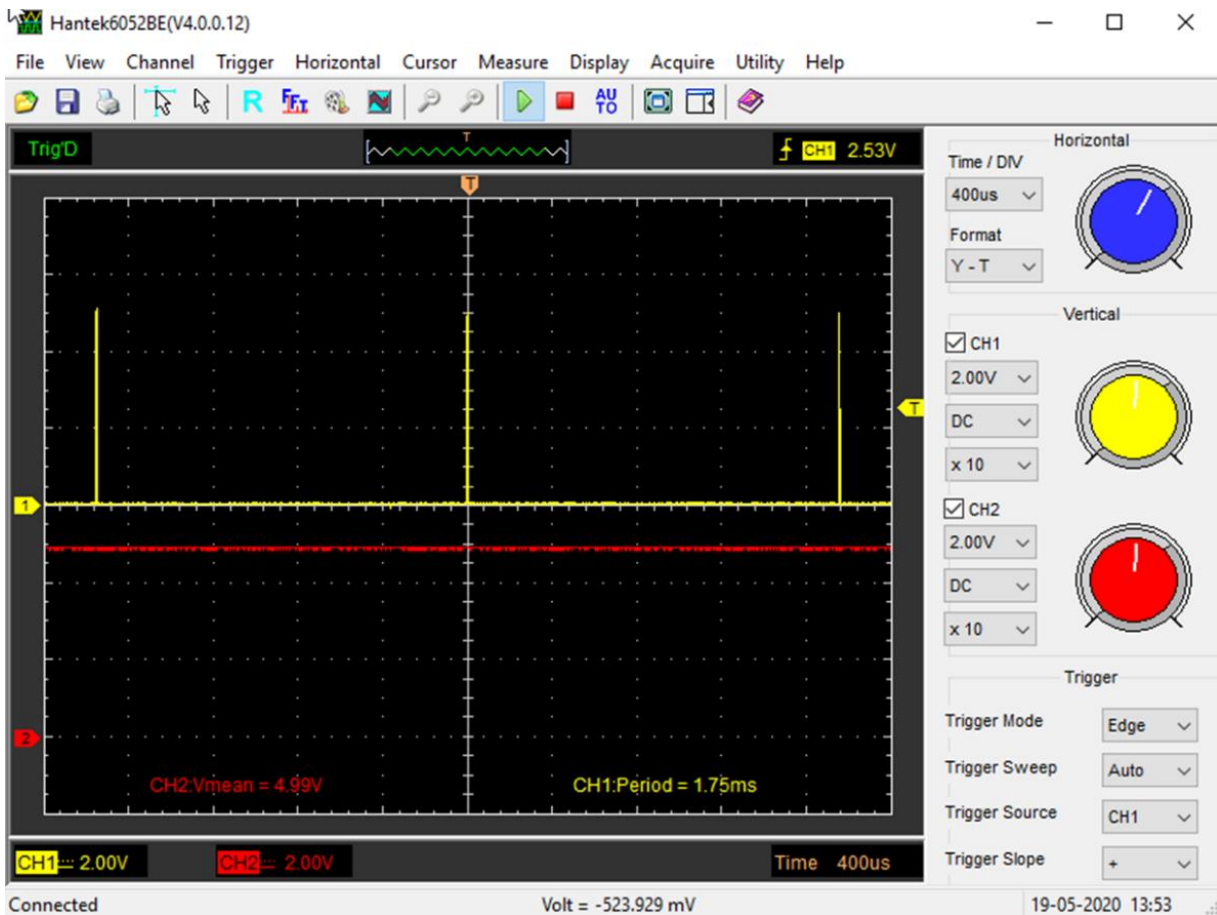

Figure 18. EOC Pin AZSM + SM + AZTM + TM

Summary of measured EOC timings is provided in Figure 19.

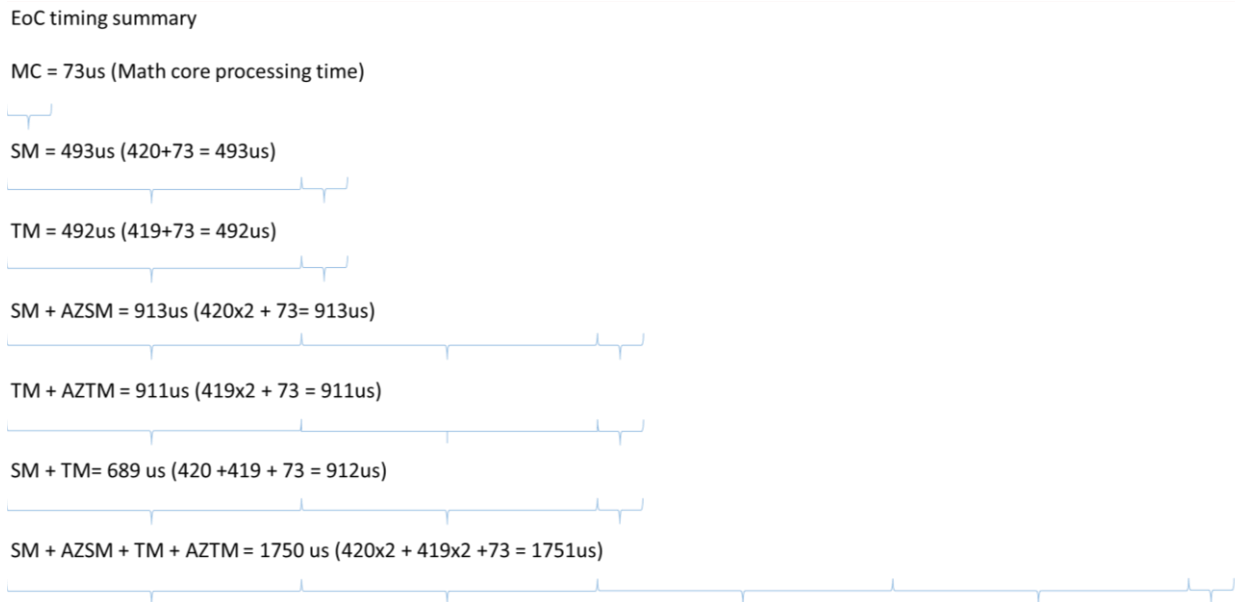

Figure 19. Summary of Measured EOC Timings

5.6 Sensor Connection Check

The diagnostic checks available in the ZSSC3240 are one component of the tasks that can be included by the scheduler, in addition to the sensor and temperature measurements. “Cyclic Operation Sequence 1 / 2” part of the GUI settings are dedicated to show these measurements, see Figure 20. The set of the checks to be performed can be defined using the selection boxes of the “On-Chip Diagnostic” section in the Diagnostic Tab of the GUI.

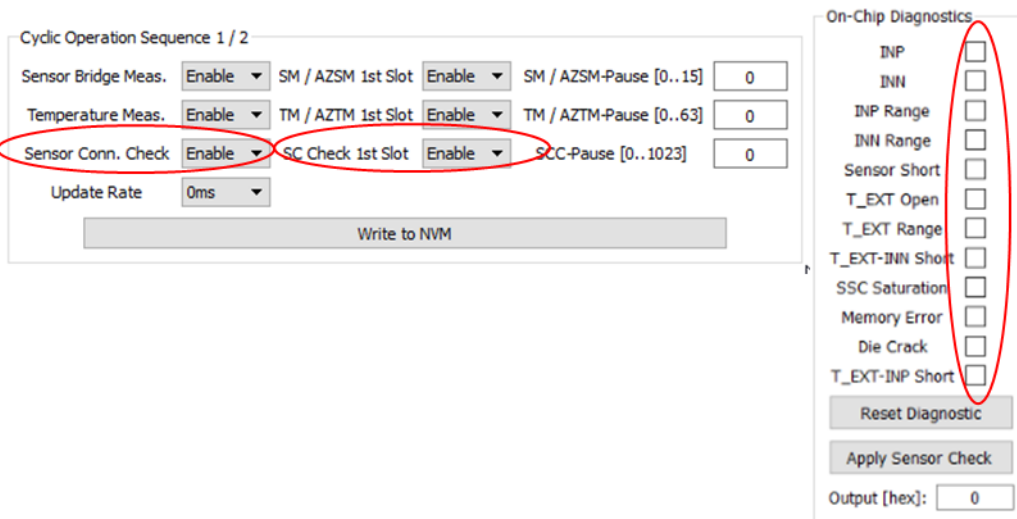

Figure 20. Scheduler Settings SC Check and Checks Selection

The amount of time (time between two consecutive EOC pulses) for the sole SC check depends on the number of check selected and spans about from 80µs and 347µs (all checks active).

5.7 Update Rate

The scheduler allows the introduction of a selectable delay between the measurement slots, as shown in Figure 21.

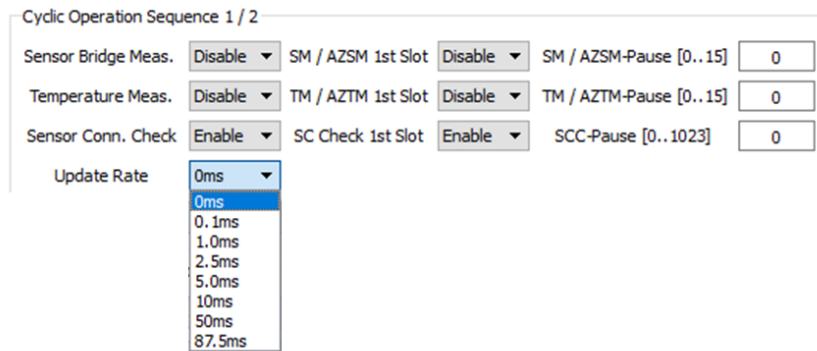

Figure 21. Update Rate Setting

The selection of 1ms delay in a AZSM+SM+AZTM+TM sequence with 1 slot pause for the temperature measurement is shown in Figure 22.

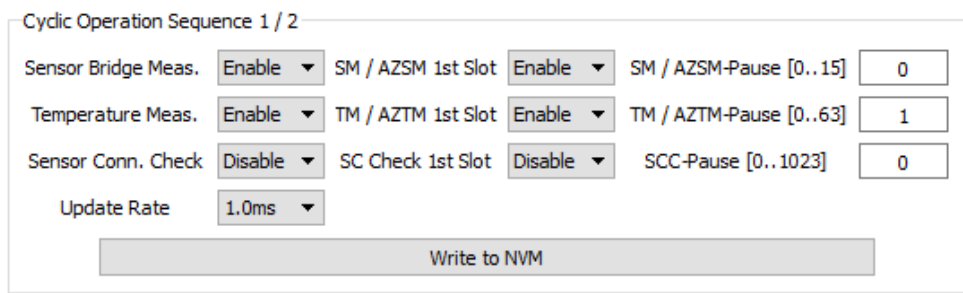

Figure 22. 1ms Update Rate Delay

The result of the above setting is displayed in Figure 23. It shows a slot with AZSM+SM+1ms delay (approximately 0,92ms + 1ms ~ 1,98ms) and a slot with AZSM+SM+AZTM+TM+1ms delay (1,84ms + 1ms ~ 2,826ms).

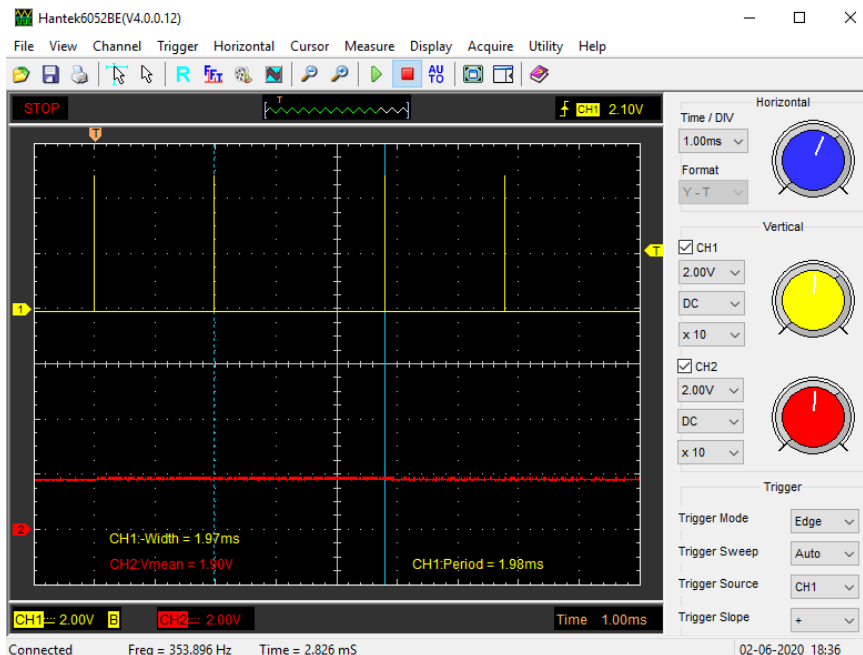

Figure 23. Measurements Slots with 1ms Delay

6. Scheduler Operation Examples

6.1 Example 1

The desired measurements slots sequence is displayed in Figure 24.

SLOT N°	Measurements
0	AZSM + SM +AZTM +TM
1	No Measurement (*)
2	AZTM +TM
3	AZSM + SM
4	AZTM +TM
5	No Measurement (*)
Repeat from 0	AZSM + SM +AZTM +TM

Figure 24. Example 1 Sequence

In Figure 25 the required GUI settings are described.

Cyclic Operation Sequence 1 / 2

Sensor Bridge Meas.	Enable ▾	SM / AZSM 1st Slot	Enable ▾	SM / AZSM-Pause [0..15]	1
Temperature Meas.	Enable ▾	TM / AZTM 1st Slot	Enable ▾	TM / AZTM-Pause [0..63]	2
Sensor Conn. Check	Disable ▾	SC Check 1st Slot	Disable ▾	SCC-Pause [0..1023]	0
Update Rate	0ms ▾				

Figure 25. Example 1 GUI Settings

The result, after activation of the Cyclic Mode, is visible in Figure 26, the slots are identified by the red arrows.

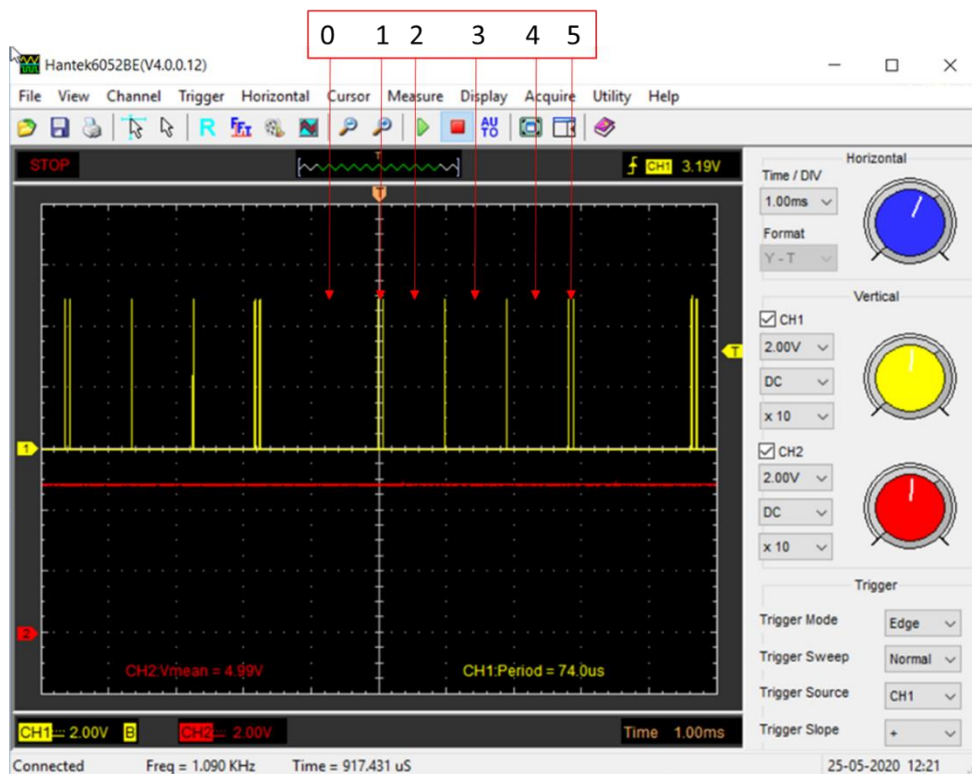

The “no measurements” slot, math core operation time, lasts about 73µs.

Figure 26. Example 1 Slot Timings

6.2 Example 2

The desired measurements slots sequence is displayed in Figure 27.

SLOT N°	Measurements
0	AZSM + SM +AZTM +TM
1	No Measurement (*)
2	No Measurement (*)
3	AZTM +TM
4	AZSM + SM
5	No Measurement (*)
6	AZTM +TM
7	No Measurement (*)
8	AZSM + SM
9	AZTM +TM
10	No Measurement (*)
11	No Measurement (*)
Repeat from 0	AZSM + SM +AZTM +TM

Figure 27. Example 2 Sequence

In Figure 28 the required GUI settings are described.

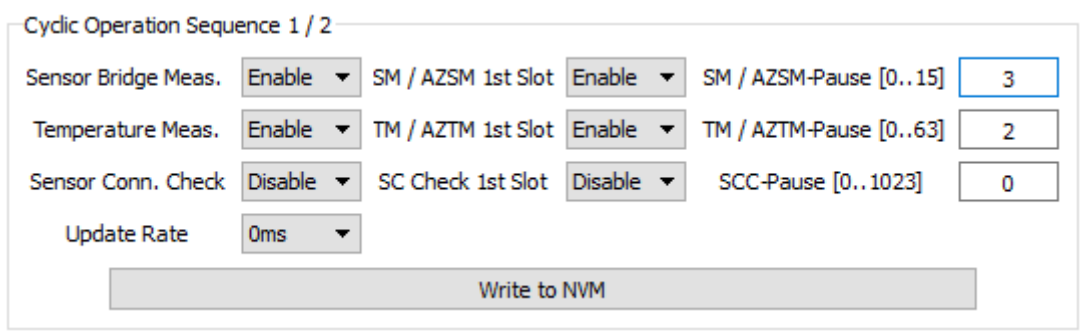

The "no measurements" slot, math core operation time, lasts about 73µs.

Figure 28. Example 2 GUI Settings

The result, after activation of the Cyclic Mode, is visible in Figure 29, the slots are identified by the red arrows.

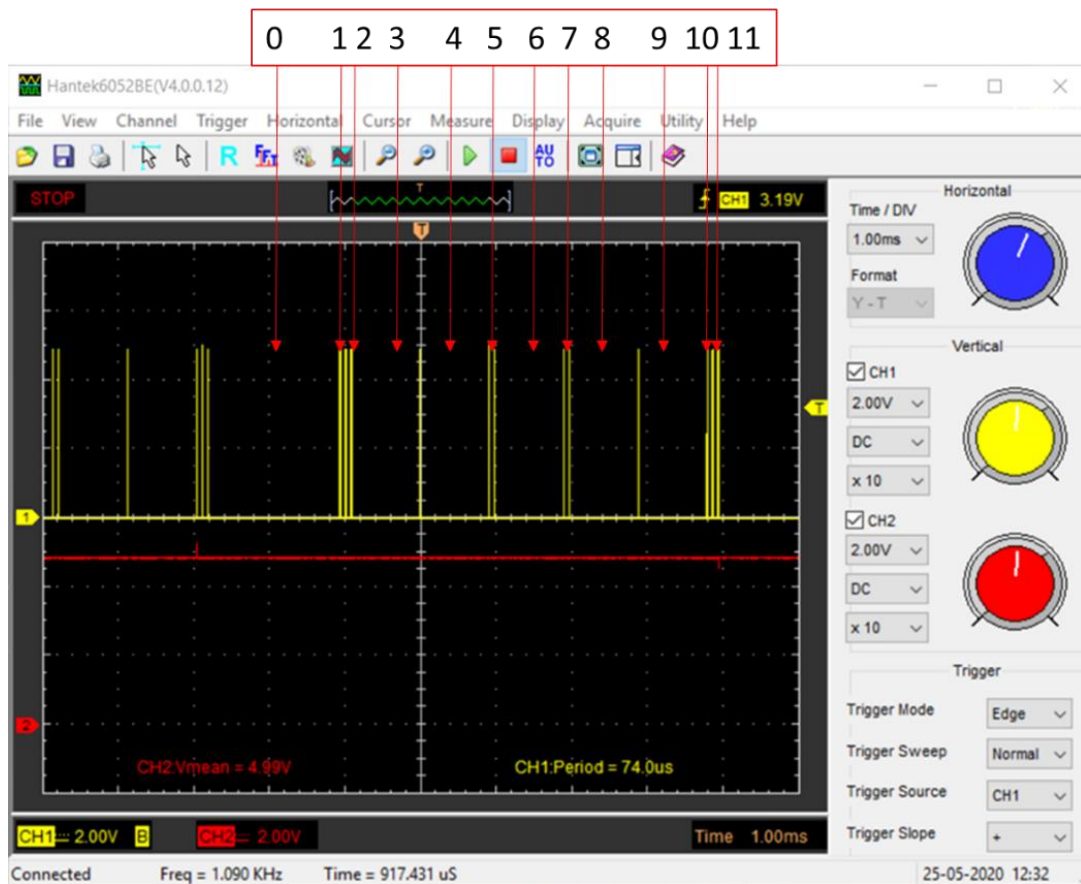

Figure 29. Example 2 Slot Timings

6.3 Example 3

The desired measurements slots sequence is displayed in Figure 30.

SLOT N°	Measurements
0	AZSM + SM + ASTM +TM+ SC check
1	SC Check
2	AZSM + SM + SC check
3	AZTM + TM + SC check
4	AZSM + SM + SC check
5	SC Check
Repeat from 0	AZSM + SM + ASTM +TM+ SC check

Figure 30. Example 3 Sequence

In Figure 31 the required GUI settings are described.

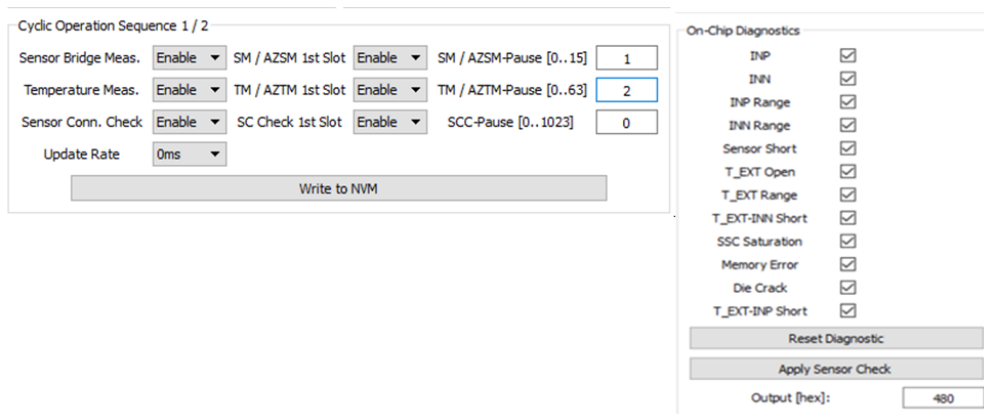

Figure 31. Example 3 GUI Settings

The result, after activation of the Cyclic Mode, is visible in Figure 32, the slots are identified by the red arrows.

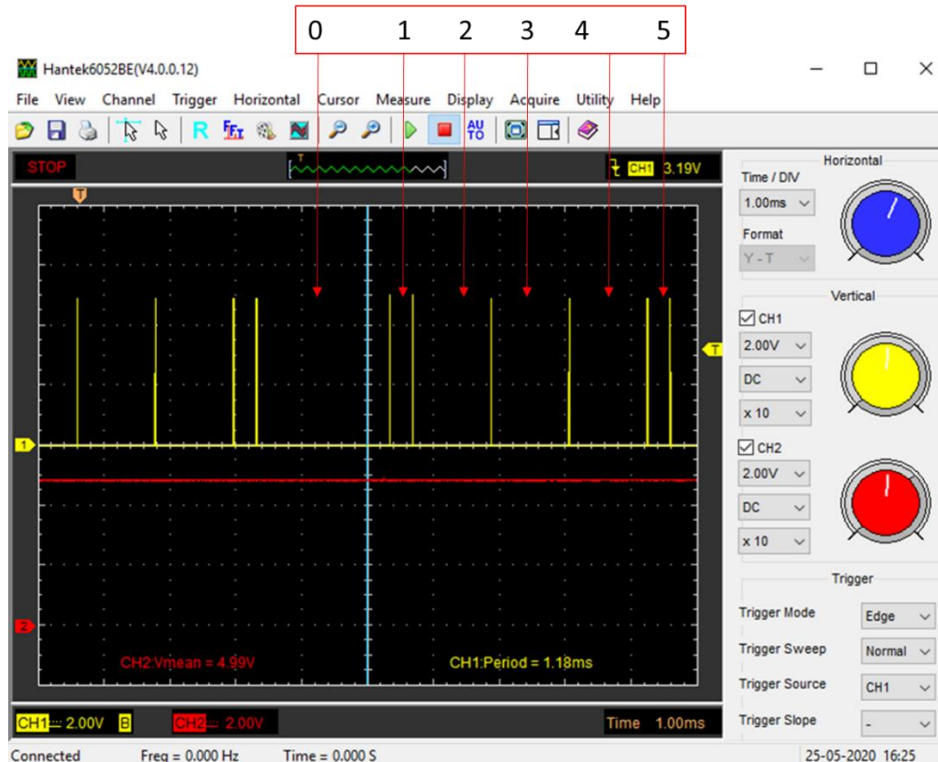

Figure 32. Example 3 Slot Timings

7. Glossary

Term	Description
AZ	Auto Zero
AZSM	Auto Zero Sensor Measurement
AZTM	Auto Zero Temperature Measurement
SM	Sensor Measurement
TM	Temperature Measurement
SC	Sensor Connection
GUI	Graphical User Interface
IC	Integrated Circuit
NVM	Non Volatile Memory
PC	Personal Computer
SSC	Sensor Signal Conditioner
EOC	End of Conversion
MC	Math Core

8. Revision History

Revision	Date	Description
1.00	Jul 7, 2022	Initial release.

Notice

1. Descriptions of circuits, software and other related information in this document are provided only to illustrate the operation of semiconductor products and application examples. You are fully responsible for the incorporation or any other use of the circuits, software, and information in the design of your product or system. Renesas Electronics disclaims any and all liability for any losses and damages incurred by you or third parties arising from the use of these circuits, software, or information.
2. Renesas Electronics hereby expressly disclaims any warranties against and liability for infringement or any other claims involving patents, copyrights, or other intellectual property rights of third parties, by or arising from the use of Renesas Electronics products or technical information described in this document, including but not limited to, the product data, drawings, charts, programs, algorithms, and application examples.
3. No license, express, implied or otherwise, is granted hereby under any patents, copyrights or other intellectual property rights of Renesas Electronics or others.
4. You shall be responsible for determining what licenses are required from any third parties, and obtaining such licenses for the lawful import, export, manufacture, sales, utilization, distribution or other disposal of any products incorporating Renesas Electronics products, if required.
5. You shall not alter, modify, copy, or reverse engineer any Renesas Electronics product, whether in whole or in part. Renesas Electronics disclaims any and all liability for any losses or damages incurred by you or third parties arising from such alteration, modification, copying or reverse engineering.
6. Renesas Electronics products are classified according to the following two quality grades: "Standard" and "High Quality". The intended applications for each Renesas Electronics product depends on the product's quality grade, as indicated below.
 - "Standard": Computers; office equipment; communications equipment; test and measurement equipment; audio and visual equipment; home electronic appliances; machine tools; personal electronic equipment; industrial robots; etc.
 - "High Quality": Transportation equipment (automobiles, trains, ships, etc.); traffic control (traffic lights); large-scale communication equipment; key financial terminal systems; safety control equipment; etc.
- Unless expressly designated as a high reliability product or a product for harsh environments in a Renesas Electronics data sheet or other Renesas Electronics document, Renesas Electronics products are not intended or authorized for use in products or systems that may pose a direct threat to human life or bodily injury (artificial life support devices or systems; surgical implantations; etc.), or may cause serious property damage (space system; undersea repeaters; nuclear power control systems; aircraft control systems; key plant systems; military equipment; etc.). Renesas Electronics disclaims any and all liability for any damages or losses incurred by you or any third parties arising from the use of any Renesas Electronics product that is inconsistent with any Renesas Electronics data sheet, user's manual or other Renesas Electronics document.
7. No semiconductor product is absolutely secure. Notwithstanding any security measures or features that may be implemented in Renesas Electronics hardware or software products, Renesas Electronics shall have absolutely no liability arising out of any vulnerability or security breach, including but not limited to any unauthorized access to or use of a Renesas Electronics product or a system that uses a Renesas Electronics product. RENESAS ELECTRONICS DOES NOT WARRANT OR GUARANTEE THAT RENESAS ELECTRONICS PRODUCTS, OR ANY SYSTEMS CREATED USING RENESAS ELECTRONICS PRODUCTS WILL BE INVULNERABLE OR FREE FROM CORRUPTION, ATTACK, VIRUSES, INTERFERENCE, HACKING, DATA LOSS OR THEFT, OR OTHER SECURITY INTRUSION ("Vulnerability Issues"). RENESAS ELECTRONICS DISCLAIMS ANY AND ALL RESPONSIBILITY OR LIABILITY ARISING FROM OR RELATED TO ANY VULNERABILITY ISSUES. FURTHERMORE, TO THE EXTENT PERMITTED BY APPLICABLE LAW, RENESAS ELECTRONICS DISCLAIMS ANY AND ALL WARRANTIES, EXPRESS OR IMPLIED, WITH RESPECT TO THIS DOCUMENT AND ANY RELATED OR ACCOMPANYING SOFTWARE OR HARDWARE, INCLUDING BUT NOT LIMITED TO THE IMPLIED WARRANTIES OF MERCHANTABILITY, OR FITNESS FOR A PARTICULAR PURPOSE.
8. When using Renesas Electronics products, refer to the latest product information (data sheets, user's manuals, application notes, "General Notes for Handling and Using Semiconductor Devices" in the reliability handbook, etc.), and ensure that usage conditions are within the ranges specified by Renesas Electronics with respect to maximum ratings, operating power supply voltage range, heat dissipation characteristics, installation, etc. Renesas Electronics disclaims any and all liability for any malfunctions, failure or accident arising out of the use of Renesas Electronics products outside of such specified ranges.
9. Although Renesas Electronics endeavors to improve the quality and reliability of Renesas Electronics products, semiconductor products have specific characteristics, such as the occurrence of failure at a certain rate and malfunctions under certain use conditions. Unless designated as a high reliability product or a product for harsh environments in a Renesas Electronics data sheet or other Renesas Electronics document, Renesas Electronics products are not subject to radiation resistance design. You are responsible for implementing safety measures to guard against the possibility of bodily injury, injury or damage caused by fire, and/or danger to the public in the event of a failure or malfunction of Renesas Electronics products, such as safety design for hardware and software, including but not limited to redundancy, fire control and malfunction prevention, appropriate treatment for aging degradation or any other appropriate measures. Because the evaluation of microcomputer software alone is very difficult and impractical, you are responsible for evaluating the safety of the final products or systems manufactured by you.
10. Please contact a Renesas Electronics sales office for details as to environmental matters such as the environmental compatibility of each Renesas Electronics product. You are responsible for carefully and sufficiently investigating applicable laws and regulations that regulate the inclusion or use of controlled substances, including without limitation, the EU RoHS Directive, and using Renesas Electronics products in compliance with all these applicable laws and regulations. Renesas Electronics disclaims any and all liability for damages or losses occurring as a result of your noncompliance with applicable laws and regulations.
11. Renesas Electronics products and technologies shall not be used for or incorporated into any products or systems whose manufacture, use, or sale is prohibited under any applicable domestic or foreign laws or regulations. You shall comply with any applicable export control laws and regulations promulgated and administered by the governments of any countries asserting jurisdiction over the parties or transactions.
12. It is the responsibility of the buyer or distributor of Renesas Electronics products, or any other party who distributes, disposes of, or otherwise sells or transfers the product to a third party, to notify such third party in advance of the contents and conditions set forth in this document.
13. This document shall not be reprinted, reproduced or duplicated in any form, in whole or in part, without prior written consent of Renesas Electronics.
14. Please contact a Renesas Electronics sales office if you have any questions regarding the information contained in this document or Renesas Electronics products.

(Note1) "Renesas Electronics" as used in this document means Renesas Electronics Corporation and also includes its directly or indirectly controlled subsidiaries.

(Note2) "Renesas Electronics product(s)" means any product developed or manufactured by or for Renesas Electronics.

(Disclaimer Rev.5.0-1)

Corporate Headquarters

TOYOSU FORESIA, 3-2-24 Toyosu,
Koto-ku, Tokyo 135-0061, Japan
www.renesas.com

Trademarks

Renesas and the Renesas logo are trademarks of Renesas Electronics Corporation. All trademarks and registered trademarks are the property of their respective owners.

Contact Information

For further information on a product, technology, the most up-to-date version of a document, or your nearest sales office, please visit:
www.renesas.com/contact/