

## ZSSC3286KIT

This document provides a comprehensive guide to the ZSSC3286 Evaluation Kit, explaining its hardware and software design, the required setup procedures and the steps for configuring and evaluating the ZSSC3286 sensor signal conditioning IC.

Target device: ZSSC3286 IO-Link Ready Dual Channel Resistive Sensor Signal Conditioner IC.

## Contents

<b>1. Evaluation Kit Contents .....</b>	<b>7</b>
<b>2. Evaluation Kit Setup .....</b>	<b>8</b>
2.1 User Computer .....	8
2.1.1. Computer Requirements .....	8
2.1.2. Software Installation and Setup .....	8
2.2 Board Configuration and Connection .....	9
2.3 Evaluation Kit Hardware Connections .....	11
2.4 Communication Interfaces and Logic Levels .....	11
2.5 Power-Up Procedure .....	12
<b>3. ZSSC3286 Application GUI .....</b>	<b>13</b>
3.1 Body .....	13
3.1.1. Menu Bar .....	13
3.1.2. Active Boards .....	16
3.1.3. Connection .....	16
3.1.4. IC Status .....	16
3.1.5. I/O Functions .....	17
3.1.6. System Status Bar .....	17
3.2 Main Tab .....	18
3.3 Configure Tab .....	19
3.3.1. AFE Tab .....	19
3.3.2. TLC Tab .....	37
3.3.3. Output Scaling Tab .....	38
3.3.4. Output Data Clipping Tab .....	40
3.3.5. AOUT Tab .....	41
3.3.6. Filter Tab .....	46
3.3.7. Alarm Tab .....	47
3.3.8. System Control Tab .....	48
3.3.9. ID Parameters Tab .....	48
3.3.10. PHY Tab .....	49
3.4 Calibration Tab .....	50
3.4.1. Sensor Selection and Acquisition Settings .....	51
3.4.2. Calibration Type Settings .....	51
3.4.3. Temperature Range .....	52
3.4.4. Calibration Points .....	52

3.4.5.	Calculating and Setting Coefficient Results .....	53
3.5	Diagnostic Tab .....	54
3.5.1.	User Selectable Input Fields .....	54
3.5.2.	Diagnostics Operation .....	55
3.5.3.	AFE Diagnostic Status .....	55
3.5.4.	AFE Diagnostic Operation Example .....	55
3.6	IO-Link Tab .....	56
3.6.1.	SSP Channel Mapping Tab .....	56
3.6.2.	SSP Scaling Tab .....	57
3.6.3.	Switching Channels Tab .....	59
3.6.4.	Device Control Tab .....	62
3.6.5.	Events Tab .....	63
3.6.6.	IODD Generator Tab .....	63
3.7	Measure Tab .....	68
3.7.1.	Measure Options .....	68
3.7.2.	Graphs Area .....	71
3.7.3.	Save Data .....	71
3.8	Memory .....	72
3.8.1.	Overview .....	72
3.8.2.	View Register .....	73
3.9	FW Update Tab .....	75
3.10	Command Console .....	76
3.10.1.	Select Script and Execute .....	76
3.10.2.	Type Single Command and Execute .....	76
3.10.3.	Result Display .....	77
3.10.4.	Clear Display .....	77
<b>4.</b>	<b>GUI and FW Revision References .....</b>	<b>77</b>
<b>5.</b>	<b>References .....</b>	<b>77</b>
<b>6.</b>	<b>Glossary .....</b>	<b>78</b>
<b>7.</b>	<b>Revision History .....</b>	<b>79</b>

## Figures

Figure 1.	ZSSC3286 EVB V3 Default Configuration .....	9
Figure 2.	RH4Z2501 PMOD Default Configuration .....	9
Figure 3.	SSCSR3V3 Default Configuration .....	10
Figure 4.	ZSSC3286KIT – Overview .....	11
Figure 5.	Top Menu .....	13
Figure 6.	File Menu .....	13
Figure 7.	Settings Menu .....	13
Figure 8.	CCP and Firmware Password Pop-Up .....	14
Figure 9.	Settings Menu – Warnings .....	14
Figure 10.	Tools Menu .....	14
Figure 11.	Tools Menu – Open Logfile .....	14
Figure 12.	Tools Menu – Command Console .....	15

Figure 13. Help Menu .....	15
Figure 14. About Pop-Up .....	15
Figure 15. Active Boards .....	16
Figure 16. Active Boards - Tooltip .....	16
Figure 17. Connection area .....	16
Figure 18. IC Status .....	17
Figure 19. I/O Functions for I2C Connection .....	17
Figure 20. System Status Bar for I2C Connection.....	18
Figure 21. Block Diagram on Main Tab .....	18
Figure 22. AFE Selection and Configurability .....	19
Figure 23. Sequencer Error Message .....	19
Figure 24. Sequencer Main Mode .....	20
Figure 25. SM/AUX Combinations for Deterministic Sensor Step Response .....	20
Figure 26. SM+/SM- Exchange .....	20
Figure 27. SM+ with Auto-Zero Sensor Measurement .....	20
Figure 28. Number of AUX measurements and Idle Time .....	20
Figure 29. Accelerated Main Measurement.....	21
Figure 30. SM/AUX Combinations for Accelerated Main Measurement .....	21
Figure 31. Auxiliary Insertion Rate .....	21
Figure 32. Auxiliary Insertion Rate: SM+AUX_AZ after the Eighth Measurement .....	21
Figure 33. Temperature Selection Overview .....	22
Figure 34. Acquired Data Stream Overview .....	22
Figure 35. AFE Status .....	23
Figure 36. Temperature Sensor Activation.....	23
Figure 37. Sensor to Channel Assignment.....	23
Figure 38. Voltage Mode .....	24
Figure 39. Resistor Mode .....	24
Figure 40. Current Mode.....	25
Figure 41. Thermopile Mode.....	25
Figure 42. Configure Register.....	25
Figure 43. Meas Config Menu .....	26
Figure 44. Meas Config: Single .....	26
Figure 45. Meas Config: Single AZ.....	26
Figure 46. Bridge – Sensor Values.....	26
Figure 47. Bridge – Parameters.....	27
Figure 48. Mode Voltage Schematic .....	27
Figure 49. Internals Example.....	28
Figure 50. Internals Out of Range .....	28
Figure 51. Schematic and Graphs Selection .....	29
Figure 52. Both Graphs .....	29
Figure 53. Step Response Configuration for Bridge 1.....	29
Figure 54. Temp – Mode Sink Internal Bias .....	30
Figure 55. Temp – Mode Source Internal Bias.....	30
Figure 56. Mode Source External Bias Low .....	31
Figure 57. Mode Source External Bias High .....	31
Figure 58. External RH, RL.....	31

Figure 59. Mode Bridge Internal Bias .....	32
Figure 60. Mode Bridge External Bias .....	32
Figure 61. Mode Bridge Differential .....	33
Figure 62. Configure Register.....	33
Figure 63. Copy to Temp .....	33
Figure 64. Temp– Sensor Values .....	34
Figure 65. Parameters .....	34
Figure 66. Temp – Schematic.....	35
Figure 67. Internals .....	35
Figure 68. Internals Out of Range .....	36
Figure 69. Schematic and Graphs Selection .....	36
Figure 70. Combined Graphs .....	36
Figure 71. Pt1000 Measurements .....	37
Figure 72. Third Logic Channel Operations.....	37
Figure 73. Third Logic Channel – Channel Order .....	37
Figure 74. Output Scaling .....	38
Figure 75. Back to Defaults .....	38
Figure 76. 50% to 100% Output .....	39
Figure 77. Coefficients for 0% to 100% Output .....	39
Figure 78. 0% to 100% Output (via Output Scaling) .....	40
Figure 79. Output Data Clipping Default Settings.....	40
Figure 80. Clipping Limits .....	40
Figure 81. AOUT – Operation Mode.....	41
Figure 82. Jumpers and Switches for AOUT on ZSSC3286 EVB .....	42
Figure 83. Absolute Voltage 0V - 1V Configuration.....	42
Figure 84. Absolute Voltage 0V - 5V Configuration.....	43
Figure 85. 3-Wire Current Loop Configuration .....	44
Figure 86. 3-Wire Current Loop Calibration.....	45
Figure 87. 3-Wire Current Loop calibration Measured Coefficients .....	45
Figure 88. AOUT Pin Mapping.....	45
Figure 89. AOUT Output Stimulus .....	46
Figure 90. Filter Tab .....	46
Figure 91. Filter Time Constant Setting.....	46
Figure 92. Filter Response (Digital Domain) .....	47
Figure 93. Alarm Configuration Options .....	47
Figure 94. System Control tab .....	48
Figure 95. System Startup .....	48
Figure 96. CCP Password and Firmware Password .....	48
Figure 97. Identification Parameters.....	49
Figure 98. PHY Tab .....	49
Figure 99. PHY Current Limit.....	49
Figure 100. PHY Slew Rate Regulation .....	49
Figure 101. PHY Slew Rate.....	50
Figure 102. Calibration Tab .....	50
Figure 103. Sensor, Acquisition.....	51
Figure 104. Calibration Type .....	51

Figure 105. Curve .....	52
Figure 106. Temperature Range and Sample Settings .....	52
Figure 107. Calibration Points Input .....	53
Figure 108. Calculate Coefficients, Set in GUI .....	53
Figure 109. Coefficient Result .....	53
Figure 110. Diagnostic Tab.....	54
Figure 111. Cbr and Cts Capacitors .....	54
Figure 112. UDR/LDR Selection.....	54
Figure 113. Diagnostic Check and Reset .....	55
Figure 114. AFE Diagnostic Status .....	55
Figure 115. Activation of Diagnostic Check.....	55
Figure 116. Diagnostic Check Pass .....	55
Figure 117. Diagnostic Check Fail.....	55
Figure 118. IC Status Sensor Connection Fail .....	56
Figure 119. Structure of SSP 4.1.1 .....	56
Figure 120. SSP Channel Mapping .....	56
Figure 121. SSP Scaling Tab .....	57
Figure 122. Assignment of Physical Values, Scale and Unit.....	58
Figure 123. Process Data Range Definition .....	58
Figure 124. SSP Scaling Coefficients.....	58
Figure 125. Switching Channels Tab.....	59
Figure 126. Teach/Manual Mode.....	59
Figure 127. Switch Mode / Teach Mode .....	60
Figure 128. Teach Method.....	60
Figure 129. Setpoint fields in Manual Mode, Two Point Mode .....	60
Figure 130. Setpoint fields in Teach Mode (Static), Two Point Mode .....	61
Figure 131. Setpoint fields in Teach Mode (Dynamic), Two Point Mode .....	61
Figure 132. Logic .....	61
Figure 133. Hysteresis.....	61
Figure 134. Example for Switching Behavior Graphic in Window Mode .....	61
Figure 135. Detection Mode .....	62
Figure 136. Device Control Tab.....	62
Figure 137. Events Tab .....	63
Figure 138. IODD Generator Tab .....	63
Figure 139. IODD Generator Control.....	64
Figure 140. IODD Generator Mode .....	64
Figure 141. Error Message from GUI .....	65
Figure 142. Error Message Examples from IODD Generator (JSON Configuration File Errors) .....	66
Figure 143. Error message from IODD Checker .....	67
Figure 144. Warning Message: IODD Generator is not Available.....	67
Figure 145. Measure Tab .....	68
Figure 146. Measure Type.....	68
Figure 147. "Sensor as" Options for "Analog" .....	69
Figure 148. "Temperature as" Options for "Raw" .....	69
Figure 149. Display Selection for Measure Type "Raw" .....	70
Figure 150. Display Selection for Measure Type "IO-Link PD" .....	70

Figure 151. Display Selection for Measure Type "Analog" .....	70
Figure 152. Measurement Acquisition .....	70
Figure 153. Graphs Area .....	71
Figure 154. Save Measured Data .....	71
Figure 155. Selected Display Resolution.....	71
Figure 156. Save Displayed Data .....	72
Figure 157. Memory Overview .....	72
Figure 158. Register .....	73
Figure 159. Memory – View Register via Drop-Down List.....	73
Figure 160. Register Content .....	74
Figure 161. Modified Bits in a Register – Changes not Written to NVM .....	74
Figure 162. Firmware Meta Data .....	75
Figure 163. I2C FW Update Progress .....	75
Figure 164. IO-Link FW Update Progress .....	75
Figure 165. I2C FW Update Success Message .....	75
Figure 166. IO-Link FW Update Success Message .....	75
Figure 167. Command Console Pop-Up Window.....	76
Figure 168. Script Execution.....	76
Figure 169. Single Command execution .....	76
Figure 170. Command Execution Result.....	77
Figure 171. Clear Display .....	77

## Tables

Table 1. Kit Contents .....	7
Table 2. Communication Interfaces and Logic Levels.....	12
Table 3. Availability of I/O Functions .....	17
Table 4. System Status Bar Information Availability .....	18
Table 5. ZSSC3286 EVB Settings for AOUT Operation Modes.....	41
Table 6. Calculating Coefficients .....	51
Table 7. IODD Image File Formats.....	64
Table 8. Measure Type Availability.....	69
Table 9. Data representation format: Sensor as/Temperature as .....	69
Table 10. Stored Data Format .....	71

## 1. Evaluation Kit Contents

Find the ZSSC3286KIT on [www.renesas.com/ZSSC3286KIT](http://www.renesas.com/ZSSC3286KIT).

Find the ZSSC3286 on [www.renesas.com/ZSSC3286](http://www.renesas.com/ZSSC3286).

Table 1. Kit Contents

Position	Kit Item	Item Number	Quantity
1	ZSSC3286 Evaluation Board	ZSSC3286 EVB V3	1
2	ZSSC3286 40-QFN samples	ZSSC3286BI3R	5
3	SSC Communication Board	SSCCOMMBOARDV4P1C	1
4	SRB Sensor Replacement Board	SSCSR BV3	1
5	RH4Z2501-PMOD	RH4Z2501-PMOD	1
6	Renesas CCE4510 2-Channel IO-Link Master	CCE4510-2CH-DB-V2.1	1
7	IO-Link cable (5 Pin M12 plug to receptacle)	n.a.	1
8	USB cable (USB A to USB B)	n.a.	1
9	USB cable (USB A to USB C)	n.a.	1
10	ESD Tweezers	n.a.	1

## 2. Evaluation Kit Setup

The ZSSC3286 Evaluation Software (GUI) is intended for demonstration purposes, configuration and calibration of single units.

A Windows®-based computer is required for interfacing with the kit and configuring the ZSSC3286.

**Note:** Upon request, Renesas provides the user with algorithms and assistance in developing their full production calibration software.

### 2.1 User Computer

#### 2.1.1. Computer Requirements

**Note:** The user must have administrative rights on the computer to download and install the ZSSC3286 Evaluation Software for the kit.

The computer must meet the following requirements:

- Windows® 7, 8, 8.1, 10
- Microsoft® .NET Framework 4.0 or higher
- Supported architecture: x86 and x64
- 2x USB 2.0 port
- Internet access to download the installation setup

#### 2.1.2. Software Installation and Setup

The latest version of ZSSC3286 Evaluation Software (ZSSC3286 Application v1.0.1), which is required for the kit, is available for download from the Renesas website.

**Note:** FTDI USB drivers are needed only for backwards compatibility with older Renesas communication hardware. If these drivers are not already installed on the user's computer, the software automatically installs the correct drivers after user confirmation.

Follow these steps to install the Evaluation Software:

1. Download and extract the contents of the *zssc3286-application-setup.zip* file to the user's computer.
2. Double click on the extracted *ZSSC3286 Application Setup.exe* file.  
Follow the installation instructions displayed on the screen, changing the installation path if needed. If the default path setting is used, the software automatically completes the installation and creates an access link on the user's computer under Start > All Programs > Renesas > ZSSC3286 Application. The installation dialog offers the option to create a desktop short-cut icon for the software if selected.
3. Configure and connect the Kit hardware as described in section 2.2 and 2.3.
4. Start the ZSSC3286 Application.  
On first start, the software asks for network permission for setting up the IO-Link communication server. For operating the ZSSC3286 Evaluation Software, see section 3.



## 2.2 Board Configuration and Connection

The default jumper and switch settings of the relevant Kit items are shown in Figure 1, Figure 2 and Figure 3.

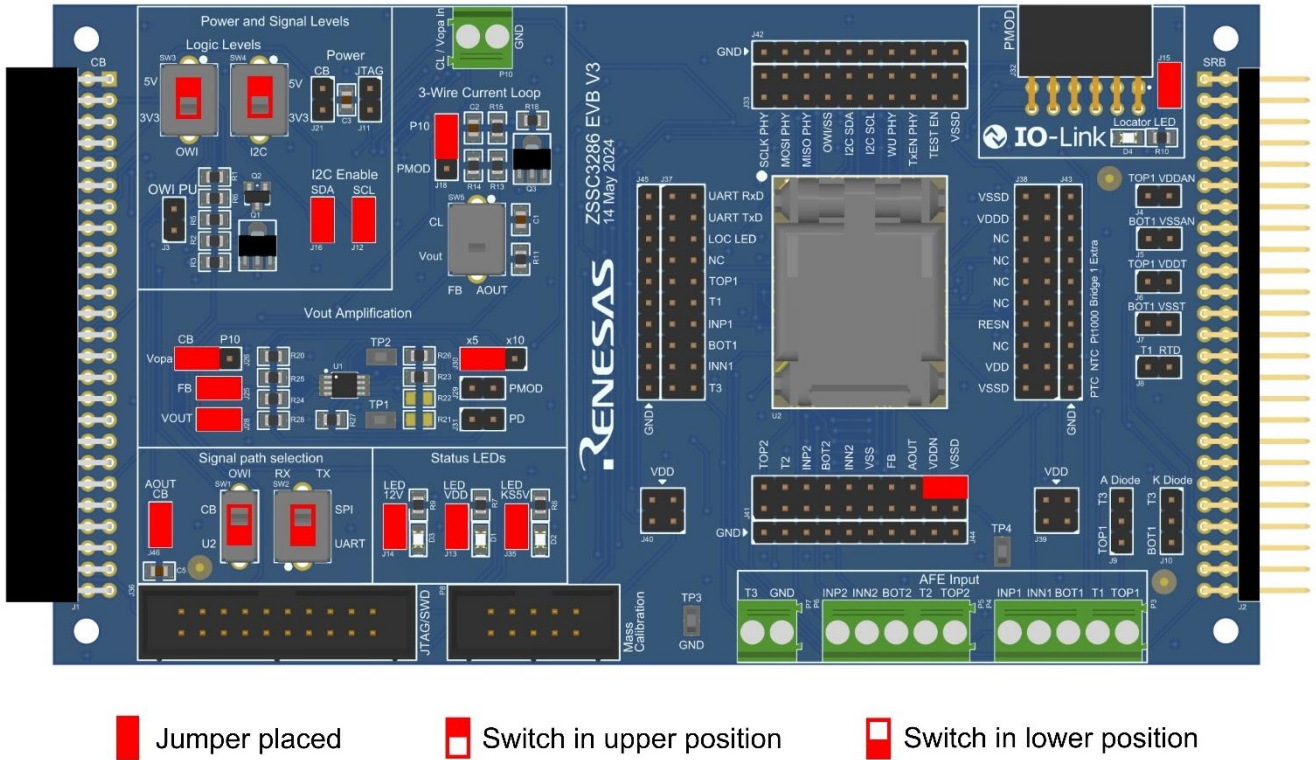

Figure 1. ZSSC3286 EVB V3 Default Configuration

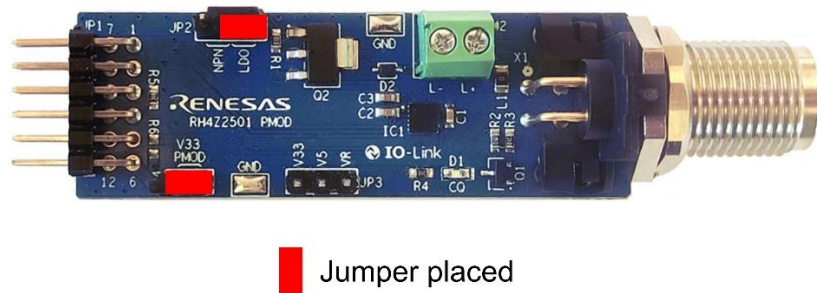
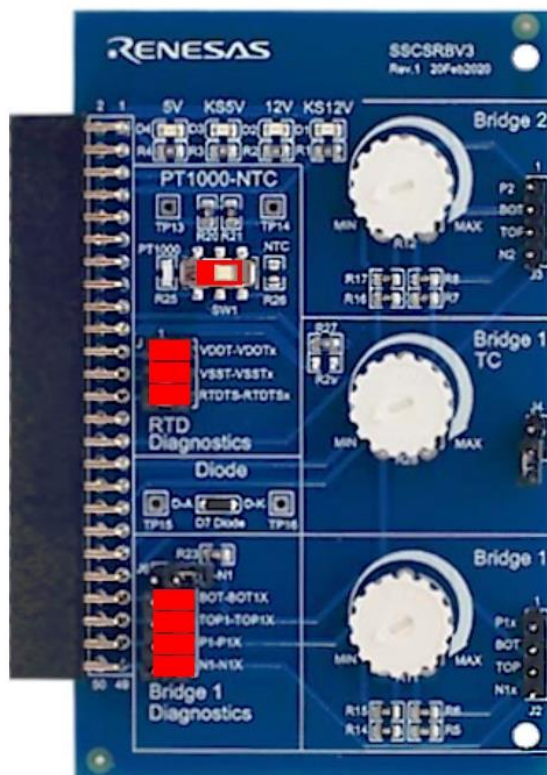

Figure 2. RH4Z2501 PMOD Default Configuration

For a complete description of the RH4Z2501-PMOD, refer to Reference 2.

**IMPORTANT NOTE:** On RH4Z2501-PMOD, some AOUT options require R6 (0Ω) to be placed to directly route Pin 2 (I/Q) of the IO-Link M12 connector (X1) (see section 3.3.5 for details). Using a different master than the Renesas CCE4510 2-Channel IO-Link Master included in the kit may destroy the ZSSC3286 EVB and/or the sample, especially if a Class B Master is used (24V supply on Pin 2).



 Jumper placed     Switch in left position

**Figure 3. SSCSR BV3 Default Configuration**

For a complete description of the SSC Communication Board V4.1 (CB), see Reference 1. Ensure to have the CB with firmware revision 4.21 or greater, to have all the GUI functionalities operational. The CB datasheet and the firmware update package are available in Reference 1.

## 2.3 Evaluation Kit Hardware Connections

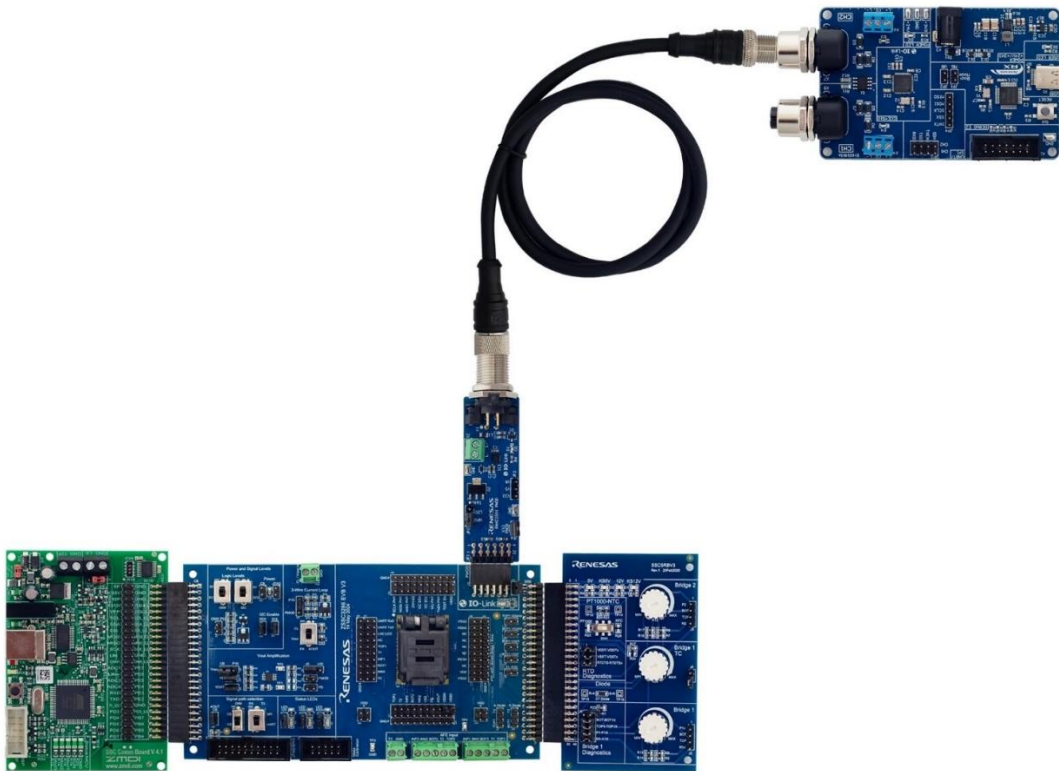

Figure 4. ZSSC3286KIT – Overview

Follow these steps to assemble the PCBs as shown in Figure 4 to start the kit with default settings:

1. Replace the dummy IC in the socket with a ZSSC3286 sample. Use the enclosed ESD safe tweezers for correct handling of the IC. Align Pin 1 with the dot on the opened socket U2 or with the dot on the silkscreen next to the upper left corner of socket U2.
2. Connect the ZSSC3286 Evaluation Board (J1) to the CB (K6).
3. Connect the ZSSC3286 Evaluation Board (J2) to the Sensor Replacement Board V3 (J1).
4. Connect the ZSSC3286 Evaluation Board (J32) to the RH4Z2501-PMOD (JP1).
5. Connect the RH4Z2501-PMOD with the IO-Link cable to the IO-Link Master.
6. For using the Renesas Master, connect via USB to the PC. Supplying the Master with 24V directly via the DC jack is not mandatory for ZSSC3286KIT operation.

**Note:** Bad electrical contact between the QFN socket and the sample can cause random connection loss or unstable output signal. Oxidation and contamination on the QFN pads and socket pins can be mitigated by carefully cleaning the contacts with compressed air and removing and installing the IC again.

**IMPORTANT NOTE:** The Evaluation Kit is designed for operation at room temperature. Use of the Kit in a thermal chamber may cause damage to the boards.

## 2.4 Communication Interfaces and Logic Levels

The ZSSC3286 and the Evaluation Board support UART (IO-Link), I2C, and OWI as communication interfaces. Only UART or I2C can be active at a time and OWI is only used to control the IO-Link PHY. Sections 3.1.3 and 3.2 provide details about the corresponding Graphical User Interface (GUI) settings.

The ZSSC3286 EVB supports 5V and 3.3V logic levels for both I2C and OWI. The logic level can be adjusted via SW4 and SW3 on the Evaluation Board. When the Evaluation Board is powered via IO-Link (3.3V), use 3.3V logic level for I2C. When the Evaluation Board is powered via CB (5V), use 5V logic levels for I2C.

**Note:** Write Memory and Firmware Update do not work via I2C in 3.3V logic level with the ZSSC3286KIT.

The ZSSC3286 Evaluation Board uses the CB to translate I2C and OWI to USB. Only one CB can be connected to the user's computer at a time to operate GUI normally. Via OWI, the CB can only configure the IO-Link PHY, not the ZSSC3286. To use OWI via CB, connection via I2C to the ZSSC3286 is mandatory.

The Renesas Master is used to translate UART (via IO-Link) to USB.

**Table 2. Communication Interfaces and Logic Levels**

Jumper/Switch	UART (IO-Link) 3.3V	UART (IO-Link) 5V	I2C 3.3V (no NVM Write/ FW Update)	I2C 5V	OWI 3.3V (via CB to RH4Z2501-PMOD)	OWI 5V (via CB to RH4Z2501-PMOD)
J21	removed	removed	Removed	set	removed	removed
J12	n.a.	n.a.	set	set	set	set
J16	n.a.	n.a.	set	set	set	set
J46	n.a.	n.a.	set	set	removed	removed
JP3 (on RH4Z2501-PMOD)	removed	set (V33 - V5)	removed	n.a.	removed	set (V33 - V5)
JP4 (on RH4Z2501-PMOD)	set	set	set	removed	set	set
SW1	U2	U2	U2	U2	CB	CB
SW3	n.a.	n.a.	n.a.	n.a.	3V3	5V
SW4	n.a.	n.a.	3V3	5V	3V3	5V

## 2.5 Power-Up Procedure

Follow these steps for powering up the EVB:

1. Connect and configure the Kit as described in sections 2.2, 2.3 and 2.4.
2. Launch the GUI.
3. Select one of the two interface options in the drop-down list at the "Connection" section on the left side of the GUI.
4. Click "Connect": The Kit will power up the EVB.

Consistency check: The GUI, at connection to the device, reads the memory of the device and automatically assesses if its configuration is consistent with the expected ones.

**IMPORTANT NOTE:** The configuration of the ZSSC3286 must be performed through the GUI. Manual modification of the configuration file (section 3.1.1.1), not followed by a consistency check of the configuration performed through the GUI, may lead to unhandled device status.

## 3. ZSSC3286 Application GUI

### 3.1 Body

The Body of the GUI is visible and accessible from any tab of the GUI and provides basic control of the ZSSC3286 Application, the interconnect boards and the ZSSC3286 IC.

#### 3.1.1. Menu Bar

The Menu Bar (Figure 5) provides access to files operation, serial bus settings, the CB log file, and software versioning information.

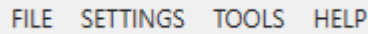

Figure 5. Top Menu

##### 3.1.1.1. File Menu

File Menu (Figure 6) allows to load and save the GUI configuration. It also provides the functionality to save the device configuration NVM to a file or to load an NVM configuration to a device from an already existing file. Default NVM configuration can be loaded to the GUI to save a misconfigured device.

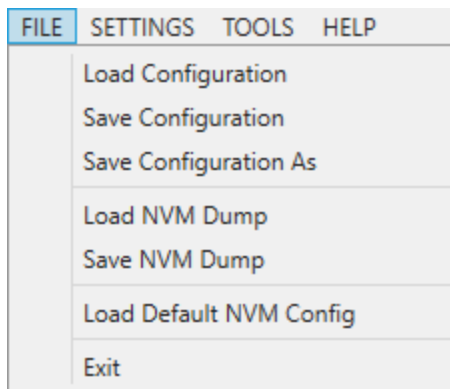

Figure 6. File Menu

##### 3.1.1.2. Settings Menu

Settings menu (Figure 7) allows to enter the CCP and the FW Password set on the currently used ZSSC3286 sample. This allows the GUI to perform “Write Memory” action and perform a firmware update.

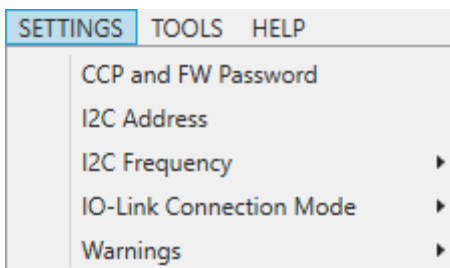

Figure 7. Settings Menu

Clicking on “CCP and FW Password” opens a pop-up window with entry fields for CCP Password and Firmware Password (Figure 8). CCP Password can be displayed in hex or decimal format by clicking on the button on the left side on the CCP Password entry field.



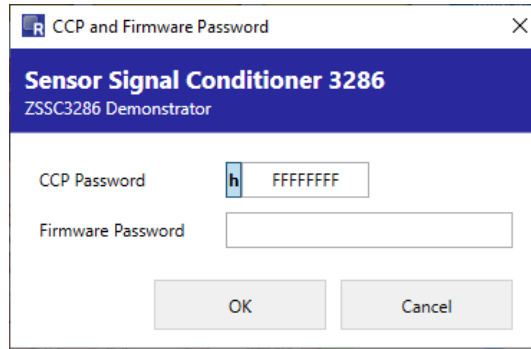

Figure 8. CCP and Firmware Password Pop-Up

The following options relevant to the digital serial buses can be modified via this menu. When connected to the ZSSC3286, the options for the currently used interface are not accessible.

- I2C: Address and Frequency
- IO-Link: Connection Mode
  - Autostart: Normal Port Mode of the IO-Link Master. Use this for configuration and calibration of ZSSC3286
  - Restore: Allows to overwrite parameters of a connected device with parameters previously stored in the Data Storage of the IO-Link Master.
  - Backup/Restore: Allows to store parameters from a connected device in the Data Storage of the IO-Link Master. Allows to overwrite parameters of a connected device with parameters previously stored in the Data Storage of the IO-Link Master.

Clicking on “Warnings” allows the user to enable or disable GUI warning messages (Figure 9).

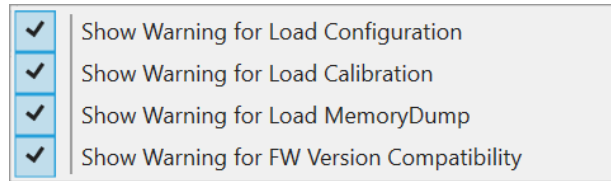

Figure 9. Settings Menu – Warnings

### 3.1.1.3. Tools Menu

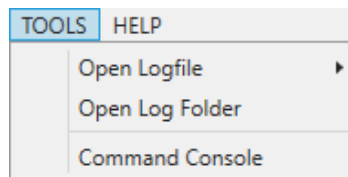

Figure 10. Tools Menu

The Tools menu (Figure 10) provides the following options:

- Open Logfile: the available Error, Communication, or Calibration log files can be opened (Figure 11).

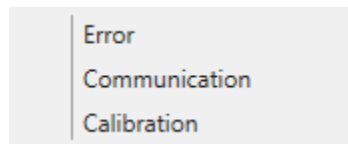

Figure 11. Tools Menu – Open Logfile

- Open Log Folder: opens the folder where the Logfile is located.
- Command Console: launches the Command Console (Figure 12), for detailed description of the available options see section 3.9.

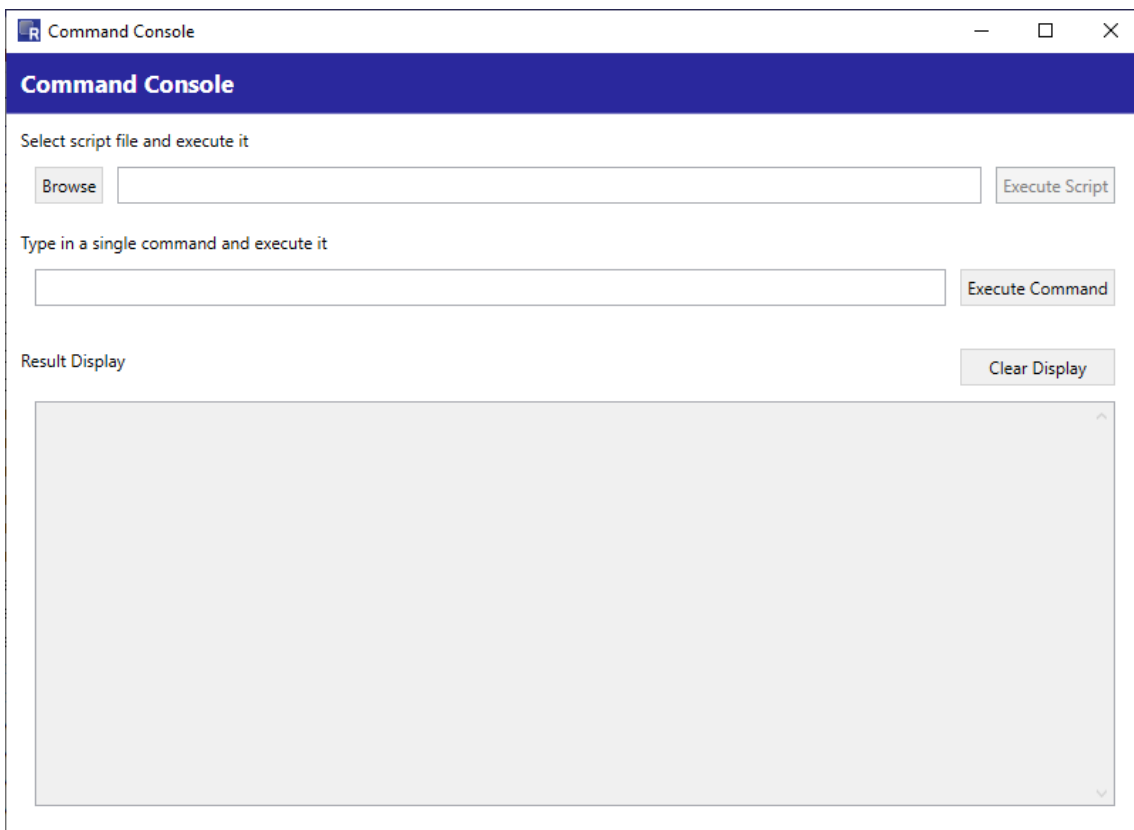

Figure 12. Tools Menu – Command Console

### 3.1.1.4. Help Menu

The Help menu (Figure 13) contains relevant information about the GUI. The “About” option displays the GUI version, the USB driver version, and the Communication Board firmware version (Figure 14).

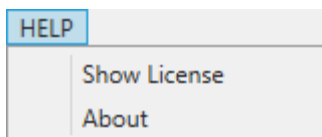
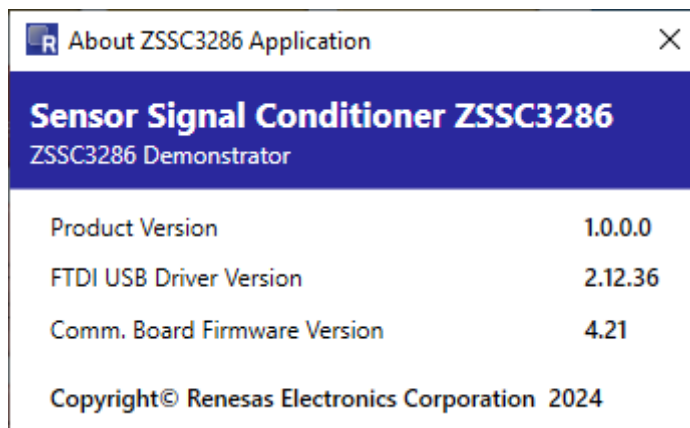

Figure 13. Help Menu



Note: GUI version may not be latest; for illustration only.

Figure 14. About Pop-Up

### 3.1.2. Active Boards

This area displays information about the CB and the IO-Link Master currently connected to the host PC (Figure 15). Tooltip information is available for the devices (Figure 16). A click on “Refresh” button checks the CB and IO-Link Master status.

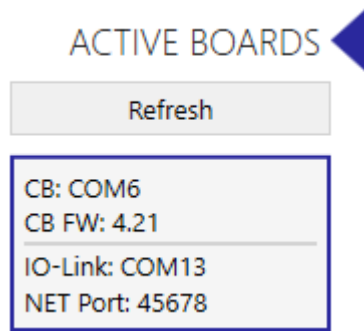

Figure 15. Active Boards

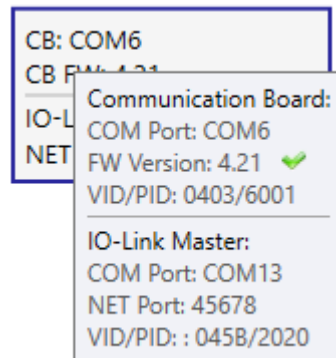

Figure 16. Active Boards - Tooltip

### 3.1.3. Connection

The connection area allows the user to control communication between the GUI, the CB / IO-Link Master and the ZSSC3286 (Figure 17) by selecting it from the drop-down menu.

**Note:** For I2C, ensure that the correct device address is set in the GUI, see section 3.1.1.2.



Figure 17. Connection area

### 3.1.4. IC Status

When the ZSSC3286 is connected via I2C, the IC Status information is highlighted with yellow status buttons (Figure 18). The IC Status is based on the device status byte described in Reference 3.

Clicking the “Read Status” button retrieves the most recent status byte. Its value in hexadecimal format is displayed above the button.

**Note:** IC Status is not available for connection via IO-Link.



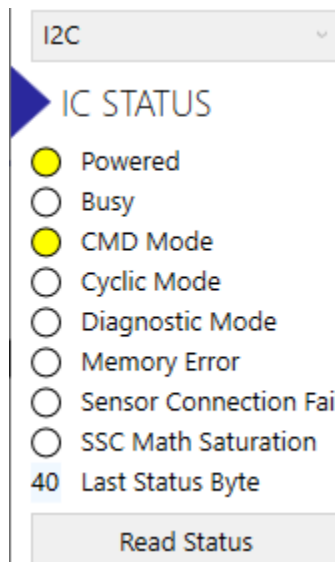

Figure 18. IC Status

### 3.1.5. I/O Functions

The I/O Functions area lists a set of buttons to perform the basic functions with the ZSSC3286 (Figure 19). Available buttons depend on the connection mode, see section 3.1.3 for details on connection modes and Table 3 for button functions.

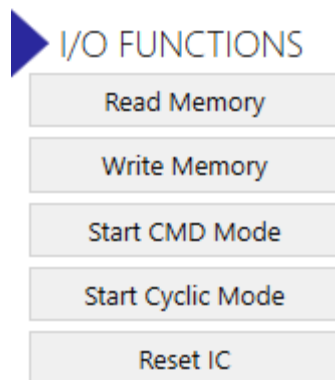

Figure 19. I/O Functions for I2C Connection

Table 3. Availability of I/O Functions

Function	I2C	IO-Link	Function
Read Memory	Yes	Yes	Reads Memory from device and sets GUI accordingly. Implicitly performs ISDU read when connected via IO-Link
Write Memory	Yes	Yes	Performs CCP update and resets device. NVM changes are fully operational at this point.
Start Command Mode	Yes	No	Starts Command Mode of the device.
Start Cyclic Mode	Yes	No	Starts Cyclic Mode of the device.
Reset IC	Yes	Yes	Performs a reset of the device.

### 3.1.6. System Status Bar

The system status bar is located at the bottom of the GUI. It displays information about connection and memory status as well as the firmware version of the IC.

Interface: I2C, Speed: 100 kHz, Address: 0x3C FW: 1.0.0 Memory Sync ●

Figure 20. System Status Bar for I2C Connection

Table 4 shows the information provided to the user in the system status bar for I2C and IO-Link connection. A green status button means that NVM and GUI are synchronized.

Table 4. System Status Bar Information Availability

Information	I2C	IO-Link
(Current) Interface	Yes	Yes
(Connection) Speed	Yes	No
(Device) Address	Yes	No
FW (RCA version)	Yes	Yes
(Status on NVM) Memory Sync	Yes	Yes

### 3.2 Main Tab

The Main tab provides a block diagram overview of the device functionalities (Figure 21). Hovering on the block diagram highlights active areas; clicking on selected items opens the relevant configuration tab.

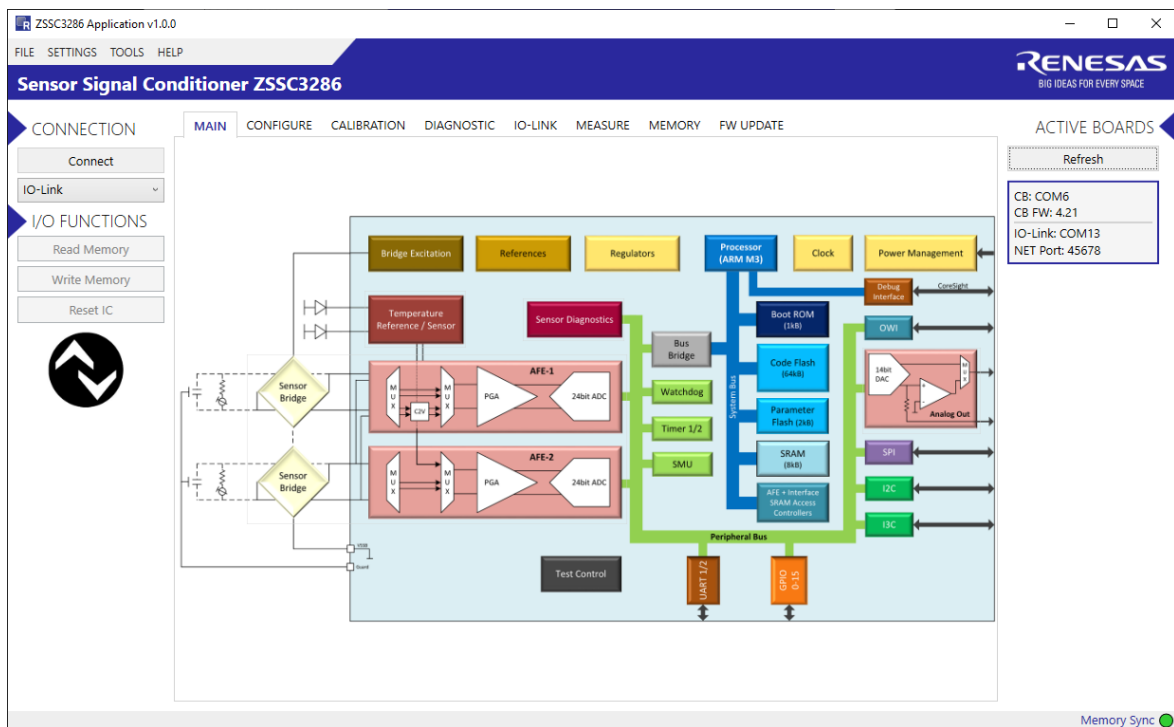

Note: GUI version may not be latest; for illustration only.

Figure 21. Block Diagram on Main Tab

## 3.3 Configure Tab

### 3.3.1. AFE Tab

#### 3.3.1.1. Sequencer Tab

The measurement flow is configurable by software. The Analog Front End (AFE) controls the measurement timing for Cyclic Mode. The SSC calculation is executed in parallel (pipelined). Once started, the measurement flow runs autonomously controlled by the AFE sequencer. Depending on configuration, it either runs continuously (Cyclic Mode) or stops after one defined measurement sequence.

Description of the operation of the sequencer is detailed in the *ZSSC3286 Datasheet* document (Reference 3).

##### 3.3.1.1.1. AFE Selection and Configurability

“The AFE Selection and Configurability” option (Figure 22) allows to configure the following options:

- AFE1 Only: AFE1 is used, only the selected AFE starts to acquire data.
- AFE2 Only: AFE2 is used, only the selected AFE starts to acquire data.
- AFE1 + AFE2, config independently: both AFEs are used, relevant configurations are set independently, no restrictions are applied.
- AFE1 + AFE2, config equally: both AFEs are used, relevant configurations are set equally, the AFE2 controls become inactive (read-only) and get assigned the same values that are selected in the corresponding AFE1 controls. This option applies for the settings that influence measurement timing (sequencer, auxiliary measurement selection, AFE resolution, etc.). This option does not apply for analog data path settings (gain, etc.), i.e., AFE2 is configurable for those parameters.
- Step Response: This option affects multiple configurations with the goal to achieve an AOUT step response time of less than 1ms and an IO-Link Step Response Time of less than 2ms<sup>1</sup>. Refer to the ZSSC3286 Datasheet document for details on timings with SM+/SM- configuration (Reference 3). Only one AFE is used and starts to acquire data (selectable via drop-down list “Selected AFE”). The following restrictions for the used AFE are applied:
  - Sequencer set to “SM+ AUX\_i”
  - in Configure tab, sub tab “AFE”, sub tab “Bridge”: “AdcReso” limited to 15bit, “SetTime” limited to 20μs
  - in Diagnostic tab, sub tab “Sensor/AFE”: Temperature Channel open measurements are limited to >100kΩ, Cbr and Cts are limited to 1nF
  - in tab “Configure”, sub tab “Filter”: Filter is disabled on all channels since it directly delays step response.

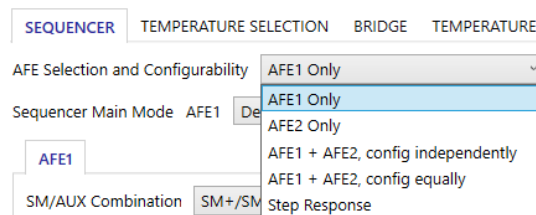

Figure 22. AFE Selection and Configurability

Every configuration field in the Sequencer tab of the GUI must have a value to be able to update NVM. If values are missing, a warning message is displayed (Figure 23) and if another tab is selected, incomplete settings will be lost.

**Not all fields for this configuration have values**

Figure 23. Sequencer Error Message

<sup>1</sup> Response time is based on calculations and measurements of code execution. No statistical validation by measurement done.

3.3.1.1.2. Sequencer Main Mode

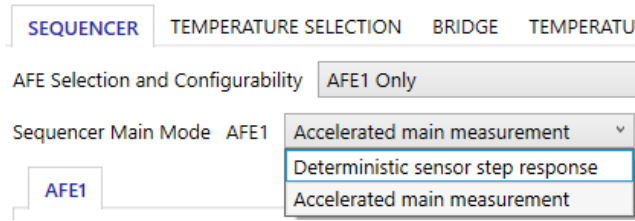

Figure 24. Sequencer Main Mode

The Sequencer Main Mode option (Figure 24) allows to configure the following options:

**Deterministic sensor step response**

For an application with fast, deterministic step response, the SM/AUX allowed the following combinations Figure 25.

- SM+/SM-/AUX<sub>i</sub>: Sensor measurement, inverted measurement, and auxiliary measurement
- SM-/SM+/AUX<sub>i</sub>: Inverted sensor measurement, sensor measurement and auxiliary measurement
- SM+/AUX<sub>i</sub>: Sensor measurement and auxiliary measurement (Auto-Zero)

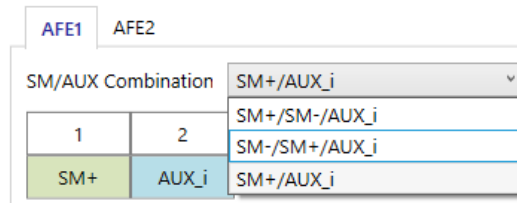

Figure 25. SM/AUX Combinations for Deterministic Sensor Step Response

**Note:** SM+ and SM- sequence can be exchanged yielding to the same result (Figure 26).

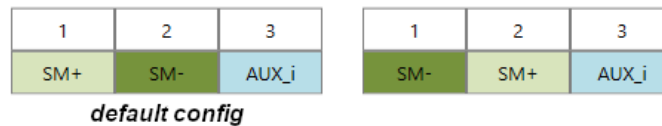

Figure 26. SM+/SM- Exchange

Within the auxiliary measurement vector, one auto-zero sensor measurement (AZS) can be configured (Figure 27). Thus, the inverted sensor measurement is not needed.

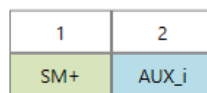

Figure 27. SM+ with Auto-Zero Sensor Measurement

The number of AUX measurements executed in one measurement sequence can be set to values between 1 and 7. Between two sequences, an Idle Time of up to 10ms can be configured (Figure 28).

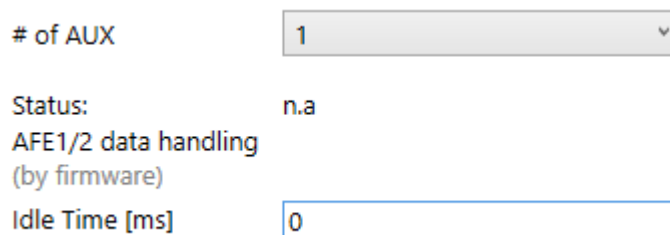
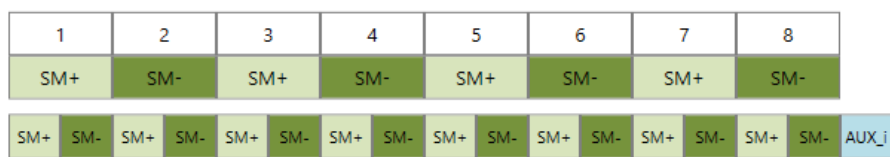

Figure 28. Number of AUX measurements and Idle Time

### Accelerated main measurement

This measurement scheme (Figure 29) is faster than the “Deterministic sensor step response” by significantly reducing the number of AUX measurements per SM measurement.



**Figure 29. Accelerated Main Measurement**

The possible sensor measurement combinations in the following (Figure 30):

- SM+/SM-: SM+ and SM- are processed to carry out internal offset compensation, AUX\_AZ is not active.
- SM+ with AUX\_AZ: SM+ and AUX\_AZ are processed to carry out internal offset compensation, AUX\_AZ is active.
- SM+ without AUX\_AZ: SM+ only without internal offset compensation, AUX\_AZ is not active.

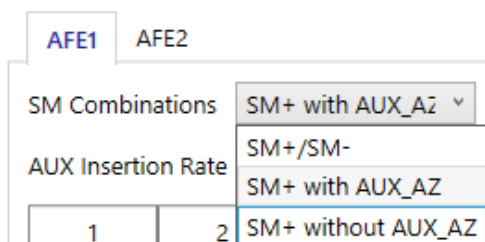

**Figure 30. SM/AUX Combinations for Accelerated Main Measurement**

The AUX Insertion Rate defines at which point of the measurement sequence an auxiliary measurement is performed. The auxiliary measurement can be placed after 2, 4, or 8 measurements (each consisting of 4 pairs of SM+/-), see Figure 31.

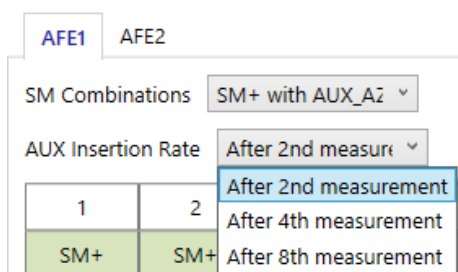

**Figure 31. Auxiliary Insertion Rate**

According to the selection done in the SM combination, the auxiliary measurement can also happen after a sequence of 16/32/64 SM+ measurements and with or without an additional AZ measurement (Figure 32).

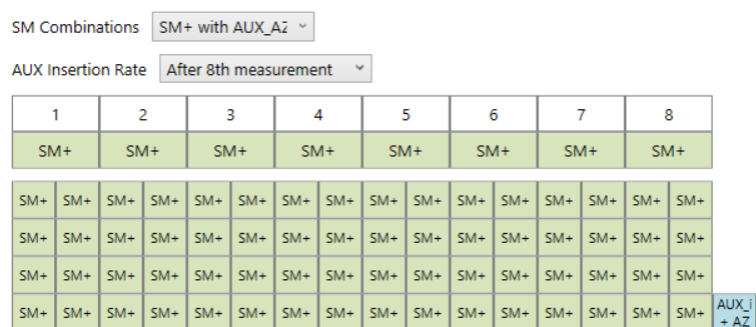

**Figure 32. Auxiliary Insertion Rate: SM+AUX\_AZ after the Eighth Measurement**

### 3.3.1.2. Temperature Selection Tab

Four physical temperature sensors are available:

- 1 internal temperature sensor: PTAT
- 3 external temperature sensors: T1, T2, T3

Each physical temperature sensor can be assigned to each of the 3 logical temperature channels (Temp Ch1/2/3). An overview of this tab is provided in Figure 33.

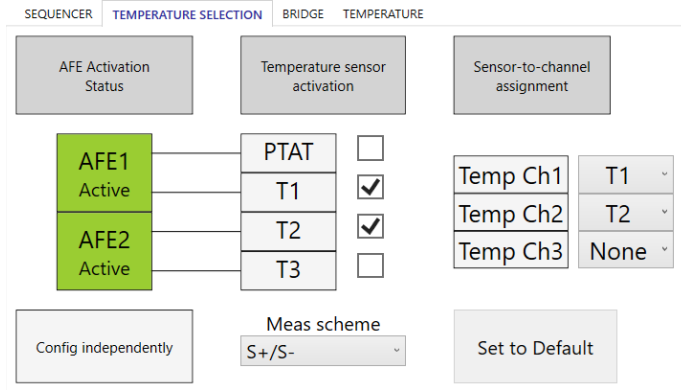

Figure 33. Temperature Selection Overview

This tab provides an overall view of the status of the Analog Front Ends, of the selectable temperature transducer(s), and of the association of the active temperature transducer(s) to one or more of the 3 logical temperature channels available.

#### 3.3.1.2.1. Channel Data Paths

A simplified, high-level description of the data paths for the Main sensor channels 1/2/3 and Temperature channels 1/2/3 is provided in Figure 34.

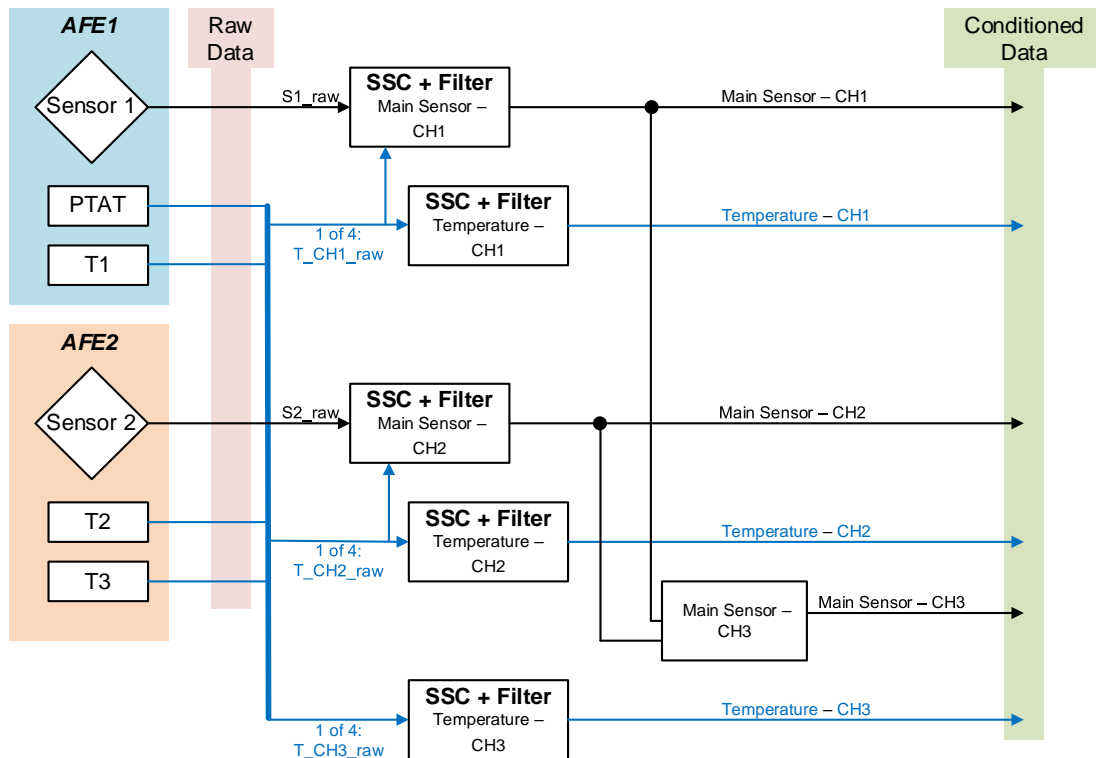

Figure 34. Acquired Data Stream Overview

### 3.3.1.2.2. AFE Status

Figure 35 displays the status of each AFE. A green color indicates that the AFE is active.

The AFE activation control is handled by the “Sequencer” tab, through the selection of the preferred option as displayed in Figure 22. If both AFEs are active, the GUI displays if they are configured equally or independently.

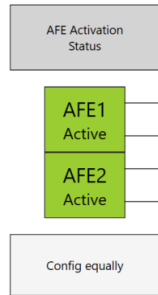

Figure 35. AFE Status

### 3.3.1.2.3. Temperature Sensor

Enable the relevant selection box to make one or more input temperature transducers active (Figure 36).

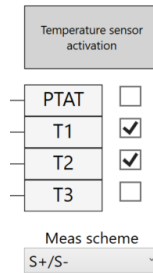

Figure 36. Temperature Sensor Activation

AFE1 processes, when activated, the PTAT and/or T1. AFE2 processes, when activated, the T2 and/or T3. The “Meas scheme” drop-down list allows to choose between the acquisitions of S+/S- or S+ only.

**Note:** The selected activations are automatically changed in the GUI if the configuration chosen in the sequencer is modified (refer to Figure 22). This allows to keep consistency in the device configuration.

### 3.3.1.2.4. Channel Assignment

Assign the activated temperature sensor to the Temperature channels (1/2/3) by the drop-down lists, see Figure 37. “Set to Default” button returns channel assignment to factory default values.

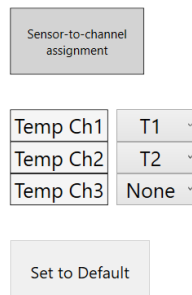

Figure 37. Sensor to Channel Assignment

**Note:** The channel assignments selected by the user may be automatically changed in the GUI in case the user afterwards modifies the configuration chosen in the sequencer (refer to Figure 22). This allows to keep consistency in the device configuration.

### 3.3.1.3. Bridge Tab

The Bridge tab is structured according to the following:

- The settings in the “Parameters” section are the only ones that are saved in the device configuration NVM.
- Data input in the “Sensor Values” section is used for the “Internals” values calculations along with the selected “Parameters”.
- The “Meas Config” selection affects only the “Internals” calculations and the graphs display.

#### 3.3.1.3.1. Bridge Configurations

Through the “Mode” drop-down list in the “Parameters” section, the GUI offers 4 options for supplying the transducer wired to the ZSSC3286, allowing the resistive bridge to be supplied by/through:

- Voltage: internal voltage supply (VDDA, Reference 3) (Figure 38).

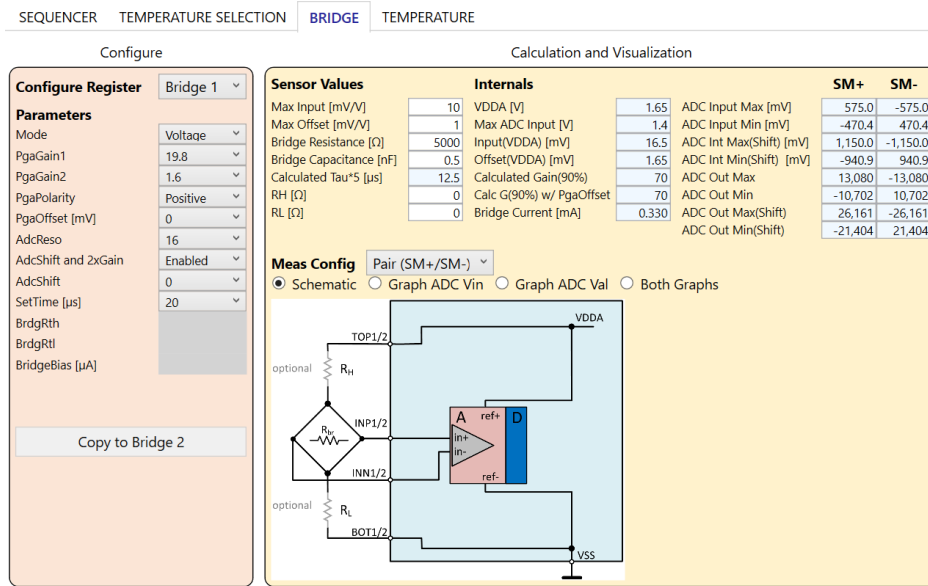

Figure 38. Voltage Mode

- Resistor: Internal voltage supply (VDDA, Reference 3) with configurable internal series resistors (Figure 39).

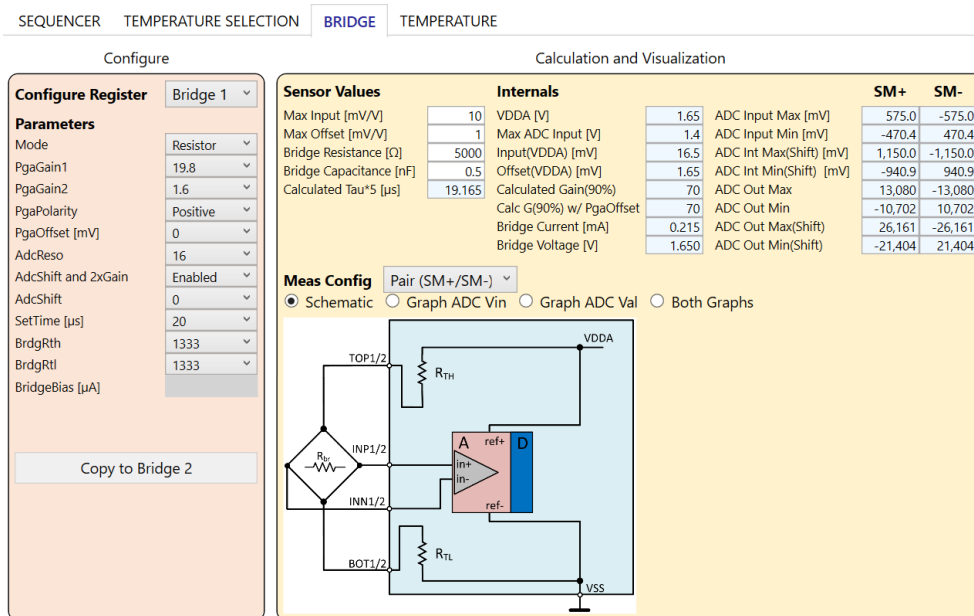

Figure 39. Resistor Mode



- Current: Configurable internal current source with configurable internal series resistor (Figure 40).

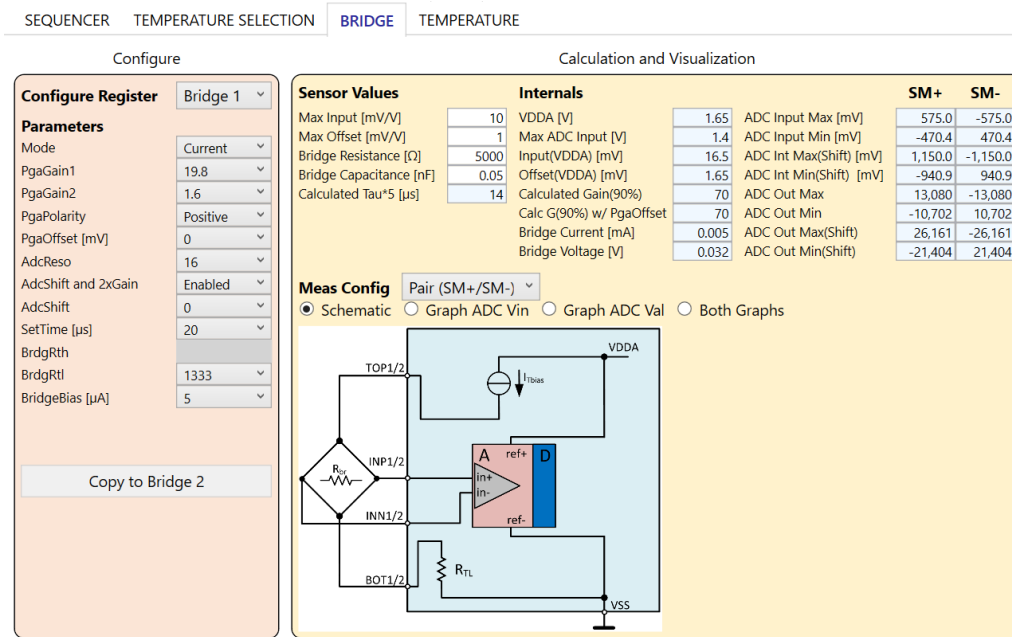

Figure 40. Current Mode

- Thermopile: The device acquires the voltage signal generated by a thermopile (Figure 41).

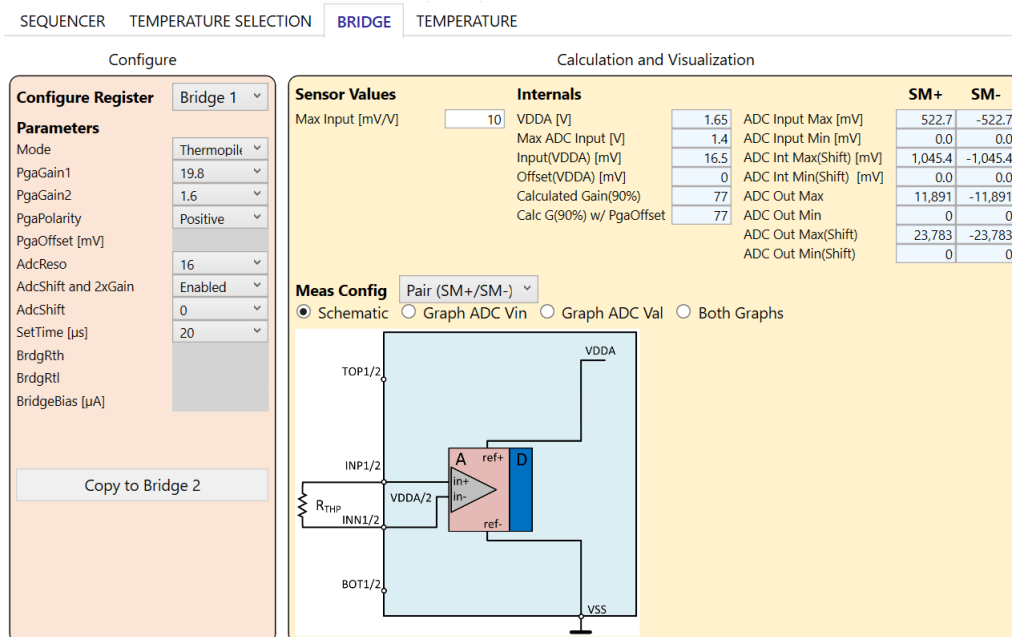

Figure 41. Thermopile Mode

### 3.3.1.3.2. Configure Register

To configure an Analog Front End, select it from the “Configure Register” drop-down list and set the relevant values in the Parameters section.

To duplicate an already defined configuration, click the “Copy to Bridge” button (Figure 42).

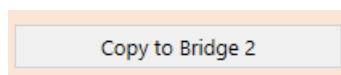

Figure 42. Configure Register

3.3.1.3.3. Meas Config

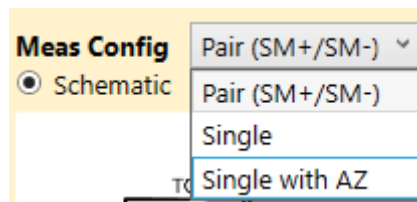

Figure 43. Meas Config Menu

The “Meas Config” menu affects the internal calculations and graphs only (Figure 43), the drop-down list has the following options:

- Pair (SM+/SM-): a pair of measurements, i.e. the SM+ and SM- readings (Figure 43)
- Single: single measurement (Figure 44)
  - SM+
  - SM-
  - AZ

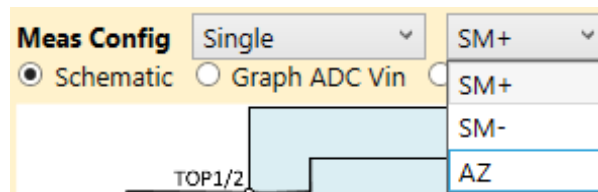

Figure 44. Meas Config: Single

- Single with AZ: single measurement with AZ (Figure 45)
  - SM+
  - SM-
  - AZ

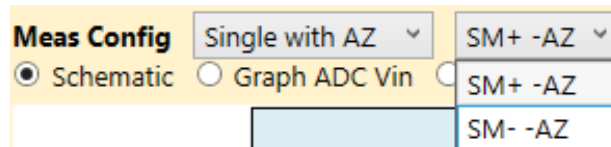

Figure 45. Meas Config: Single AZ

3.3.1.3.4. Sensor Values

The “Sensor Values” section (Figure 46) allows the user to enter the input transducer characteristics for performing the calculations displayed in Figure 49.

Sensor Values	
Max Input [mV/V]	10
Max Offset [mV/V]	1
Bridge Resistance [ $\Omega$ ]	10000
Bridge Capacitance [nF]	0
Calculated Tau*5 [ $\mu$ s]	0
RH [ $\Omega$ ]	0
RL [ $\Omega$ ]	0

Figure 46. Bridge – Sensor Values

The GUI SW calculates the Tau time constant (Resistance x Capacitance) according to the inputs provided.

3.3.1.3.5. Parameters

The Parameters section (Figure 47) defines the type of the transducer supply, the behavior of the analog signal path, and the ADC configuration. Specific parameters values enable or disable the availability of a set of additional parameters and the relevant list of available values.

The reference schematic in Figure 48 is dynamically updated according to the “Mode” selection, see section 3.3.1.4.2 for details on different modes.

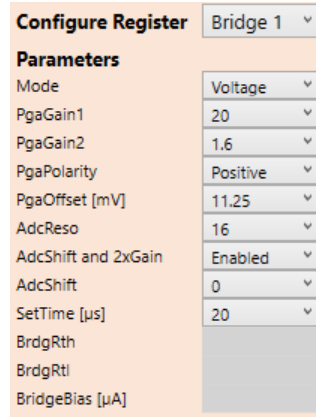

Figure 47. Bridge – Parameters

The following parameters can be set:

- Mode: defines the type of supply scheme of the connected transducer (section 3.3.1.3.1)
- PgaGain1: PGA gain stage 1 value
- PgaGain2: PGA gain stage 2 value
- PgaPolarity: Polarity inversion of the PGA input signal
- PgaOffset [mv]: PGA offset value (in mV)
- AdcReso: ADC resolution
- AdcShift and 2xGain: enables/disables the internal ADC 2x gain and internal ADC offset shift
- AdcShift: ADC offset shift value
- SetTime [us]: Bridge settling time (μs)

The following parameters are available if “Current” or “Resistor” modes are selected:

- BrdgRth: internal bridge resistor value (Ohm) upper side (RTH)
- BrdgRtl: internal bridge resistor value (Ohm) lower side (RTL)
- BridgeBias [uA]: current level of transducer current driver (ITbias)

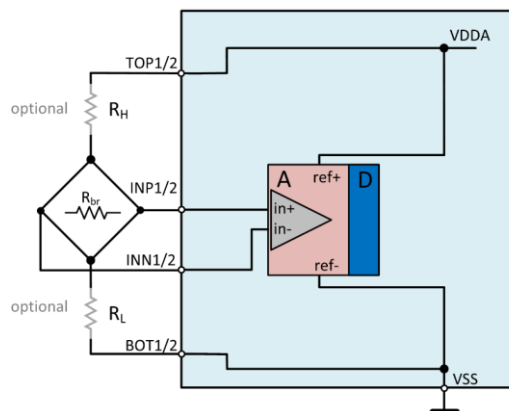

Figure 48. Mode Voltage Schematic

3.3.1.3.6. Internals

The “Internals” section (Figure 49) displays values of specific electrical parameters that are built into the device and shows the calculated parameters depending on the values set as per sections 3.3.1.3.3, 3.3.1.3.4 and 3.3.1.3.5.

Internals			SM+	SM-
VDDA [V]	1.65	ADC Input Max [mV]	676.8	-676.8
Max ADC Input [V]	1.4	ADC Input Min [mV]	148.8	-148.8
Input(VDDA) [mV]	8.25	ADC Int Max(Shift) [mV]	1,353.6	-1,353.6
Offset(VDDA) [mV]	1.65	ADC Int Min(Shift) [mV]	297.6	-297.6
Calculated Gain(90%)	129	ADC Out Max	15,397	-15,397
Calculated Offset(90%)	60	ADC Out Min	3,385	-3,385
Bridge Current [mA]	0.330	ADC Out Max(Shift)	30,793	-30,793
		ADC Out Min(Shift)	6,770	-6,770

Figure 49. Internals Example

The following values are displayed:

- VDDA: analog supply typical level (silicon defined)
- Max ADC Input [V]: the maximum ADC input level (defined by silicon)
- Input(VDDA) [mV]: input pin level (VDDA supply) in mV
- Offset(VDDA) [mV]: offset input pin level (VDDA supply) in mV
- Calculated Gain(90%): suggested Gain setting to reach 90% FS
- Calculated Offset(90%): suggested offset setting to reach 90% FS
- Bridge Current [mA]: current on the resistive transducer
- ADC Input Max [mV]: ADC maximum input (input multiplied by Gain)
- ADC Input Min [mV]: ADC minimum input (input multiplied by Gain)
- ADC Input Max(Shift) [mV]: ADC maximum input (input multiplied by Gain and including shift)
- ADC Input Min(Shift) [mV]: ADC minimum input (input multiplied by Gain and including shift)
- ADC Out Max: ADC maximum output (counts)
- ADC Out Min: ADC minimum output (counts)
- ADC Out Max(Shift): ADC maximum output with ADC internal shift and 2x gain (counts)
- ADC Out Min(Shift): ADC minimum output with ADC internal shift and 2x gain (counts)

Out of range parameters or input values are highlighted in red (Figure 50).

Internals			SM+	SM-
VDDA [V]	1.65	ADC Input Max [mV]	1,468.8	-1,468.8
Max ADC Input [V]	1.4	ADC Input Min [mV]	-643.2	643.2
Input(VDDA) [mV]	33	ADC Int Max(Shift) [mV]	2,937.6	-2,937.6
Offset(VDDA) [mV]	1.65	ADC Int Min(Shift) [mV]	-1,286.4	1,286.4
Calculated Gain(90%)	37	ADC Out Max	33,414	-33,414
Calculated Offset(90%)	28	ADC Out Min	-14,632	14,632
Bridge Current [mA]	0.165	ADC Out Max(Shift)	66,827	-66,827
		ADC Out Min(Shift)	-29,264	29,264

Figure 50. Internals Out of Range

### 3.3.1.3.7. Schematic and Graphs

Select Schematic, Graph ADC Vin, Graph ADC Val, or Both Graphs (Figure 51) to switch view between the reference circuit schematic, the input to ADC Voltage transfer characteristic graph, the ADC input voltage to ADC counts transfer characteristic, and a combined view of both graphs (Figure 52).

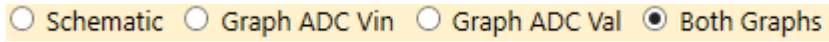

Figure 51. Schematic and Graphs Selection

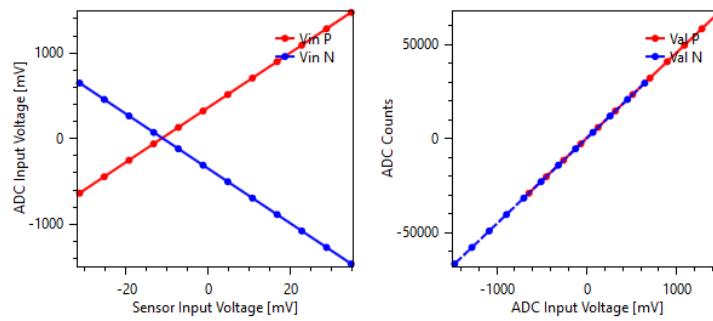

Figure 52. Both Graphs

### 3.3.1.3.8. Bridge in Step Response Configuration

If “Step Response” configuration is selected (section 3.3.1.1.1), parameters of the chosen Bridge are fixed as shown in Figure 53. Parameters of the other Bridge stay configurable.

Configure
Calculation and Visualization

**Configure Register** Bridge 1

**Parameters**

Mode: Voltage

PgaGain1: 19.8

PgaGain2: 1.8

PgaPolarity: Positive

PgaOffset [mV]:

AdcReso: 15

AdcShift and 2xGain:

AdcShift:

SetTime [μs]: 20

BrdgRth:

BrdgRtl:

BridgeBias [μA]:

Copy to Bridge 2

**Sensor Values**

Max Input [mV/V]	10
Max Offset [mV/V]	1
Bridge Resistance [Ω]	4000
Bridge Capacitance [nF]	0.5
Calculated Tau*5 [μs]	10
RH [Ω]	0
RL [Ω]	0

**Internals**

VDDA [V]	1.65
Max ADC Input [V]	1.4
Input(VDDA) [mV]	16.5
Offset(VDDA) [mV]	1.65
Calculated Gain(90%)	70
Calc G(90%) w/ PgaOffset	70
Bridge Current [mA]	0.413

SM+	SM-
ADC Input Max [mV]	646.9
ADC Input Min [mV]	-529.3
ADC Int Max(Shift) [mV]	0.0
ADC Int Min(Shift) [mV]	0.0
ADC Out Max	7,365
ADC Out Min	-6,026
ADC Out Max(Shift)	0
ADC Out Min(Shift)	0

**Meas Config** Pair (SM+/SM-)

Schematic  Graph ADC Vin  Graph ADC Val  Both Graphs

Figure 53. Step Response Configuration for Bridge 1

### 3.3.1.4. Temperature Tab

The Temperature tab is structured according to the following scheme:

- Only the settings in the “Parameters” section are saved in the device configuration NVM.
- Data input in the “Sensor Values” section is used for the “Internals” values calculations along with the selected “Parameters”.
- The “Meas Config” selection affects only the “Internals” calculations and the graphs display.

### 3.3.1.4.1. Temp Configurations

Through the “Mode” drop-down list in the Parameters section, the GUI offers the following options for supplying the temperature transducer connected to the ZSSC3286 pins:

- Sink, Internal Bias: The transducer (Diode/NTC/PTC) is supplied by an internal voltage source or by an internal configurable current source tied to the VSS rail (GND) (Figure 54).

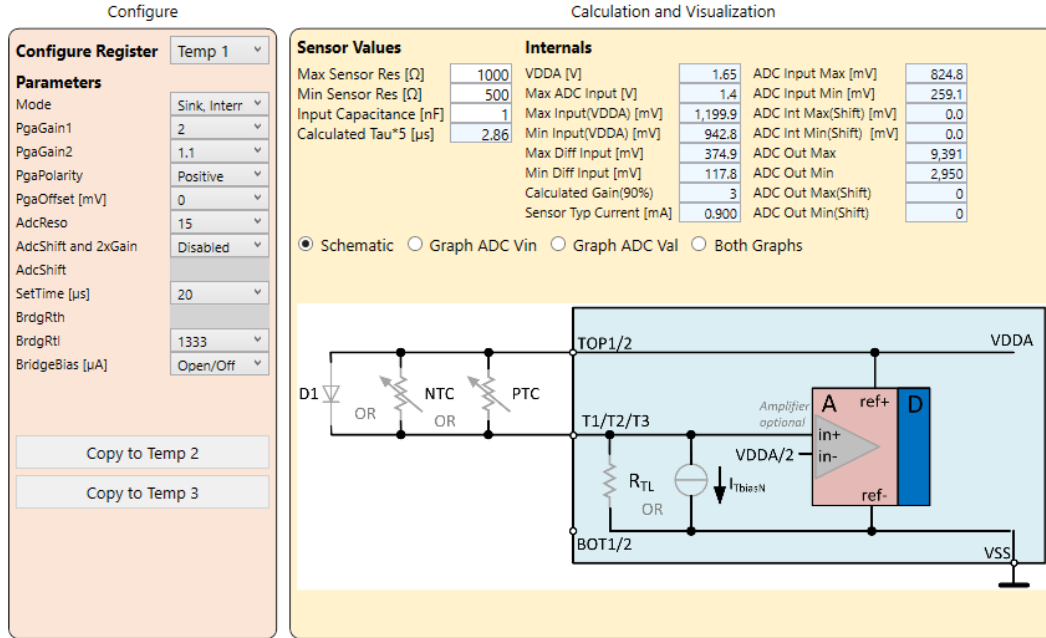

Figure 54. Temp – Mode Sink Internal Bias

- Source, Internal Bias: The transducer (Diode/NTC/PTC) is supplied by an internal voltage source or by an internal configurable current source tied to the VDDA rail (Reference 3).

Note: This mode is used in this document for description/example purposes for the Temp tab, selecting other modes returns different schematic, graphs, and parameters enabling/disabling options (Figure 55).

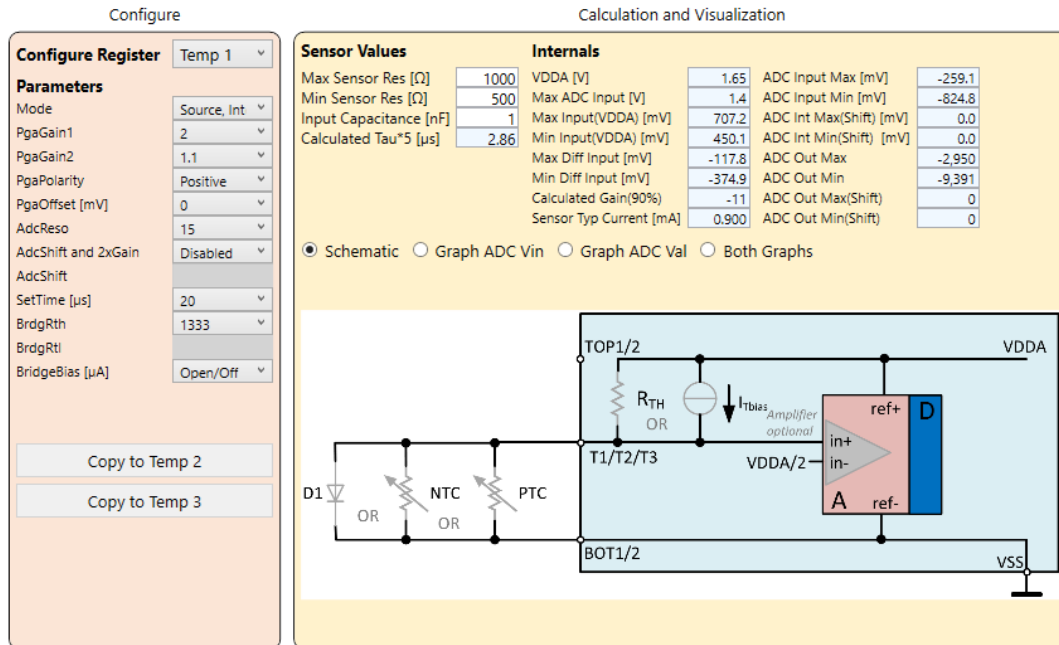

Figure 55. Temp – Mode Source Internal Bias

- External Bias: The transducer is supplied with a voltage source from the following possible configuration:
  - The diode/NTC/PTC transducer is supplied through an external resistor tied to VDDA (Reference 3). This is active when the “External RL” (selectable in the Sensor Values section) is not set to “open” or “0” (Figure 56).

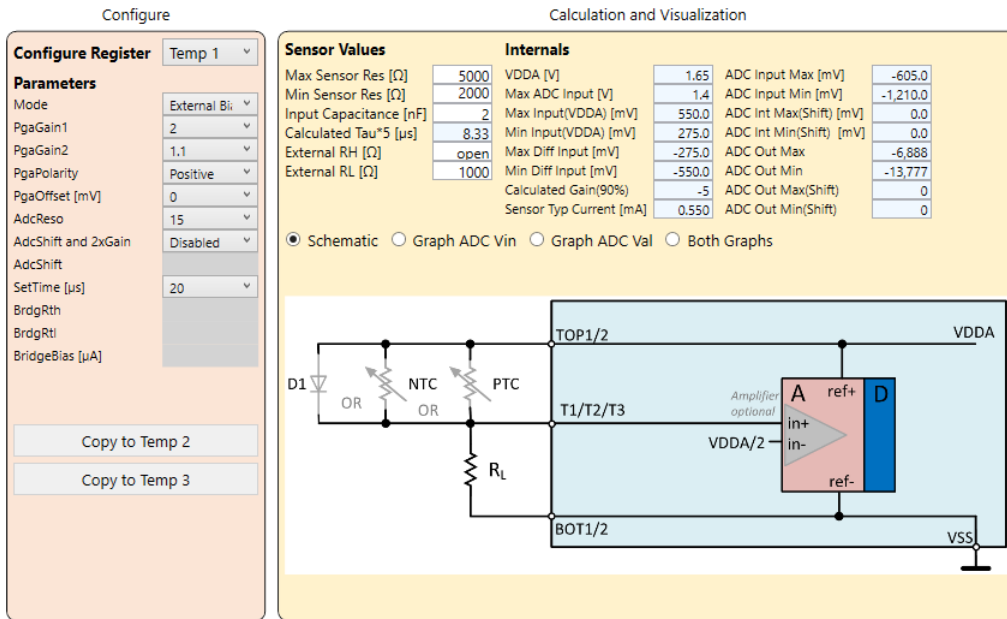

Figure 56. Mode Source External Bias Low

- The diode/NTC/PTC transducer is supplied through an external resistor tied to VSS (GND) when the “External RH” (selectable in the Sensor Values section) is not set to “open” or “0” (Figure 57).

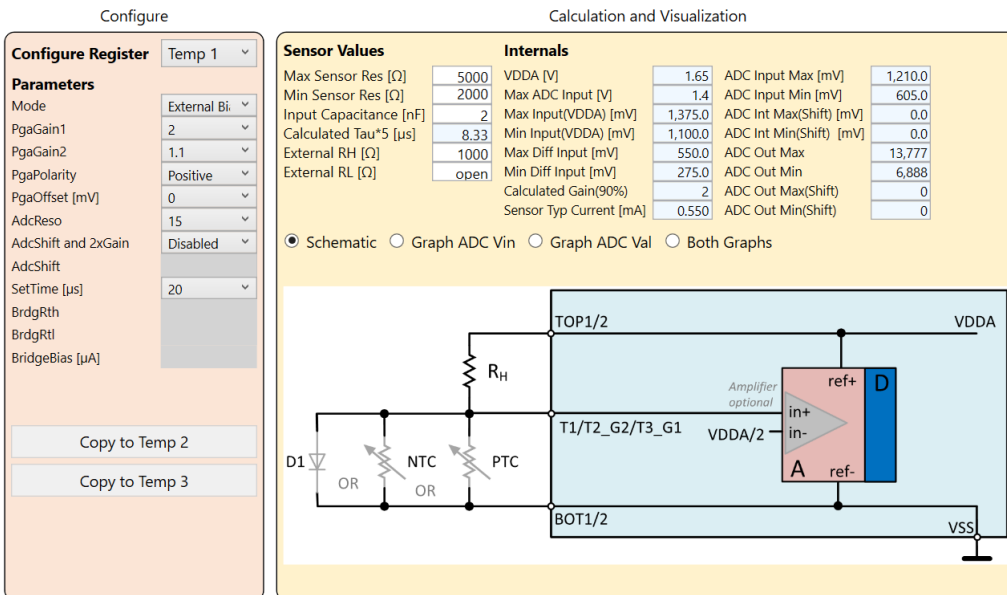

Figure 57. Mode Source External Bias High

To select between the options, put a non-zero value in the “External RH” or “External RL” (see Figure 58).

External RH [Ω]	1
External RL [Ω]	open

Figure 58. External RH, RL

- Bridge, Internal Bias: The resistive bridge (used for the main measurement) is supplied by an internal voltage source or by an internal configurable current source tied to VDDA (Reference 3) (Figure 59).

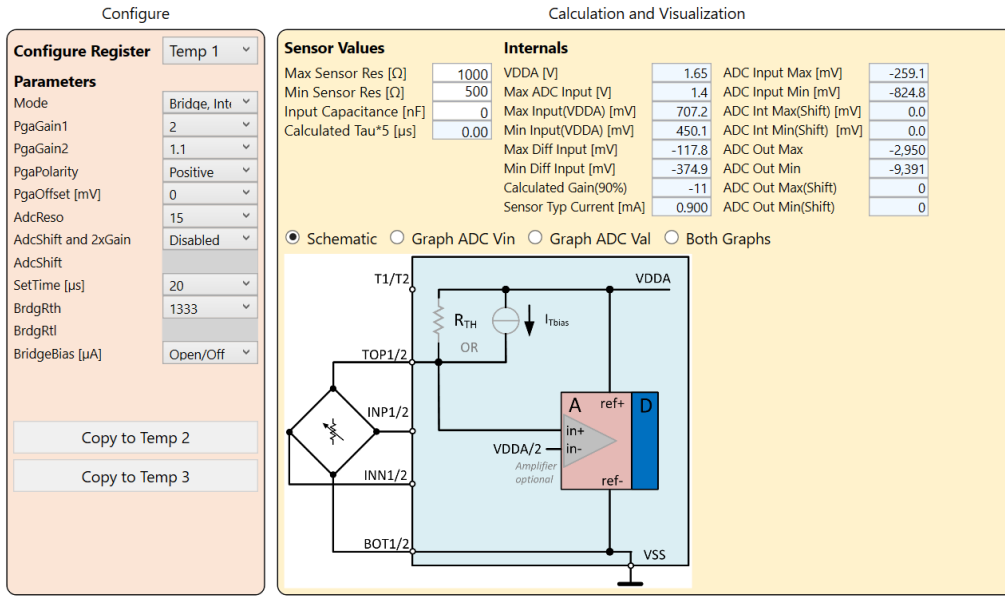

Figure 59. Mode Bridge Internal Bias

- Bridge, External Bias: The resistive bridge (used for the main measurement), is supplied by an internal voltage source through an external resistor (selectable by the “External RH”) (Figure 60).

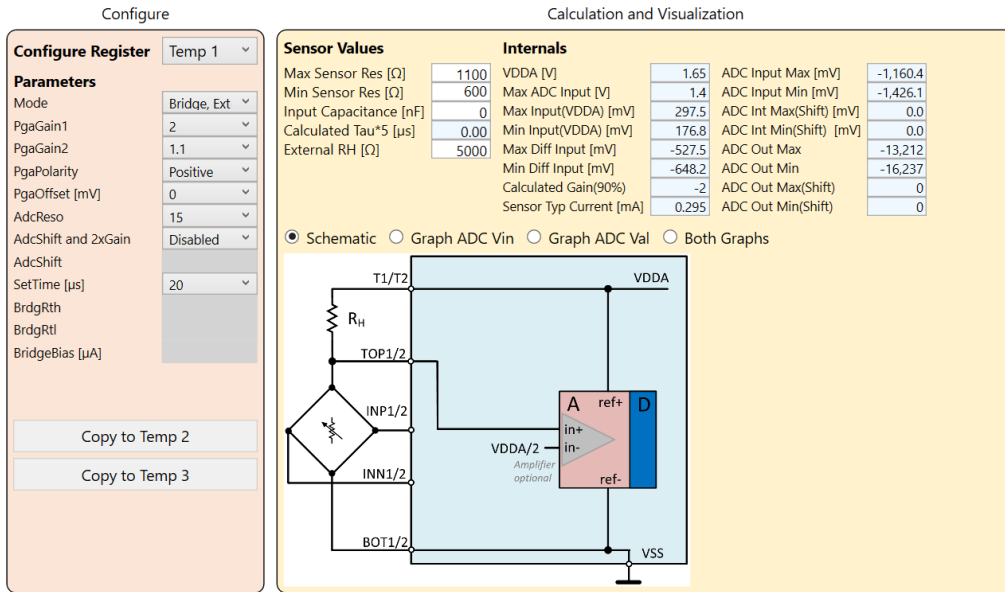

Figure 60. Mode Bridge External Bias



- Bridge, Differential: The resistive bridge (used for the main measurement) is supplied through an internal configurable resistor tied to VDDA (RTH) and to VSS (RTL) (Figure 61).

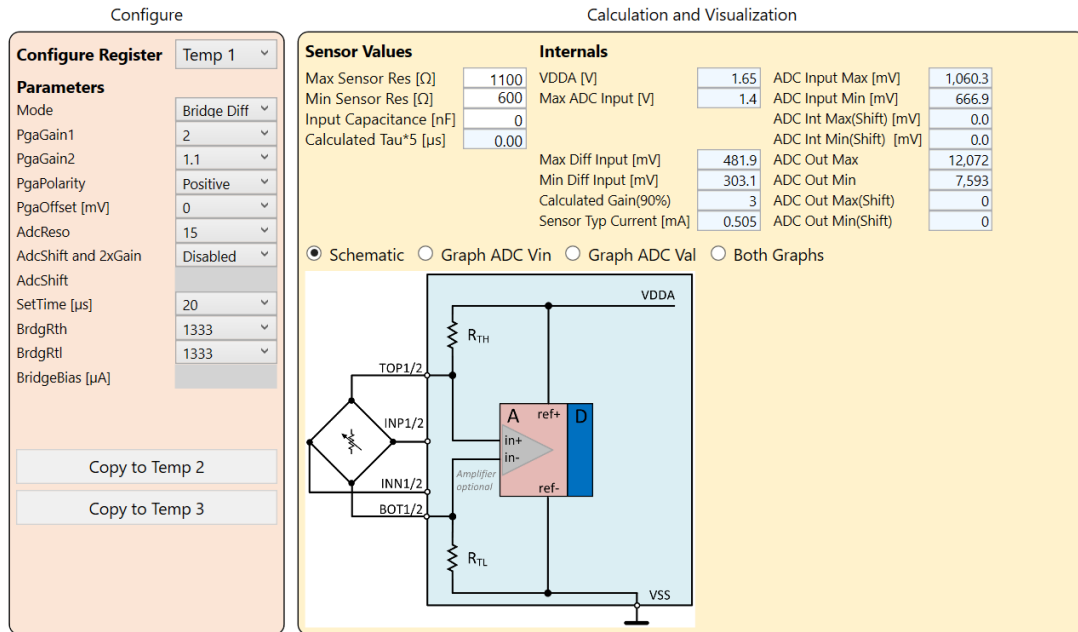

Figure 61. Mode Bridge Differential

### 3.3.1.4.2. Configure Register

To configure an external transducer input or the device internal temperature transducer input, select Temp 1, Temp 2, Temp 3, or PTAT from the “Configure Register” drop-down list and set the relevant values in the Parameters section (Figure 62).

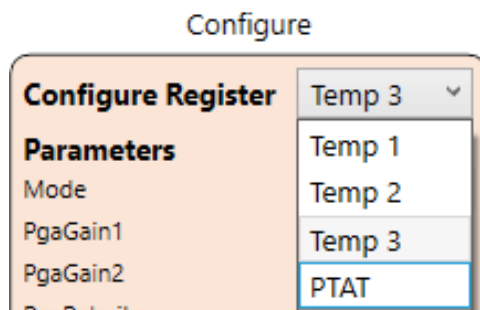

Figure 62. Configure Register

To duplicate an already defined configuration to another temperature sensor, click the “Copy to Temp 1/2/3” button (Figure 63).

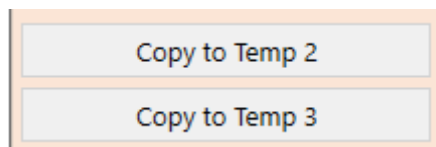

Figure 63. Copy to Temp

3.3.1.4.3. Sensor Values

This section (Figure 64) allows the user to enter the input transducer characteristics for performing the calculations displayed in Figure 67.

Sensor Values	
Max Sensor Res [ $\Omega$ ]	1100
Min Sensor Res [ $\Omega$ ]	600
Sensor Typ Resistance [ $\Omega$ ]	750
Input Capacitance [nF]	0
Calculated Tau*5 [ $\mu$ s]	0.00

Figure 64. Temp– Sensor Values

The GUI calculates the Tau (Resistance x Capacitance) according to the inputs provided.

3.3.1.4.4. Parameters

The “Parameters” section (see Figure 65) defines the type of the transducer supply, the behavior of the analog signal path, and the ADC configuration. Specific parameters values enable or disable the availability of a set of additional parameters and the relevant list of available values.

The reference schematic in Figure 66 is dynamically updated according to the “Mode” selection, see section 3.3.1.4.1 for details on different modes.

Parameters	
Mode	Bridge Diff ▾
PgaGain1	2 ▾
PgaGain2	1.1 ▾
PgaPolarity	Positive ▾
PgaOffset [mV]	0 ▾
AdcReso	15 ▾
AdcShift and 2xGain	Disabled ▾
AdcShift	
SetTime [ $\mu$ s]	20 ▾
BrdgRth	1333 ▾
BrdgRtl	1333 ▾
BridgeBias [ $\mu$ A]	

Figure 65. Parameters

The following parameters can be set:

- Mode: defines the type of supply scheme of the connected transducer (section 3.3.1.4.1)
- PgaGain1: PGA gain stage 1 value
- PgaGain2: PGA gain stage 2 value
- PgaPolarity: Polarity inversion of the PGA input signal
- PgaOffset [mv]: PGA offset value (in mV)
- AdcReso: ADC resolution
- AdcShift and 2xGain: enables/disables the internal ADC 2x gain and internal ADC offset shift
- AdcShift: ADC offset shift value
- SetTime [ $\mu$ s]: Bridge settling time ( $\mu$ s)
- BrdgRth: internal bridge resistor value (Ohm) upper side (RTH), this field is greyed out in the example configuration)

- BrdgRtl: internal bridge resistor value (Ohm) lower side (RTL)
- BridgeBias [μA]: current level of transducer current driver (ITbias)

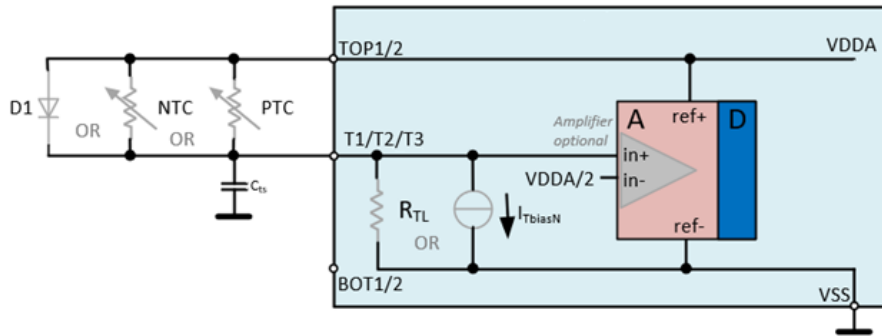

Figure 66. Temp – Schematic

### 3.3.1.4.5. Internals

The Internals section (Figure 67) displays values of specific electrical parameters that are built into the device and shows the calculated parameters depending on the values set as per sections 3.3.1.4.1, 3.3.1.4.2, 3.3.1.4.3 and 3.3.1.4.4.

Internals			
VDDA [V]	1.65	ADC Input Max [mV]	-347.6
Max ADC Input [V]	1.4	ADC Input Min [mV]	-1,376.5
Max Input(VDDA) [mV]	746.0	ADC Int Max(Shift) [mV]	0.0
Min Input(VDDA) [mV]	512.2	ADC Int Min(Shift) [mV]	0.0
Max Diff Input [mV]	-79.0	ADC Out Max	-3,958
Min Diff Input [mV]	-312.8	ADC Out Min	-15,672
Calculated Gain(90%)	-16	ADC Out Max(Shift)	0
Sensor Typ Current [mA]	0.854	ADC Out Min(Shift)	0

Figure 67. Internals

The following values are displayed:

- VDDA: analog supply typical level (silicon defined)
- Max ADC Input [V]: the maximum ADC input level (silicon defined)
- Max Input(VDDA) [mV]: maximum input pin level (referred to VDDA) in mV
- Min Input(VDDA) [mV]: minimum input pin level (referred to VDDA) in mV
- Max Diff Input [mV]: maximum differential input (in mV) at input pins
- Min Diff Input [mV]: minimum differential input (in mV) at input pins
- Calculated Gain(90%): suggested Gain setting to reach 90% FS
- Sensor Typ Current [mA]: typical current on transducer element (mA)
- ADC Input Max [mV]: ADC maximum input (input multiplied by Gain)
- ADC Input Min [mV]: ADC minimum input (input multiplied by Gain)
- ADC Int Max(Shift) [mV]: ADC maximum input (input multiplied by Gain and including shift)
- ADC Int Min(Shift) [mV]: ADC minimum input (input multiplied by Gain and including shift)
- ADC Out Max: ADC maximum output (counts)
- ADC Out Min: ADC minimum output (counts)
- ADC Out Max(Shift): ADC maximum output with ADC internal shift and 2x gain (counts)
- ADC Out Min(Shift): ADC minimum output with ADC internal shift and 2x gain (counts)

Out of range parameters or input values are highlighted in red (Figure 68).

Internals			
VDDA [V]	1.65	ADC Input Max [mV]	-521.4
Max ADC Input [V]	1.4	ADC Input Min [mV]	-2,064.8
Max Input(VDDA) [mV]	746.0	ADC Int Max(Shift) [mV]	0.0
Min Input(VDDA) [mV]	512.2	ADC Int Min(Shift) [mV]	0.0
Max Diff Input [mV]	-79.0	ADC Out Max	-5,937
Min Diff Input [mV]	-312.8	ADC Out Min	-23,509
Calculated Gain(90%)	-16	ADC Out Max(Shift)	0
Sensor Typ Current [mA]	0.854	ADC Out Min(Shift)	0

Figure 68. Internals Out of Range

### 3.3.1.4.6. Schematic and Graphs

Select Schematic, Graph ADC Vin, Graph ADC Val, or Both Graphs (Figure 69) to switch view among the reference circuit schematic, the input to ADC Voltage transfer characteristic graph, the ADC input voltage to ADC counts transfer characteristic, and a combined view of both graphs (Figure 70).

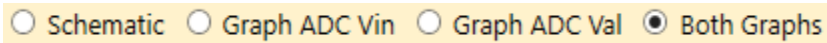

Figure 69. Schematic and Graphs Selection

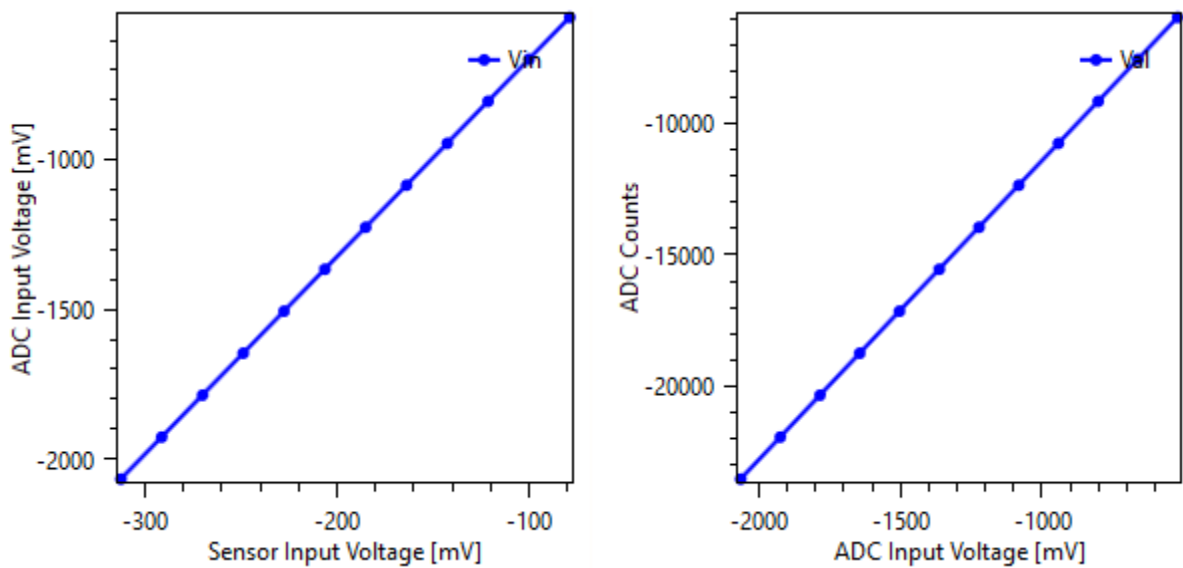

Figure 70. Combined Graphs

### 3.3.1.4.7. Configuration of the Kit for SRB Pt1000 reading

TCh1 is preconfigured to allow the use of the Pt1000 present on the SRB as temperature transducer (Figure 71). Ensure the following hardware settings are in place: ZSSC3286 EVB J7 and J8 placed; SRB SW1 in the left position.

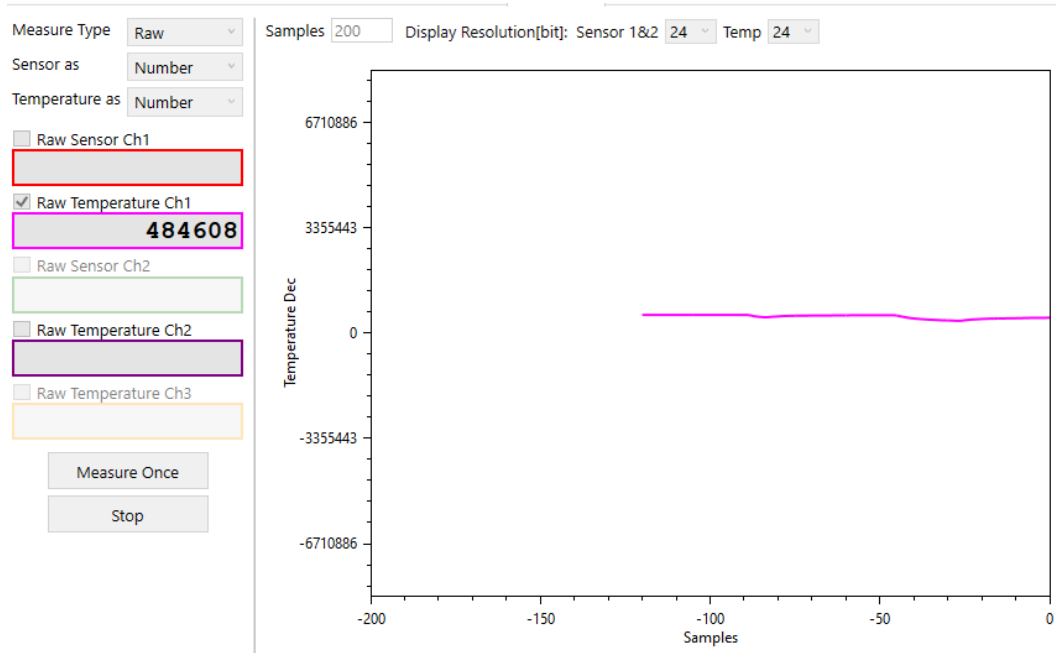

Figure 71. Pt1000 Measurements

For actual temperature measurement, Tch1 requires calibration (the default calibration coefficients are set to “0”, except for “TGain” being set to “1”).

### 3.3.2. TLC Tab

The Third Logic Channel (Figure 34) allows the processing of conditioned data from Sensor Channel 1 and Sensor Channel 2 according to the operation displayed in Figure 72.

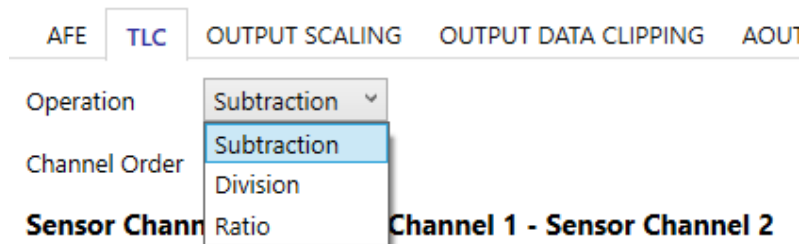

Figure 72. Third Logic Channel Operations

Select “Subtraction” or “Division” from the “Operation” drop-down list (Figure 72), and “CH1 op CH2” or “CH2 op CH1” from the “Channel Order” drop-down list (Figure 73).

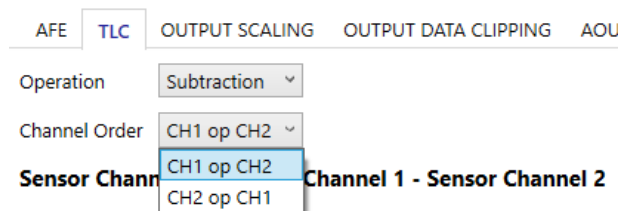

Figure 73. Third Logic Channel – Channel Order

The Third logic channel provides the user conditioned data only as there is no physical AFE associated with it. The relevant measurements are displayed in the Measure tab described in section 3.7.

Data provided by the ZSSC3286 is 4 bytes long so that the result of the division between the 2 sensor channels can be properly displayed.

The Third logic channel supports the following mathematical operations:

- Subtraction
  - The TLC supports *subtraction* operation  $ch3 = ch1 - ch2$ .
  - The TLC supports *subtraction* operation  $ch3 = ch2 - ch1$ .
- Division
  - The TLC supports *division* operation  $ch3 = ch1 / ch2$ .
  - The TLC supports *division* operation  $ch3 = ch2 / ch1$ .
  - A division by zero or small number is handled as a math saturation.
- Ratio
  - The TLC supports *ratio* operation, which is defined as following (pseudo code):

```

IF ch1 == ch2 THEN
    ch3 = 1
ELSE IF ch1 < ch2 THEN
    ch3 = ch1 / ch2
ELSE
    ch3 = 2 - (ch2 / ch1)
    
```

### 3.3.3. Output Scaling Tab

The output scaling functionality allows the linear re-scaling of a reduced input range to the full input range. The functionality is useful when the input range is reduced but changing the AFE settings or performing a new calibration to reach the full output range is not an option.

The functionality is available for the 2 main sensor channels (1 and 2) but not for the remaining channels (T1/2/3 and CH3).

The output scaling functionality acts downstream when the input is conditioned by the SSC math (section 3.3.1.2.1) and upstream when the application of the (IIR) has filtering function (section 3.3.6).

The Output scaling tab is displayed in Figure 74.

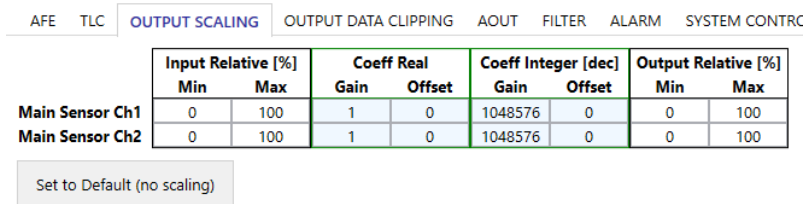

Figure 74. Output Scaling

The “Input Relative [%]” and “Output Relative [%]” fields are editable. The GUI calculates the “Offset” and “Gain” coefficients.

Click the “Set to Default (no scaling)” button to have the default input/output values (see Figure 75).

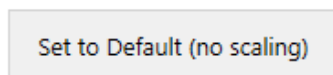
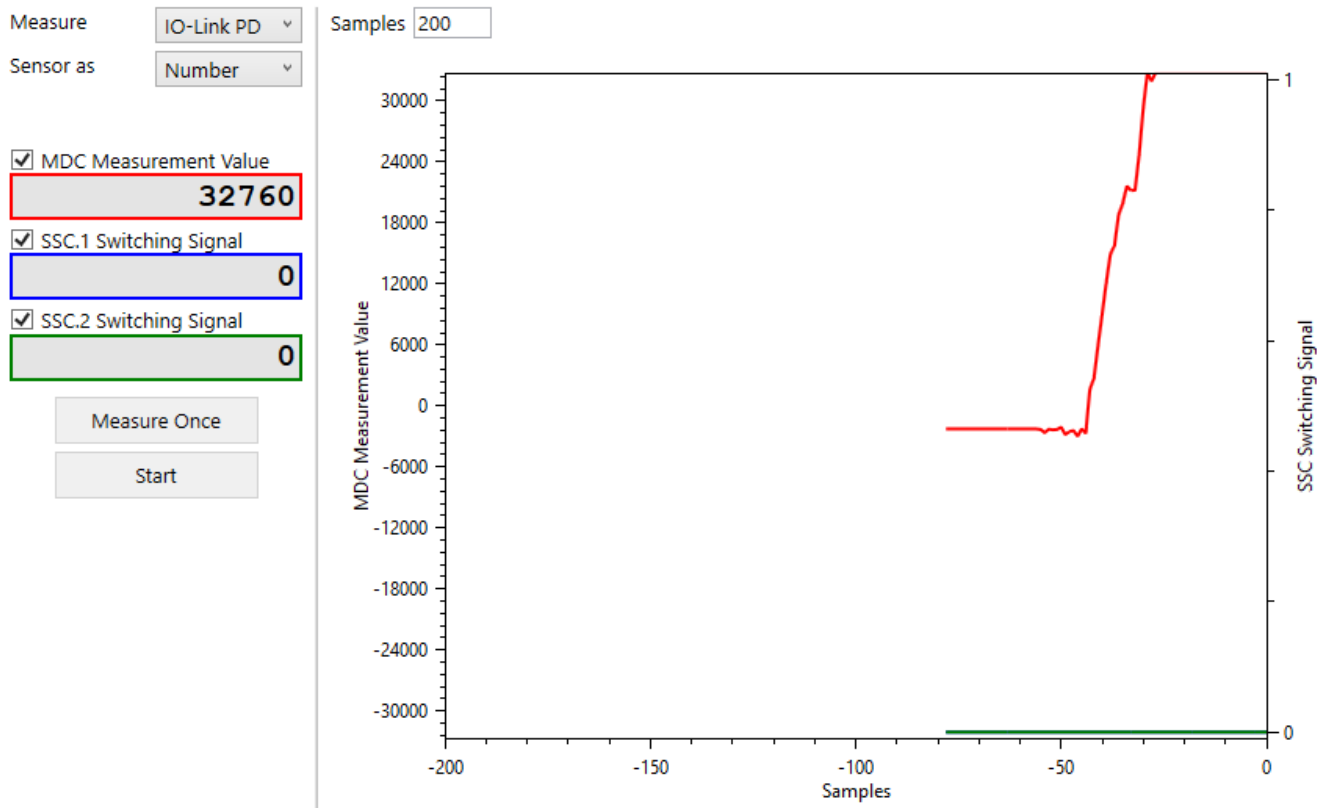

Figure 75. Back to Defaults

### Output Scaling Example

For this example, it is assumed that the actual input returning an output swing from 50% to 100% of the full scale (Figure 76).



**Figure 76. 50% to 100% Output**

In the example, main sensor Ch1 must return as full-scale output without changing calibration, AFE setup or SSP Scaling, only using the Output scaling. The current full-scale signal (%) and the output desired full-scale signal (%) input is set (Figure 77).

	Input Relative [%]		Coeff Real		Coeff Integer [dec]		Output Relative [%]	
	Min	Max	Gain	Offset	Gain	Offset	Min	Max
Main Sensor Ch1	50	100	2	-1	2097152	-1048576	0	100
Main Sensor Ch2	0	100	1	0	1048576	0	0	100

Set to Default (no scaling)

**Figure 77. Coefficients for 0% to 100% Output**

The GUI automatically calculates the scaling coefficients to be applied and displays them in the “Coeff Real” and “Coeff Integer [dec]” fields of Figure 77. To have the Output to operate from 0% to 100% full-scale, a memory write needs to be performed so that scaling coefficients are saved in NVM.

The measurements after applying the coefficients in Figure 77 return the expected swing as displayed in Figure 78.

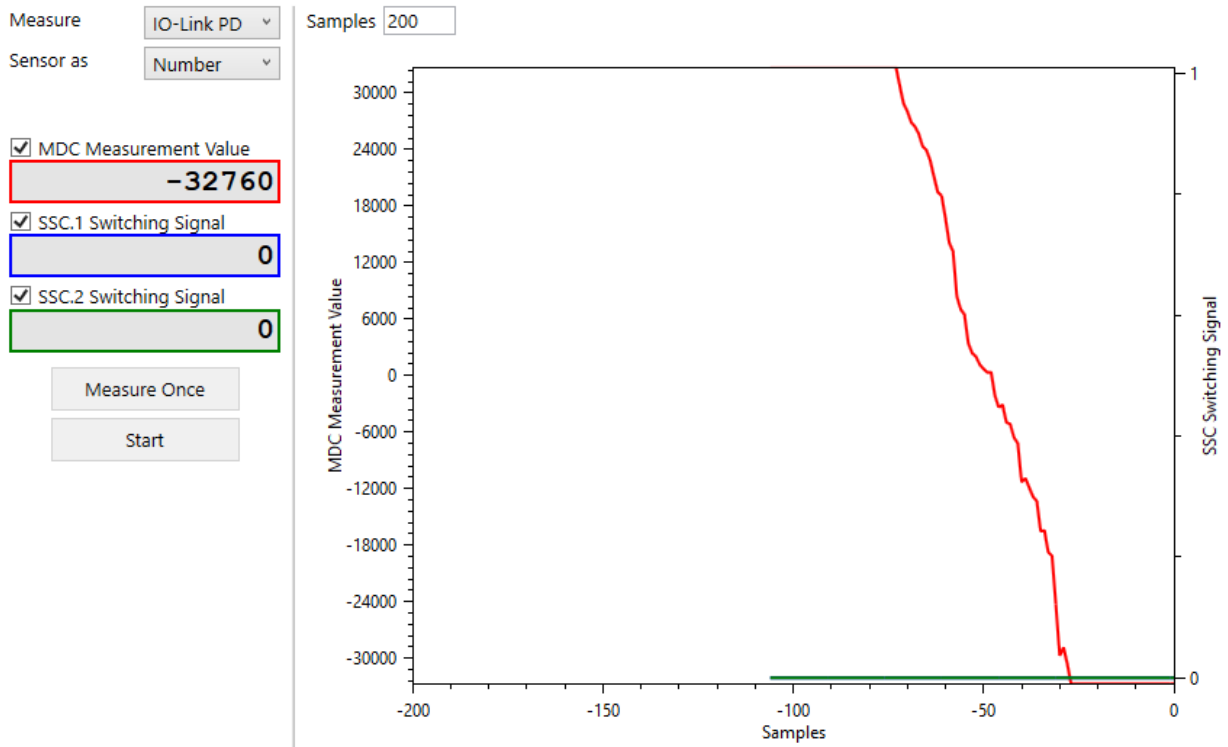

Figure 78. 0% to 100% Output (via Output Scaling)

### 3.3.4. Output Data Clipping Tab

The Output Data Clipping allows to apply a two-thresholds clipping function on the AOUT signal.

The clipping function is applied after the measured signal is corrected and not visible on the digital value for IO-Link.

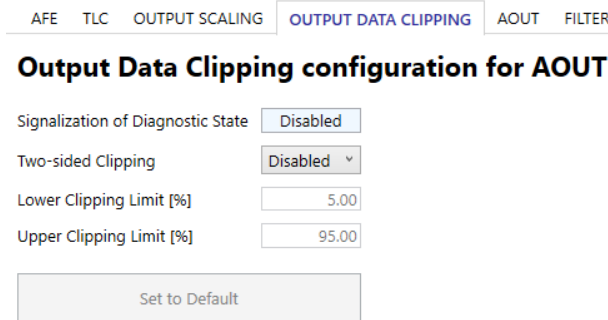

Figure 79. Output Data Clipping Default Settings

The signalization of the diagnostic state reflects the settings defined in the Diagnostic tab (section 3.5).

When the clipping is enabled, the “Lower Clipping Limit [%]” and “Upper Clipping Limit [%]” fields are editable (Figure 80).

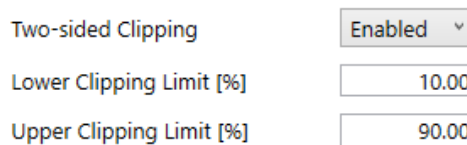

Figure 80. Clipping Limits

Store the settings in NVM via “Write Memory” to have the clipping functionality operational on measured input.



### 3.3.5. AOUT Tab

#### 3.3.5.1. Output Operation Modes

Figure 81 displays the analog output options. The available options require specific ZSSC3286 EVB settings shown in Table 5. Figure 82 shows the relevant jumpers and switches on the EVB.

**Note:** If Operation Mode is other than “Disabled”, in IO-Link COM Mode, AOUT pin output is always fixed to 0V. In Bootloader Mode, AOUT pin output is floating.

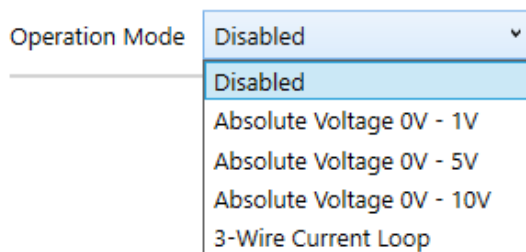

Figure 81. AOUT – Operation Mode

Table 5. ZSSC3286 EVB Settings for AOUT Operation Modes

Jumper/ Switch	Disabled	Absolute Voltage 0V - 1V	Absolute Voltage 0V - 5V	Absolute Voltage 0V - 10V	3-Wire Current Loop
J26	open	open	CB / P10	CB / P10	open
J25	n.a.	open	closed	closed	n.a.
J28	n.a.	open	closed	closed	n.a.
J30	n.a.	n.a.	x5	x10	n.a.
J29	open	open	optional	optional	open
J31	n.a.	n.a.	optional <b>Note:</b> If closed, ensure R6 (0Ω) on RH4Z2501-PMOD is set.	optional <b>Note:</b> If closed, ensure R6 (0Ω) on RH4Z2501-PMOD is set.	n.a.
J18	n.a.	n.a.	open/P10	open/P10	PMOD / P10 <b>Note:</b> If closed, ensure R6 (0Ω) on RH4Z2501-PMOD is set.
SW5	n.a.	Vout	Vout	Vout	CL
J41: VDDN- VSSD	n.a.	as configured in GUI	as configured in GUI	as configured in GUI	closed
J41: AOUT- FB	n.a.	as configured in GUI	open	open	open
J46	n.a.	closed	optional (showing 0V - 1V output)	optional (showing 0V - 1V output)	optional (showing 0V - 1V output)

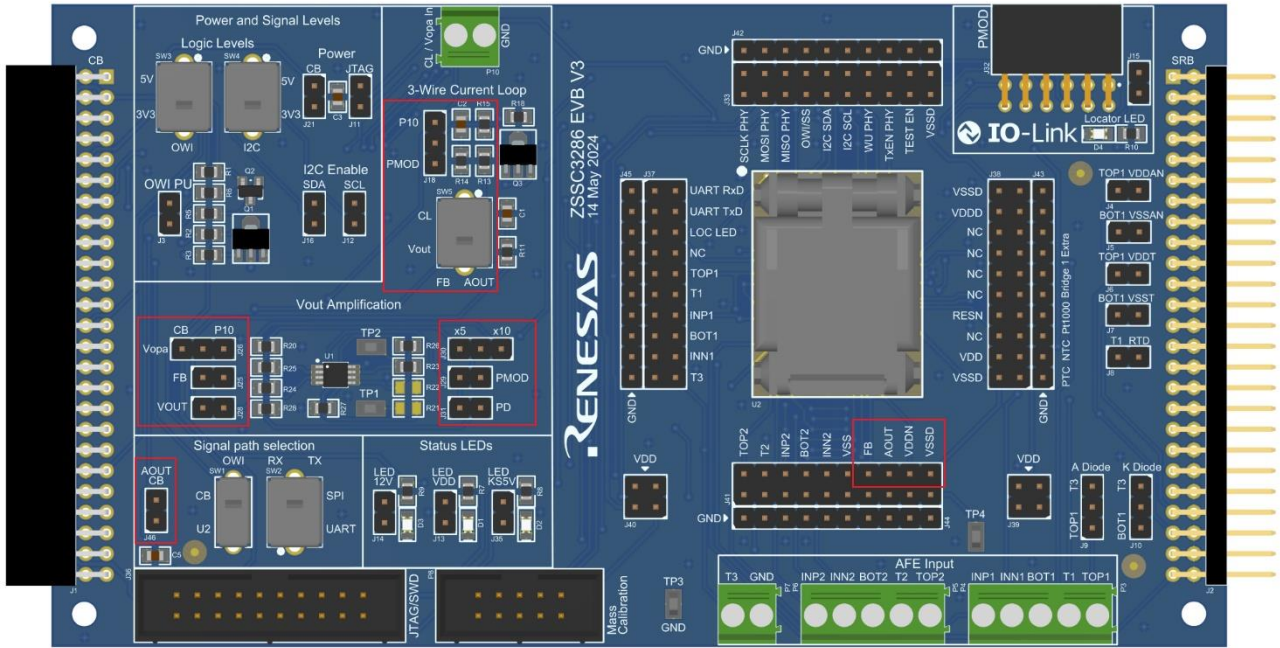

Figure 82. Jumpers and Switches for AOUT on ZSSC3286 EVB

3.3.5.1.1. Operation Mode: Disabled

In this mode, the DAC is disabled and the AOUT pin is floating.

3.3.5.1.2. Operation Mode: Absolute Voltage 0V - 1V

See Figure 83 for the Absolute Voltage 0V - 1V parameters configuration tab.

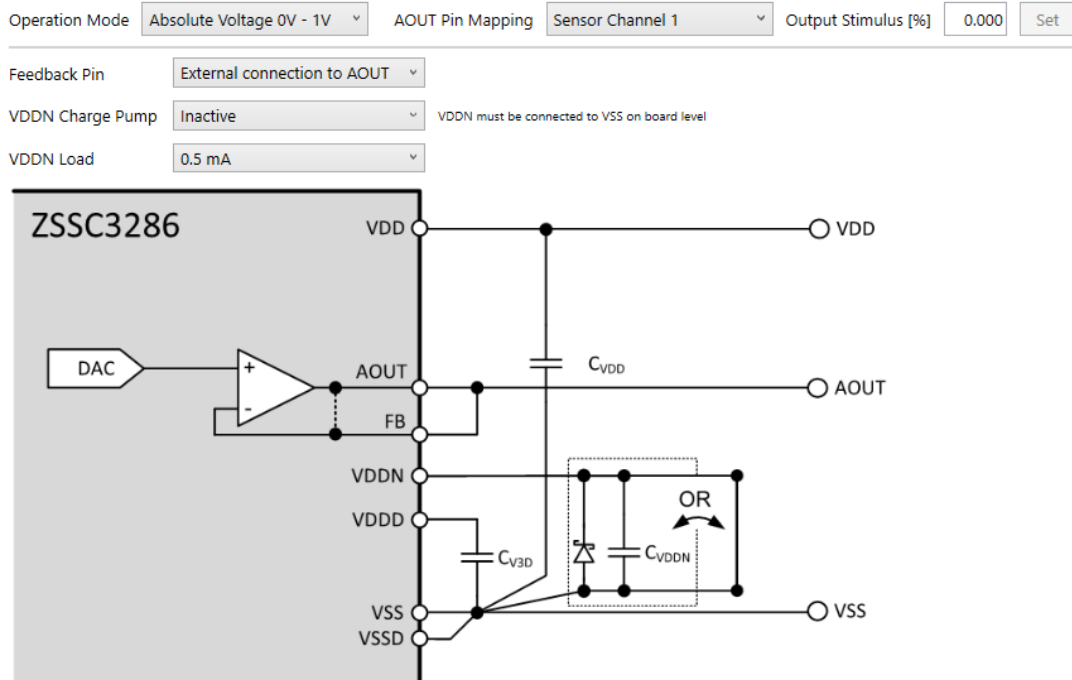

Figure 83. Absolute Voltage 0V - 1V Configuration

Parameters description:

- Feedback Pin: Defines if the FB pin needs to be connected to AOUT externally, or if it is connected to AOUT internally.
- VDDN Charge Pump: To support the driving of true 0V at AOUT, an internal charge pump can be activated which generates a negative voltage of approximately -0.6V at the VDDN pin. In this application scenario the connection between VDDN and VSSD must be opened and the external capacitor CVDDN must be connected between VDDN and VSSD. Otherwise, an external short is required between VDDN and VSSD.
- VDDN Load: the maximum output drive current of the VDDN charge pump can be configured. The higher the set output drive current, the higher the quiescent current of the ZSSC3286.

AOUT output voltage can be measured by the CB in Measure tab when J16 is set.

**Note:** Before starting the measurement with the “Start” button in Measure tab, it is necessary to save configuration in NVM (by clicking the “Write Memory” button in the GUI).

### 3.3.5.1.3. Operation Mode: Absolute Voltage 0V - 5V / Absolute Voltage 0V - 10V

For these modes, U1 (Operational Amplifier) is used to amplify the 0V - 1V analog voltage output of the ZSSC3286 externally to either 0V - 5V (x5) or to 0V - 10V (x10), selectable via J30. For voltage supply of U1, either 12V from CB or an external voltage via P10 can be used, selectable via J26. If using external voltage via P10 a sufficiently high voltage level must be ensured.

The FB (Feedback) pin of the ZSSC3286 is connected to the inverting input of U1 through J25 for higher gain factor accuracy.

By closing J31, the absolute voltage output can be mapped to pin 2 (I/Q) of the IO-Link M12 connector (X1) on the RH4Z2501-PMOD board.

**Note:** When setting J31, R6 (0Ω) must be set on RH4Z2501-PMOD board.

A 10kΩ absolute voltage output load to GND can be enabled by setting J31.

See Figure 84 exemplary for the Absolute Voltage 0V - 5V parameters configuration tab. Parameters are the same for Absolute Voltage 0V - 10V.

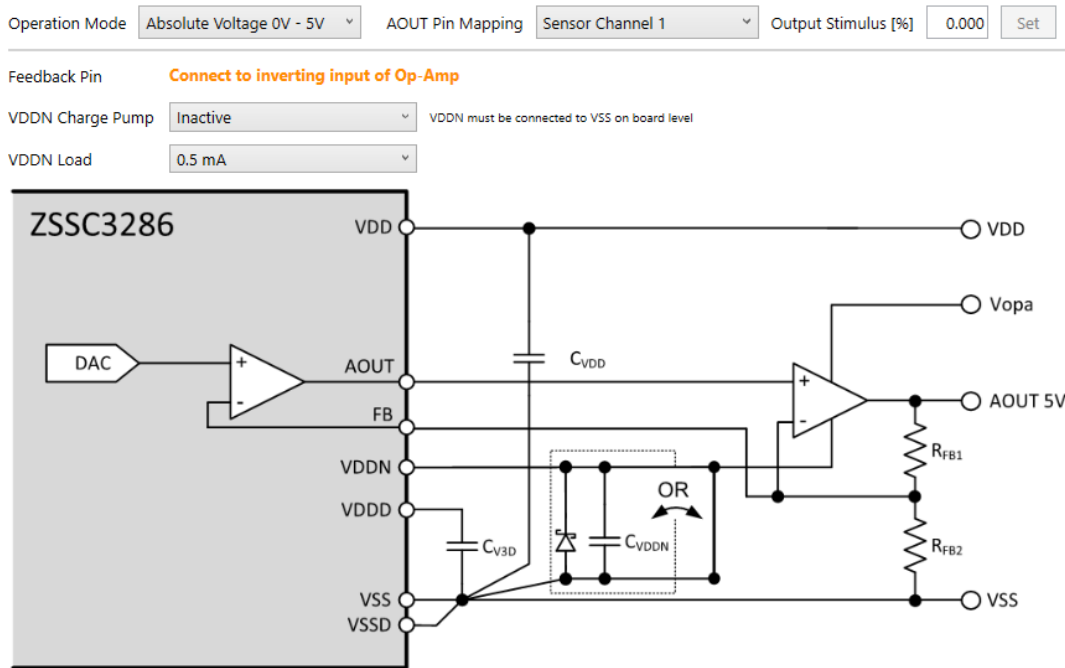

Figure 84. Absolute Voltage 0V - 5V Configuration

Parameters description:

- VDDN Charge Pump: To support the driving of true 0V at AOUT, an internal charge pump can be activated which generates a negative voltage of approximately -0.6V at the VDDN pin. In this application scenario the connection between VDDN and VSSD must be opened and the external capacitor CVDDN must be connected between VDDN and VSSD. Otherwise, an external short is required between VDDN and VSSD.
- VDDN Load: the maximum output drive current of the VDDN charge pump can be configured. The higher the set output drive current, the higher the quiescent current of the ZSSC3286.

AOUT output voltage (0V - 1V, before amplification) can be measured by the CB in Measure tab when J16 is set.

**Note:** Before starting the measurement with the “Start” button in Measure tab, it is necessary to save configuration in NVM by clicking the “Write Memory” button in the GUI.

### 3.3.5.1.4. Operation Mode: 3-Wire Current Loop

In 3-Wire Current Loop, AOUT is used to control an external NPN transistor as a current regulator for an externally applied voltage source (Figure 85). The ZSSC3286 EVB therefore serves as a current sink. FB pin is connected to a low side resistor in the current loop for current sensing (R18 on ZSSC3286 EVB, 43Ω).

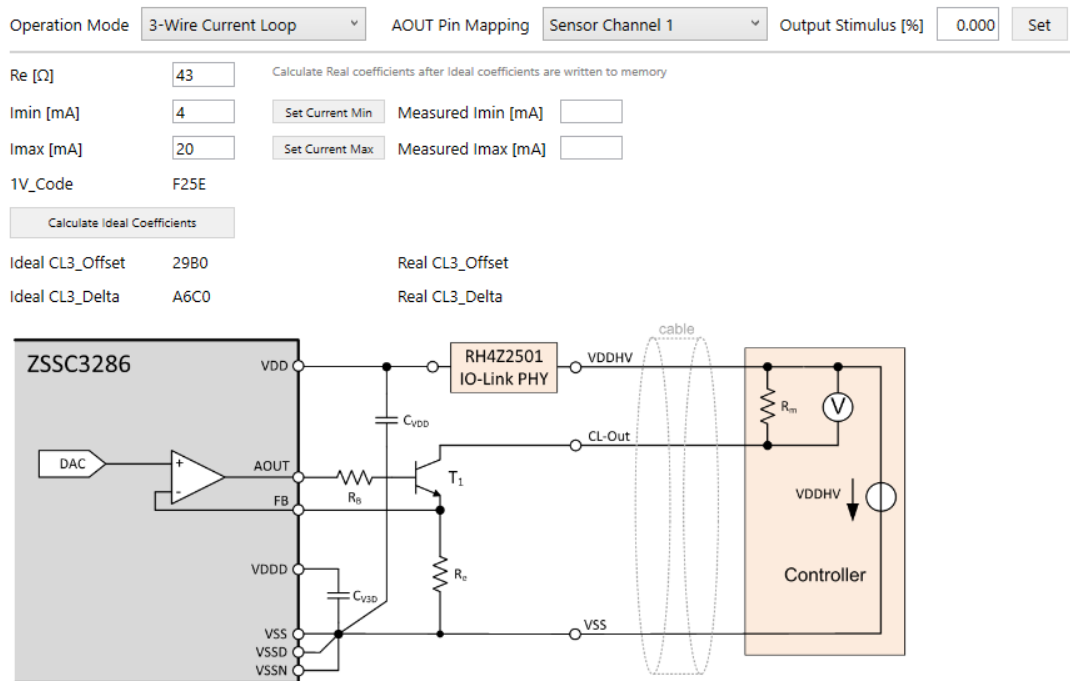

Figure 85. 3-Wire Current Loop Configuration

External voltage supply for the current loop can be sourced either via pin 2 (I/Q) of the IO-Link M12 connector (X1) on the RH4Z2501-PMOD board, or via P10, selectable via J18.

**Note:** R6 (0Ω) must be set on RH4Z2501-PMOD board if PMOD is used as voltage supply.

A current meter for measuring purposes can be connected between pin 2 on J18 and pin 1 (voltage supply via P10) or pin 3 (voltage supply via RH4Z2501-PMOD), thus replacing the jumper set on J18. A current limiting resistor (for example 390Ω) can optionally be used in series with the current meter.

**Note:** Before the current loop is ready to be calibrated, it is necessary to save configuration in NVM (by clicking the “Write Memory” button in the GUI main tab).

For sensor signal calibration refer to section 3.4. Follow these steps to calibrate the 3-wire current loop:

1. Set the “Re [Ω]”, “Imin [mA]”, and “Imax [mA]” values for the current loop input. “Re [Ω]” resistor on ZSSC3286 EVB is always 43Ω (R18).
2. Click the “Calculate Ideal Coefficients” button (see Figure 86).

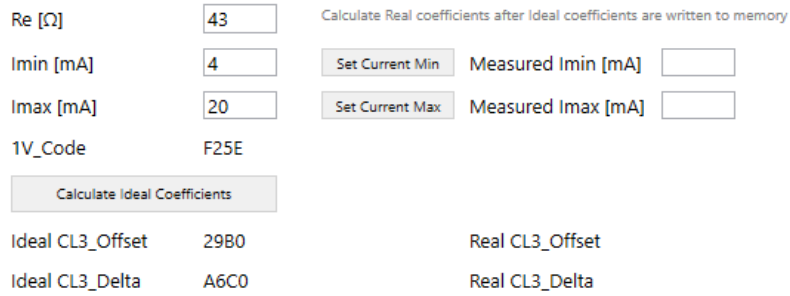

Figure 86. 3-Wire Current Loop Calibration

3. Click on “Write Memory”.

**Note:** “Set Current Min/Max” is not available in IO-Link COM mode.

4. Click on the “Set Current Min” button and measure the current in the loop with a current meter.
5. Input the measured value in the “Measured Imin [mA]” input field.
6. Click on the “Set Current Max” button and measure the current in the loop with a current meter.
7. Input the measured value in the “Measured Imax [mA]” input field.  
The GUI appears as displayed in Figure 87 (values are for reference only).

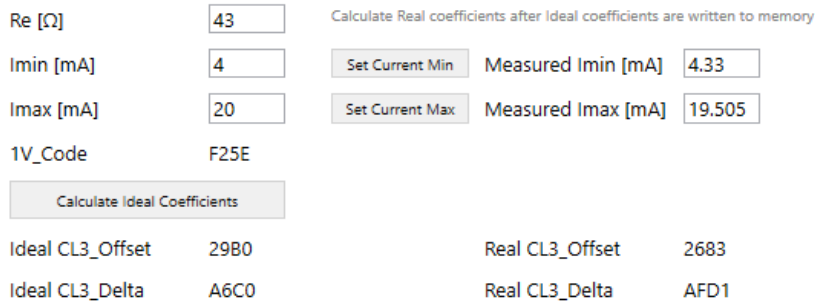

Figure 87. 3-Wire Current Loop calibration Measured Coefficients

8. Click on “Write Memory”.  
The current loop is calibrated and ready for measurements.

### 3.3.5.2. Channel Mapping

The AOUT pin can provide the analog output from different channels, select it from the AOUT Pin Mapping drop-down list (see Figure 88).

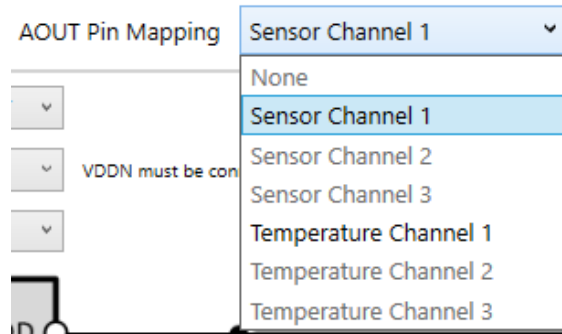

Figure 88. AOUT Pin Mapping

### 3.3.5.3. AOUT Output Stimulus

The AOUT can be directly driven with a fixed output level by entering the value to the Output Stimulus [%] field and clicking the 'Set' button (see Figure 89).

**Note:** Output Stimulus is not functional in IO-Link COM mode.

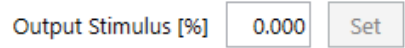

Figure 89. AOUT Output Stimulus

### 3.3.6. Filter Tab

The filter can be employed for each conditioned sensor signal in Cyclic Mode only. The location of the filter function in the processing path is highlighted in Figure 34. The purpose of the filter is noise reduction (low pass filter). The main capability of the IIR filter is to allow a compromise between noise reduction and response time.

**Note:** The step response gradually approaches the actual step value following an exponential like behavior.

The Filter tab is displayed in Figure 90.

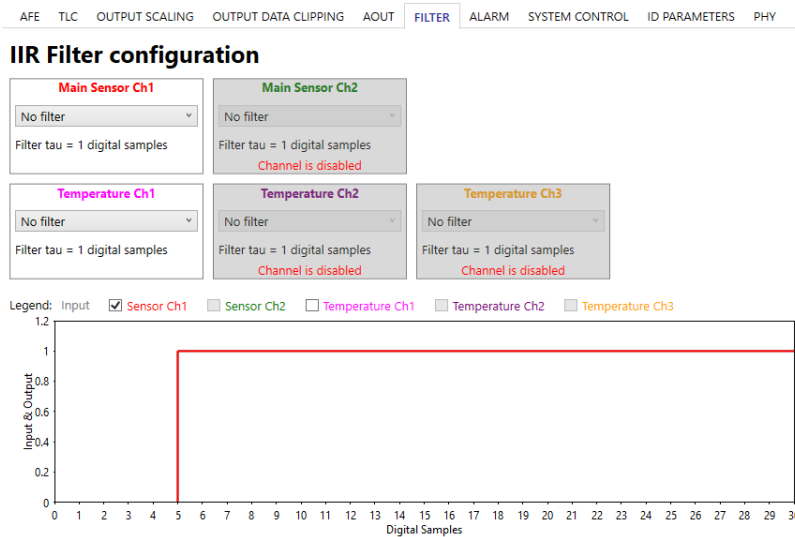

Figure 90. Filter Tab

The filter function applied to each of the channels displayed in Figure 90 is identical. The list of values displayed in Figure 91 allows the selection of the time constant ( $\tau$ ) of the filter, expressed in units of digital samples.

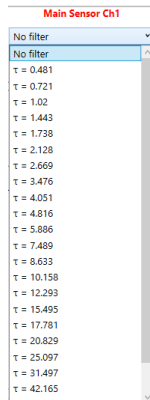
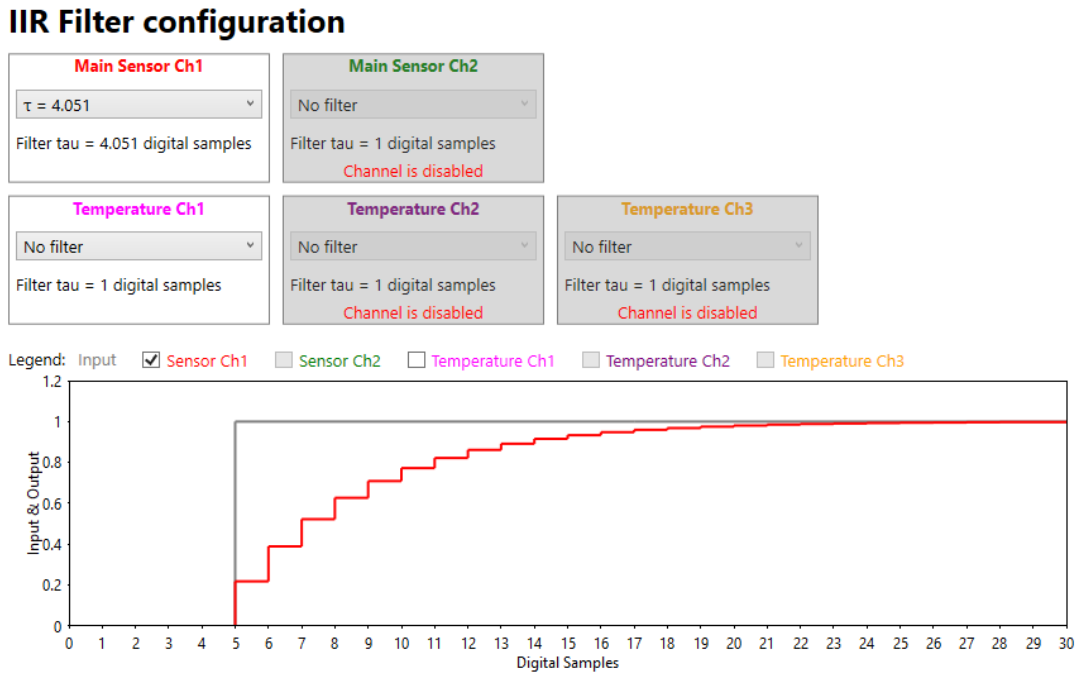

Figure 91. Filter Time Constant Setting

Filter behavior at the event of an input step is displayed in figure Figure 92 with a filter tau value of 4.051 (abscissa represents time in terms of digital samples).



**Figure 92. Filter Response (Digital Domain)**

To calculate the actual time needed for filter settling, measure the data rate of the output first (that is dependent on the selected resolution and the sequencer configuration). At 5 times the filter constant “tau”, 99.3% of steady step response signal are reached. Dividing the number of samples corresponding to 5 times “tau” by the data rate gives the result for the filter settling time.

**Note:** Before the filter function becomes operational, it is necessary to execute a “Write Memory” command to save the time constant in NVM.

**Note:** The filter configuration functionality is not available when operating the Step Response Mode (section 3.3.1.1.1).

### 3.3.7. Alarm Tab

When Alarm function is enabled, ZSSC3286 outputs a binary signal on UART TxD pin which propagates to the C/Q line of the IO-Link interface in SIO Mode. Any Sensor Switching Signal from IO-Link COM Mode can be mapped as a signal source for Alarm function. Sensor Switching Signal configuration is described in section 3.6.3.

Figure 93 shows the options for signal selection for Alarm function.

AFE	TLC	OUTPUT SCALING	OUTPUT DATA CLIPPING
Alarm in SIO mode		Enabled	
Sensor Switching Signal		SSC1	
Alarm Inversion		Disabled	

**Figure 93. Alarm Configuration Options**

- Alarm in SIO mode: Enables/Disables the Alarm feature in SIO mode.
- Sensor Switching Signal: Allows to choose one of the two available Sensor Switching Signals of SSP 4.1.1.
- Alarm Inversion: Allows to invert the Alarm signal. If disabled, the Sensor Switching Signal is output directly without inversion. If enabled, inversion is done before signal output.



### 3.3.8. System Control Tab

This tab gives access to Main Operation Mode control (Figure 94).



Figure 94. System Control tab

The “System Startup” drop-down list allows to define the active Operation Mode (Reference 3) at system startup. The selection is active after writing to NVM, see Figure 95. When connecting to a device, the GUI always enters Command Mode for memory read.

In the “CCP Password” field, the CCP Password of the current device can be set. CCP Password can be displayed in hex or decimal format by clicking on the button on the left side on the CCP Password entry field. The “Firmware Password” can be set in the respective field, consisting of maximum 16 characters. (Figure 96)

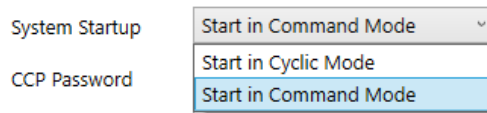

Figure 95. System Startup



Figure 96. CCP Password and Firmware Password

### 3.3.9. ID Parameters Tab

Identification (ID) Parameters are used for device identification via IO-Link. The parameters are stored in NVM and are readable via IO-Link ISDUs.

In this tab, the ID parameters can be set (Figure 97). The currently used parameter length for parameters of data type String is indicated (“Length:”) as well as the maximum possible Length of the parameter (“Max:”) right next to the corresponding field. See Reference 3 for details on ID Parameter description and implementation.



AFE	TLC	OUTPUT SCALING	OUTPUT DATA CLIPPING	AOUT	FILTER	ALARM	SYSTEM CONTROL	ID PARAMETERS
Vendor Name	<input type="text" value="To be filled by Renesas customer"/>							Length: 32, Max: 48
Vendor Text	<input type="text" value="To be filled by Renesas customer"/>							Length: 32, Max: 48
Product Name	<input type="text" value="To be filled by Renesas customer"/>							Length: 32, Max: 32
Product Text	<input type="text" value="To be filled by Renesas customer"/>							Length: 32, Max: 48
Product ID	<input type="text" value="To be filled"/>							Length: 12, Max: 32
Serial Number	<input type="text" value="To be filled"/>							Length: 12, Max: 16
Hardware Revision	<input type="text" value="To be filled"/>							Length: 12, Max: 16
Hardware ID Key	<input type="text" value="TO_BE_FILLED"/>							Length: 12, Max: 16
Vendor ID	<input type="text" value="396"/>	This is the Vendor ID of Renesas. Please change it when developing a product!						
Device ID	<input type="text" value="1"/>							
Bootloader Device ID	<input type="text" value="2"/>							
Application Specific Tag	<input type="text" value="***"/>							Length: 03, Max: 32
Function Tag	<input type="text" value="***"/>							Length: 03, Max: 32
Location Tag	<input type="text" value="***"/>							Length: 03, Max: 32

Figure 97. Identification Parameters

### 3.3.10. PHY Tab

This tab allows to control C/Q driver settings of the RH4Z2501 IO-Link PHY placed on the RH4Z2501-PMOD board (Figure 98).

**Note:** For further information on RH4Z2501 registers, see Reference 4.

AFE	TLC	OUTPUT SCALING	OUTPUT DATA CLIPPING	AOUT	FILTER	ALARM	SYSTEM CONTROL	ID PARAMETERS	PHY
Current Limit	<input type="text" value="200mA"/>								
Slew Rate Regulation	<input type="text" value="Enabled"/>								
Slew Rate	<input type="text" value="120V/μs"/>								

Figure 98. PHY Tab

The “Current Limit” drop-down list sets the C/Q driver current (Figure 99).

Current Limit	<input type="text" value="200mA"/>
Slew Rate Regulation	<input type="text" value="50mA"/>
Slew Rate	<input type="text" value="150mA"/>
	<input type="text" value="200mA"/>
	<input type="text" value="250mA"/>
	<input type="text" value="300mA"/>
	<input type="text" value="350mA"/>
	<input type="text" value="400mA"/>

Figure 99. PHY Current Limit

When “Slew Rate Regulation” drop-down list is set to “Enabled” (Figure 100), the drop-down list “Slew Rate” appears which allows to set the slew rate of the C/Q driver (Figure 101).

Slew Rate Regulation	<input type="text" value="Enabled"/>
Slew Rate	<input type="text" value="Disabled"/>
	<input type="text" value="Enabled"/>

Figure 100. PHY Slew Rate Regulation

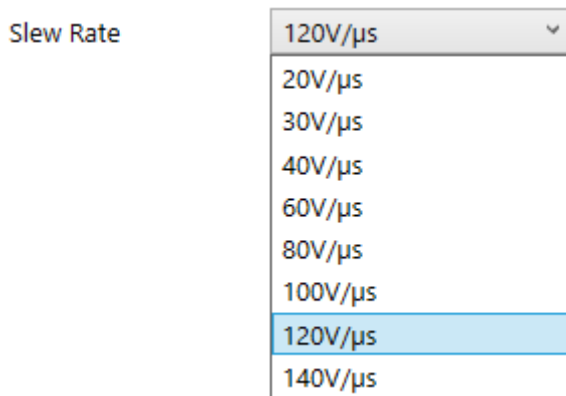

Figure 101. PHY Slew Rate

### 3.4 Calibration Tab

The Calibration tab (Figure 102) allows acquiring raw data and calculating the coefficients needed for signal linearization and temperature compensation.

Refer to the information provided in section 3.3.1.2 for mapping a Temperature transducer to a specific main sensor and its relevant signal processing.

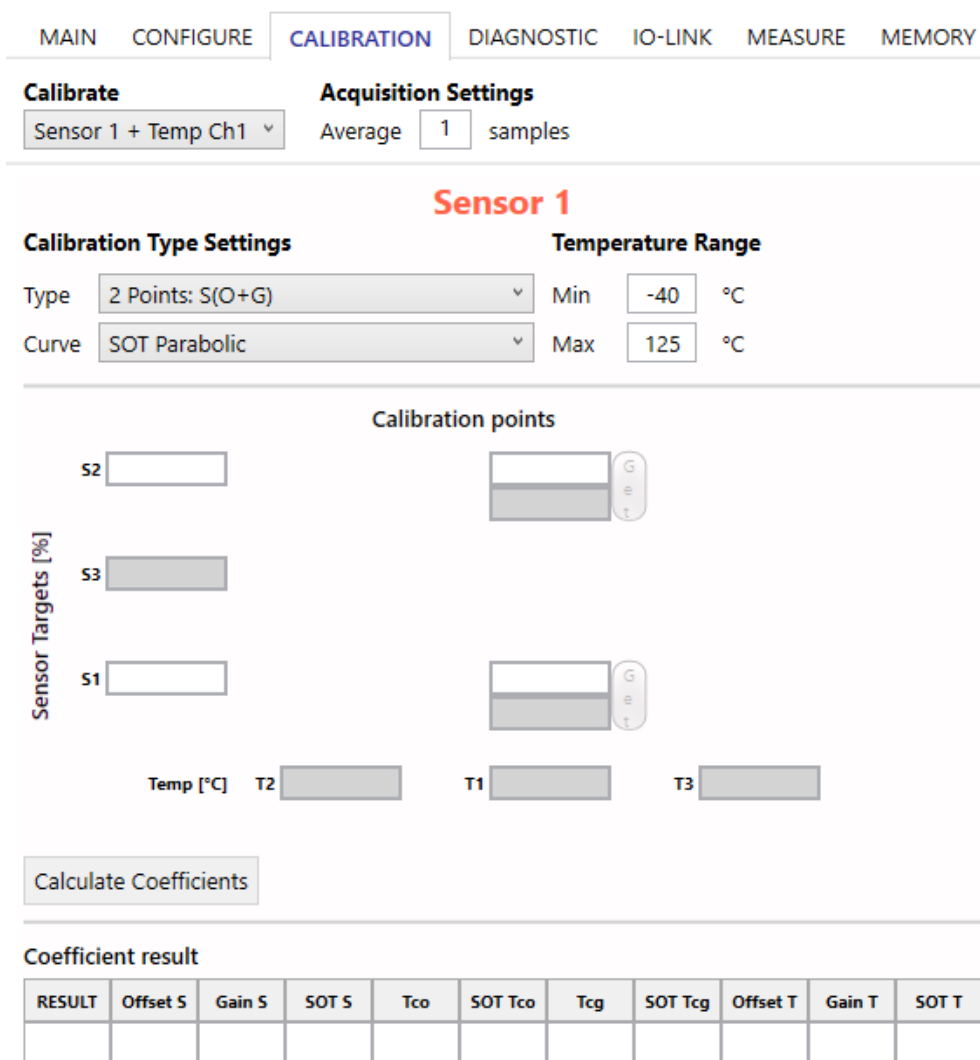

Figure 102. Calibration Tab

### 3.4.1. Sensor Selection and Acquisition Settings

Select Sensor 1/2 (and relevant Temperature Ch1/2) or Temperature Ch3 from the “Calibrate” drop-down menu. For each calibration point, the specified number of samples is averaged to remove ripple, selectable in the “Acquisition Settings” field (Figure 103).

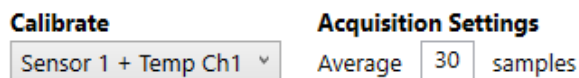

Figure 103. Sensor, Acquisition

### 3.4.2. Calibration Type Settings

The settings available in this area of the Calibration tab define the features of the calibration that are finalized with the data collection at the chosen calibration points.

#### 3.4.2.1. Type

The number of points of the selected input (main sensor and temperature channel) is defined by the selected option in the “Type” drop-down list (see Figure 104).

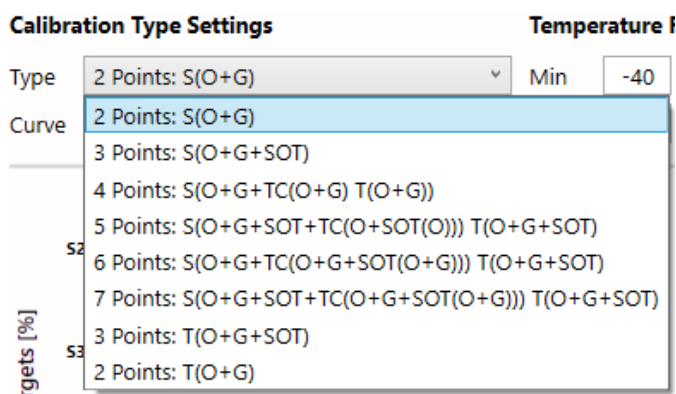

Figure 104. Calibration Type

Table 6 links the GUI mnemonic to the specific set of coefficients calculated and used for correcting the measurement before providing it on the chosen output. It also maps the mnemonic with a specific relevant set of measurements (Main Sensor and Temperature).

Table 6. Calculating Coefficients

Type	GUI	Calculated coefficients									Required set points		
		OFFSET_S	GAIN_S	TCO	TCG	SOT_S	SOT_TCO	SOT_TCG	OFFSET_T	GAIN_T	SOT_T	Main Sensor	Temp
2 Point	S(O+G)	✓	✓									2	0
3 Point	S(O+G + SOT)	✓	✓			✓						3	0
4 Point	S(O+G +TC(O+G) T(O+G))	✓	✓	✓	✓				✓	✓		2	2
5 Point	S(O+G +SOT + TC(O+SOT(O))) T(O+G+SOT))	✓	✓	✓		✓	✓		✓	✓	✓	3	3
6 Point	S(O+G+TC(O+G+SOT(O+G))) T(O+G+SOT))	✓	✓	✓	✓		✓	✓	✓	✓	✓	2	3

Type	GUI	Calculated coefficients									Required set points		
		OFFSET_S	GAIN_S	TCO	TCG	SOT_S	SOT_TCO	SOT_TCG	OFFSET_T	GAIN_T	SOT_T	Main Sensor	Temp
7 Point	$S(O+G+SOT+TC(O+G+SOT(O+G))) T(O+G+SOT)$	✓	✓	✓	✓	✓	✓	✓	✓	✓	✓	3	3
3 Point	$T(O+G+SOT)$								✓	✓	✓	0	3
2 Point	$T(O+G)$								✓	✓		0	2

### 3.4.2.2. Curve

A second-order equation can be selected to compensate for sensor nonlinearity by choosing one of the following options from the “Curve” drop-down menu (Reference 3 for mathematical details):

- SOT Parabolic (recommended for most transducers)
- SOT S-shaped

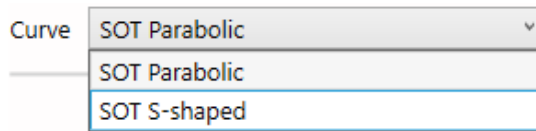

Figure 105. Curve

### 3.4.3. Temperature Range

The application temperature range must be specified by the user, entering values to the “Min” and “Max” fields (Figure 106).

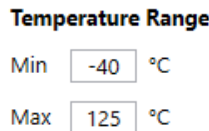

Figure 106. Temperature Range and Sample Settings

### 3.4.4. Calibration Points

Depending on the calibration type, the corresponding number of calibration points is displayed in the Calibration points matrix to illustrate the coverage of the measurement range.

When the calibration type is defined, the reference value  $S(x)$  for the Sensor Targets represents the final output data (as in sensor application) in percentage of the ADC full-scale range, after signal conditioning.

In the example in Figure 107, a raw bridge sensor value of -7039018 counts is mapped by calibration to 10% of full-scale range and a raw bridge sensor value of 6835669 counts is mapped by calibration to 90% of full-scale range.

Figure 107. Calibration Points Input

Definitions:

- Sensor Targets [%]: External sensor measurement reference point must be entered as a percentage of the full measurement range (sensor application range).
- Temp [°C]: Temperature measurement reference point must be entered in degrees Celsius.
- S(x): Raw external sensor measurement result in counts, values can be entered manually or fetched by clicking the “Get” button.
- T(x): raw temperature measurement result in counts, values can be entered manually or fetched by clicking the “Get” button.

### 3.4.5. Calculating and Setting Coefficient Results

When the complete set of calibration data is collected, the correction coefficients can be calculated by clicking the “Calculate Coefficients” button (see Figure 108).

Figure 108. Calculate Coefficients, Set in GUI

The calculated coefficients are displayed in the “Coefficient result” table (see Figure 109 for an example with two calibration points).

Coefficient result

RESULT	Offset S	Gain S	SOT S	Tco	SOT Tco	Tcg	SOT Tcg	Offset T	Gain T	SOT T
SUCCESS	25418	2028694								

Figure 109. Coefficient Result

The result can be either:

- Success: Calibration coefficients can be saved in the NVM by clicking the “Set in GUI” button (Figure 109) and executing a Write Memory action.
- Failed: The calculated coefficients which are out of range are displayed in red. In this case, a new calibration shall be started.

### 3.5 Diagnostic Tab

The Diagnostic tab (Figure 110) enables controlling the diagnostic tests via the GUI. The Diagnostic functionality is limited for Step Response Mode (3.3.1.1.1).

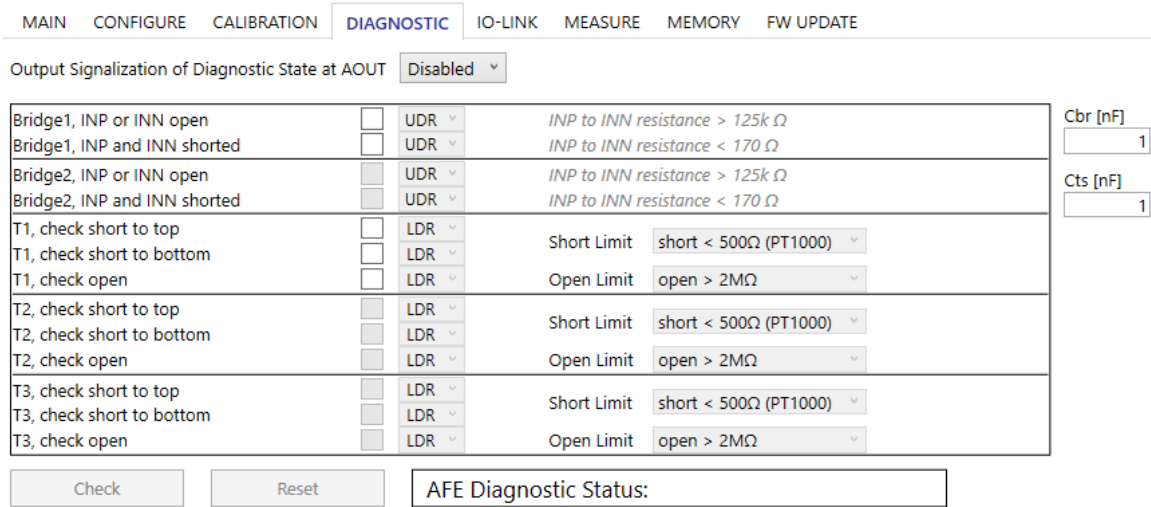

Figure 110. Diagnostic Tab

Diagnostic state can be enabled or disabled on AOUT pin (see section 3.3.4 and Reference 3 for details) with the “Output Signalization for Diagnostic State at AOUT” drop-down list. Output Data Clipping must be enabled for this feature to take effect.

In the diagnostic test table, marking the relevant check box enables the corresponding diagnostic test. If a test requires additional user input, it must be entered in the input field available on the right side. See Reference 3 for a comprehensive description of the diagnostic features.

#### 3.5.1. User Selectable Input Fields

The Sensor/AFE tab has the following fields:

- Cbr [nF] and Cts [nF] fields: Values from 0nF to 2nF are allowed, the corresponding capacitors are displayed in Figure 111.

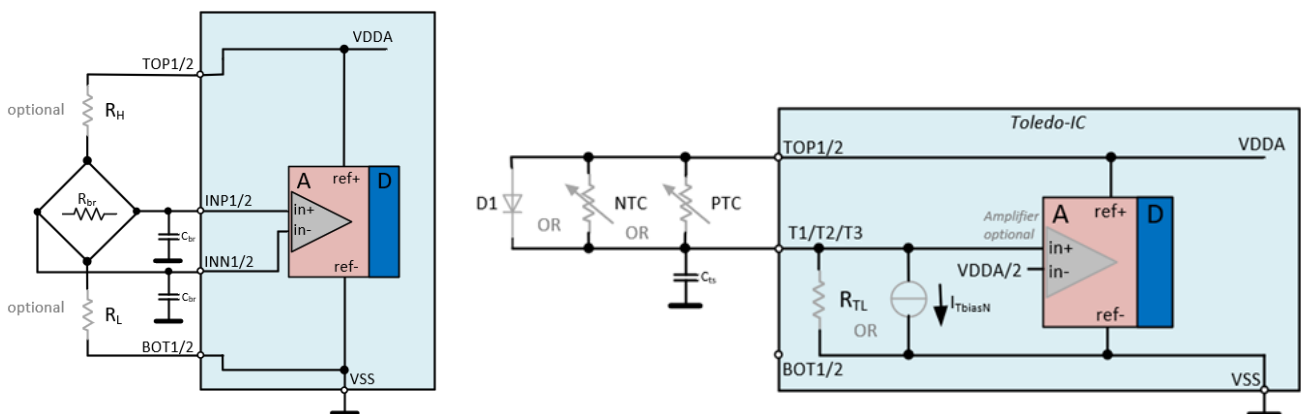

Figure 111. Cbr and Cts Capacitors

- UDR/LDR drop-down lists: Defines if an upper or lower diagnostic range of signalization level is used on the AOUT and/or FOUT pins for the selected check (Figure 112).

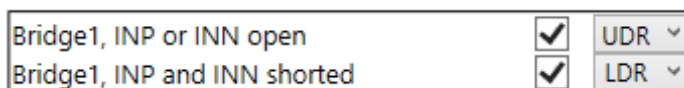

Figure 112. UDR/LDR Selection

- Short Limit/Open Limit options: Limits are selectable from the drop-down lists. Only “short < 500Ω (PT1000)” is available for the short limit (T1, T2, T3). The following options are available for open limits (T1, T2, T3):
  - open > 2MΩ
  - open > 500kΩ
  - open > 100kΩ

### 3.5.2. Diagnostics Operation

Diagnostic check and reset can be started with the relevant buttons.

**Note:** To have the specific set of diagnostic features operational, execute a “Write Memory” action. The “Check” and “Reset” buttons are disabled until the NVM is updated (Figure 113).



Figure 113. Diagnostic Check and Reset

### 3.5.3. AFE Diagnostic Status

The Diagnostic tab provides the current Diagnostic Status (Figure 114).

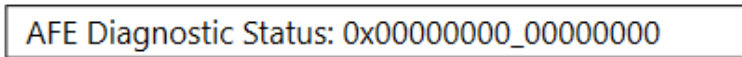

Figure 114. AFE Diagnostic Status

When diagnostic checks do not return a fault, Status is set to “0” (two 32 bits words). A check detecting a fault determines a change in the AFE Diagnostic Status value.

A comprehensive description of the Diagnostic Status is provided in Reference 3.

### 3.5.4. AFE Diagnostic Operation Example

In this diagnostics operation example, check for shorts between INP1 and INN1 are used, AFE1 is enabled, the “Bridge1, INP and INN shorted” check box is enabled (Figure 115), and a “Write Memory” is executed.



Figure 115. Activation of Diagnostic Check

Performing the diagnostic check by clicking on the “Check” button returns a successful the result (Figure 116).

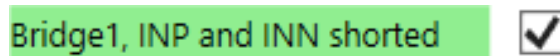

Figure 116. Diagnostic Check Pass

After clicking on “Reset” and placing a short between the INN1 and INP1 pins on the ZSSC3286 EVB, another performed check fails (Figure 117).

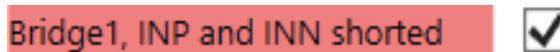

Figure 117. Diagnostic Check Fail

In the IC Status, the failure is reported as “Sensor Connection Fail”, displayed in Figure 118.

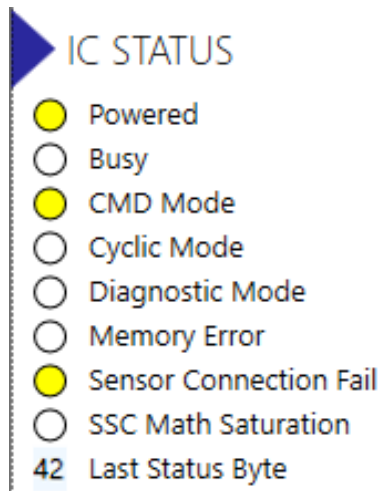

Figure 118. IC Status Sensor Connection Fail

### 3.6 IO-Link Tab

This tab offers setting options for the Smart Sensor Profile (SSP). It allows to execute device functions and log events specific to IO-Link and create the IO-Link Device Description (IODD). The ZSSC3286 implements SSP 4.1.1 which is structured as shown in Figure 119. All SSP specific settings and options in the GUI relate to SSP 4.1.1.

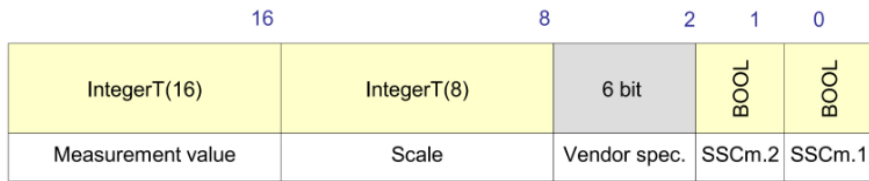

Figure 119. Structure of SSP 4.1.1

#### 3.6.1. SSP Channel Mapping Tab

In this tab, the data source mapped to Measurement Data Channel 1 of SSP4.1.1 can be chosen via the drop-down list in Figure 120. Availability of data sources depends on AFE (section 3.3.1) and TLC (section 3.3.2) settings.

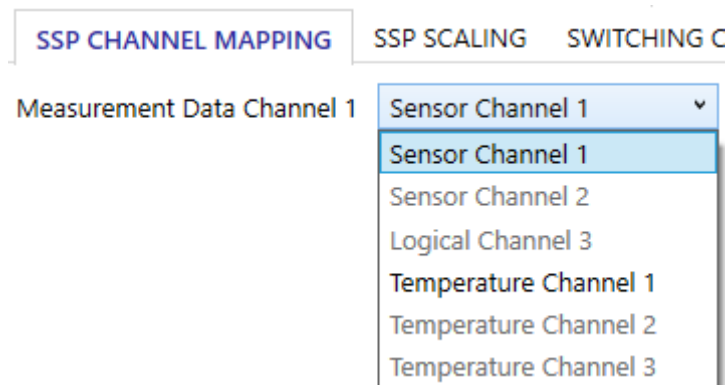

Figure 120. SSP Channel Mapping



### 3.6.2. SSP Scaling Tab

This tab is used to rescale the data mapped to the SSP (section 3.6.1) and apply physical units. Using the inputs in this tab, the GUI calculates the Coefficients for SSP Scaling. For reference, the structure of SSP 4.1.1 is displayed in the graphic at the top of the tab (Figure 121).

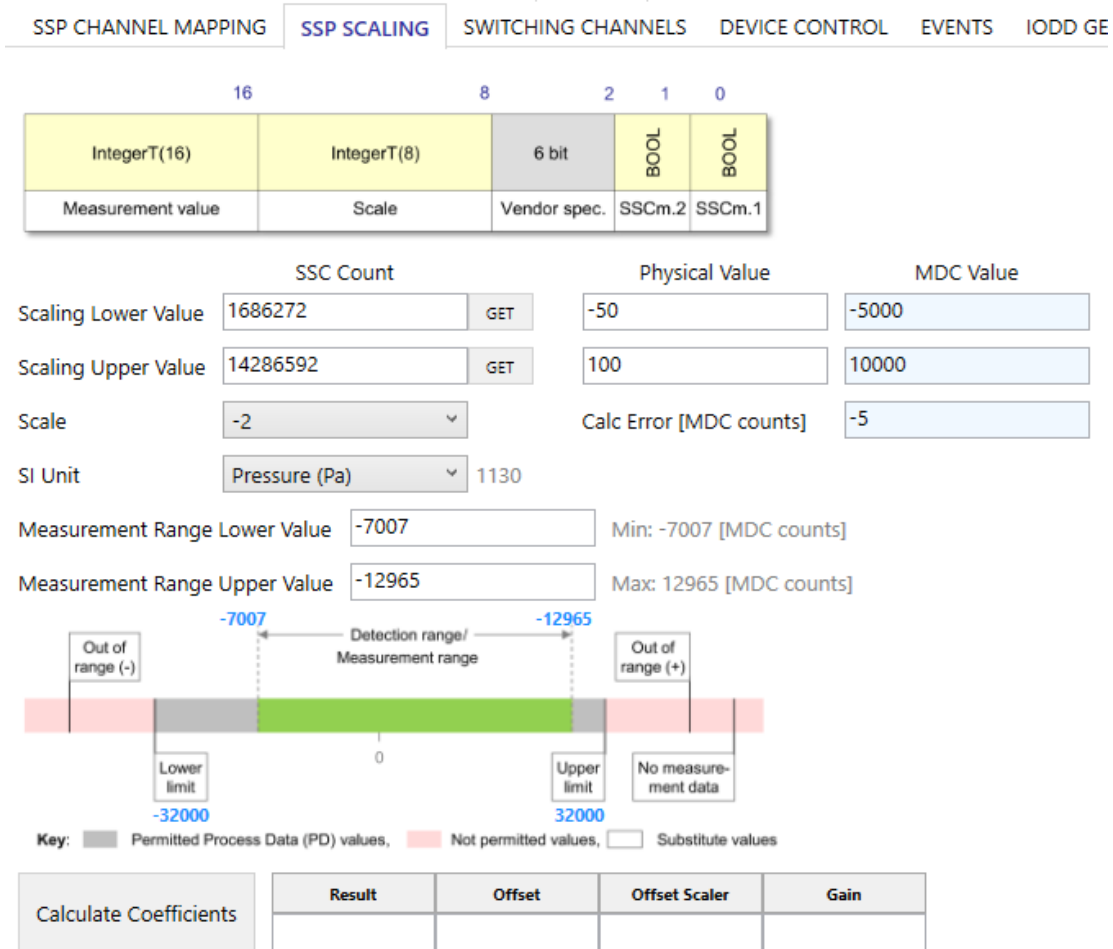

Figure 121. SSP Scaling Tab

#### 3.6.2.1. Assignment of Physical Values, Scale and Unit

SSP Scaling is a linear scaling process, defined by two points, the “Scaling Lower Value” and “Scaling Upper Value”. Each point assigns an “SSC Count” (24bit Conditioned Data or 32bit Conditioned Data for TLC, Figure 34) to a “Physical Value” (16bit Process Data within SSP 4.1.1 MDC, ranging from -32000 to +32000 counts). For more information about IO-Link Rescaling, see Reference 3. All explanations in this section refer to Figure 122.

The “SSC Count” fields allow to enter values manually or to fetch the currently measured value by clicking the “Get” button next to the corresponding field. The desired corresponding “Physical Value” must be entered in the respective field next to SSC Count field.

Applying the “Scale” to the “Physical Value” results in the “MDC Value”. The “MDC Value” represents the counts within the 16bit Process Data of SSP 4.1.1. The GUI automatically chooses the “Scale” value which leads to the highest accuracy in the Process Data (i.e. the lowest value, since it leads to the highest range in the Process Data). Via the drop-down list, all possible values for “Scale” are available and can be chosen.

The GUI calculates and displays the maximum error over the entire valid Process Data range as MDC counts in the “Calc Error [MDC counts]” as the result of the scaling process.

The “SI Unit” drop-down list includes all possible units defined by IO-Link standard; the corresponding unit code (4-digit number) is displayed next to the list. The chosen unit is assigned to the SSP.

“Scale” and “SI-Unit” are updated in the GUI after a memory read of the ZSSC3286.

	SSC Count	Physical Value	MDC Value
Scaling Lower Value	1686272 GET	-50	-5000
Scaling Upper Value	14286592 GET	100	10000
Scale	-2	Calc Error [MDC counts]	-5
SI Unit	Pressure (Pa) 1130		

Figure 122. Assignment of Physical Values, Scale and Unit

### 3.6.2.2. Range Definition

The IO-Link standard defines a valid Process Data range and an out-of-range event where replacement values are the substitute output for the Process Data. The ZSSC3286 does not differentiate between “Detection range/Measurement range” as valid Process Data range (see Figure 123), it can reach beyond the specified lower or upper scaling points defined in section 3.6.2.1. The Conditioned Data range, defined by the calibration process (section 3.4), is used as input for Rescaling and normally reaches further than the lower or upper scaling points and allows MDC values to be outside the lower or upper Scaling Value.

Via the fields “Measurement Range Lower/Upper Value” the “Detection range / Measurement range” can be defined within the limits of Conditioned Data range. Based on calibration range, the GUI automatically calculates the limits for “Measurement Range Lower/Upper Value” and displays them next to the corresponding fields.

“Measurement Range Lower/Upper Value” fields are updated in the GUI after memory read of the ZSSC3286.

For easier understanding, the set range values are added to the graphic at the bottom of the GUI as blue numbers.

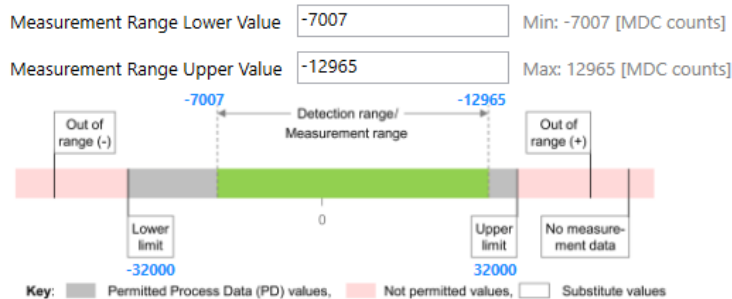

Figure 123. Process Data Range Definition

### 3.6.2.3. Scaling Coefficients

By clicking on the “Calculate Coefficients” button, the SSP Scaling Coefficients are calculated from the settings in this tab and are set in Memory tab. “Offset” and “Gain” define the linear scaling between SSC Counts and MDC Counts. The “Offset Scaler” is an additional scale factor for “Offset” and stays at 1 for SSP 4.1.1.

A “Write Memory” command needs to be executed for the changes to become effective.

Calculate Coefficients	Result	Offset	Offset Scaler	Gain
	SUCCESS	-7007	1	1248

Figure 124. SSP Scaling Coefficients

### 3.6.3. Switching Channels Tab

This tab enables configuration of both Sensor Switching Channels of SSP 4.1.1 in an independent side-by-side tab layout (Figure 125). This document uses SSC.1 Switching Signal 1 as an example for describing the feature.

**Note:** Configuration changes done via this tab do not require “Write Memory” action to become effective (except “Detection Mode”).

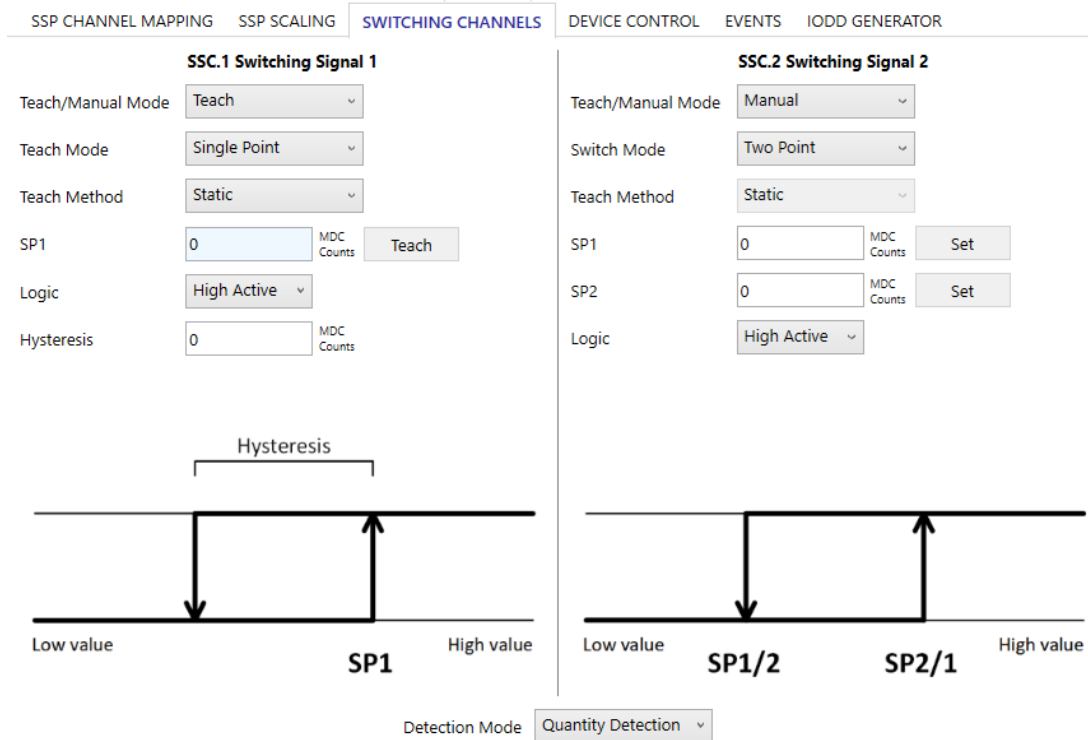

Figure 125. Switching Channels Tab

Use the “Teach/Manual Mode” drop-down list to define either of the following switching values (Figure 126).

- Teach: selects the IO-Link Teach functionality which uses measured values in real-time to define switching values. It enables the drop-down list “Teach Mode”.
- Manual: allows the user to manually enter switching values in input fields and clicking the “Set” button (Figure 129). It enables the drop-down list “Switch Mode”.

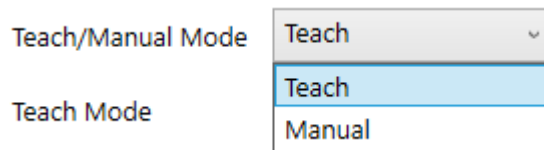

Figure 126. Teach/Manual Mode

Select either of the following options from the “Switch Mode” or “Teach Mode” drop-down list to define how Setpoints (SP) are interpreted in the context of switching behavior (Figure 127):

- Deactivated: No switching is performed, and Sensor Switching Channel output is kept low. All options below “Teach Method” are hidden.
- Single Point: Switching is performed based on a single SP in combination with a hysteresis value. With this option only the “SP1” field is available for entering Setpoints. In “Teach” mode the “SP1” field is read-only.
- Two Point: Switching is performed based on two SPs which inherently define hysteresis. With this option both “SP1” and “SP2” fields are available for entering Setpoints. In “Teach” mode “SP1” and “SP2” fields are read-only.

- Window: Switching is performed based on two SPs. They form a logic window via two switching points defined by the SPs in combination with a hysteresis value.  
With this option both “SP1” and “SP2” fields are available for entering Setpoints. In “Teach” mode “SP1” and “SP2” fields are read-only.

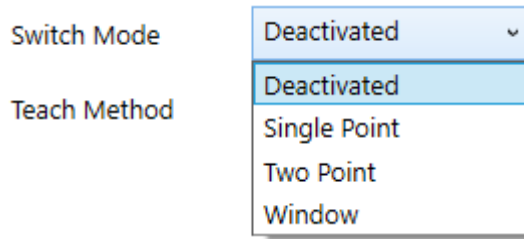

Figure 127. Switch Mode / Teach Mode

Select either of the following as data acquisition mode for defining Teach values from the “Teach Method” drop-down list (Figure 128):

- “Static”: The currently available Process Data value is taken as Teach value by clicking the “Teach” button (Figure 130).
- “Dynamic”: Process Data acquisition is started and must be stopped manually with the “Teach Start” and “Teach Stop” buttons. The Process Data values acquired between Teach start and stop action are arithmetically averaged and the result becomes the Teach value.  
A started Teach process can be aborted by clicking the “Cancel” button (Figure 131).

**Note:** “Teach Method” is only available if “Teach” is selected from the “Teach/Manual Mode” drop-down list.

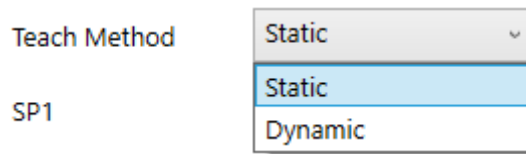

Figure 128. Teach Method

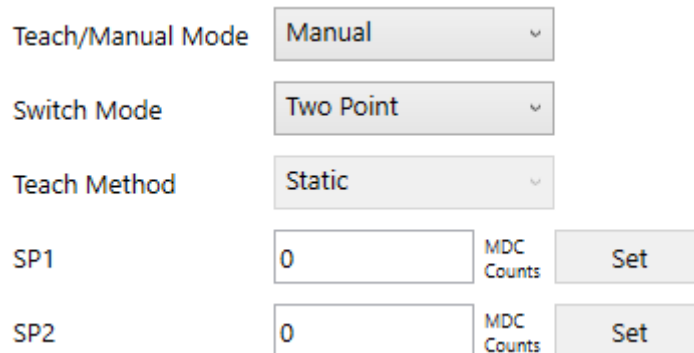

Figure 129. Setpoint fields in Manual Mode, Two Point Mode

Teach/Manual Mode

Teach Mode

Teach Method

SP1  MDC Counts

SP2  MDC Counts

Figure 130. Setpoint fields in Teach Mode (Static), Two Point Mode

Teach/Manual Mode

Teach Mode

Teach Method

SP1  MDC Counts

SP2  MDC Counts

Figure 131. Setpoint fields in Teach Mode (Dynamic), Two Point Mode

Via the “Logic” drop-down list (Figure 132), the switching output function can be inverted (flipped on a horizontal axis).

Logic

- High Active
- High Active
- Low Active

Figure 132. Logic

In “Single Point” or “Window” teach mode, switching hysteresis can be defined by the “Hysteresis” field (Figure 133). Alignment of hysteresis is shown in the graphic section (Figure 134).

Hysteresis

Figure 133. Hysteresis

A graphic displays the switching logic and behavior depending on selection for the options of the tab. Figure 134 shows an example graphic for “Window” mode and “High Active” switching signal settings.

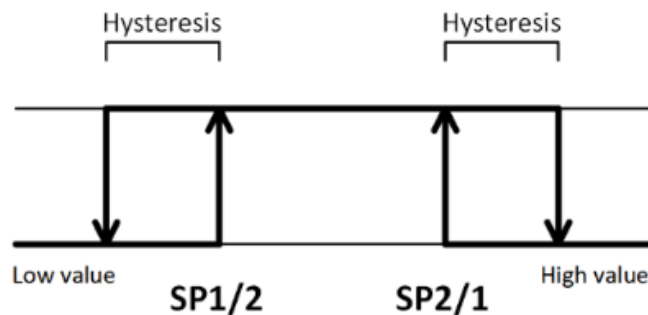

Figure 134. Example for Switching Behavior Graphic in Window Mode

“Detection Mode” option (Figure 135) effectively inverts the output logic (flipping the switching behavior graphic on a vertical axis) and is available in “Single Point” and “Two Point” mode. This option affects all Sensor Switching Channels within the SSP simultaneously.

According to IO-Link standard and assuming “High Active” logic, the following terms are used:

- Object Detection: A switching signal stays active for low measurement values and transitions to inactive for, for example, object distance/range measurement.
- Quantity Detection: a switching signal transitions from inactive to active with increasing values (at a certain quantity threshold).

After changing Detection Mode, “Write Memory” must be performed to become effective.

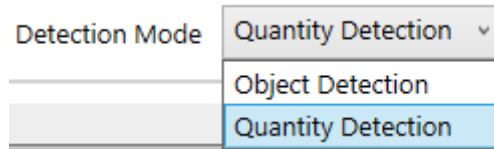

Figure 135. Detection Mode

### 3.6.4. Device Control Tab

The Device Control Tab offers IO-Link Device Control options and Locator feature control.

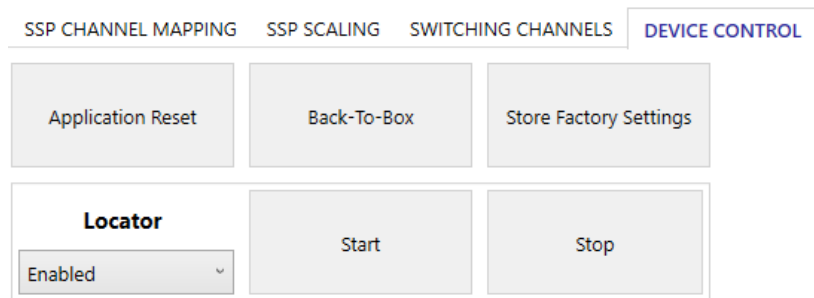

Figure 136. Device Control Tab

The following functions are available on the Device Control tab:

- Application Reset: Performs IO-Link device application reset. Only application-specific parameters are reset (for example, switching points). ID parameters stay unchanged. Master-Device connection stays uninterrupted.
- Back-To-Box: Performs IO-Link Back-to-box command. Application-specific parameters and ID parameters are reset. After executing this command, the Device stays disconnected and a new “Connect” needs to be performed.
- Store Factory Settings: The IO-Link application-specific parameters and ID-parameters are backed-up for restoring via “Application Reset” or “Back-To-Box” commands.  
 Note: At delivery state, ZSSC3286 stores the default parameters from Renesas as a back-up. As soon as custom IO-Link parameters are applied, they should be stored via “Store Factory Settings” command.
- Locator function: It can be used to identify the EVB to which the GUI is connected by letting the Locator LED blink periodically on the EVB (D4).
  - Drop-down list: The Locator function can be enabled/disabled.
  - Start: starts the blinking pattern
  - Stop: stops the blinking pattern

### 3.6.5. Events Tab

The GUI supports receiving and displaying IO-Link events. The events are displayed chronically in a list (Figure 137). The “Time Stamp” refers to the time of fetching the event from the IO-Link Master, not the actual occurrence of the event at the Device or Master.

Events are only fetched on demand by clicking on the button “Start/Stop Checking”. During event checking, the check for events and the received events are logged in the communication log. Checking for Events is done at an interval of at least 300ms. The Event list in the GUI can be cleared by clicking the “Clear List” button.

Timestamp	Code	Mode	Type	Source	Instance	Name
18:30:56	0x1800	Appears	Error	Master	System	COMLOST
18:30:56	0x1800	Disappears	Error	Master	System	COMLOST



Figure 137. Events Tab

### 3.6.6. IODD Generator Tab

This tab gives access to the IO-Link Device Description (IODD) Generator (Figure 138) that generates an IODD based on the current configuration of the ZSSC3286 and integrates direct customer input.

SSP CHANNEL MAPPING
SSP SCALING
SWITCHING CHANNELS
DEVICE CONTROL
EVENTS
IODD GENERATOR

Select IODD Directory

C:\Users\exampleuser\AppData\Roaming\Renesas\ZSSC3286 Demonstrator

Generate IODD

Select IODD Checker

Mode

Check and Zip

Open Output Directory

Vendor Name in Filename	Renesas
Device Name in Filename	DeviceName
Device Name	A sensor device
Device Family	Device Family
Document Copyright	To be filled by customer
Document Version	V1.1
Vendor URL	
Vendor Logo File	Select
Device Icon File	Select
Device Symbol File	Select
Connector Symbol File	Select
MDC1 Max Hysteresis	200
MDC1 Offset	0
MDC1 Gradient	1

Figure 138. IODD Generator Tab

### 3.6.6.1. Generator Control

The top section of the tab provides file control (Figure 139). The output directory for the IODD can be defined by clicking the “Select IODD Directory” button in the file control section (Figure 139). The chosen output path is displayed in the editable field next to the button and can be opened with the “Open Output Directory” button.

The path to the IODD checker can be defined by clicking the “Select IODD Checker” button. The chosen output path is displayed in the editable field next to the button. The GUI is compatible with IODD V1.1.3 Checker V1.1.12. The IODD Checker can be downloaded from the official IO-Link website: <https://io-link.com/en/>

Clicking the “Generate IODD” button starts the IODD Generator to create the IODD files.

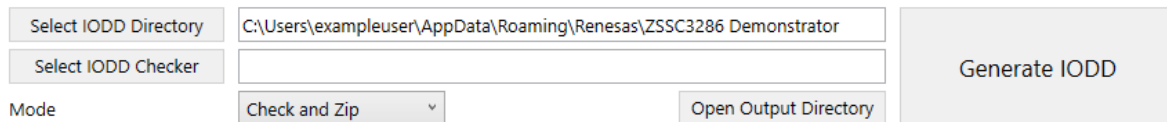

Figure 139. IODD Generator Control

The “Mode” drop-down list offers three output options for checking and compressing the IODD (Figure 140). Only when checking the IODD, a valid CRC stamp at the end of the IODD file is created.

- Check and Zip: The IODD is checked by the selected IODD Checker, and the output files are compressed into a ZIP file. A ZIP file is needed for most IO-Link Master control tools to import the IODD.
- Don't check and Zip: The IODD is neither checked, nor are the output files compressed.
- Don't Zip: The IODD is checked, but the output files are not compressed.

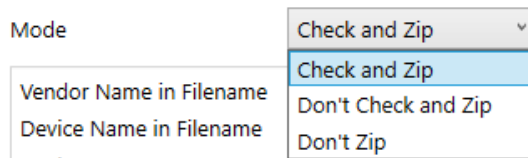

Figure 140. IODD Generator Mode

### 3.6.6.2. Manufacturer and Application Specific Options

The lower section of the tab consists of input fields for manufacturer and application specific attributes or elements. The upper input fields provide vendor and device information to the customer.

The four image files, selectable via “Select” button or via the input field, are displayed in IO-Link Master control tools and are all optional. Image file format must comply with IO-Link standard as shown in Table 7:

Table 7. IODD Image File Formats

Image Name	Image Size (pixel)	File Format	File Name as Output Data
Vendor Logo	160 x 90 (landscape oriented)	PNG	VendorName-logo.png
Device Icon	48 x 48 (square)	PNG	VendorName-DeviceName-icon.png
Device Symbol	min. 160 x 160 max. 320 x 320 (square)	PNG	VendorName-DeviceName-pic.png
Connector Symbol	min. 160 x 160 max. 320 x 320 (square)	PNG	VendorName-DeviceName-con-pic.png

The value in “MDC1 Max Hysteresis” field limits the hysteresis of all Sensor Switching Channels (section 3.6.3) for the customer. This value does not affect possible hysteresis settings in the GUI.

The fields “MDC1 Offset” and “MDC1 Gradient” can be used to rescale the Process Data in the IO-Link Master control tool, e.g. to allow conversion to units outside the SI unit system. This must not be confused with SSP Scaling coefficients (section 3.6.2.3).



### 3.6.6.3. Output Data

Depending on Generator Control settings, the output folder contains different output files:

#### IODD: XML file

The IODD XML file is always generated. If checking is set in the “Mode” option, this file contains a valid CRC stamp. The XML file name is structured as follows:

*VendorName-DeviceName-YYYYMMDD-IODD1.1.xml*

(example: *Renesas-ZSSC3286KIT-20241016-IODD1.1.xml*)

#### IODD: Image files (PNG files)

If specified, the image files are copied from the referenced path to the output directory. Without changing the file names of the referenced files (original files), the images are renamed according to IODD Generator input and settings.

#### IODD: ZIP file

If ZIP is set in the “Mode” option, this ZIP archive contains the IODD XML file and, if specified, the referenced image files. The XML file name is structured as follows:

*VendorName-DeviceName-YYYYMMDD-IODD1.1.zip*

(example: *Renesas-ZSSC3286KIT-20241016-IODD1.1.zip*)

#### iodd\_checker.log

If checking is set in the “Mode” option, the IODD Checker creates a log file containing the tests and test results of the checked IODD and a summary of the check.

#### ioddSettings.json

This file contains the attribute values for IODD Generator for the created IODD. It can be used to run the IODD Generator directly, without the GUI.

### 3.6.6.4. Error Handling

If the IODD file generation fails, an error message is displayed reflecting either of the following sources:

- GUI
- IODD Generator
- IODD Checker.

The error and additional details are saved into the GUI’s Communication log file.

#### 3.6.6.4.1. Errors from the GUI

If the GUI fails to create the JSON settings file, the most probable reason is either the lack of proper permissions to create the file in the specified directory or that the specified output directory is invalid, see Figure 141 as an example.

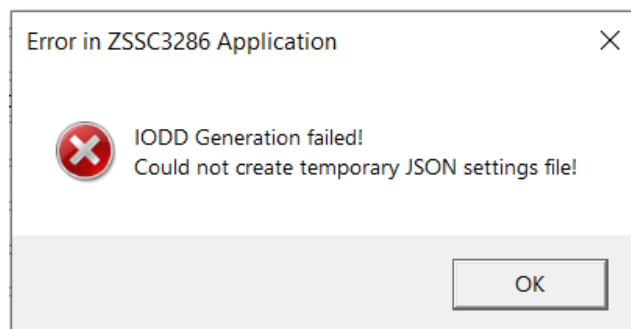
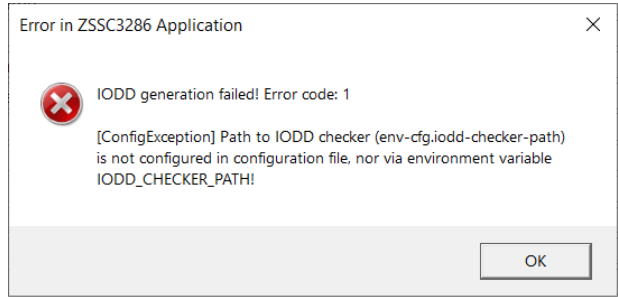

Figure 141. Error Message from GUI

### 3.6.6.4.2. Errors from the IODD Generator Tool

The IODD Generator tool does not proceed the IODD file generation if a validity check occurs of the received JSON configuration file.



Invalid IODD Checker path

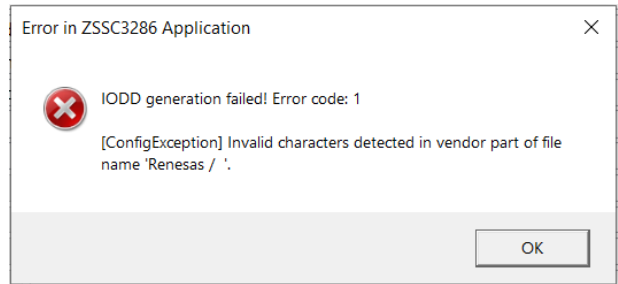

Invalid characters in the Vendor Name parameter

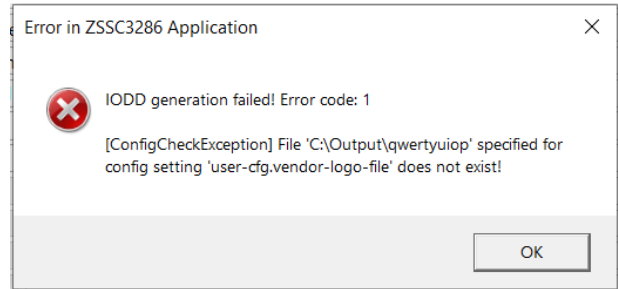

Invalid path to the Vendor Logo image file

Figure 142. Error Message Examples from IODD Generator (JSON Configuration File Errors)

**3.6.6.4.3. Errors from the IODD Checker**

If the IODD Checker detects that the IODD file does not conform to the IODD specification, an error message is generated (see Figure 143) and the error is logged into the IODD Checker log file. Warnings in the log file can be ignored.

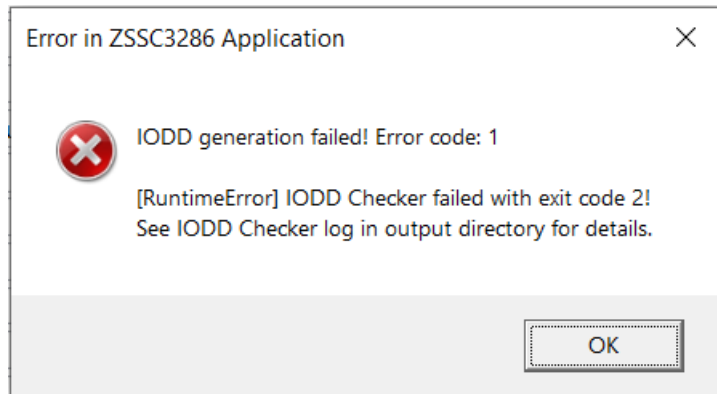

**Figure 143. Error message from IODD Checker**

The following example is from the IODD Checker log file showing error details:

```

=====
IO Device Description Checker V1.1.9
Checks an IODD V1.1.3 for syntax and semantic errors
Copyright (c) 2015-2022 by IO-Link Community
=====
Checks file : C:\Output\Renesas-DeviceName-20240930-IODD1.1.xml

XMLReader: Begin Check.....
XMLReader Validation: no errors

Business rules: Check .....
test case : "NewestChecker" : ok
test case : "File name convention of IODD" : ok
test case : "File name convention and format of linked files" : errors occurred
  line 692 column 76 : error : wrong size 'Renesas-DeviceName-con-pic.png' : 160
x 160 up to 320 x 320 pixel required
test case : "Read data structures" : ok
test case : "Profile header" : ok
test case : "productId" : ok
test case : "StdVariableRef" : warnings occurred
[...]
```

**3.6.6.4.4. IODD Generator Tool Availability Check**

At startup, the GUI verifies if the IODD Generator tool is available and can be run. External factors (for example, corruption of the GUI files after installation) or interference by other applications (for example, misconfigured antivirus software) could prevent the IODD Generator tool from executing. If the IODD Generator tool is not able to run, the GUI displays a warning message at the bottom of the IODD Generator tab, see Figure 144.

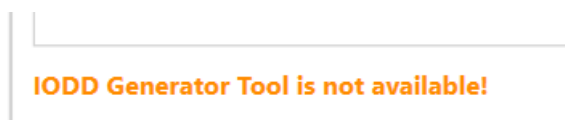

**Figure 144. Warning Message: IODD Generator is not Available**

### 3.7 Measure Tab

The Measure tab (Figure 145) provides a comprehensive overview of the measurement visualization settings and the option to save acquired data to a file.

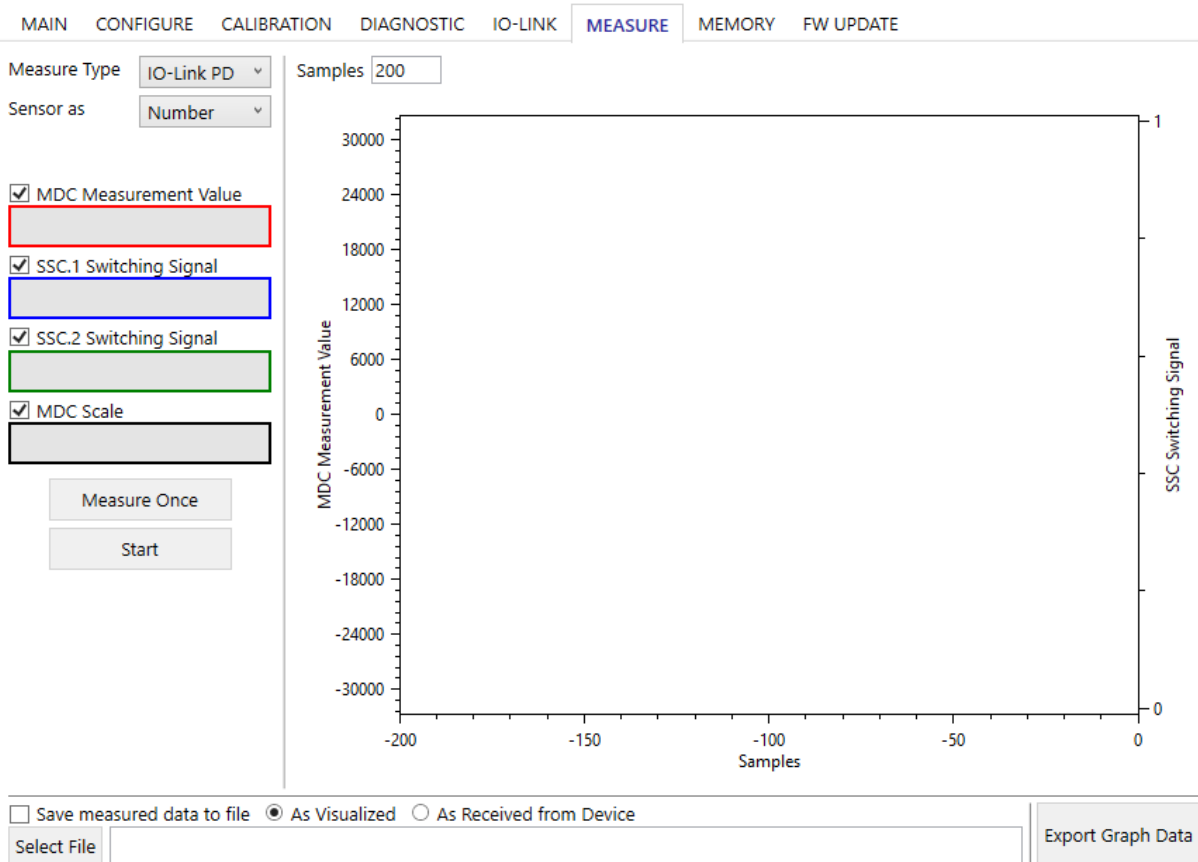

Figure 145. Measure Tab

#### 3.7.1. Measure Options

##### 3.7.1.1. Measure Type

Select Measure Type option from the “Measure Type” drop-down list (see Figure 146):

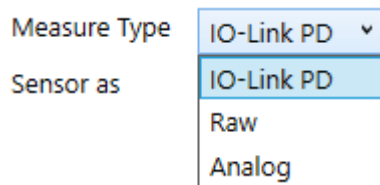

Figure 146. Measure Type

- IO-Link PD: Data is acquired from IO-Link Process Data (PD) within the Smart Sensor Profile (SSP). SSP 4.1.1 features a 16bit measurement value and two Sensor Switching Channels.
- Raw: Data is acquired through a specific set of reading commands. Raw data is mathematically unconditioned data.
- Analog: If Analog is selected and J46 on the ZSSC3286 EVB is shorted, the analog output is connected to a 10bit ADC input available on the CB, allowing analog data to be displayed.

Table 8 lists the availability of Measure Types depending on the interface used for connection to the EVB.

**Table 8. Measure Type Availability**

Measure Type	IO-Link	I2C (via CB)
IO-Link PD	✓	n.a.
Raw	✓	✓
Analog	n.a.	✓ J46 placed on EVB

**3.7.1.2. Sensor as & Temperature as**

The “Sensor as” drop-down list allows the visualization of data according to the options displayed in Figure 147.

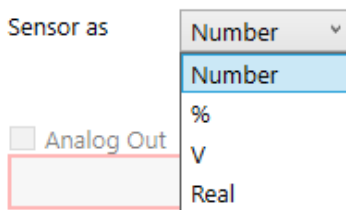

**Figure 147. “Sensor as” Options for “Analog”**

The “Temperature as” drop-down list allows the visualization of data according to the options displayed in Figure 148.

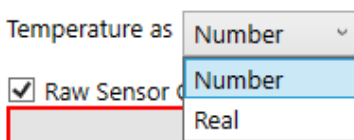

**Figure 148. “Temperature as” Options for “Raw”**

Table 9 lists the availability and data representation format of “Sensor as” and “Temperature as” options.

**Table 9. Data representation format: Sensor as/Temperature as**

Sensor as/ Temperature as	Measure Type		
	IO-Link PD	Raw	Analog
<b>Sensor as</b>			
Number	bit range according to SSP SSP 4.1.1: 16bit	$-2^{x-1} \dots +2^{x-1}$ range, with x: 10...24 bit	$0 \dots 2^{10}$ range (0...5V range)
%	n.a.	Data scaled to 0...100% range	Data scaled to 0...100% range (0...1V range)
V	n.a.	n.a.	Data displayed in Volts (0...1V range)
Real	n.a.	Data scaled to -1...+1 range	Data scaled to 0...+2 range (0...1V range)
<b>Temperature as</b>			
Number	n.a.	$-2^{x-1} \dots +2^{x-1}$ bit range, with x: 10...24 bit	n.a.
Real	n.a.	Data scaled to -1...+1 range	n.a.

### 3.7.1.3. Channel Display Selection

When marking a check box and clicking on the “Start” button, the corresponding numerical field shows the data from the selected sources, and the data is displayed in the graphs area. Availability and accessibility of sources varies depending on AFE configuration and Measure Type selection, see Figure 149, Figure 150 and Figure 151.

Figure 149. Display Selection for Measure Type “Raw”

Figure 150. Display Selection for Measure Type "IO-Link PD"

Figure 151. Display Selection for Measure Type "Analog"

### 3.7.1.4. Measurement Acquisition

The GUI offers the following options for measurements acquisition (Figure 152):

- single measurement acquisition (“Measure Once” button),
- continuous acquisition (“Start” button).

Figure 152. Measurement Acquisition

### 3.7.2. Graphs Area

The graphs area (Figure 153) allows visualizing, the trend of the acquired data as selected. The number of samples displayed in the graph can be configured in the “Samples” field. For Measure Type “Raw”, the resolution for Sensor and Temperature channels respectively can be chosen from the corresponding combo box (10bit to 24bit).

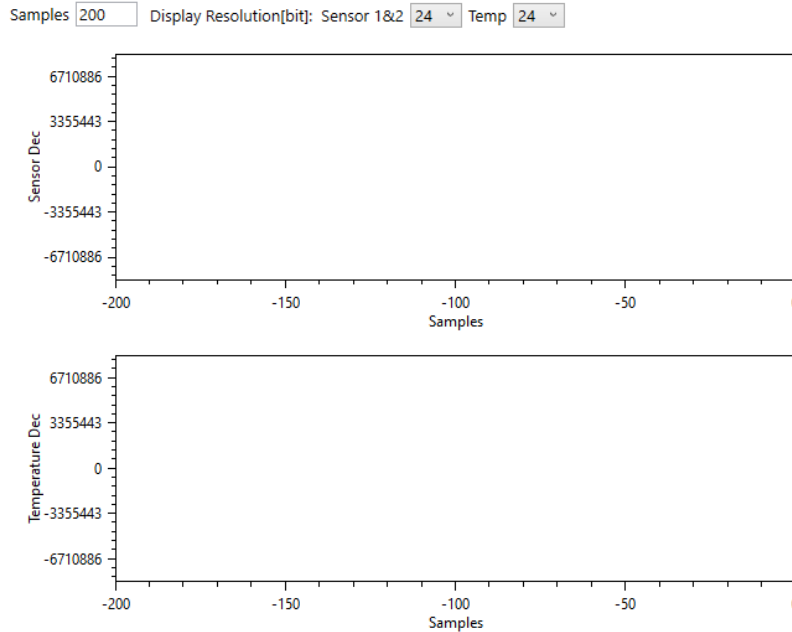

Figure 153. Graphs Area

### 3.7.3. Save Data

#### 3.7.3.1. Save Measured Data to File

By marking the check box “Save measured data to file” and clicking on the “Start” button, the acquired data is stored in the selected file (Figure 154). This offers the user the possibility to perform statistical analysis on data batches.

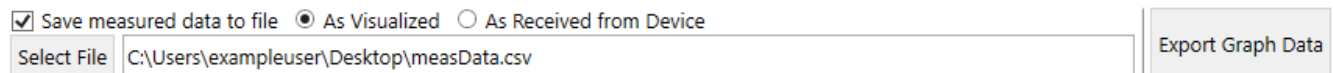

Figure 154. Save Measured Data

When “As Received from Device” is active, the data is saved in decimal format as received from ZSSC3286 without any further manipulation by the GUI.

When “As Visualized” is active, the data is saved in decimal format according to the display resolution selected (Figure 155), thus as displayed in Channel Display Selection field.

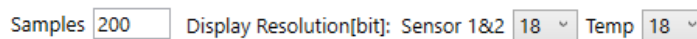

Figure 155. Selected Display Resolution

Table 10 lists the stored data format depending on selected Measure type.

Table 10. Stored Data Format

Save Data Option	Measure Type		
	IO-Link PD	Raw	Analog
As Received from Device	Bit range according to SSP SSP 4.1.1: 16bit value	24bit value with accuracy according to ADC resolution	10bit value (0...5V range)
As Visualized	no effect: Bit range according to SSP SSP 4.1.1: 16bit value	10...24bit value (LSBs cropped from received 24bit value)	10bit accuracy value according to “Sensor as” setting

### 3.7.3.2. Save Displayed Graph Data to File

To save the visualized data from graph to file, follow these steps:

1. Select the desired channel(s)/source(s).
2. Start measurement.
3. Stop the measurement when the desired data is displayed on the screen.
4. Click on the “Export Graph Data” button (Figure 156).
5. Browse and save the file to a location (Figure 156).
6. Click the “Save” button.

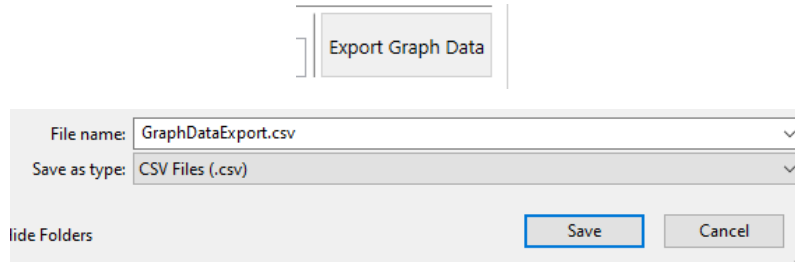

Figure 156. Save Displayed Data

## 3.8 Memory

### 3.8.1. Overview

The Memory tab provides the user a read-only view on the device configuration memory (NVM), see Figure 157.

MAIN	CONFIGURE	CALIBRATION	DIAGNOSTIC	IO-LINK	MEASURE	MEMORY	FW UPDATE
Reserved[0]	00	00000000	^	<b>View Register</b> Reserved[0]			
Reserved[1]	01	00000000		Hex Value <input type="text" value="00000000"/>			
PhyCfg1	02	004323E3		Bit Fields			
IoIMisc	04	00000006		Reserved[0] [31:0] <input type="text" value="0"/>			
AfeBaseCfgParam	05	00000001					
AfeBaseCfgParam.AfeDsCfg.Reg1	06	00000000					
AfeBaseCfgParam.AfeDsCfg.Reg2	07	00000000					
Bm1Cfg1	08	04000654					
Bm1Cfg2	09	00000210					
Bm2Cfg1	0A	04000656					
Bm2Cfg2	0B	00000210					
ExtTemp1Cfg1	0C	0011C5F1					
ExtTemp1Cfg2	0D	00000210					
ExtTemp2Cfg1	0E	00118502					
ExtTemp2Cfg2	0F	00000010					
ExtTemp3Cfg1	10	00118502					
ExtTemp3Cfg2	11	00000010					
AfeRegsAna.CmConfig[0]	12	00000000					
AfeRegsAna.CmConfig[1]	13	00000000					
AfeRegsAna.CmConfig[2]	14	00000000					
PtatCfg1	15	0000F533					
PtatCfg2	16	00000030					
Afe1MeasCfg1	17	01020036					
Afe1MeasCfg2	18	00000013					
Afe1MeasCfg3	19	00000018					
Afe1MeasCfg4	1A	00400000					
Afe2MeasCfg1	1B	01020036					
Afe2MeasCfg2	1C	00000013					
Afe2MeasCfg3	1D	00000300	v				

Figure 157. Memory Overview



The complete set of registers composing the device configuration memory is listed in a Memory map. Each register is associated with a mnemonic, an address, and the relevant content (in hexadecimal value) as displayed in Figure 158.

Bm1Cfg1 08 04000655

Figure 158. Register

### 3.8.2. View Register

To have a detailed view of the register content, the register can be selected via the list on the left side of the tab or via the “View Register” drop-down list (Figure 159).

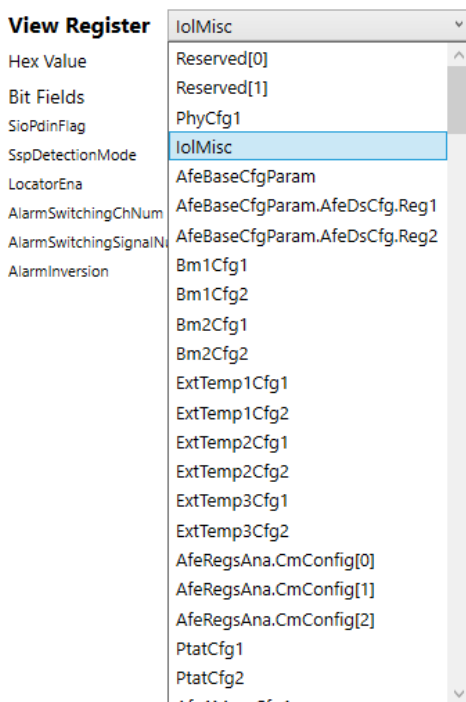

Figure 159. Memory – View Register via Drop-Down List

For the selected register, the relevant values are displayed and the bit fields associated with specific functions or functionalities are listed (Figure 160 shows an example register: the values are accessible in read/write through the Configure and Calibration tabs described in section 3.3.10).

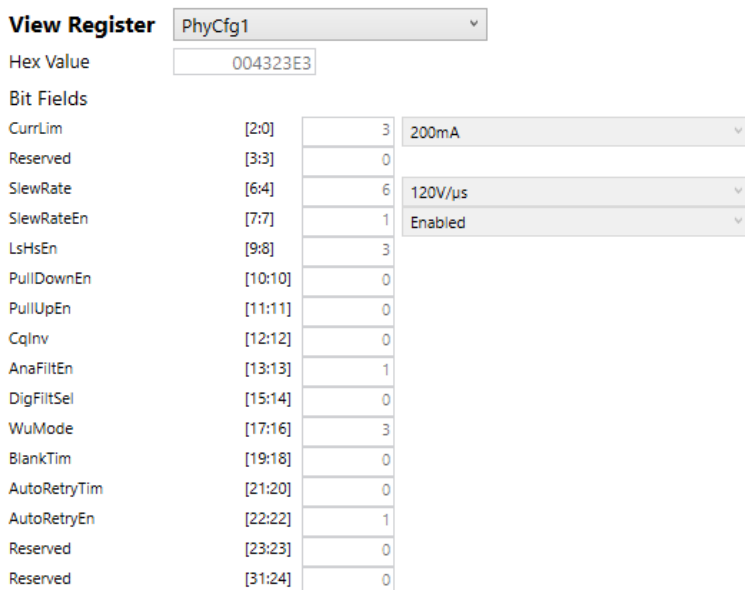

Figure 160. Register Content

Changes to the configuration of the device are highlighted in the Memory map in red. A Write Memory operation must be performed for the changes to take effect. In the “View Register” section, it is possible to check the bits of the registers that were affected by a change (Figure 161).

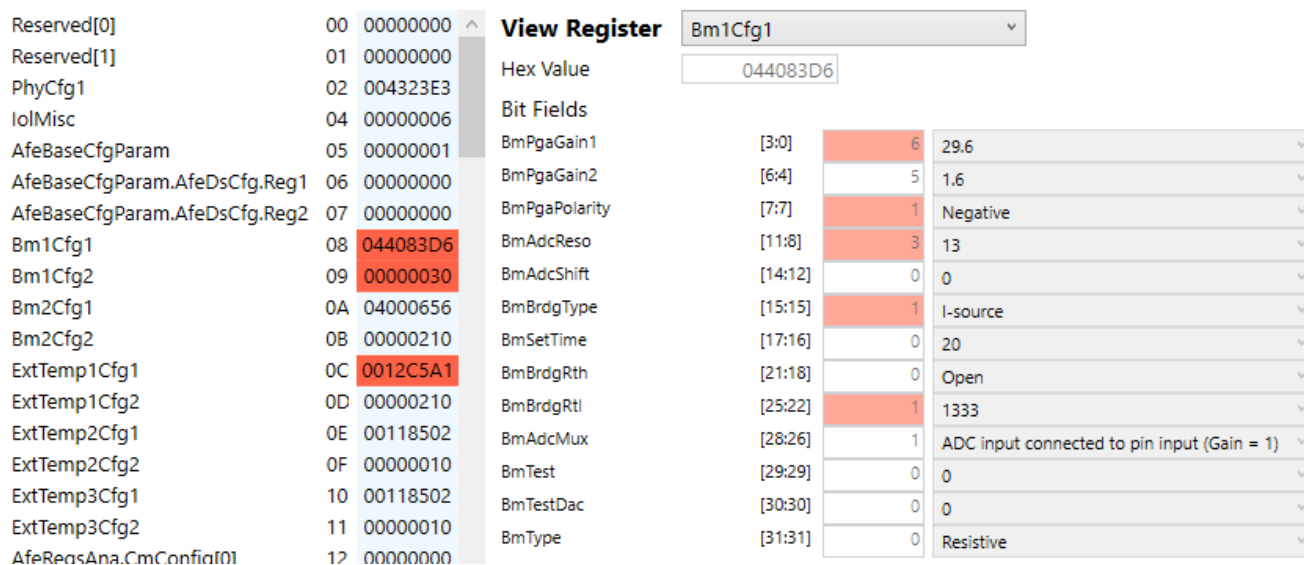

Figure 161. Modified Bits in a Register – Changes not Written to NVM

### 3.9 FW Update Tab

This tab allows updating the ZSSC3286 Firmware via either IO-Link or I2C.

**Note:** It is highly recommended to make a copy of the NVM configuration settings (section 3.1.1.1) before performing a FW update.

**IMPORTANT NOTE:** Ensure a stable power supply during update. Power loss during update may cause corruption of the device.

Follow these steps to update the firmware:

1. Click on “Select File” and choose the correct FW Update file in IOLFW or BIN format. Once the file is chosen, the GUI displays its meta data (Figure 162 shows an example). If the FW Update file is valid, the GUI shows “Ready to perform firmware update” at the bottom of the tab.

```

Release Date: 2024-07-30
File Version: V1.0
Copyright: Renesas Electronics Europe GmbH
Vendor Name: Renesas
Vendor ID: 396
Firmware Revision: 1.0.0
-----
Hardware ID Key: TO_BE_FILLED
Product ID:
Product Name:
    
```

**Figure 162. Firmware Meta Data**

2. Click on Start Firmware Update. The GUI runs either of the following FW Update procedure:
  - via I2C: Figure 163 shows the progress pop-up window during FW Update.
  - via IO-Link: Figure 164 shows the progress pop-up window during FW Update.

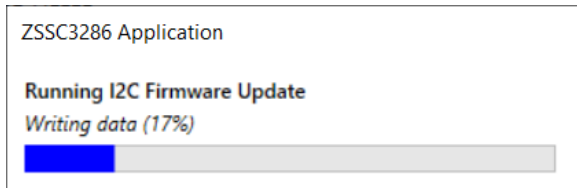

**Figure 163. I2C FW Update Progress**

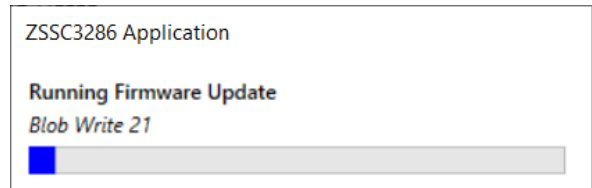

**Figure 164. IO-Link FW Update Progress**

After successful data write, the ZSSC3286 is restarted and either of the following message is shown:

- update via I2C: Figure 165 shows the confirmation pop-up window for successful FW Update.
- update via IO-Link: Figure 166 shows the confirmation pop-up window for successful FW Update.

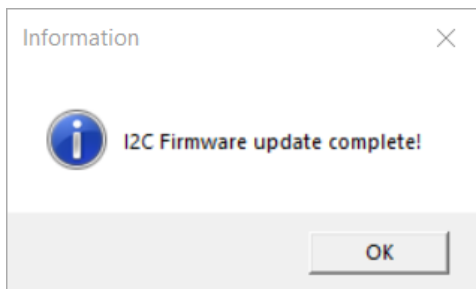

**Figure 165. I2C FW Update Success Message**

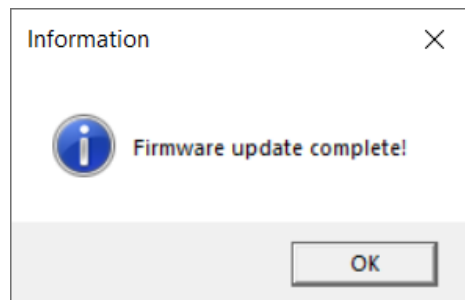

**Figure 166. IO-Link FW Update Success Message**

### 3.10 Command Console

The Command Console can be started as described in section 3.1.1.3 (Figure 167). Commands can be written directly to the CB allowing direct write and read commands for the ZSSC3286 via I2C. The device response is received in the result display.

The list of CB commands is available upon request.

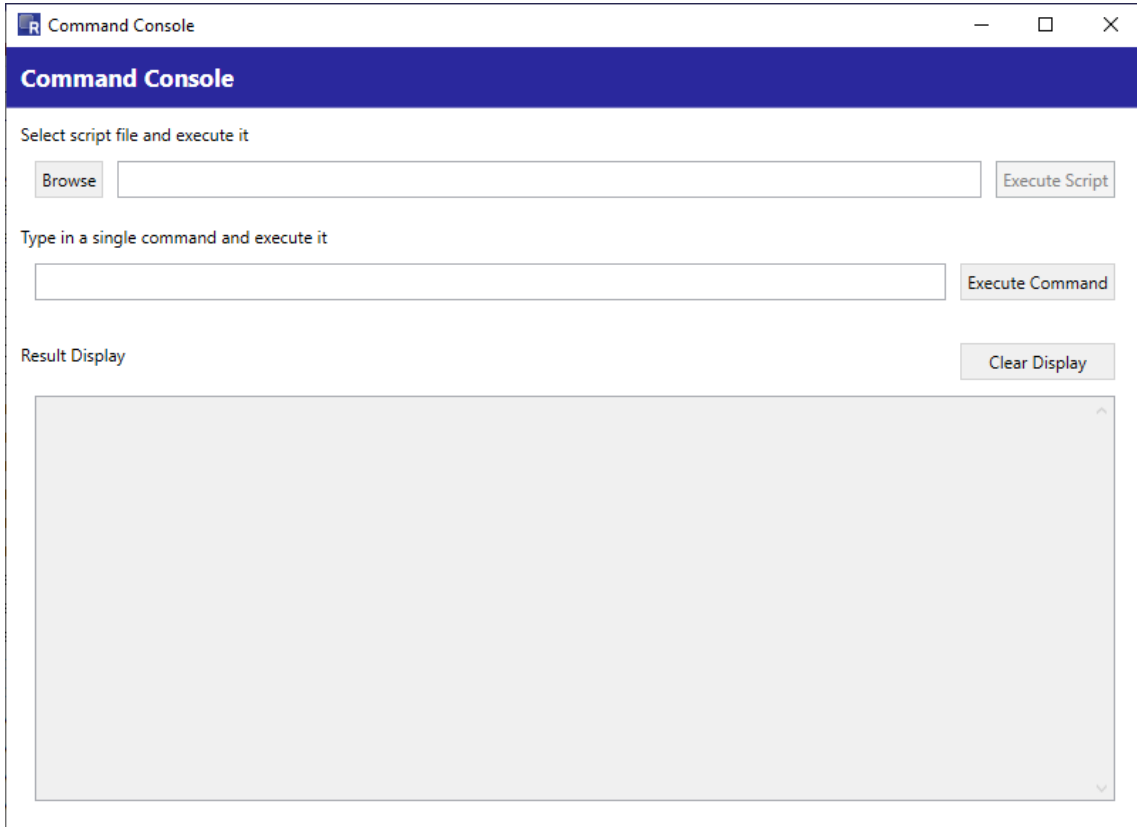

Figure 167. Command Console Pop-Up Window

#### 3.10.1. Select Script and Execute

A previously edited script file, containing a commands sequence, can be loaded and executed directly by clicking the “Browse” button, selecting a file, and clicking the “Execute Script” button as shown in Figure 168.

The script file must be a text file with valid commands.



Figure 168. Script Execution

#### 3.10.2. Type Single Command and Execute

A single command can be typed using the entry field and executed with “Execute Command” button shown in Figure 169.



Figure 169. Single Command execution

### 3.10.3. Result Display

The result of the execution of a command is returned in the area displayed in Figure 170. The output data of the ZSSC3286 can be marked and copied to clipboard via a context menu (for example, for further analysis).

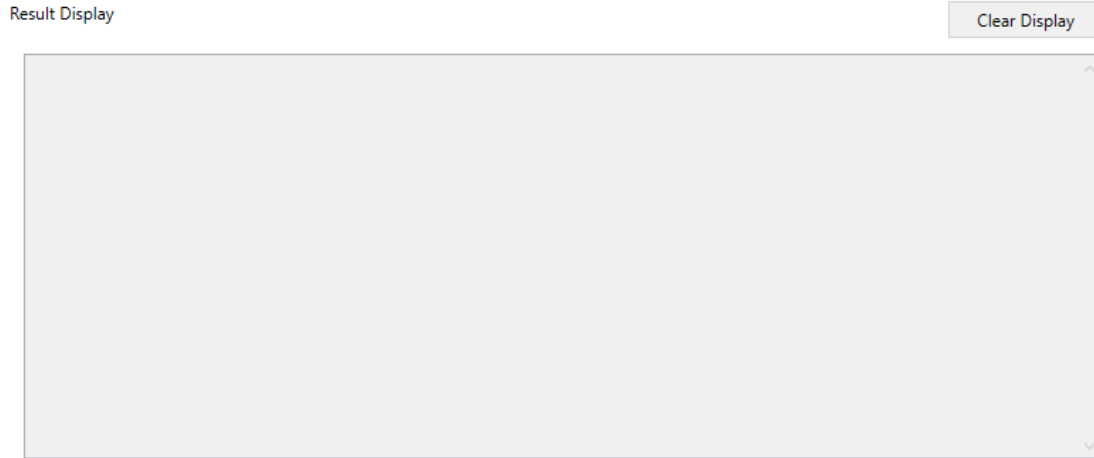

Figure 170. Command Execution Result

### 3.10.4. Clear Display

The Result Display area can be cleared using the “Clear Display” button (Figure 171).

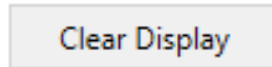

Figure 171. Clear Display

## 4. GUI and FW Revision References

GUI Revision	FW Revision
1.0.2	1.0.0

## 5. References

Reference Number	Title
1	SSC-CB Datasheet available at: <a href="https://www.renesas.com/SSC-CB">https://www.renesas.com/SSC-CB</a>
2	RH4Z2501-PMOD Evaluation Board Manual available at: <a href="https://www.renesas.com/RH4Z2501-PMOD">https://www.renesas.com/RH4Z2501-PMOD</a>
3	ZSSC3286 Datasheet available at: <a href="https://www.renesas.com/ZSSC3286">https://www.renesas.com/ZSSC3286</a>
4	RH4Z2501 Datasheet available at: <a href="https://www.renesas.com/RH4Z2501">https://www.renesas.com/RH4Z2501</a>

## 6. Glossary

Term	Description
AFE	Analog Front End
AUX	Auxiliary
CB	SSC Communication Board V4.1
C/Q	C/Q line of IO-Link interface. Connection for communication (C) or switching (Q) signal.
DC	Direct Current
DC-DC	Direct Current - Direct Current
ESD	Electrostatic Discharge
EVB	Evaluation Board
FW	Firmware
GND	Ground
GUI	Graphical User Interface (Renesas ZSSC3286 Application)
IC	Integrated Circuit
IO, I/O	Input Output
IODD	IO-Link Device Description
LDO	Low Drop Out
LED	Light Emitting Diode
MCU	Microcontroller
MDC	Measurement Data Channel
n.a.	not applicable
NPN	Negative-Positive-Negative
NTC	Negative Temperature Coefficient
NVM	Non-Volatile Memory
OWI	One Wire Interface
PC	Personal Computer
PCB	Printed Circuit Board
PD	Process Data
PHY	Physical Layer
PMOD	Digilent Pmod™ Connector
PTC	Positive Temperature Coefficient
QFN	Quad Flat No Leads Package

SM+, SM-	Sensor Measurement Positive, Sensor Measurement Negative
SRB	Sensor Replacement Board
SSC	Sensor Signal Conditioner
SSP	Smart Sensor Profile
TLC	Third Logic Channel

## 7. Revision History

Revision	Date	Description
1.2	Feb.28, 2025	Evaluation Software version update; explanation of I/O Functions; Kit hardware setup picture
1.1	Jan.24, 2025	Evaluation Software version update
1.0	Oct.9.24	Initial release.