

RAA215300 Evaluation GUI

This manual provides installation procedures, features, and user information for the graphical user interface (GUI) evaluation software used by the [RAA215300](#) and evaluation board.

Contents

1. System Requirements	2
2. Software Installation	2
3. Using the Software	5
3.1 Open Software	5
3.2 Evaluation Software Initialization	5
3.3 Device/Slave Address	6
3.4 RAA215300 Specific GUI Tabs and User Controls	7
3.4.1 Buck1-6 Tabs	7
3.4.2 LDO1-3 Tabs	7
3.4.3 Fault Configuration and Reporting Tabs	8
3.4.4 MPIO Tab	9
3.4.5 Config1/Status and Config2 Tabs	9
3.4.6 RTC Tab	10
3.4.7 Auxiliary Controls	10
3.5 Supplementary Support Features	11
3.5.1 File Menu	11
3.5.2 HID Status and Connection	12
3.5.3 I ² C ACK/NACK	12
3.5.4 Find Device/Slave Address(es)	13
3.5.5 Write All	13
3.5.6 Read All	13
3.5.7 I ² C Log and Script	14
3.6 General Tab	15
3.6.1 Manual Transaction	15
3.6.2 USB Dongle Setup	16
3.6.3 16-Bit Converter Tool	17
3.6.4 Register Dump	17
3.6.5 Auto Write Selection	17
4. Software Uninstall Process	18
5. Troubleshooting Tips	18
6. Revision History	19

1. System Requirements

Following are the minimum system requirements for the evaluation software.

- **Operating System:** PC or virtual Windows machine with Windows 7 or greater
- **.NET Framework:** 4.5 or greater, and 3.5 (CLR 2)
- **RAM:** 100MB RAM
- **Hard Disk:** 10MB free disk space

Note: No special drivers are required for the Renesas USB Dongle (ISLUSBMINIZEVAL1Z), it operates as a Human Interface Device (HID).

2. Software Installation

The following steps describe installing the PC software.

Note: This evaluation software is a single evaluation tool for all RAA215300 evaluation boards.

1. Download the installer file from the [website](#) or from the USB drive.
2. The installer file named RAA215300_Installer_vX.Y.Z.exe, where X.Y.Z is the version number of the evaluation software, is downloaded into the system or user designated download folder.
3. Run the installer file.
4. Follow the installation wizard to install the evaluation software.
5. Read the license agreement, choose the accept option, and click **Next** to continue with the evaluation software installation.

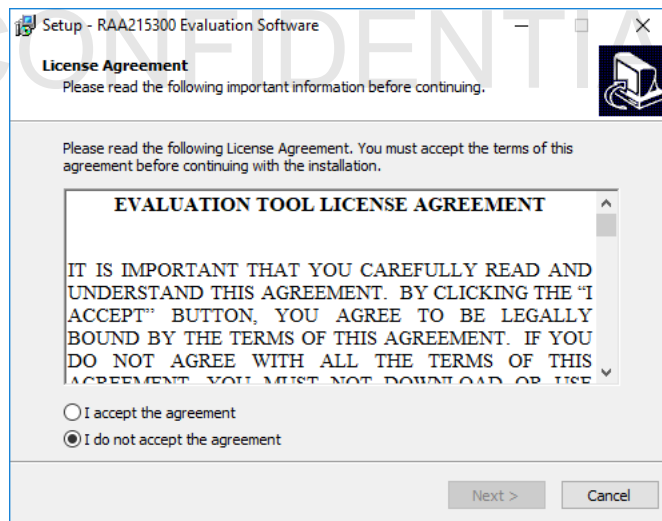

Figure 1. License Agreement

6. The default directory is C:\Program Files (x86)\Renesas\RAA215300.

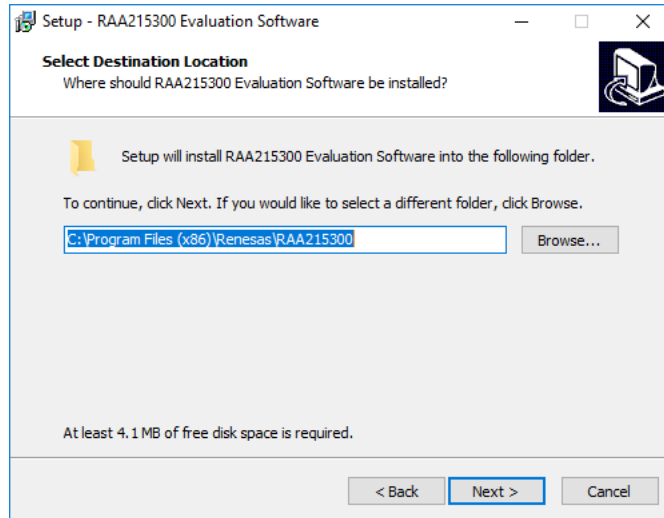

Figure 2. Select Evaluation Software Installation Folder

7. To change the default location, click the **Browse** button. Click **Next** to continue to the Select Start Menu Folder. Create the Renesas folder in the Start Menu. Click **Next** to continue to Ready to Install.

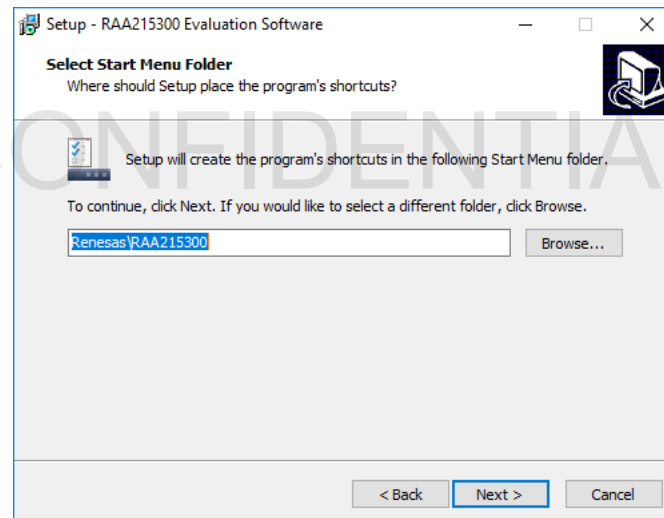

Figure 3. Select Start Menu Folder

8. Click **Install** to complete the installation process.

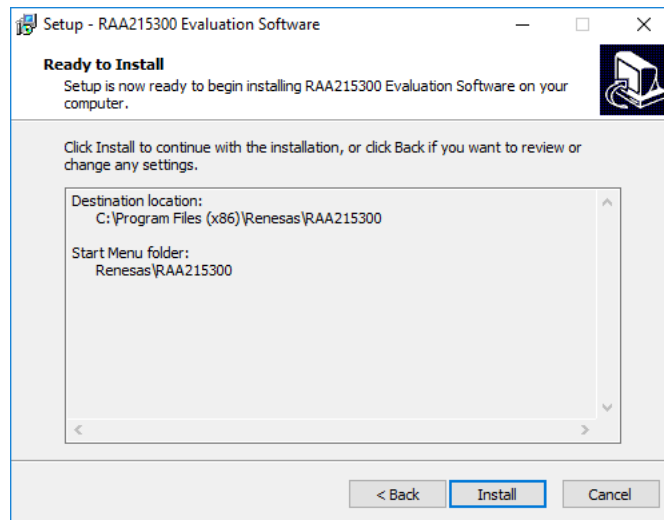

Figure 4. Ready to Install

9. Click **Finish** to exit setup. If the **Launch RAA215300** check box is selected, the evaluation software automatically runs.

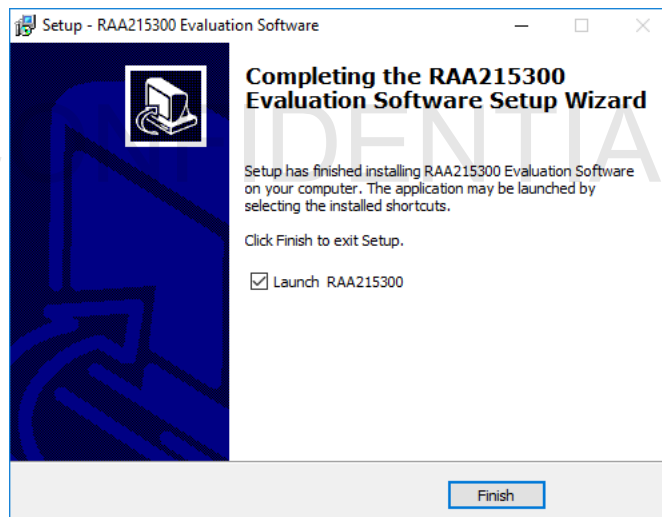

Figure 5. Exit Setup

3. Using the Software

3.1 Open Software

Open (run) the evaluation software from the Windows Start menu. Unless changed during the installation process, the program resides under the Renesas folder.

3.2 Evaluation Software Initialization

During initialization, an attempt is made to establish connection to the HID dongle (ISLUSBMINIEVAL1Z). If the connection is successful, the main GUI form opens and the HID Status button turns green.

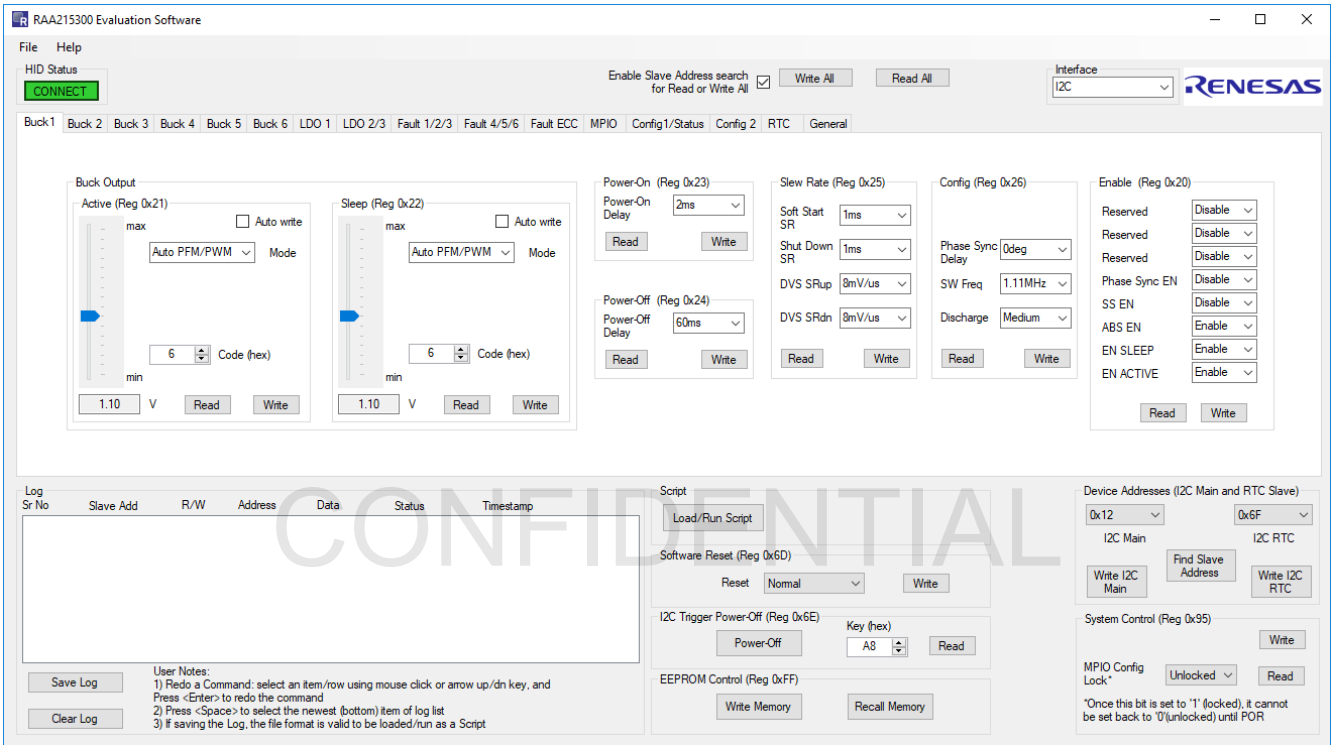

Figure 6. Default Evaluation Software GUI

Figure 7 shows the Renesas HID dongle.

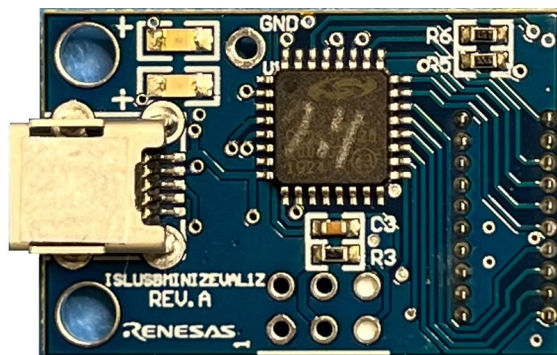

Figure 7. Renesas ISLUSBMINIZEVAL1Z HID Dongle

If the connection attempt is unsuccessful, a warning message appears (see [Figure 8](#)) before the main GUI form is displayed.

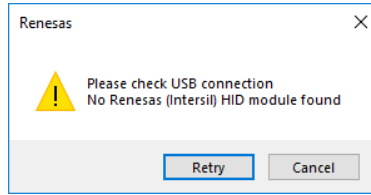

Figure 8. No HID Dongle Error Message

After the dongle is connected to the PC, click **Retry**; if successful, the default GUI form displays (see [Figure 6](#)). Alternatively, clicking **Cancel** closes the warning message and opens the main GUI form to run in off-line mode, where no serial communication can occur until the HID connection is successfully (re)established.

3.3 Device/Slave Address

The first step after installing the evaluation software is to click **Find Slave Address**. The find slave address routine searches the potential address(es) for the IC and sets the found valid address(es) to the GUI (see [Find Device/Slave Address\(es\)](#)). When the routine completes, a message box appears to report the detected slave address (see [Figure 9](#)), or to indicate that no address was found (see [Figure 10](#)).

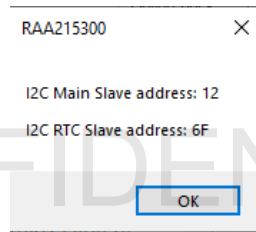

Figure 9. Slave Address Found

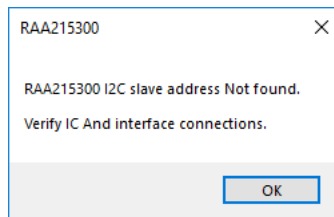

Figure 10. Slave Address Not Found

3.4 RAA215300 Specific GUI Tabs and User Controls

3.4.1 Buck1-6 Tabs

The GUI tabs, titled accordingly, display the output voltage targets and the configuration settings for each buck regulator. The GUI layout is identical (see Figure 11) across all Buck tabs for consistency and ease of use.

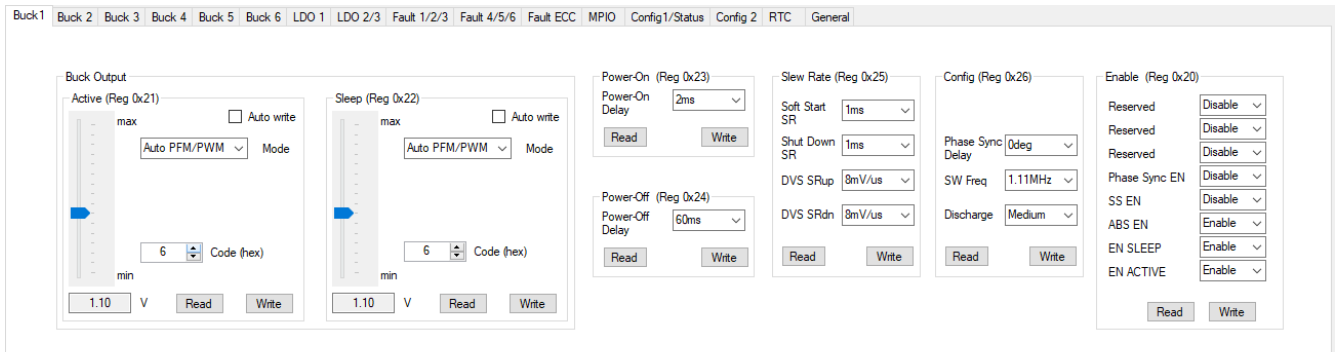

Figure 11. Buck1 Tab

The output voltage target is set using a sliding track bar for intuitive voltage increase/decrease adjustment. The track bar can be adjusted by clicking and dragging the bar. Likewise, it also supports mouse wheel scroll (the size of steps are determined by the Windows mouse scroll settings), PgUp/PgDn keys for a large change ($\pm 0 \times 10$), and arrow Up/Down keys for small change ($\pm 0 \times 1$). The output voltage code setting can also be adjusted directly in the relative numeric up/down text box.

The **Auto write** check box determines if output voltage changes are automatically written to the IC (checked), or the user needs to manually click **Write** after making an adjustment to the voltage target(s) (unchecked, default).

3.4.2 LDO1-3 Tabs

The LDO regulator's output voltage targets and configuration settings are contained on two GUI tabs (LDO1 Tab for LDO 1, and LDO2/3 tab for both LDO2 and LDO3 configuration settings).

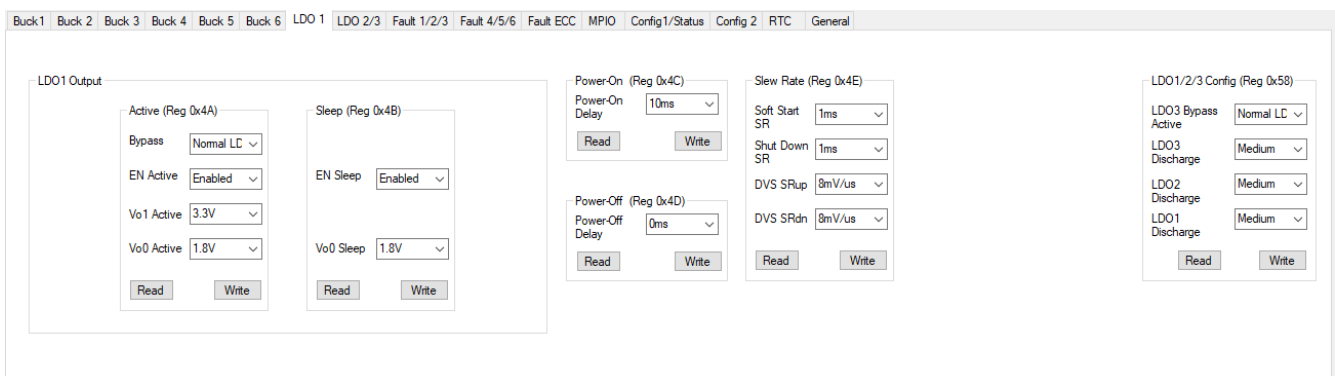

Figure 12. LDO1 Tab

3.4.3 Fault Configuration and Reporting Tabs

All fault configuration and status reporting reside on three GUI tabs (Fault1/2/3 Tab, Fault4/5/6, and Fault ECC).

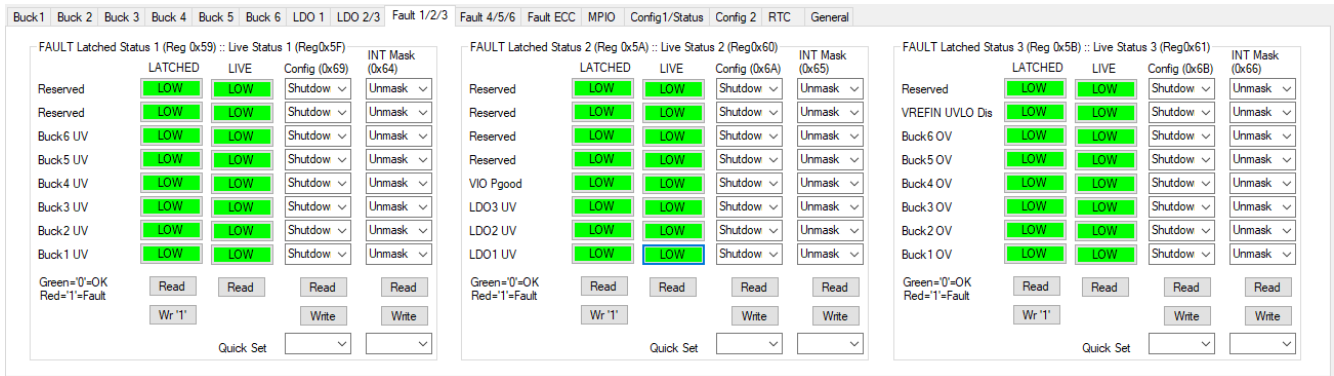

Figure 13. Fault1/2/3 Tab

Fault status reporting features both textual labels and color feedback for quick view/assessment. Green = Good/normal, Red = Bad/fault. Figure 14 shows how the GUI would report an active and uncleared undervoltage (UV) fault on Buck1. For faults that feature a Write 1 to clear mechanism, the user can click to toggle HIGH/LOW the required fault bit and click the respective **Wr '1'** button to write the register.

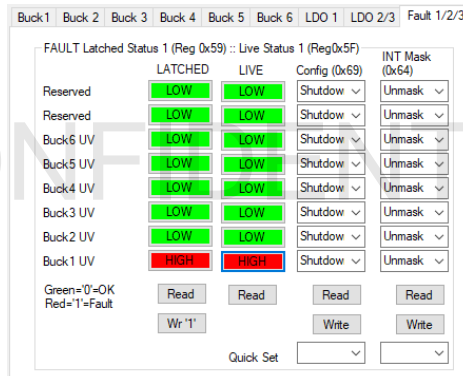

Figure 14. Example - Buck1 UV Fault

3.4.4 MPIO Tab

All the multiple purpose input-output (MPIO) configuration settings are all located on the MPIO Tab.

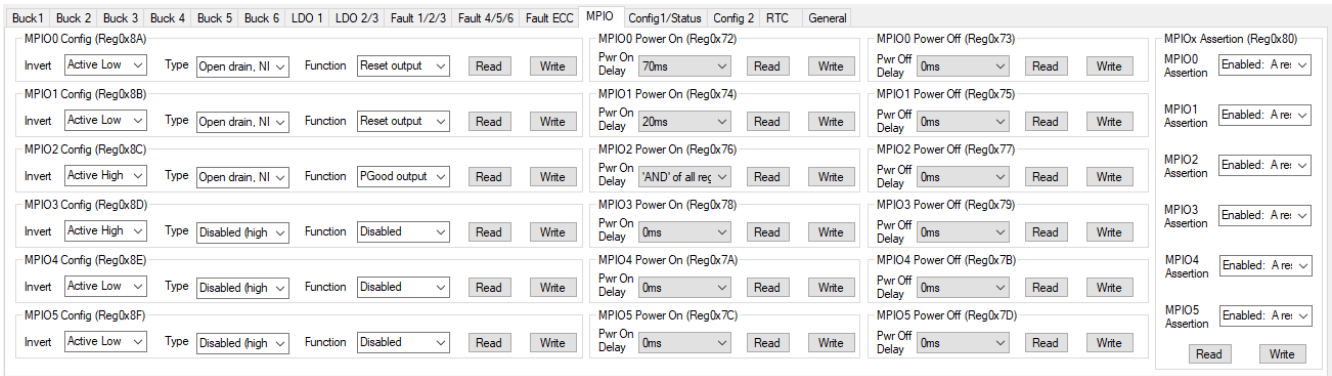

Figure 15. MPIO Tab

3.4.5 Config1/Status and Config2 Tabs

The general IC status and information registers reside on the Config1/Status Tab.

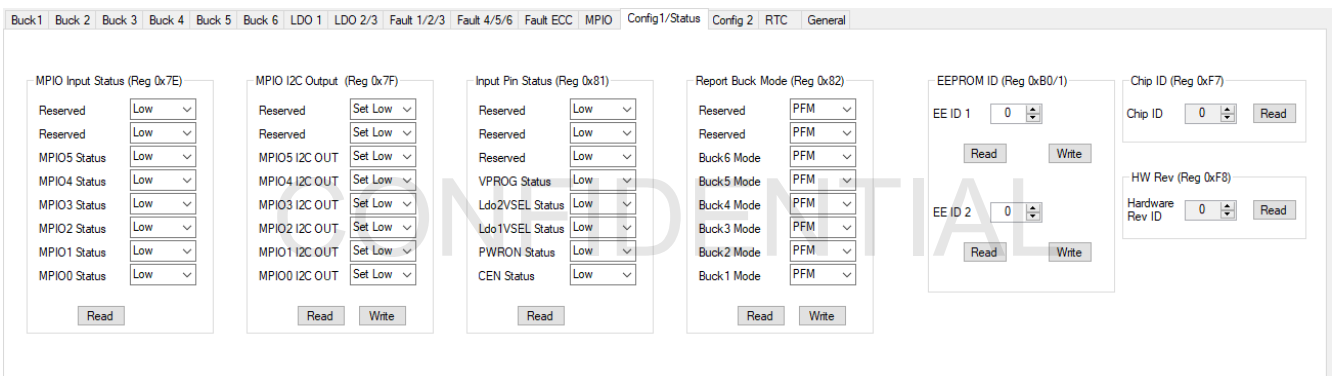

Figure 16. Config1/Status Tab

All remaining IC configuration settings reside on the Config2 Tab.

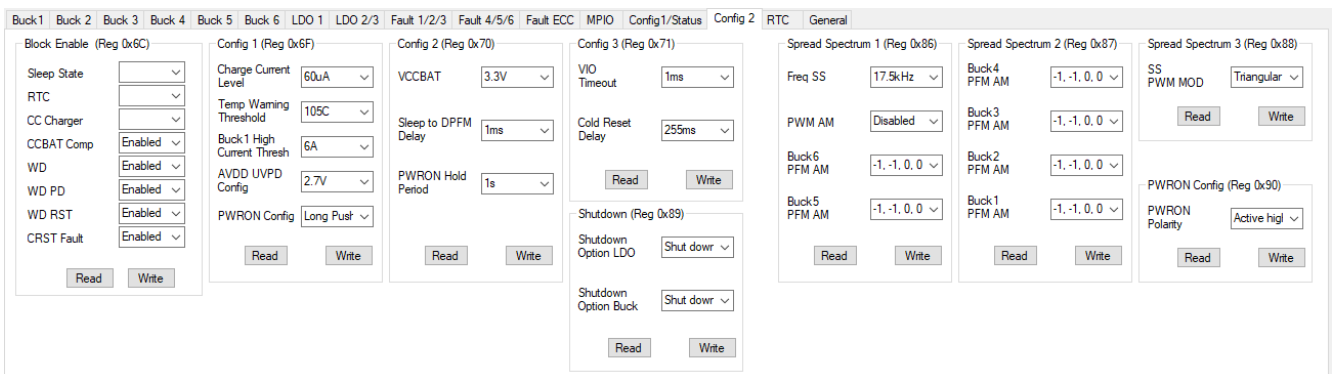

Figure 17. Config2 Tab

3.4.6 RTC Tab

One tab is dedicated to the real-time clock (RTC) timing and configuration settings. All registers on this tab use the I²C RTC slave/device address to communicate with the IC.

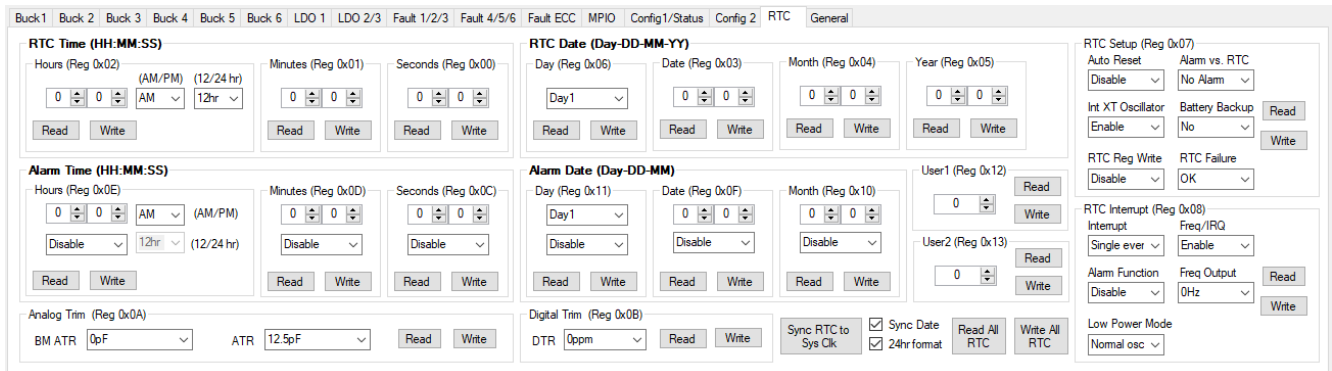

Figure 18. RTC Tab

To sample the current computer system clock time and set to the RTC registers, click **Sync RTC to Sys Clk**.

The GUI notifies the user if there is a suspected conflict in the RTC settings (for example, entered or read-back time data conflicts with the selected 12/24hr setting); however, it does not prevent the reading and displaying of incorrect times.

Note: To start and communicate to the RTC timing registers, ensure the **Int XT Oscillator** and **RTC Reg Write** settings in reg0x07 are enabled.

3.4.7 Auxiliary Controls

Various auxiliary IC controls are located in the bottom right vicinity of the GUI window.

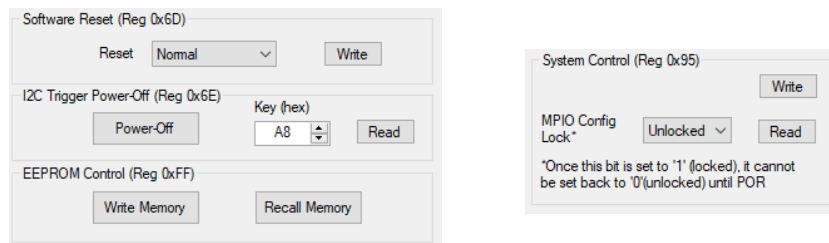

Figure 19. Auxiliary Controls

3.4.7.1 Software Reset

The software reset control provides selection for the type of reset to be triggered when the **Write** button is clicked.

3.4.7.2 I²C Trigger Power-Off

The I²C Trigger Power-Off control provides the ability to read-back the currently set I²C key value, in addition to choosing a different key. The key is sent to the IC when **Power-Off** is clicked.

3.4.7.3 EEPROM Control

Click **Write Memory** to initiate IC non-volatile EEPROM programming operations, where all current register values in the IC are copied to EEPROM.

Click **Recall Memory** to reload stored EEPROM values to the IC volatile registers. After a Recall Memory operation, Renesas recommends (re)synchronizing the GUI display with the IC registers, see [Read All](#).

3.4.7.4 System Control - MPIO Lock

The system control provides access to the MPIO configuration lock feature. When the lock is activated, the IC prevents MPIO configuration register settings from subsequent changes during the current IC power-on period. To reset (clear) the lock, the IC must be power cycled to trigger a power-on reset (POR).

3.5 Supplementary Support Features

The evaluation software has supplementary features such as data-logging and script execution, read and write of all registers, finding or changing a slave address, and others as shown in Figure 20.

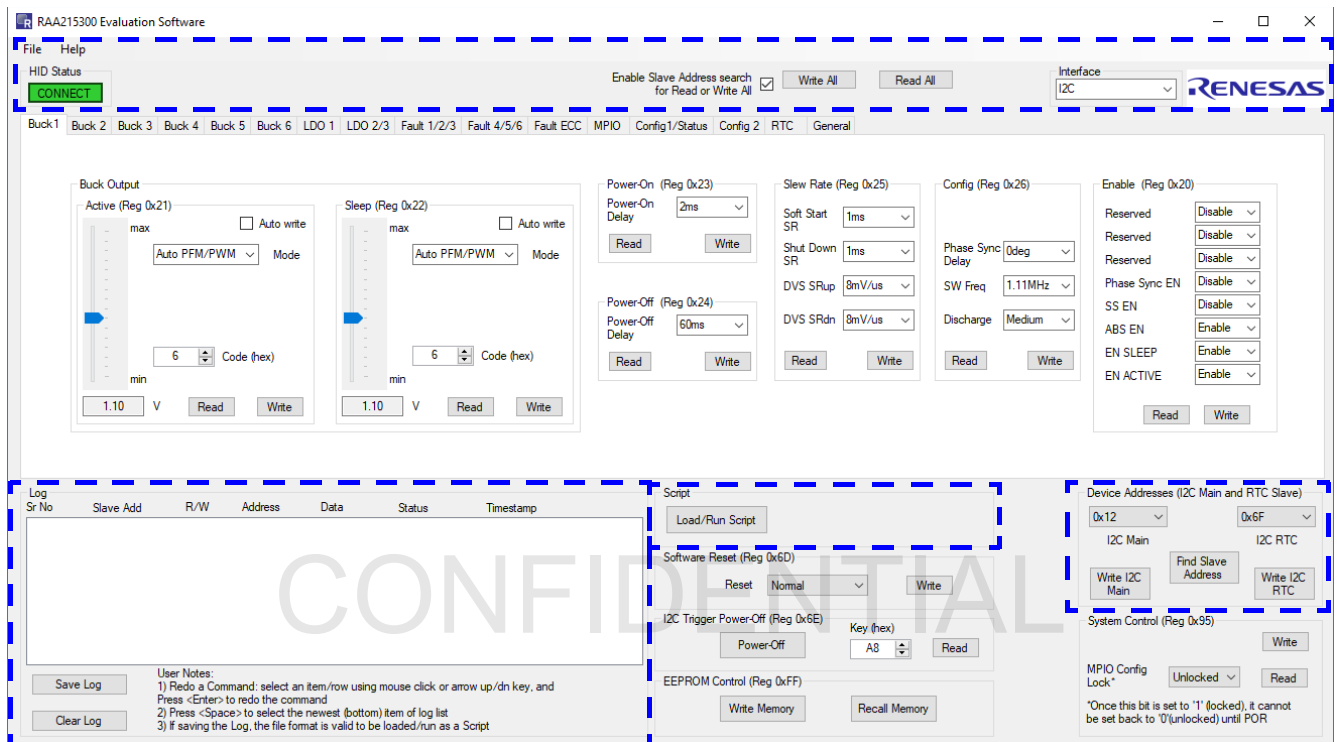

Figure 20. Supplementary Features

3.5.1 File Menu

3.5.1.1 Save

The **Save** option saves all the register settings, as currently shown in the GUI, into a text (load) file (see Figure 21).

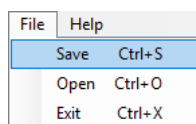

Figure 21. File > Save

The text file generated has 8-bit data values in hexadecimal format for the 0x00 to 0xFF register space. Each line of the text file corresponds to register address (n - 1). For example, line one of the text file contains data from register address 0, and line 256d contains data from register address 255d (0xFF).

It is acceptable to manually add notes or comments to any line in a text load file, placed after the 8-bit hexadecimal data value (two characters). **Note:** No special delimiters are required.

3.5.1.2 Open

The **Open** option (re)loads all the register settings from a properly formatted text load file into the evaluation software (see [Figure 22](#)) and updates the GUI display.

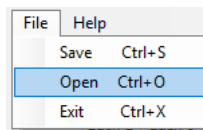

Figure 22. File > Open

Note: By default the evaluation software does not automatically write the data loaded from the text file into the IC registers. To write all register data, click **Write All** after **File > Open**. See [Auto Write Selection](#).

3.5.1.3 Exit

The **Exit** options closes the application window and exits the program. Functionally, this is the same as clicking the X in the upper right of the GUI window to close the program.

3.5.2 HID Status and Connection

The HID Status displays the state of the connection between the software/PC and Renesas HID dongle. The software automatically detects removal and insertion of the HID dongle to the PC. The **CONNECT** button is green when the HID dongle is connected, and red when disconnected. Clicking **CONNECT** resets and attempt to re-establish the HID connection.

If the dongle is disconnected while the evaluation software is running, a message box appears (see [Figure 23](#)). Click **Retry** to manually attempt to reconnect, or click **Cancel** to return to the GUI.

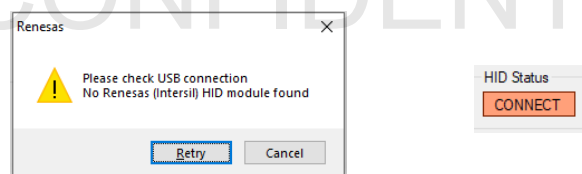

Figure 23. No HID Dongle

3.5.3 I²C ACK/NACK

Successful I²C communication contains acknowledge bits (ACK) at the end of each byte. No special notification or action is provided by the GUI for an ACK. However, the GUI monitors for unsuccessful I²C communication in the form of a not acknowledge (NACK) bit. If a NACK is encountered, the GUI notifies the user with a message box (see [Figure 25](#)), and generally terminates the current operation.

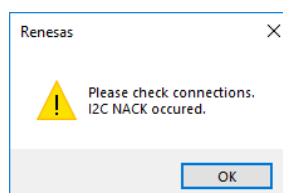

Figure 24. I²C NACK

3.5.4 Find Device/Slave Address(es)

This feature searches for an RAA215300 device on the I²C bus and sets the correct slave addresses to be used by the GUI. Click **Find Slave Address** to initiate the search. It searches for an I²C ACK by attempting I²C commands with incrementing slave address from 0x00 to 0x7F. If an address is ACK'd, the routine does a command sequence to verify an RAA215300 device.

If an RAA215300 device is located, it reads back the programmable slave addresses setting registers and set those values to the GUI, and a message box with the I²C slave addresses appears (see [Figure 9](#)). If the evaluation software cannot find the RAA215300 device on the bus, a message box with an error message appears (see [Figure 10](#)).

3.5.4.1 Address Change

It is possible to manually change the slave address for the RAA215300 Main or RTC address. Choose the new address from the pull-down list and click the respective write button to send a command to the IC to set the new address. If the command is ACK'd (successful), the GUI is updated to use the newly selected address. If the command is NACK'd (not successful), the GUI continues to use the current address.

This feature is not commonly used, but may be useful in system testing and debug.

3.5.5 Write All

The **Write All** button writes data to all the valid registers of the IC based on the settings shown on the evaluation software GUI. The currently selected slave address(es) in the GUI are used for the operation. If an I²C NACK is encountered the routine terminates immediately.

A check box option is provided to enable the I²C slave address search before executing the write all operation (see [Figure 25](#)).



Figure 25. Enable Slave Address Search for Read/Write All

3.5.6 Read All

The **Read All** button reads all the valid registers and updates the evaluation software GUI settings based on the read-back data from the IC registers, which synchronizes the IC/device under test with the GUI display. It is always recommended to read-all whenever the evaluation software is first run and/or a device under test is (re)started (such as power cycled, reset, or memory recalled). The currently selected slave address(es) in the GUI are used for the operation. If an I²C NACK is encountered the routine terminates immediately.

A check box option is provided to enable the I²C slave address search before executing the read all operation (see [Figure 25](#)).

3.5.7 I²C Log and Script

The evaluation software has a live I²C log that updates when an I²C read or write transaction is performed (see Figure 26).

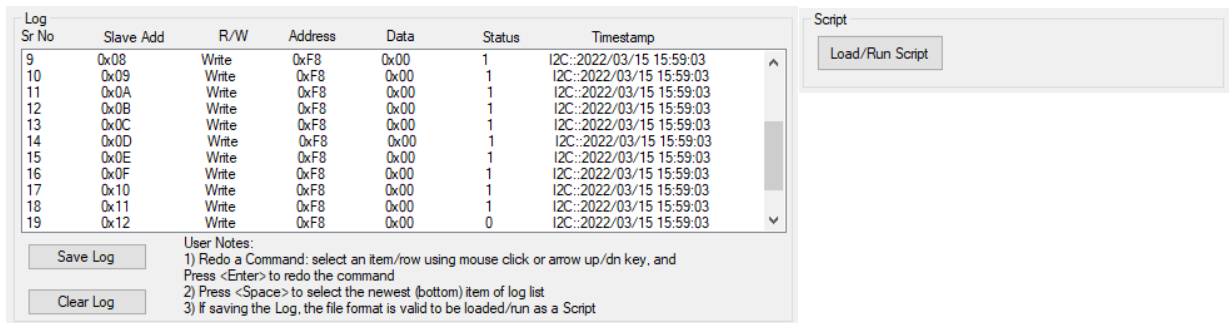

Figure 26. I²C Log

To redo a given command select the row using a mouse click or using the arrow up/down keys and press **<Enter>**. Press **<Space>** to jump to the most recently logged item (bottom of the list).

3.5.7.1 Save Log

All the transactions in the log are saved into a specifically formatted text file using the **Save Log** option.

3.5.7.2 Clear Log

The transactions in the log can be cleared by using the **Clear Log** option.

3.5.7.3 Load/Run Script

A saved log file (see [Save Log](#)) can be loaded and executed as a script. The I²C transactions execute in sequential order as defined by the log file. Both I²C read and write is supported. **Note:** If the log file has an incorrect slave address or line format, the script routine is terminated and a message box notifies the user of the error encountered (see [Figure 27](#)).

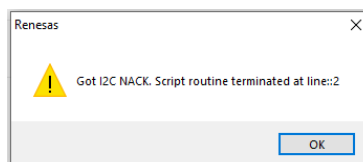

Figure 27. Script Termination

3.6 General Tab

The General tab contains ancillary controls to help user interaction with the IC, dongle, and GUI (see Figure 28). The following sections describe the available controls.

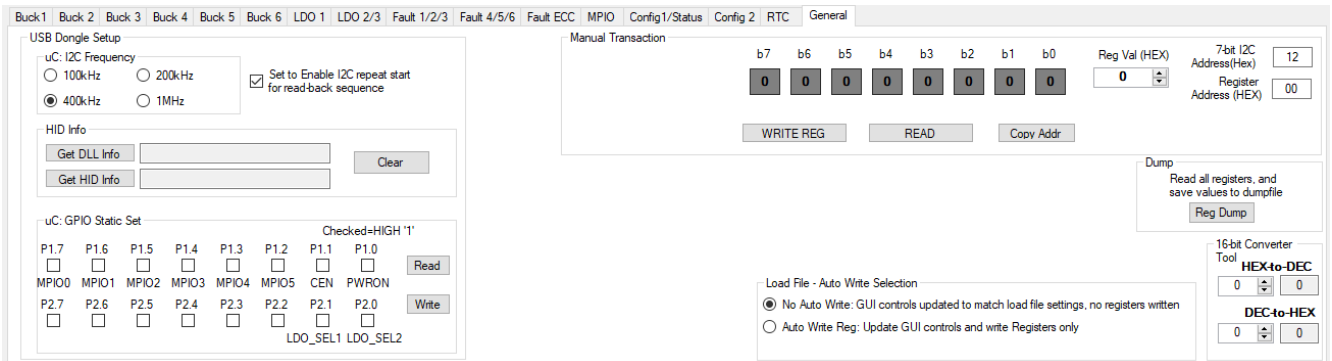

Figure 28. General Tab

3.6.1 Manual Transaction

The General tab includes an independent manual transaction section that is used to perform a user-configured, standard I²C transaction, see Figure 29. This feature operates independently from the main (IC specific) GUI tabs and controls. Register data read and written through this mechanism is not automatically reflected in the main GUI controls. Specific GUI register control(s) can subsequently be updated (synchronized) by a register specific read or read-all operation on the main GUI, see Read All.

The manual transaction is a useful debug tool and can be used to communicate with the Renesas device under test, and/or other I²C compliant devices on the bus.



Figure 29. Manual Transaction

3.6.1.1 7-Bit I²C Address Text Box

The slave address of the target IC is entered into the **7-bit I²C Address** box. Valid entries are hexadecimal 0 to 7F, other values or characters are not accepted.

3.6.1.2 Register Address Text Box

The 8-bit register address is entered into the **Register Address** box. Valid entries are hexadecimal 0 to FF, other values or characters are not accepted.

3.6.1.3 Reg Val (HEX) Numeric Text Box

The 8-bit register value is entered into **Register Val** box. Valid entries are hexadecimal 0 to FF, other values or characters are not accepted. The **Reg Val (HEX)** box works bi-directionally with the bit buttons.

3.6.1.3.1 Bit Buttons

The **Bit** buttons beneath each b7~b0 labels show 0 or 1 and gray or green, respectively, to visually represent the value shown in the **Reg Val (HEX)** box. The user may also click the bit buttons to toggle the bit values, and the updated total register value is updated accordingly in the **Reg Val (HEX)** box.

3.6.1.4 Copy Addr Button

The **Copy Addr** button copies the currently selected slave address from the Device Address (Main) and sets it to the **7-bit I²C Address** box.

3.6.1.5 Read Button

The **Read** button performs an I²C read transaction from the register address entered into the **Register Address** box and populates the value in the **Reg Val** box. The slave address for the transaction is used from the **7-bit I²C Address** box. A message box appears if the I²C transaction encounters NACK (see [Figure 24](#)).

3.6.1.6 Write Reg Button

The **Write Reg** button performs an I²C write transaction to the register address entered into the **Register Address** box with the value in the **Reg Val** box. The slave address for the transaction is used from the **7-bit I²C Address** box. A message box appears if the I²C transaction encounters NACK (see [Figure 24](#)).

3.6.2 USB Dongle Setup

The USB Dongle Setup section, located on the General tab, provides setup and control of the microcontroller (MCU) on the HID dongle board (see [Figure 30](#)).

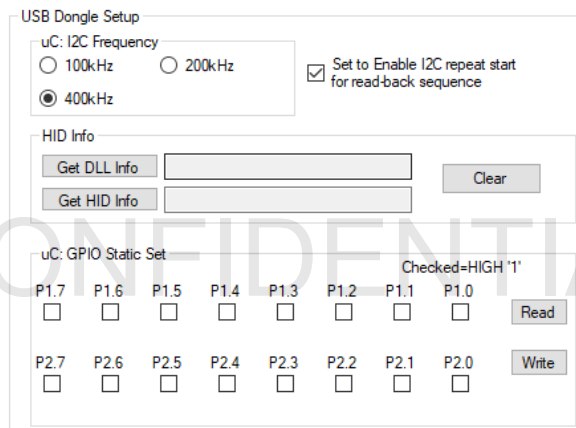

Figure 30. USB Dongle Setup

3.6.2.1 I²C Frequency Radio Button

The I²C frequency radio buttons allows changing the SCL frequency.

3.6.2.2 Enable I²C Repeat Start Check Box

The dongle supports both I²C Stop-Start and Repeated Start read transactions. Checking the box (default) enables the repeated start option.

3.6.2.3 HID Info

This is an informational section that reports the Renesas DLL and HID dongle firmware details.

3.6.2.4 GPIO Static Set

The MCU has general purpose open-collector output port pins with weak pull-up to 3.3V. These output pins are controlled manually from the GPIO Static Set GUI controls. A checked box for a pin (or pins) chooses logic HIGH. An unchecked box for a pin (or pins) chooses logic LOW. To apply the check box selections to the HID dongle click the **Write** button. The **Read** button reads back the current state of all the dongle pins and updates the GUI.

Note: More than one pin can be checked or unchecked at the same time.

Only general purpose ports P1.0 to P1.7, P2.0 and P2.1 are branched out from the dongle connector (see Figure 31).

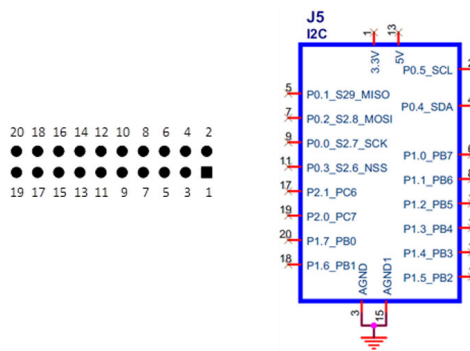

Figure 31. ISLUSBMINIZEVAL1Z HID Dongle Pin Assignments

3.6.3 16-Bit Converter Tool

This tool converts 16-bit hexadecimal and decimal numbers as shown in Figure 32. The maximum hexadecimal allowed is 0xFFFF, and the maximum decimal allowed is 65536.



Figure 32. 16-bit Converter Tool

CONFIDENTIAL

3.6.4 Register Dump

The register dump button reads back all necessary registers from the IC and creates a text file with a dump of register data. A register dump does not update the GUI controls.

The dump file format is compatible with the **File > Open** operation (see [File Menu](#)), therefore, it can be (re)loaded to the GUI.

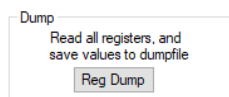

Figure 33. Register Dump

3.6.5 Auto Write Selection

The GUI provides a selection for how to behave when a text load file is opened and settings are loaded to the GUI. The default operation only updates the GUI selections. The user must manually click each register write button, or click **Write All** after **File > Open**, to write all the registers in the IC.

An optional GUI setting offloads the user task of writing all registers. When selected, it automatically attempts a **Write All** register operation after the text load file has been read and the GUI settings updated.

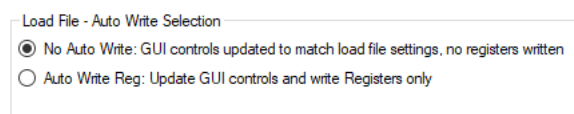

Figure 34. Auto-write Behavior Selection

4. Software Uninstall Process

The evaluation software can be uninstalled in a few simple steps. Navigate to the program in the Windows Start menu under the Renesas folder. Right-click on the program name and choose **Uninstall**. This opens the Windows Control Panel **Programs and Features**, where the program can be selected and uninstalled.

5. Troubleshooting Tips

The following are common troubleshooting tips for users experiencing issues while installing or using the evaluation software.

- Issues with installing or running program:
 - Try running installer and/or opening the program with administrative rights (right-click and Run As Administrator).
 - If Run As Administrator does not resolve the issue, the issue could be related to a third-party restriction such as corporate security policy or anti-virus. Contact your local IT administrator for further help.
 - Ensure the proper .NET frameworks are installed on the machine. Both .NET common runtime language (CLR) 4 and CLR 2 are required. This assembly targets .NET 4.5. .NET framework 4.5 or greater is required, which inherently runs CLR 4. Additionally, newer OS (such as Windows 10) also need to have .NET framework 3.5 enabled.
- Evaluation software text is enlarged, cut-off, or missing:
 - The evaluation software does not support non-native scaling or dynamic resizing, therefore, verify that the PC display settings are set to a 100% scale factor. This setting is in the Display Settings of a Windows PC.
 - The evaluation software is sized optimally for display resolution of 1366×768 or higher.
- Evaluation software cannot connect to the Renesas HID dongle:
 - The USB cable is not connected to the PC USB port and/or Renesas HID dongle. Connect the cable to both the PC USB port and Renesas HID dongle.
 - The USB cable is damaged. Replace the USB cable.
 - Bad USB port. Ensure the USB device is recognized by the machine. This can be checked in the Windows Device Manager. The connection/cable and port are good if different audible tones can be heard from PC when plugging the cable in and out.
 - Another Renesas HID dongle is already connected to the machine.
- Issues with updating to newer version of the evaluation software:
 - Uninstall the existing software as described in the [Software Uninstall Process](#); next, reinstall the newer version.
- Evaluation software text looks different than the images in the manual:
 - The evaluation software was developed in Windows 10 with a default system font for the English (United States) language setting. Other regions might use a different default system font for English, which affects the appearance of the evaluation software but not its operation.
- HID communication error message:
 - The GUI can report various HID USB communication errors using a message box (see [Figure 35](#)). The message box reports an error code number. Check all physical connections, restart the IC, and exit/reopen the GUI.
 - If the issue persists, contact Renesas to help diagnose the problem.

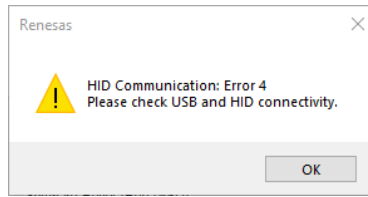

Figure 35. HID Communication Error Example

6. Revision History

Revision	Date	Description
1.01	Aug 29, 2022	Updated System Requirements section. Added another bullet in the Troubleshooting Tips section.
1.00	Jun 30, 2022	Initial release.

CONFIDENTIAL

IMPORTANT NOTICE AND DISCLAIMER

RENESAS ELECTRONICS CORPORATION AND ITS SUBSIDIARIES (“RENESAS”) PROVIDES TECHNICAL SPECIFICATIONS AND RELIABILITY DATA (INCLUDING DATASHEETS), DESIGN RESOURCES (INCLUDING REFERENCE DESIGNS), APPLICATION OR OTHER DESIGN ADVICE, WEB TOOLS, SAFETY INFORMATION, AND OTHER RESOURCES “AS IS” AND WITH ALL FAULTS, AND DISCLAIMS ALL WARRANTIES, EXPRESS OR IMPLIED, INCLUDING, WITHOUT LIMITATION, ANY IMPLIED WARRANTIES OF MERCHANTABILITY, FITNESS FOR A PARTICULAR PURPOSE, OR NON-INFRINGEMENT OF THIRD PARTY INTELLECTUAL PROPERTY RIGHTS.

These resources are intended for developers skilled in the art designing with Renesas products. You are solely responsible for (1) selecting the appropriate products for your application, (2) designing, validating, and testing your application, and (3) ensuring your application meets applicable standards, and any other safety, security, or other requirements. These resources are subject to change without notice. Renesas grants you permission to use these resources only for development of an application that uses Renesas products. Other reproduction or use of these resources is strictly prohibited. No license is granted to any other Renesas intellectual property or to any third party intellectual property. Renesas disclaims responsibility for, and you will fully indemnify Renesas and its representatives against, any claims, damages, costs, losses, or liabilities arising out of your use of these resources. Renesas' products are provided only subject to Renesas' Terms and Conditions of Sale or other applicable terms agreed to in writing. No use of any Renesas resources expands or otherwise alters any applicable warranties or warranty disclaimers for these products.

(Rev.1.0 Mar 2020)

Corporate Headquarters

TOYOSU FORESIA, 3-2-24 Toyosu,
Koto-ku, Tokyo 135-0061, Japan
www.renesas.com

Contact Information

For further information on a product, technology, the most up-to-date version of a document, or your nearest sales office, please visit:
www.renesas.com/contact/

Trademarks

Renesas and the Renesas logo are trademarks of Renesas Electronics Corporation. All trademarks and registered trademarks are the property of their respective owners.