

To our customers,

Old Company Name in Catalogs and Other Documents

On April 1st, 2010, NEC Electronics Corporation merged with Renesas Technology Corporation, and Renesas Electronics Corporation took over all the business of both companies. Therefore, although the old company name remains in this document, it is a valid Renesas Electronics document. We appreciate your understanding.

Renesas Electronics website: <http://www.renesas.com>

April 1st, 2010
Renesas Electronics Corporation

Issued by: Renesas Electronics Corporation (<http://www.renesas.com>)

Send any inquiries to <http://www.renesas.com/inquiry>.

Notice

1. Descriptions of circuits, software and other related information in this document are provided only to illustrate the operation of semiconductor products and application examples. You are fully responsible for the incorporation of these circuits, software, and information in the design of your equipment. Renesas Electronics assumes no responsibility for any losses incurred by you or third parties arising from the use of these circuits, software, or information.
2. Renesas Electronics has used reasonable care in preparing the information included in this document, but Renesas Electronics does not warrant that such information is error free. Renesas Electronics assumes no liability whatsoever for any damages incurred by you resulting from errors in or omissions from the information included herein.
3. Renesas Electronics does not assume any liability for infringement of patents, copyrights, or other intellectual property rights of third parties by or arising from the use of Renesas Electronics products or technical information described in this document. No license, express, implied or otherwise, is granted hereby under any patents, copyrights or other intellectual property rights of Renesas Electronics or others.
4. You should not alter, modify, copy, or otherwise misappropriate any Renesas Electronics product, whether in whole or in part. Renesas Electronics assumes no responsibility for any losses incurred by you or third parties arising from such alteration, modification, copy or otherwise misappropriation of Renesas Electronics product.
5. Renesas Electronics products are classified according to the following two quality grades: "Standard" and "High Quality". The recommended applications for each Renesas Electronics product depends on the product's quality grade, as indicated below.
"Standard": Computers; office equipment; communications equipment; test and measurement equipment; audio and visual equipment; home electronic appliances; machine tools; personal electronic equipment; and industrial robots etc.
"High Quality": Transportation equipment (automobiles, trains, ships, etc.); traffic control systems; anti-disaster systems; anti-crime systems; and safety equipment etc.

Renesas Electronics products are neither intended nor authorized for use in products or systems that may pose a direct threat to human life or bodily injury (artificial life support devices or systems, surgical implantations etc.), or may cause serious property damages (nuclear reactor control systems, military equipment etc.). You must check the quality grade of each Renesas Electronics product before using it in a particular application. You may not use any Renesas Electronics product for any application for which it is not intended. Renesas Electronics shall not be in any way liable for any damages or losses incurred by you or third parties arising from the use of any Renesas Electronics product for which the product is not intended by Renesas Electronics.
6. You should use the Renesas Electronics products described in this document within the range specified by Renesas Electronics, especially with respect to the maximum rating, operating supply voltage range, movement power voltage range, heat radiation characteristics, installation and other product characteristics. Renesas Electronics shall have no liability for malfunctions or damages arising out of the use of Renesas Electronics products beyond such specified ranges.
7. Although Renesas Electronics endeavors to improve the quality and reliability of its products, semiconductor products have specific characteristics such as the occurrence of failure at a certain rate and malfunctions under certain use conditions. Further, Renesas Electronics products are not subject to radiation resistance design. Please be sure to implement safety measures to guard them against the possibility of physical injury, and injury or damage caused by fire in the event of the failure of a Renesas Electronics product, such as safety design for hardware and software including but not limited to redundancy, fire control and malfunction prevention, appropriate treatment for aging degradation or any other appropriate measures. Because the evaluation of microcomputer software alone is very difficult, please evaluate the safety of the final products or systems manufactured by you.
8. Please contact a Renesas Electronics sales office for details as to environmental matters such as the environmental compatibility of each Renesas Electronics product. Please use Renesas Electronics products in compliance with all applicable laws and regulations that regulate the inclusion or use of controlled substances, including without limitation, the EU RoHS Directive. Renesas Electronics assumes no liability for damages or losses occurring as a result of your noncompliance with applicable laws and regulations.
9. Renesas Electronics products and technology may not be used for or incorporated into any products or systems whose manufacture, use, or sale is prohibited under any applicable domestic or foreign laws or regulations. You should not use Renesas Electronics products or technology described in this document for any purpose relating to military applications or use by the military, including but not limited to the development of weapons of mass destruction. When exporting the Renesas Electronics products or technology described in this document, you should comply with the applicable export control laws and regulations and follow the procedures required by such laws and regulations.
10. It is the responsibility of the buyer or distributor of Renesas Electronics products, who distributes, disposes of, or otherwise places the product with a third party, to notify such third party in advance of the contents and conditions set forth in this document, Renesas Electronics assumes no responsibility for any losses incurred by you or third parties as a result of unauthorized use of Renesas Electronics products.
11. This document may not be reproduced or duplicated in any form, in whole or in part, without prior written consent of Renesas Electronics.
12. Please contact a Renesas Electronics sales office if you have any questions regarding the information contained in this document or Renesas Electronics products, or if you have any other inquiries.

(Note 1) "Renesas Electronics" as used in this document means Renesas Electronics Corporation and also includes its majority-owned subsidiaries.

(Note 2) "Renesas Electronics product(s)" means any product developed or manufactured by or for Renesas Electronics.

User's Manual**Applilet[®] EZ PL****For Ver. 3.6 or Later**

Target Devices**78K0S/KA1+****78K0S/KB1+****78K0S/KU1+****78K0S/KY1+****78K0/KB2****78K0/KC2****78K0/KD2****78K0/KE2****78K0/KF2****78K0/KC2-L****78K0R/KE3-L**

[MEMO]

Applilet is a registered trademark of NEC Electronics Corporation.

Windows is either a registered trademark or a trademark of Microsoft Corporation in the United States and/or other countries.

Pentium is a trademark of Intel Corporation.

• **The information in this document is current as of September, 2008. The information is subject to change without notice. For actual design-in, refer to the latest publications of NEC Electronics data sheets or data books, etc., for the most up-to-date specifications of NEC Electronics products. Not all products and/or types are available in every country. Please check with an NEC Electronics sales representative for availability and additional information.**

• No part of this document may be copied or reproduced in any form or by any means without the prior written consent of NEC Electronics. NEC Electronics assumes no responsibility for any errors that may appear in this document.

• NEC Electronics does not assume any liability for infringement of patents, copyrights or other intellectual property rights of third parties by or arising from the use of NEC Electronics products listed in this document or any other liability arising from the use of such products. No license, express, implied or otherwise, is granted under any patents, copyrights or other intellectual property rights of NEC Electronics or others.

• Descriptions of circuits, software and other related information in this document are provided for illustrative purposes in semiconductor product operation and application examples. The incorporation of these circuits, software and information in the design of a customer's equipment shall be done under the full responsibility of the customer. NEC Electronics assumes no responsibility for any losses incurred by customers or third parties arising from the use of these circuits, software and information.

• While NEC Electronics endeavors to enhance the quality, reliability and safety of NEC Electronics products, customers agree and acknowledge that the possibility of defects thereof cannot be eliminated entirely. To minimize risks of damage to property or injury (including death) to persons arising from defects in NEC Electronics products, customers must incorporate sufficient safety measures in their design, such as redundancy, fire-containment and anti-failure features.

• NEC Electronics products are classified into the following three quality grades: "Standard", "Special" and "Specific".

The "Specific" quality grade applies only to NEC Electronics products developed based on a customer-designated "quality assurance program" for a specific application. The recommended applications of an NEC Electronics product depend on its quality grade, as indicated below. Customers must check the quality grade of each NEC Electronics product before using it in a particular application.

"Standard": Computers, office equipment, communications equipment, test and measurement equipment, audio and visual equipment, home electronic appliances, machine tools, personal electronic equipment and industrial robots.

"Special": Transportation equipment (automobiles, trains, ships, etc.), traffic control systems, anti-disaster systems, anti-crime systems, safety equipment and medical equipment (not specifically designed for life support).

"Specific": Aircraft, aerospace equipment, submersible repeaters, nuclear reactor control systems, life support systems and medical equipment for life support, etc.

The quality grade of NEC Electronics products is "Standard" unless otherwise expressly specified in NEC Electronics data sheets or data books, etc. If customers wish to use NEC Electronics products in applications not intended by NEC Electronics, they must contact an NEC Electronics sales representative in advance to determine NEC Electronics' willingness to support a given application.

(Note)

(1) "NEC Electronics" as used in this statement means NEC Electronics Corporation and also includes its majority-owned subsidiaries.

(2) "NEC Electronics products" means any product developed or manufactured by or for NEC Electronics (as defined above).

PREFACE

Readers This manual is intended for users who understand the 78K0/Kx2, 78K0S/Kx1+, 78K0R/KE3-L, and 78K0/KC2-L and want to design and develop application systems and programs by using them.

Purpose This manual is intended to help users understand how to use Applilet EZ PL and its functions, which are organized in the order below.

Structure This manual consists of the following chapters:

- Overview
- Setting up software and hardware
- Starting and ending
- Functions of Applilet EZ PL
- Window reference
- Error messages

How to Read This Manual It is assumed that the readers of this manual have general knowledge of electrical engineering, logic circuits, and microcontrollers.

To learn about the functions of Applilet EZ PL

→ Read this manual in the order of the **CONTENTS**.

To learn about the hardware functions of the 78K0/Kx2

→ See the 78K0/Kx2 product user's manual.

To learn about the hardware functions of the 78K0S/Kx1+

→ See the 78K0S/Kx1+ product user's manual.

To learn about the hardware functions of the 78K0R/KE3-L

→ See the **78K0R/Kx3-L User's Manual (U19291E)**.

To learn about the hardware functions of the 78K0/KC2-L (under development)

→ See the **78K0/Kx2-L User's Manual (U19111E)**^{Note}.

Note The product for this manual is under development. The manual will be issued after the product is released.

For information about the TK-78K0R/KE3L and TK-78K0/KC2L (under development)

→ See the user's manuals and application notes issued by [Tessera Technology Inc.](#)

Conventions

Data significance: Higher digits on the left and lower digits on the right
 Active low representation: \overline{xxx} (overscore over pin or signal name)
Note: Footnote for item marked with **Note** in the text
Caution: Information requiring particular attention
Remark: Supplementary information
 Numerical representation: Binary ... xxxx or xxxxB
 Decimal ... xxxx
 Hexadecimal ... xxxxH

Related Documents

The related documents indicated in this publication may include preliminary versions. However, preliminary versions are not marked as such.

Documents Related to Devices

Document Name	Document No.
78K0/Kx2 User's Manual	U18598E
78K0S/KA1+ User's Manual	U16898E
78K0S/KB1+ User's Manual	U17446E
78K0S/KU1+ User's Manual	U18172E
78K0S/KY1+ User's Manual	U16994E
78K0R/Kx3-L User's Manual	U19291E
78K0/Kx2-L User's Manual	U19111E

Caution The documents above are subject to change without notice. Be sure to use the latest version of each document for design and other purposes.

Documents Related to Development Software Tools

- 78K0/Kx2, 78K0/KC2-L

Document Name		Document No.
RA78K0 Ver. 3.80 User's Manual ^{Note 1}	Operation	U17199E
	Language	U17198E
	Structured Assembly Language	U17197E
RA78K0 Ver. 4.01 Operating Precautions ^{Note 1}		ZUD-CD-07-0181-E
CC78K0 Ver. 3.70 User's Manual ^{Note 2}	Operation	U17201E
	Language	U17200E
CC78K0 Ver. 4.00 Operating Precautions ^{Note 2}		ZUD-CD-07-0103-E
SM+ User's Manual	Operation	U18601E
	User Open Interface	U18212E
ID78K0-QB Ver. 2.94 User's Manual	Operation	U18330E
ID78K0-QB Ver. 3.00 User's Manual	Operation	U18492E
PM plus Ver. 5.20 ^{Note 3} User's Manual		U16569E
PM+ Ver. 6.30 ^{Note 4} User's Manual		U18416E

- Notes**
1. This document is installed into the PC together with the tool when installing RA78K0 Ver. 4.01. For descriptions not included in "RA78K0 Ver. 4.01 Operating Precautions", see the user's manual of RA78K0 Ver. 3.80.
 2. This document is installed into the PC together with the tool when installing CC78K0 Ver. 4.00. For descriptions not included in "CC78K0 Ver. 4.00 Operating Precautions", see the user's manual of CC78K0 Ver. 3.70.
 3. PM plus Ver. 5.20 is the integrated development environment included with RA78K0 Ver. 3.80.
 4. PM+ Ver. 6.30 is the integrated development environment included with RA78K0 Ver. 4.01. Software tool (assembler, C compiler, debugger, and simulator) products of different versions can be managed.

Caution The documents above are subject to change without notice. Be sure to use the latest version of each document for design and other purposes.

• 78K0S/Kx1+

Document Name		Document No.
RA78K0S Ver. 1.40 or Later User's Manual	Operation	U16656E
RA78K0S Ver. 1.30 or Later User's Manual	Language	U14877E
RA78K0S ST78K0S Ver. 1.00 or Later User's Manual	Structured Assembly Language	U11623E
RA78K0S Ver. 2.00 User's Manual	Operation	U17391E
	Language	U17390E
	Structured Assembly Language	U17389E
CC78K0S Ver. 1.50 or Later User's Manual	Operation	U16654E
CC78K0S Ver. 1.30 or Later User's Manual	Language	U14872E
CC78K0S Ver. 2.00 User's Manual	Operation	U17416E
	Language	U17415E
SM+ User's Manual	Operation	U18601E
	User Open Interface	U18212E
ID78K0S-QB Ver. 2.90 User's Manual	Operation	U18247E
ID78K0S-QB Ver. 3.00 User's Manual	Operation	U18493E
PM plus Ver. 5.20 ^{Note 1} User's Manual		U16569E
PM+ Ver. 6.30 ^{Note 2} User's Manual		U18416E

Notes 1. PM plus Ver. 5.20 is the integrated development environment included with RA78K0S Ver. 1.40.

2. PM+ Ver. 6.30 is the integrated development environment included with RA78K0 Ver. 2.00. Software tool (assembler, C compiler, debugger, and simulator) products of different versions can be managed.

• 78K0R/KE3-L

Document Name		Document No.
RA78K0R Ver. 1.20 User's Manual	Operation	U18547E
	Language	U18546E
CC78K0R Ver. 2.00 User's Manual	Operation	U18549E
	Language	U18548E
SM+ User's Manual	Operation	U18601E
	User Open Interface	U18212E
PM+ Ver. 6.30 User's Manual		U18416E
ID78K0R-QB Ver. 3.20 User's Manual	Operation	U17839E

Caution The documents above are subject to change without notice. Be sure to use the latest version of each document for design and other purposes.

CONTENTS

CHAPTER 1 OVERVIEW	13
1.1 Overview.....	13
1.2 Features.....	13
1.3 Program Development Overview	14
1.4 System Components.....	15
1.5 Operating Environment.....	15
CHAPTER 2 SETTING UP THE SOFTWARE	18
2.1 Installing Applilet EZ PL.....	18
2.1.1 Installing Applilet EZ PL.....	18
2.1.2 Applilet EZ PL folder structure	20
2.1.3 Windows [Start] menu and shortcut icon	21
2.2 Uninstalling Applilet EZ PL.....	21
CHAPTER 3 SETTING UP THE HARDWARE	22
3.1 Using a Self-Built Board or the TB Board.....	22
3.1.1 Installing software.....	22
3.1.2 Setting up Applilet EZ PL.....	22
3.1.3 Connecting the hardware when writing to flash memory	22
3.2 Using a Supported Evaluation Board.....	23
3.2.1 Installing software.....	23
3.2.2 Setting up Applilet EZ PL.....	26
3.2.3 Setting up the hardware when writing to flash memory	28
CHAPTER 4 STARTING AND ENDING	29
4.1 Starting Applilet EZ PL.....	29
4.2 Closing Applilet EZ PL	29
CHAPTER 5 FUNCTIONS OF Applilet EZ PL	30
5.1 Basic Functions of Applilet EZ PL	30
5.2 Operation Procedure	31
5.2.1 Selecting the target CPU	31
5.2.2 Editing panels	32
5.2.3 Checking after editing the panels	33
5.2.4 Simulation.....	33
5.2.5 Automatically generating object code	35
5.2.6 Writing to the 78K0/Kx2, 78K0S/Kx1+, 78K0R/KE3-L, or 78K0/KC2-L (flash writing)	35
5.2.7 Generating a PM+ project file	36
CHAPTER 6 WINDOW REFERENCE	37
6.1 Overview of Windows and Dialog Boxes.....	37
6.2 Description of Each Window and Dialog Box	38
Main window	39
Property Settings dialog box	76

Port Setting dialog box	120
Target CPU Settings dialog box	122
Watchdog Timer Setting dialog box	124
UART0 Settings dialog box	125
UART1 Settings dialog box	127
UART6 Settings dialog box	129
Flash Memory Programmer Settings dialog box	131
Saved Data Folder dialog box	133
CHAPTER 7 ERROR MESSAGES	135
7.1 When Editing a Panel	135
7.2 When Compiling or Writing to Flash Memory	135
APPENDIX A AUTOMATICALLY GENERATED FILES (FOR 78K0/Kx2 AND 78K0R/KE3-L)	139
A.1 File Structure	139
A.2 Interface.....	142
A.2.1 Digital input.....	144
A.2.2 Digital output	144
A.2.3 Analog input	145
A.2.4 UART6 input	145
A.2.5 UART6 output.....	146
A.2.6 UART0 input	146
A.2.7 UART0 output.....	147
A.2.8 Simple PWM output.....	147
A.2.9 PWM output.....	148
A.2.10 Stepping-motor output.....	148
A.2.11 Web input	149
A.2.12 Buzzer	149
A.2.13 LCD output	150
A.2.14 7-segment LED output	150
A.2.15 Logic.....	151
A.2.16 Comparator	151
A.2.17 Flip-flops.....	152
A.2.18 Counter	153
A.2.19 Timer	154
A.2.20 Delay	155
A.2.21 Clock	155
A.2.22 Logic IC	156
APPENDIX B AUTOMATICALLY GENERATED FILES (FOR 78K0S/Kx1+)	161
B.1 File Structure	161
APPENDIX C EXAMPLE OF THE 7-SEGMENT LED CONNECTION CIRCUIT IN THE 78K0/KE2 AND 78K0/KF2	162
APPENDIX D INDEX	163

LIST OF FIGURES

Figure No.	Title, Page
Figure 1-1.	Program Development Overview..... 14
Figure 1-2.	System Components..... 15
Figure 2-1.	Applilet EZ PL Folder Structure 20
Figure 2-2.	Windows [Start] Menu (Windows XP)..... 21
Figure 2-3.	Shortcut Icon..... 21
Figure 4-1.	Main Window Displayed When Applilet EZ PL Starts 29
Figure 5-1.	Example of Panels on the GUI 30
Figure 5-2.	Basic I/O Device Connections..... 30
Figure 5-3.	Target CPU Settings Dialog Box..... 31
Figure 5-4.	GUI Used for Editing Panels..... 32
Figure 5-5.	Operation up to Automatically Generating Object Code and Writing to the Flash Memory 36
Figure 6-1.	Main Window..... 39
Figure 6-2.	Simulation Area..... 41
Figure 6-3.	Confirmation Message Displayed if a Panel Exists at the Desired Location..... 64
Figure 6-4.	Example of the Displayed Correspondence of Jumpers..... 66
Figure 6-5.	Example of the Execution Status Displayed During Compilation or Writing to the Flash Memory..... 68
Figure 6-6.	Status Bar Example 75
Figure 6-7.	Example of the Property Settings Dialog Box (for the [Push Button] Panel)..... 76
Figure 6-8.	Property Settings Dialog Box (for the [Digital Input] Panel) 81
Figure 6-9.	Property Settings Dialog Box (for the [Analog Input] Panel) 82
Figure 6-10.	Property Settings Dialog Box (for the [UART6 Input] Panel)..... 84
Figure 6-11.	Property Settings Dialog Box (for the [UART0 Input] Panel)..... 85
Figure 6-12.	Property Settings Dialog Box (for the [UART1 Input] Panel)..... 86
Figure 6-13.	Property Settings Dialog Box (for the [LVI] Panel)..... 87
Figure 6-14.	Property Settings Dialog Box (for the [Push Button] Panel)..... 88
Figure 6-15.	Property Settings Dialog Box (for the [DIP Switch] Panel)..... 89
Figure 6-16.	Property Settings Dialog Box (for the [Analog Input (Illuminance)] Panel) 90
Figure 6-17.	Property Settings Dialog Box (for the [Digital Output] Panel) 91
Figure 6-18.	Property Settings Dialog Box (for the [Simple PWM] Panel) 92
Figure 6-19.	Property Settings Dialog Box (for the [PWM Output] Panel)..... 93
Figure 6-20.	Property Settings Dialog Box (for the [UART6 Output] Panel)..... 94
Figure 6-21.	Property Settings Dialog Box (for the [UART0 Output] Panel)..... 95
Figure 6-22.	Property Settings Dialog Box (for the [UART1 Output] Panel)..... 96
Figure 6-23.	Property Settings Dialog Box (for the [Step Motor] Panel) 97
Figure 6-24.	Property Settings Dialog Box (for the [Musical-Scale Output] Panel) 100
Figure 6-25.	Property Settings Dialog Box (for the [Buzzer] Panel) 101
Figure 6-26.	Property Settings Dialog Box (for the [7-Segment Display] Panel) 102
Figure 6-27.	Property Settings Dialog Box (for the [Jumper] Panel) 104
Figure 6-28.	Property Settings Dialog Box (for the [Comparator] Panel) 105
Figure 6-29.	Property Settings Dialog Box (for the [UART6 Jumper Output] Panel) 106
Figure 6-30.	Property Settings Dialog Box (for the [UART0 Jumper Output] Panel) 107
Figure 6-31.	Property Settings Dialog Box (for the [7-Segment LED Jumper (Digit Type)] Panel)..... 108
Figure 6-32.	Property Settings Dialog Box (for the [7-Segment LED Jumper (Segment Type)] Panel)..... 109

Figure 6-33. Property Settings Dialog Box (for the [7-Segment LED Jumper (Bit Type)] Panel).....	110
Figure 6-34. Property Settings Dialog Box (for the [Flip-Flop] Panel).....	111
Figure 6-35. Property Settings Dialog Box (for the [Counter] Panel).....	112
Figure 6-36. Property Settings Dialog Box (for the [Binary Counter] Panel).....	113
Figure 6-37. Property Settings Dialog Box (for the [Timer] Panel).....	114
Figure 6-38. Property Settings Dialog Box (for the [Delay] Panel).....	115
Figure 6-39. Property Settings Dialog Box (for the [Clock] Panel).....	116
Figure 6-40. Property Settings Dialog Box (for the [Stepping Motor] Panel).....	117
Figure 6-41. Property Settings Dialog Box (for the [Reset] Panel).....	119
Figure 6-42. Port Setting Dialog Box.....	120
Figure 6-43. Target CPU Settings Dialog Box.....	122
Figure 6-44. Watchdog Timer Setting Dialog Box.....	124
Figure 6-45. UART0 Settings Dialog Box.....	125
Figure 6-46. UART1 Settings Dialog Box.....	127
Figure 6-47. UART6 Settings Dialog Box.....	129
Figure 6-48. Flash Memory Programmer Settings Dialog Box (for a Device).....	131
Figure 6-49. Flash Memory Programmer Settings Dialog Box (for an Evaluation Board).....	132
Figure 6-50. Saved Data Folder Dialog Box.....	133
Figure 7-1. Example of an Error Message Displayed When Editing a Panel.....	135
Figure 7-2. Example of an Error Message Displayed When Compiling or Writing to Flash Memory.....	135
Figure A-1. Files Generated by Applilet EZ PL (for 78K0/Kx2 and 78K0R/KE3-L).....	139
Figure B-1. Files Generated by Applilet EZ PL (for 78K0S/Kx1+).....	161
Figure C-1. Example of a 7-Segment LED Connection Circuit.....	162

LIST OF TABLES

Table No.	Title, Page
Table 6-1.	Windows and Dialog Boxes Used in Applilet EZ PL 37
Table 6-2.	Input Panels ([Common] Tab)..... 43
Table 6-3.	Input Panels ([TK-78K0R/KE3L I/Os] and [TK-78K0/KC2L I/Os] Tabs) 46
Table 6-4.	Output Panels ([Common] Tab)..... 50
Table 6-5.	Output Panels ([TK-78K0R/KE3L I/Os] and [TK-78K0/KC2L I/Os] Tabs) 53
Table 6-6.	Output Panels ([Other I/Os] Tab)..... 54
Table 6-7.	Processing Panels 55
Table 6-8.	Functions of Toolbar Buttons..... 74
Table 6-9.	Property Settings Dialog Boxes 77
Table 6-10.	Truth Values for Each Flip-Flop Operation..... 111
Table 6-11.	Truth Values for Binary Counter Operations 113
Table A-1.	Generated Program Files 140
Table A-2.	Generated Header Files 140
Table A-3.	Macros Expanded to panel.c 142

CHAPTER 1 OVERVIEW

1.1 Overview

Applilet EZ PL is a software tool that can be used to automatically generate microcontroller software by using only its GUI (graphical user interface) when installed on a host.

By using Applilet EZ PL, the basic operations of systems using a microcontroller can be learned and evaluated without knowledge of complex programming languages.

1.2 Features

- **Automatic generation of object code for the 78K0/Kx2, 78K0S/Kx1+, 78K0R/KE3-L, and 78K0/KC2-L**

Applilet EZ PL can be used to automatically generate object code (*.hex) and a source file, which can be written to the flash memory in the 78K0/Kx2, 78K0S/Kx1+, 78K0R/KE3-L, and 78K0/KC2-L, by assigning GUI panels, which represent the various functions of a microcontroller, to the input, processing, or output block area.

Therefore, software can be generated without special knowledge of programming languages supported by the 78K0/Kx2, 78K0S/Kx1+, 78K0R/KE3-L, or 78K0/KC2-L.

- **Simulation**

Applilet EZ PL can be used to easily simulate and check the operations of the target system.

The operation can be checked on the PC without the target system by using this simulation function.

- **Automatic generation of a project file for the integrated development environment**

A *.prj project file for the integrated development environment PM+, made by NEC, or a *.eww project file for the integrated development environment IAR Embedded Workbench, made by IAR Systems, is automatically generated at the same time as the object code (*.hex).

By using this project file, the source file (*.c or *.h) generated by Applilet EZ PL can be easily reedited or recompiled in the integrated development environment of each company. **[Note]**

[Note] Only a source file supported by the integrated development environment PM+, made by NEC, is generated for a low-pin-count microcontroller (78K0S/Kx1+).

- **Evaluation board**

By using Applilet EZ PL with an evaluation board, created software can be easily checked.

1.3 Program Development Overview

Applilet EZ PL can automatically generate a program by using a simple procedure.

Figure 1-1. Program Development Overview

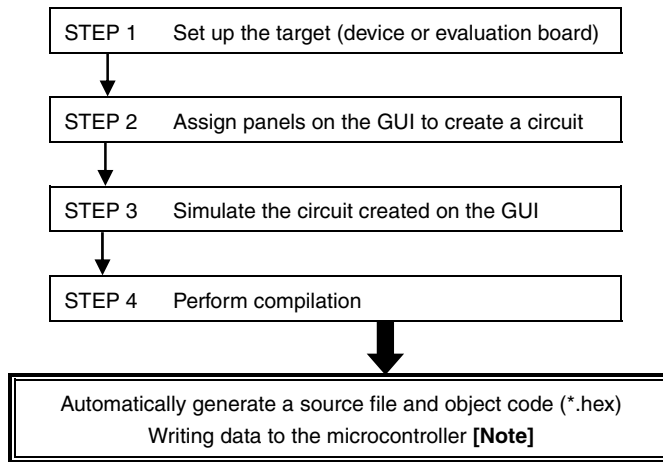

[Note] With a supported evaluation board, data can be written from Applilet EZ PL and any flash memory programmer can be added.

1.4 System Components

The system components required for using Applilet EZ PL are shown below.

Figure 1-2. System Components

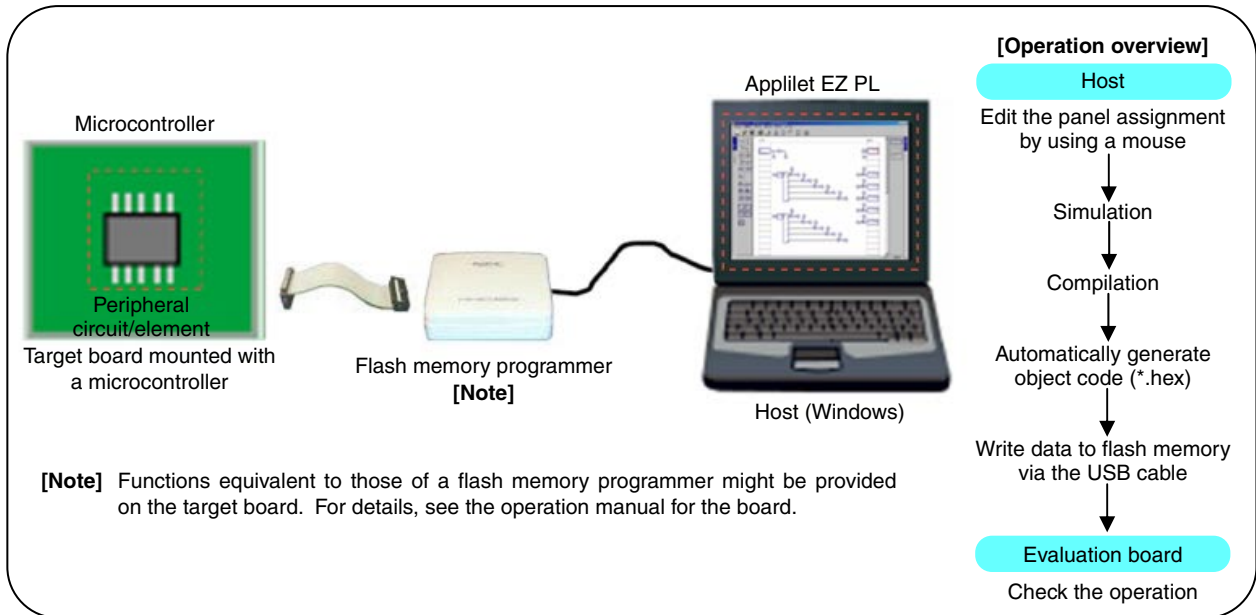

1.5 Operating Environment

The operating environment required for using Applilet EZ PL is described below.

(1) Host

OS: Windows® 2000, Windows XP, or Windows Vista **[Note]**

CPU: 300 MHz Intel Pentium™ processor or faster

Memory: At least 128 MB

[Note] Under evaluation

[Caution 1] It is recommended that the latest service pack be installed for any OS.

[Caution 2] Use a 1 GHz Pentium III processor or faster, at least 768 MB of system memory, and a high-speed graphics card when using the simulation function.

(2) Supported devices

- 78K0S/Kx1+ (78K0S/KB1+, 78K0S/KA1+, 78K0S/KY1+, 78K0S/KU1+)
- 78K0/Kx2 (78K0/KB2, 78K0/KC2, 78K0/KD2, 78K0/KE2, 78K0/KF2)
- 78K0R/KE3-L
- 78K0/KC2-L

(3) Supported evaluation boards

- A board mounted with a supported device (such as a self-built board or TB board made by NEC Electronics)
- One of the boards below
 - [Board that supports the 78K0R/KE3-L]
 - TK-78K0R/KE3L (Tessera Technology Inc.)
 - [Board that supports the 78K0/KC2-L]
 - TK-78K0/KC2L (Tessera Technology Inc.)

[Caution 1] For the latest information about evaluation boards supported by Applilet EZ PL, see the **Applilet EZ PL website below.**

URL: http://www.necel.com/micro/en/development/asia/OS_Middleware/Device_Driver_Configurator/applilet-ez-pl.html

[Caution 2] When not using a supported evaluation board, a supported evaluation board or a flash memory programmer that supports the microcontroller must be added to Applilet EZ PL. For details about how to add a programmer, see [3.1 Using a Self-Built Board or the TB Board](#).

(4) Compiler, assembler, and integrated development environment

To automatically generate software by using Applilet EZ PL, tools made by NEC Electronics or IAR Systems are required in addition to Applilet EZ PL.

Install these tools according to the development environment or CPU core **[Note 1]** to be used.

<Tools made by NEC Electronics **[Note 2]**>

- For a 78K0 core
 - Compiler: CC78K0 (Ver. 3.80 or Ver. 4.00)
 - Assembler: RA78K0 (Ver. 3.70 or Ver. 4.01) **[Note 3]**
- For a 78K0R core
 - Compiler: CC78K0R (Ver. 2.10)
 - Assembler: RA78K0R (Ver. 1.31) **[Note 3]**

<Tools made by IAR Systems>

- For all core products
 - Integrated development environment: IAR Embedded Workbench (EW78K(KS) v4.60)
 - Compiler: IAR C/C++ Compiler for NEC 78K0, 78K0S, and 78K0R (4.60)
 - Assembler: IAR Assembler for NEC 78K0, 78K0S, and 78K0R (4.60)
 - Device file: Install a device file corresponding to the product to be used.
 - Example: 78K0/Kx2: DF-78K0-Kx2-EE_XXXX **[Note 4]**
 - 78K0/Kx2-L: DF-78K0-Kx2-L-EE_XXXX **[Note 4]**
 - 78K0R/Kx3-L: DF-78K0R-Kx3-L-EE_XXXX **[Note 4]**

[Note 1] A C compiler and assembler do not have to be installed for the 78K0S/Kx1+, because Applilet EZ PL includes the components required for automatically generating software.

However, to develop a system in an integrated development environment by using the generated source file, the following tools for 78K0S products made by NEC Electronics must be installed:

Compiler: CC78K0S (V.2.01 or later)
 Assembler: RA78K0S (V.2.00 or later)
 Device file: DF789234

[Note 2] When using a software tool made by NEC Electronics, software can be automatically generated using Applilet EZ PL without installing a device file.

However, to develop a system in the integrated development environment PM+ by using the generated source file, a device file must be installed.

78K0/Kx2: DF780547

78K0/Kx2-L: DF780588

78K0R/KE3-L: DF781009

[Note 3] This includes the integrated development environment PM+.

[Note 4] “xxxx” indicates the version.

[Remark] For details about how to obtain compilers, assemblers, integrated development environments, and device files, visit the website for your region from the link below or contact your local NEC Electronics sales representative.

<http://www.necel.com/micro/en/development/index.html>

CHAPTER 2 SETTING UP THE SOFTWARE

2.1 Installing Applilet EZ PL

Install Applilet EZ PL according to the procedure below.

[Caution] When installing Applilet EZ PL V3.6 or later to a host on which an earlier version is installed, uninstall the earlier version first.

2.1.1 Installing Applilet EZ PL

- (1) Copy the installation file (*.msi) from the CD. Next, double-click this file to run the Applilet EZ PL Setup Wizard. (The screenshot below shows the wizard run on Windows XP.) Click [Next] in accordance with the displayed instructions.

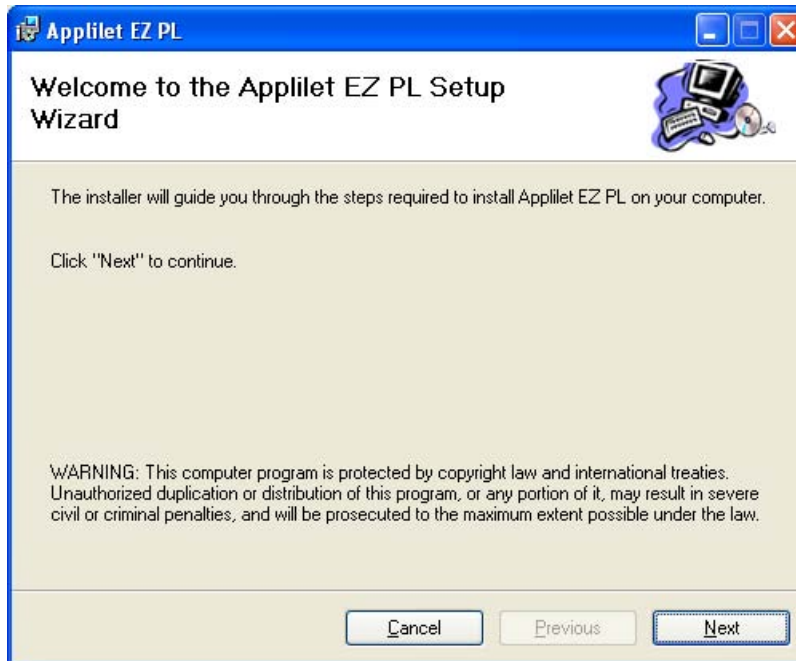

- (2) When Appilet EZ PL is successfully installed, the dialog box below indicating that the installation is complete is displayed. Click [Close] to end the installation.

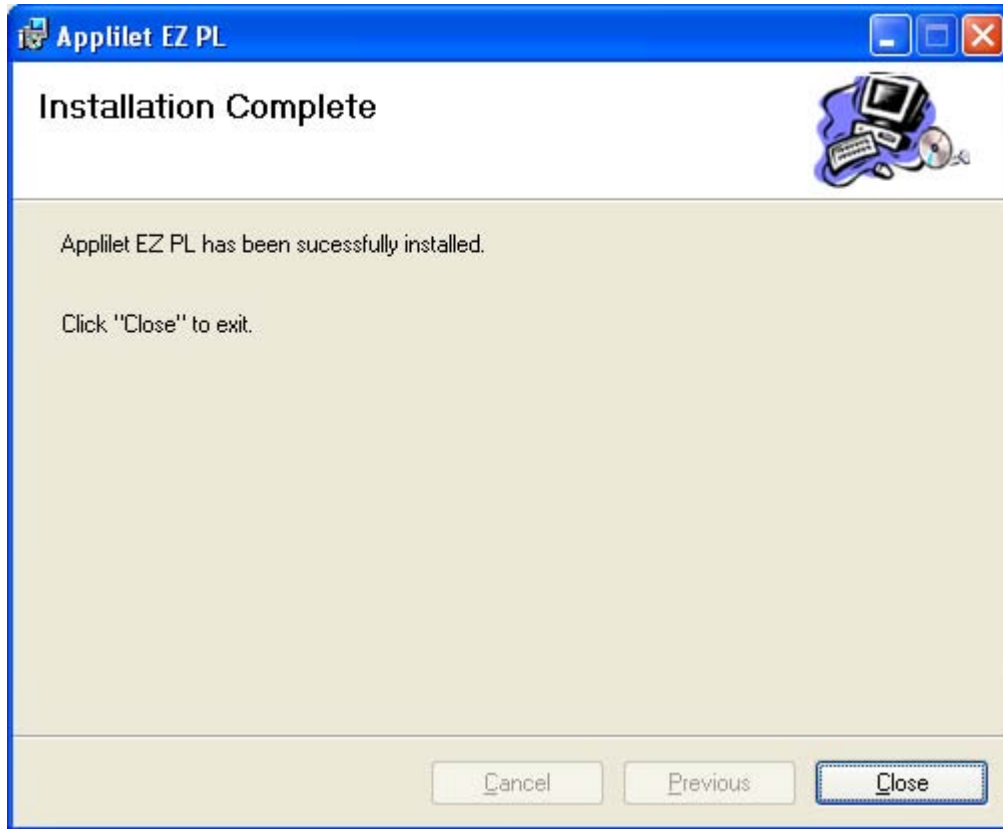

2.1.2 Applilet EZ PL folder structure

When Applilet EZ PL is successfully installed, the folders and files below are copied to the specified installation folder.

Figure 2-1. Applilet EZ PL Folder Structure

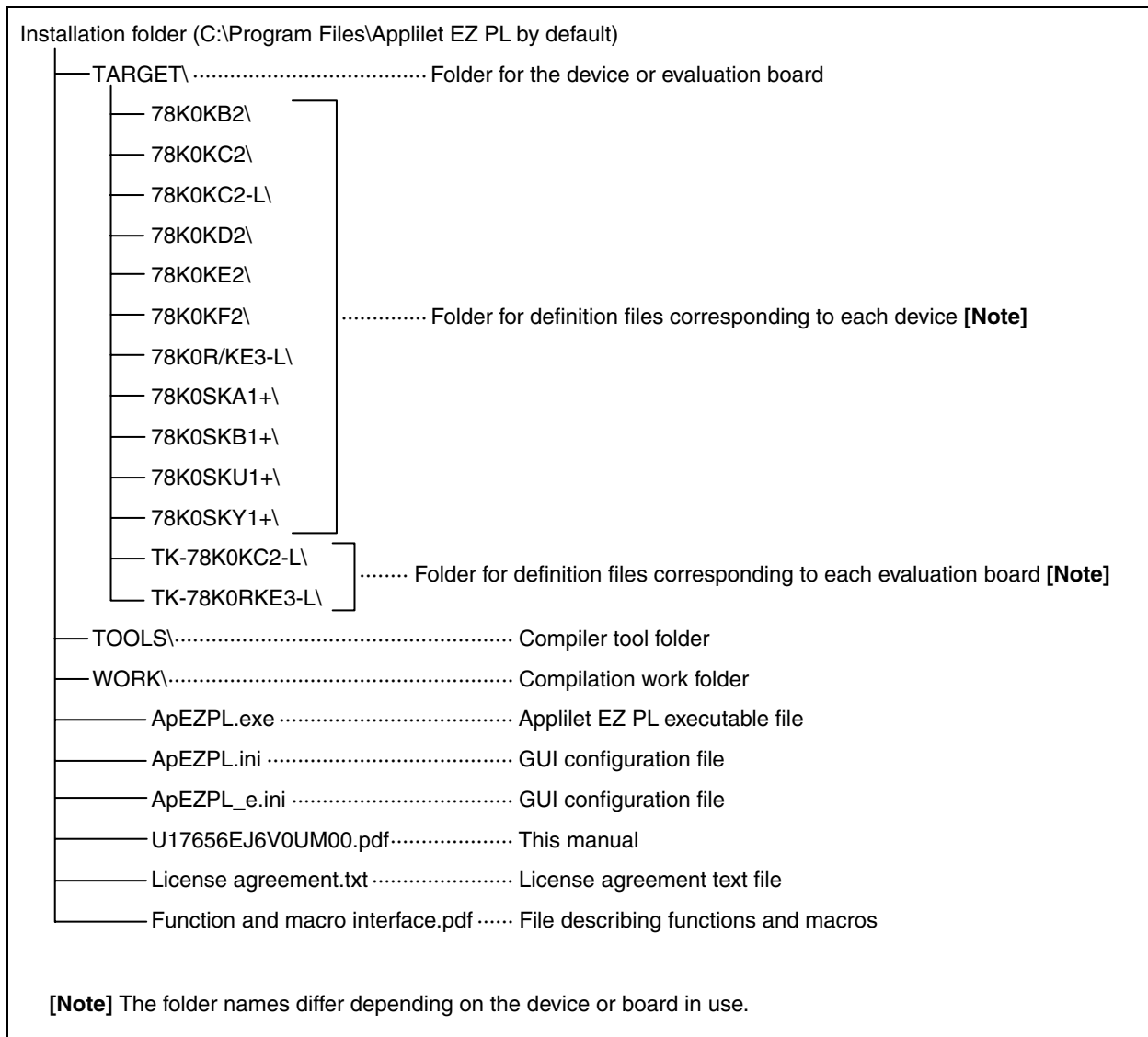

2.1.3 Windows [Start] menu and shortcut icon

The Windows [Start] menu includes the [Applilet EZ PL] menu items below.

Figure 2-2. Windows [Start] Menu (Windows XP)

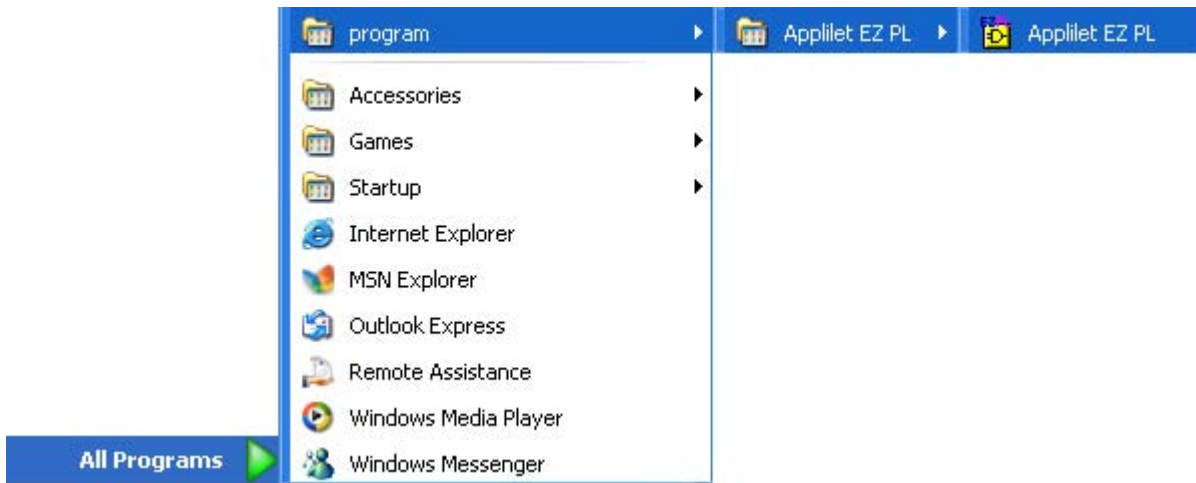

The shortcut icon below is added to the desktop.

Figure 2-3. Shortcut Icon



2.2 Uninstalling Applilet EZ PL

Uninstall Applilet EZ PL, the C compiler, and the assembler by selecting [Add or Remove Programs] (or [Add/Remove Programs] for Windows 2000) in the Control Panel.

CHAPTER 3 SETTING UP THE HARDWARE

This chapter describes how to set up the evaluation board to use for Applilet EZ PL. The setup includes the following:

- Installing software
- Setting up Applilet EZ PL
- Connecting and setting up the hardware when writing to flash memory

Perform the setup specific to your board.

→ See [3.1](#) for the setup for a self-built board or the TB board made by NEC Electronics.

→ See [3.2](#) for the setup for supported evaluation boards.

3.1 Using a Self-Built Board or the TB Board

When using a self-built board or the TB board, the setup differs depending on the write circuit to be created or the flash memory programmer to be connected. As a typical example, this section describes the setup when using MINICUBE2, made by NEC Electronics.

3.1.1 Installing software

Download and install the MINICUBE2 device driver and flash programming GUI. The MINICUBE2 device driver and flash programming GUI are included in QB-Programmer. To download QB-Programmer, follow the link below and select your region.

<http://www.necel.com/micro/en/development/index.html>

For details about the installation, see the documents provided with QB-Programmer.

[Caution] For actual write operations, a parameter file containing device-specific write information is required in addition to QB-Programmer.

3.1.2 Setting up Applilet EZ PL

To call QB-Programmer from Applilet EZ PL, QB-Programmer must first be added to the Applilet EZ PL settings.

Add QB-Programmer as follows:

- (1) Open Applilet EZ PL.
- (2) Select [Settings] in the [Main window](#) and then [Target CPU], and then select the target CPU and clock.
- (3) Click [OK] to close the dialog box.
- (4) Select [Settings] in the [Main window](#) and then [FLASH memory programmer].
- (5) Specify the full path and name of the file of the flash memory programmer to add to [Write execution file].
(With QB-Programmer Ver.2.21, the file is installed to the location below by default.)
C:\NECTools32\QBP\V2.21\bin\qbp.exe
- (6) Enter a startup parameter as required, and then click [OK].
- (7) Close Applilet EZ PL.

3.1.3 Connecting the hardware when writing to flash memory

Connect MINICUBE2 to the target device before writing data to flash memory. When writing ends, disconnect MINICUBE2 from the target device.

3.2 Using a Supported Evaluation Board

To use a supported evaluation board, the USB device driver must be installed. However, a flash memory programmer does not have to be installed separately, because it is included in Applilet EZ PL.

[Caution] If the source file generated by Applilet EZ PL has been changed and then manually recompiled or disassembled, a separate flash memory programmer is required. Use a programmer such as the simple flash memory programmer WriteEZx.

3.2.1 Installing software

When the host and USB cable are connected to the evaluation board for the first time, the Found New Hardware Wizard prompts you to install the USB driver.

Install the USB driver according to the procedure below.

- (1) When the host recognizes the evaluation board, Windows starts the wizard below (in the case of Windows XP). (The wizard might start from the page shown in (2) below, depending on your host environment.) Select [Yes, this time only] or [Yes, now and every time I connect a device], and then click [Next] to continue installing the USB driver.



- (2) On the next page, select [Install from a list or specific location (Advanced)], and then click [Next]. **[Note]**

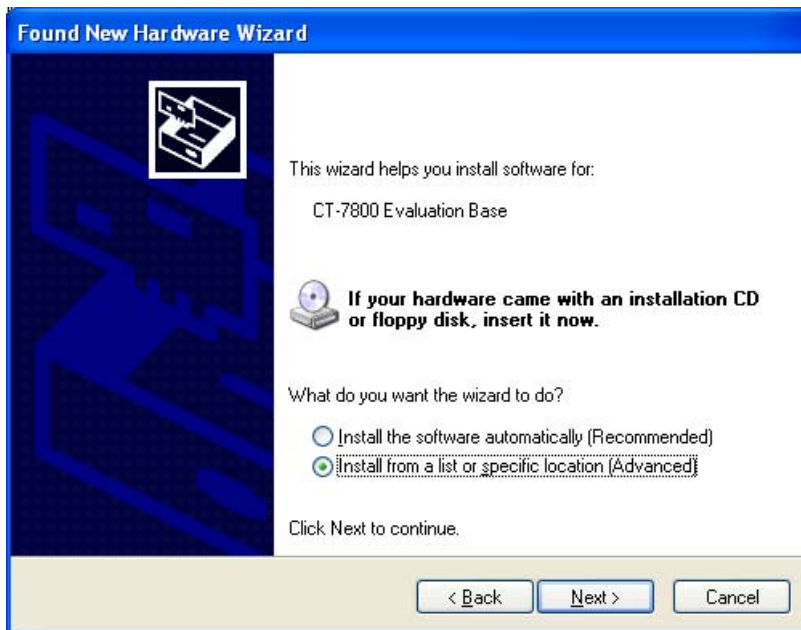

[Note] The name of the hardware displayed in the Found New Hardware Wizard differs for each product.

- (3) On the next page, specify the CD, including the driver or folder to which the downloaded files are expanded, and then click [Next].

When the driver program is detected in the specified folder, the required USB driver is installed.

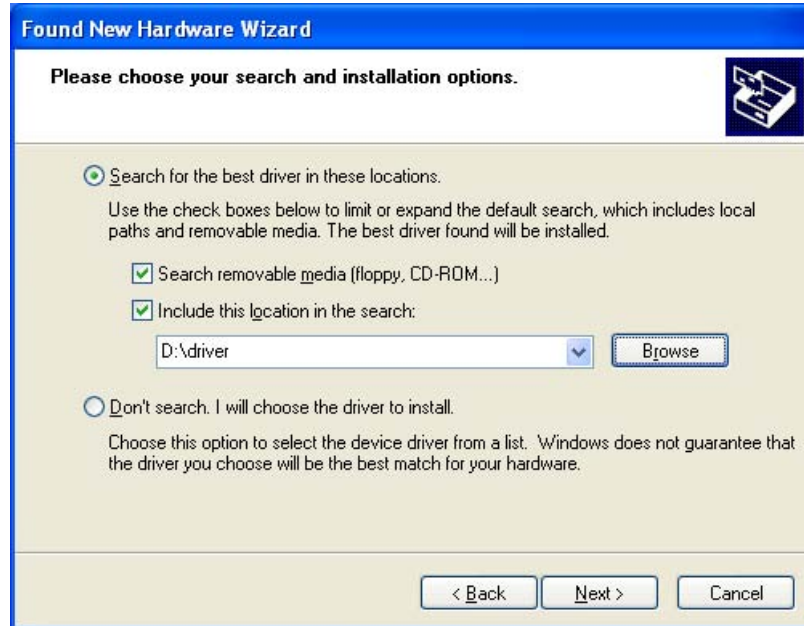

- (4) After this installation, the following page that indicates that the USB driver has been installed is displayed. Click [Finish] to close the Found New Hardware Wizard. **[Note]**



[Note] A different USB driver is displayed for each product.

- (5) For some products, the first page of the wizard might be displayed again to install the USB Serial Converter. Repeat the procedure from (1) above to install the USB Serial Converter.

[Remark] If a problem occurs during the installation, reinstall the USB driver by repeating the procedure.

[Caution] The COM port must be set up in accordance with the product.

In this case, see <2> [Setting up the COM port in Applilet EZ PL](#) and set up the COM port in Applilet EZ PL. Also see the manual for the evaluation board in use.

3.2.2 Setting up Applilet EZ PL

The compiler must be set up after installing Applilet EZ PL. The COM port must also be set up depending on the type and configuration of the target board.

3.2.2.1 Setting up the compiler

The compiler must be set up at least once after installing Applilet EZ PL. Install the environment described in **1.5 (4) Compiler, assembler, and integrated development environment** and select the installed environment (NEC or IAR) according to the procedure below.

- (1) Start Applilet EZ PL.
Select the Windows [Start] menu, [Programs], [Applilet EZ PL], and then [Applilet EZ PL].
- (2) Select the compiler:
To use the compiler made by NEC Electronics
Select the [Settings] menu, [Compiler], and then [NEC].
To use the compiler made by IAR Systems
Select the [Settings] menu, [Compiler], and then [IAR].
- (3) Close Applilet EZ PL.

[Caution] When using the low-pin-count microcontroller 78K0S/Kx1+, setting this item is invalid.

3.2.2.2 Setting up the COM port

The COM port is not required to be set up if using a supported evaluation board or using a device by specifying its name (example: 78K0/KB2). However, the COM port must be set up in the following cases:

- If multiple supported evaluation boards are connected to one PC
- If a “code=3” error occurs during writing

[Caution] A “code=3” error also is displayed when another application is using the COM port of the evaluation board. If this error occurs, make sure that no other applications are using this port.

Set up the COM port according to the procedure below.

<1> Checking the USB driver

- (1) Select the Windows [Start] menu, right-click [My Computer], and then select [Properties], or select the Windows [Start] menu, [Settings], [Control Panel], and select [System] to open the System Properties dialog box.
- (2) Select the [Hardware] tab, and then click [Device Manager].
- (3) Click the [+] displayed next to “Ports (COM & LPT)” and confirm that a new port name, which differs depending on the evaluation board, has been added as shown in the screenshot below.
To set up the port in Applilet EZ PL, specify “COMx”, which is displayed at the same location.

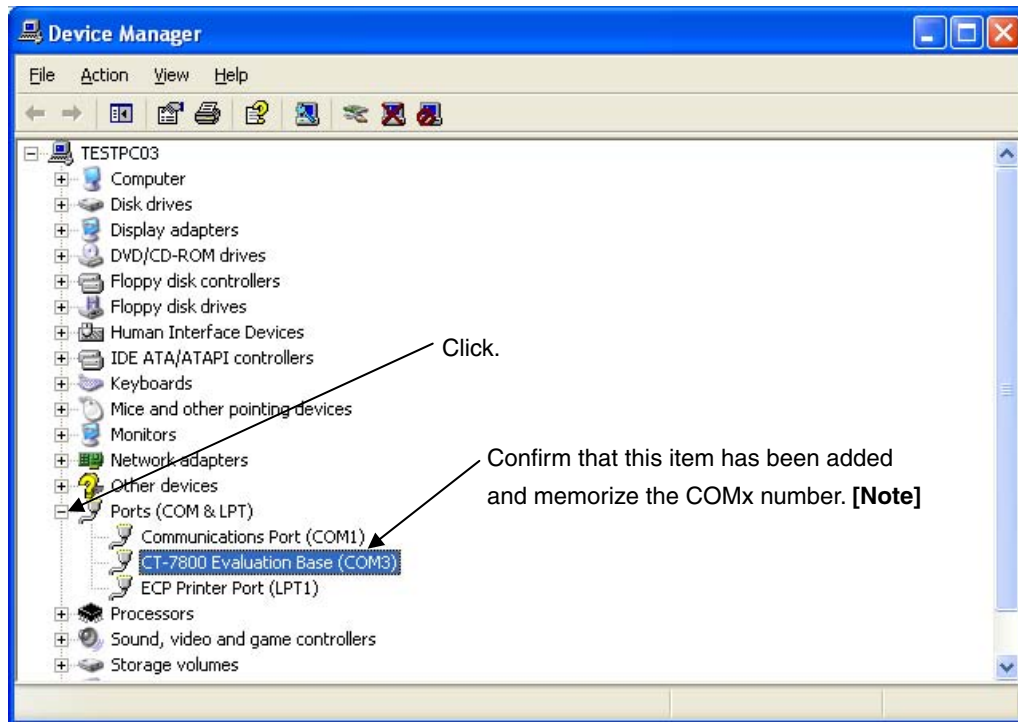

[Note] A different USB driver is displayed for each product.

The procedure for checking the USB driver is complete.

If no other port names exist or an exclamation mark is displayed, the USB driver might not be installed properly.

In this case, repeat the procedure from [3.2.1 Installing software](#).

Next, set up the COM port in Applilet EZ PL.

<2> Setting up the COM port in Applilet EZ PL

- (1) Start Applilet EZ PL by using one of the following methods.
 - Select the Windows [Start] menu, [Programs], [Applilet EZ PL], and then [Applilet EZ PL]. (See [Figure 2-2 Windows \[Start\] Menu \(Windows XP\)](#).)
 - Double click the shortcut icon. (See [Figure 2-3 Shortcut Icon](#).)
- (2) Select the [Settings] menu in the [Main window](#) and then [Target CPU]. Next, specify the target evaluation board. Set up the clock and other items, and then click [OK].
- (3) Select the [Settings] menu in the [Main window](#), and then [FLASH memory programmer] to open the [Flash Memory Programmer Settings dialog box](#).

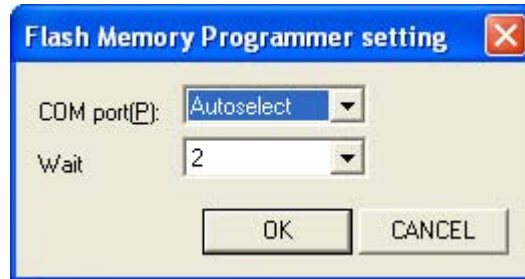

- (4) "2" is specified in the Wait field by default. Leave the setting as is if there are no problems when writing data to flash memory. If data cannot be written to flash memory or a communication error occurs, specify a greater value. (However, writing will take longer.)

The procedure for checking the USB driver and setting up the COM port in Applilet EZ PL is complete.

3.2.3 Setting up the hardware when writing to flash memory

When writing to flash memory, turn on the evaluation board, and then toggle the FLASH WRITER/UART switch for the USB port to FLASH WRITER.

To check the operation after data has been written, toggle the switch to UART, and then press the reset button.

CHAPTER 4 STARTING AND ENDING

4.1 Starting Applilet EZ PL

Start Applilet EZ PL by selecting the Windows [Start] menu, [Programs], [Applilet EZ PL], and then [Applilet EZ PL] (as shown in [Figure 2-2 Windows \[Start\] Menu \(Windows XP\)](#)), or by double-clicking the shortcut icon on the desktop (as shown in [Figure 2-3 Shortcut Icon](#)).

When Applilet EZ PL starts, the following [Main window](#) opens.

Figure 4-1. Main Window Displayed When Applilet EZ PL Starts

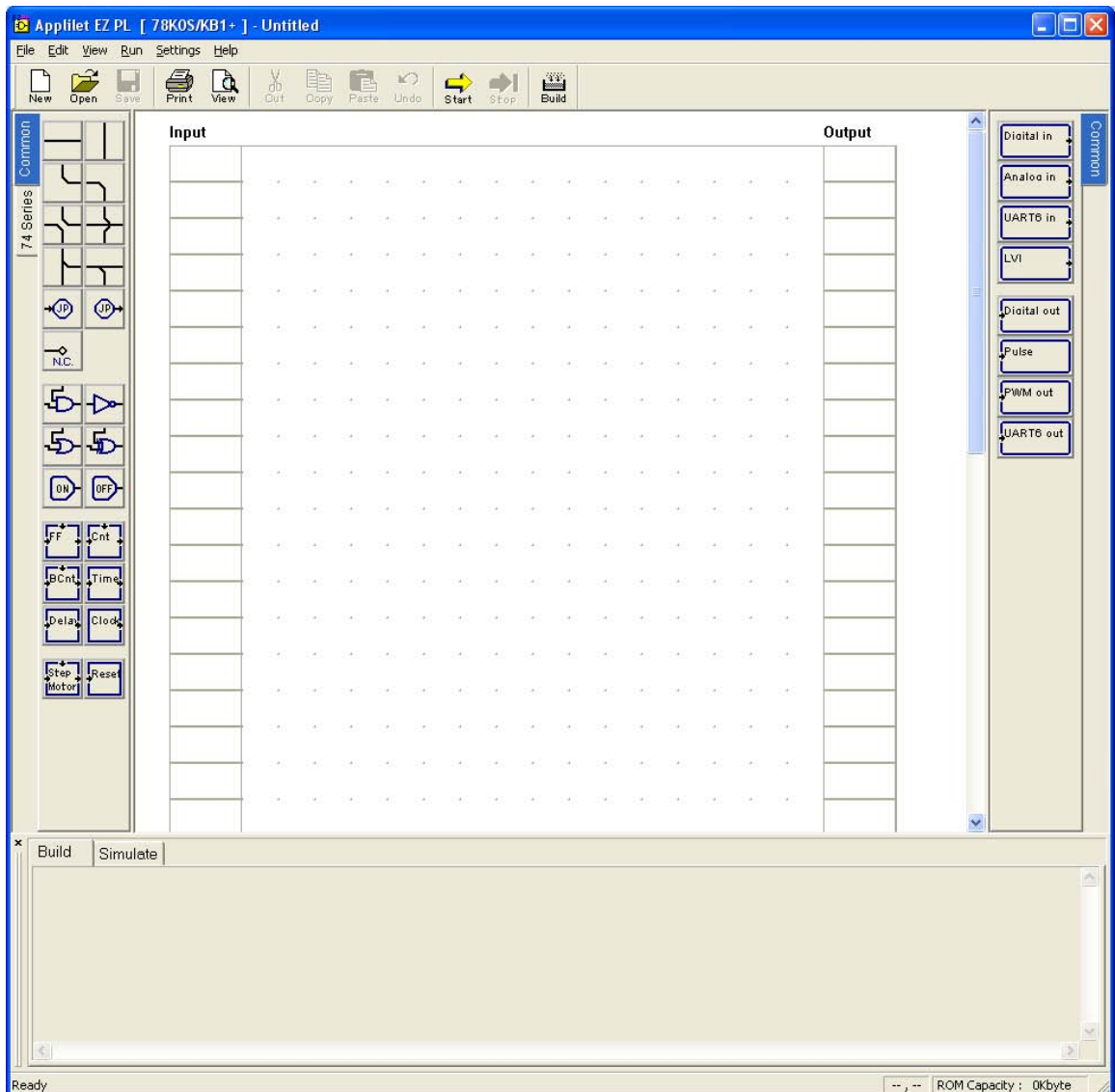

4.2 Closing Applilet EZ PL

Close Applilet EZ PL by selecting the [File] menu and then [Exit].

CHAPTER 5 FUNCTIONS OF Applilet EZ PL

5.1 Basic Functions of Applilet EZ PL

Applilet EZ PL automatically generates object code (*.hex) that can be directly written to the flash memory provided in the 78K0/Kx2, 78K0S/Kx1+, 78K0R/KE3-L, and 78K0/KC2-L just by using the mouse on the GUI.

In Applilet EZ PL, programming elements that are broken down to small module units are provided as panels (see **Figure 5-1**) on the GUI. By logically combining these panels, and assuming the combination as a processing sequence for compilation, software used to control the I/O devices on the evaluation board is automatically generated.

Figure 5-1. Example of Panels on the GUI

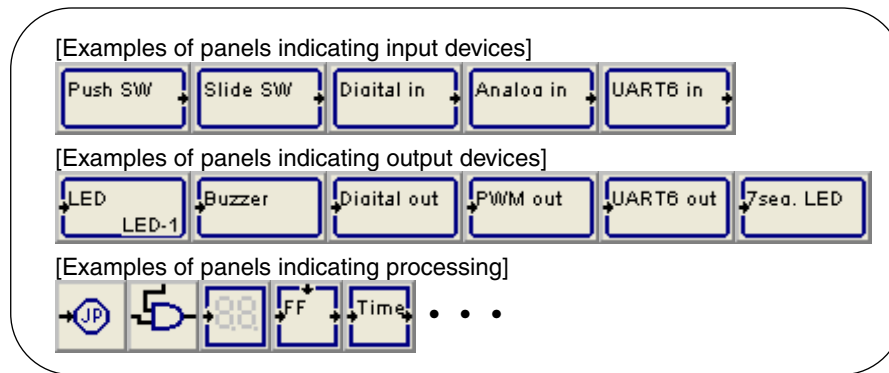
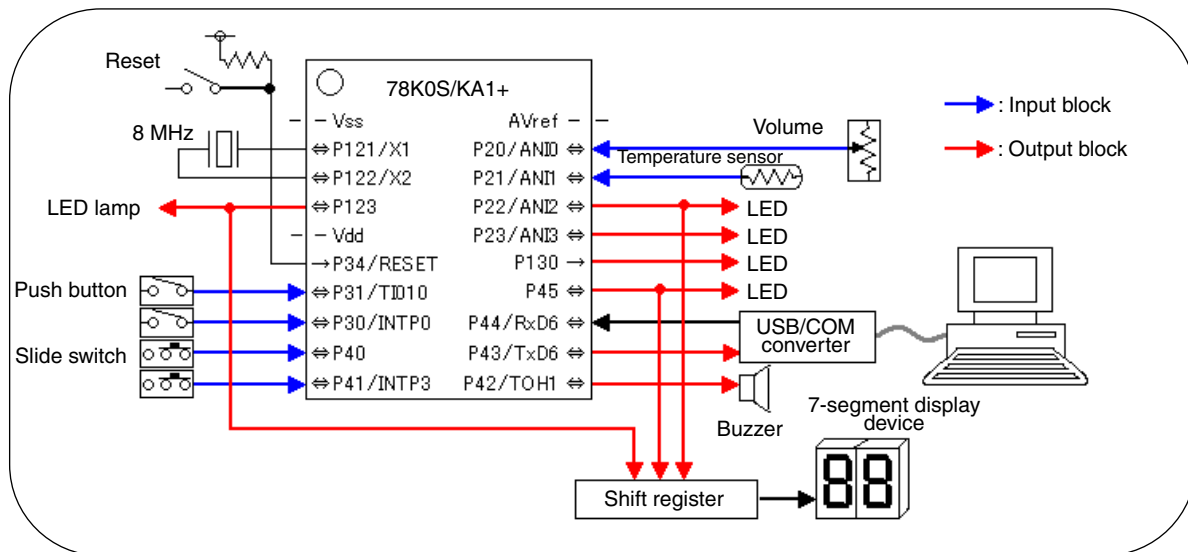

Figure 5-2. Basic I/O Device Connections



[Caution] The types of connected devices and where they are connected differ depending on the evaluation board used.

For details about the connections, see each evaluation board manual.

5.2 Operation Procedure

The operation procedure for automatically generating object code (*.hex) or writing to flash memory by using the basic Applilet EZ PL functions is described below.

5.2.1 Selecting the target CPU

Click the [Settings] menu and then [Target CPU...] to open the Target CPU Settings dialog box (Figure 5-3).

Set up the target to use in this dialog box.

See [Target CPU Settings dialog box](#) for details about the setup.

Figure 5-3. Target CPU Settings Dialog Box

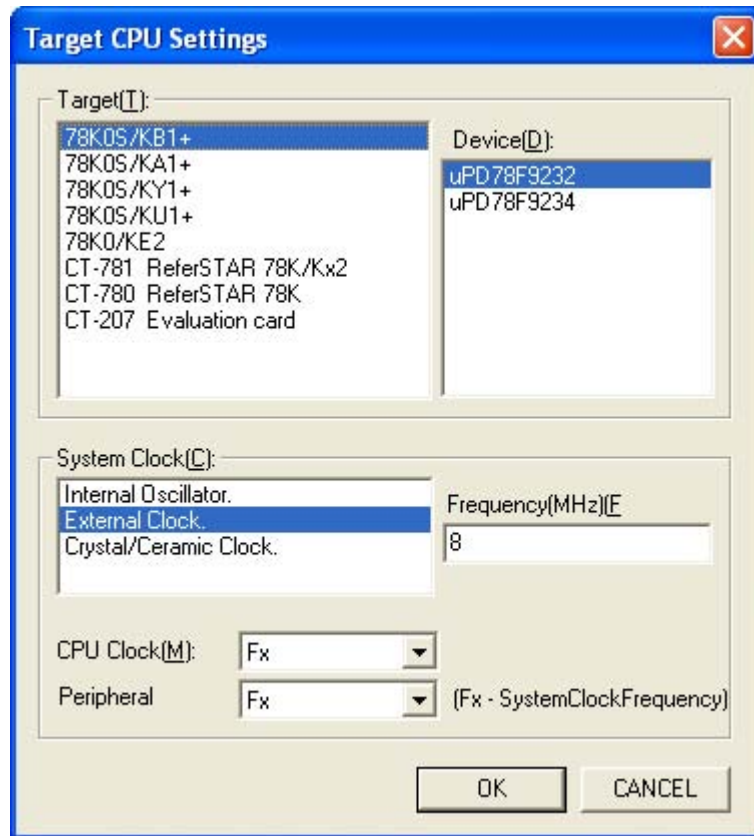

5.2.2 Editing panels

Panels can be edited in the [Main window](#) of Applilet EZ PL, which automatically opens when Applilet EZ PL starts.

In the [Main window](#), various panels that represent programming elements are provided on the left and right sides. These panels can be assigned to an area that is separated into three blocks, the input block, processing block, and output block.

A panel can be edited by assigning it to one of the blocks, such as by dragging and dropping the panel.

Figure 5-4. GUI Used for Editing Panels

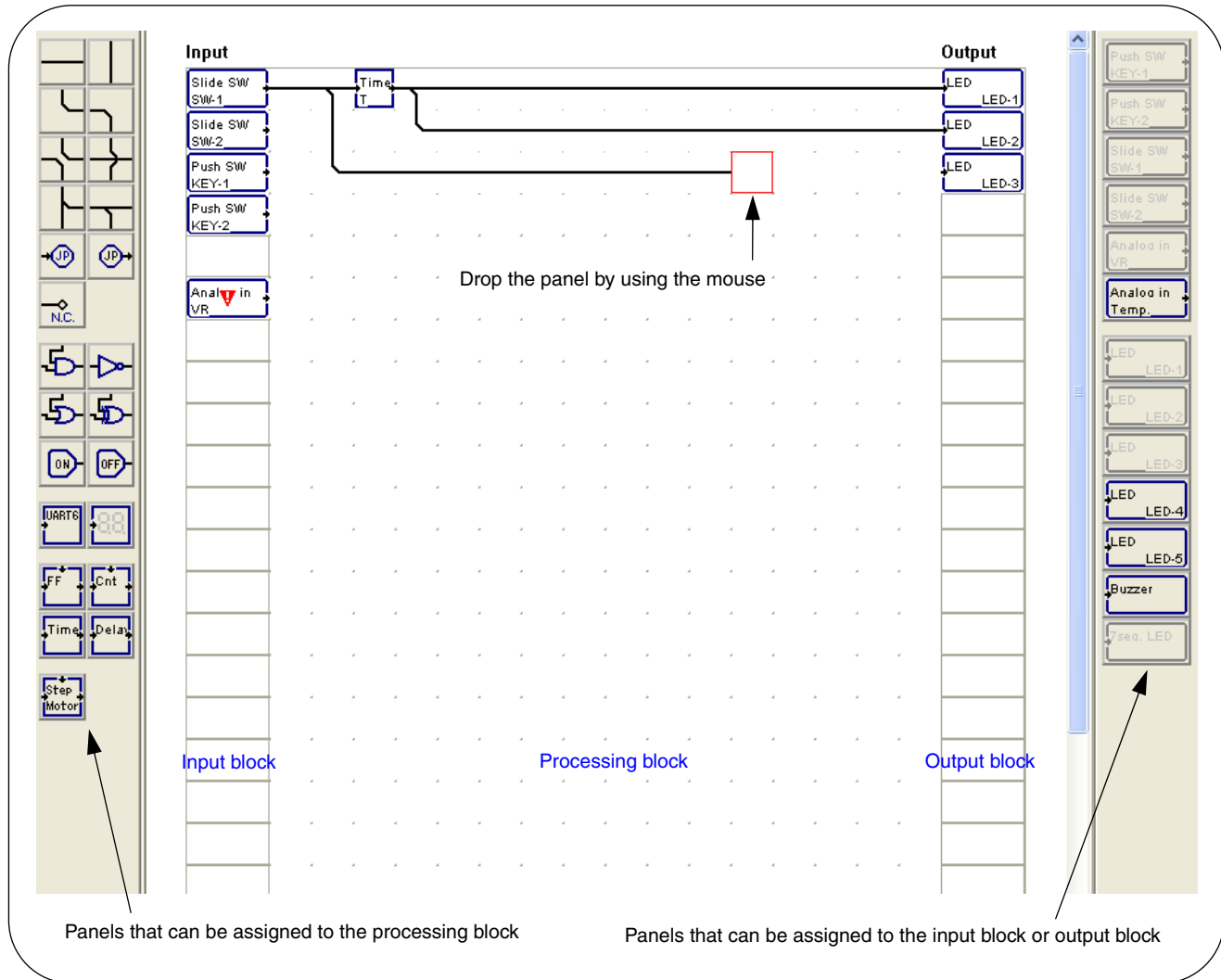

Each panel is assigned assuming that it processes a signal (on or off) from the input block and passes the signal to the output block. (See the section describing the [Main window](#) for details about the function of each panel and how to edit each panel.)

In Applilet EZ PL, by assigning panels to the input, processing, or output block, various inputs to the 78K0/Kx2, 78K0S/Kx1+, 78K0R/KE3-L, or 78K0/KC2-L are converted into binary information according to the type of the panel at the input block and then passed to the processing block. Furthermore, object code (*.hex) that controls the various outputs from the 78K0/Kx2, 78K0S/Kx1+, 78K0R/KE3-L, or 78K0/KC2-L based on the binary information from the processing block according to the type of the panel at the output block is automatically generated.

5.2.3 Checking after editing the panels

Check the items below after the panels are assigned to the input, processing, or output block in the [Main window](#). In Applilet EZ PL, if these conditions are not satisfied, an error is output when the object code (*.hex) is automatically generated and compilation is aborted.

- (1) The required properties of all assigned panels are specified. (The  mark indicates that the properties of the marked panel have not been fully specified.)
- (2) All assigned panels are wired. (Delete all panels not to be used.)
- (3) The same ports are not assigned to multiple I/O panels in the properties. (This can be checked in the [Port Setting dialog box](#).)
- (4) The ROM size does not exceed the size of the flash ROM provided in the product. (Watch the [Status bar](#) when assigning panels [**Note**].)
- (5) No more than 10 instances of the [Counter], [Timer], and [Delay] panels are assigned in total (only for the 78K0S/Kx1+).

[Note] The estimated ROM size differs from the result of actual compilation.

5.2.4 Simulation

Applilet EZ PL can simulate a created program by using panels.

- (1) Click the [Run] menu in the [Main window](#), and then [Start simulation], or click .

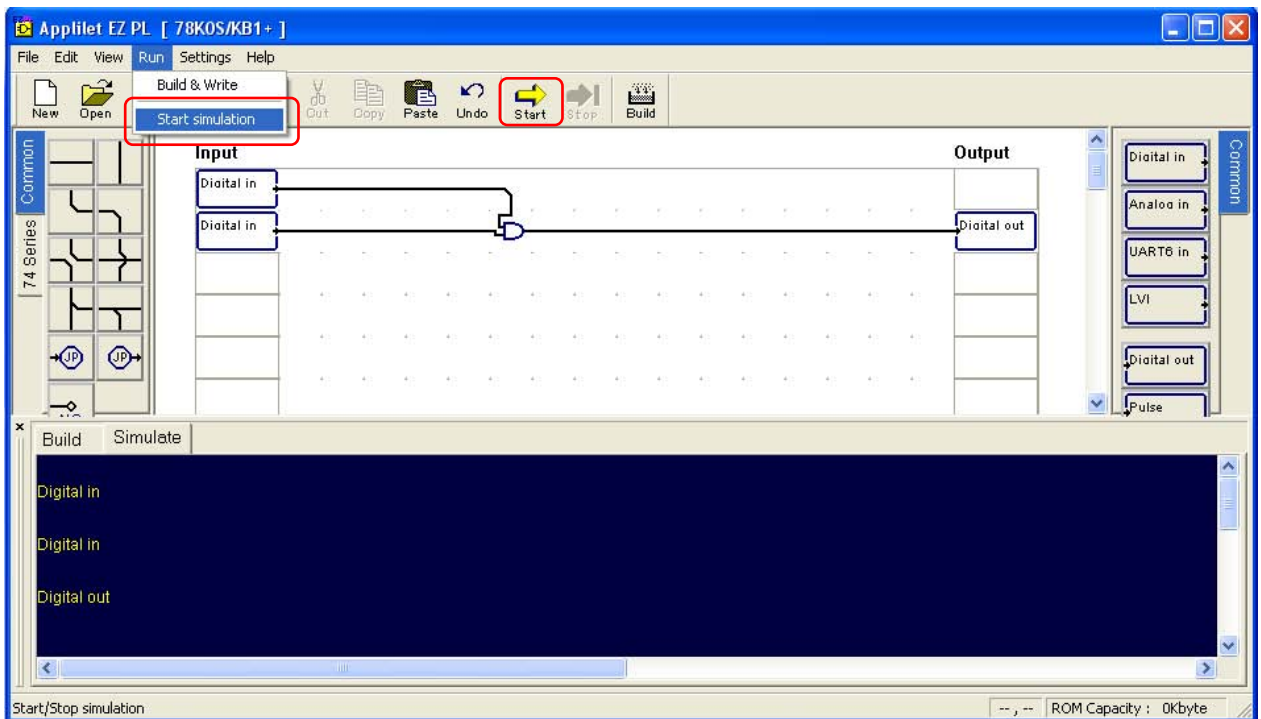

- (2) ON or OFF, which indicates the simulation status, is displayed for panels assigned to the input and output blocks.

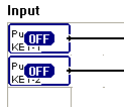

- (3) Clicking the displayed ON or OFF indicator of a panel in the input block, switches the status and then the status of the corresponding panel in the output block is changed accordingly by the operation of a panel assigned to the processing block.
- (4) During simulation, the statuses of the inputs and outputs are displayed in the simulation area and whether the time axis signal is high or low can be checked.

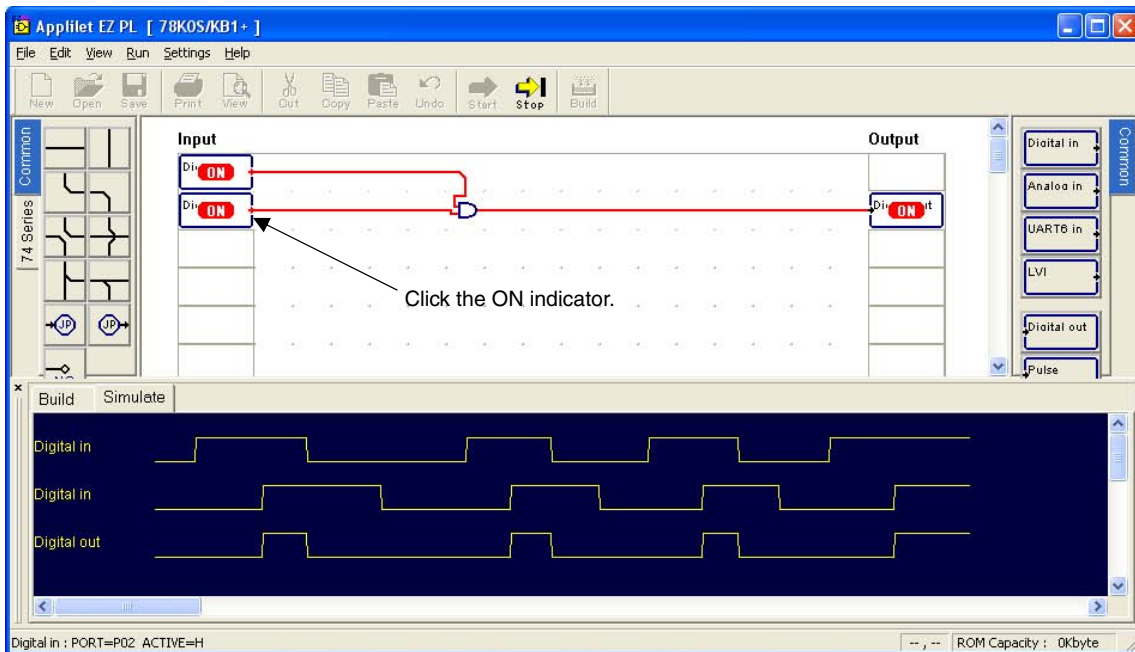

- (5) Simulation can be stopped by clicking the [Run] menu in the [Main window](#) and then [Stop simulation], by clicking , or by clicking the right mouse button at the relevant location in the input, processing, or output block, and then clicking [Stop simulation].

[Caution 1] Only execute simulation after performing the check described in [5.2.3 Checking after editing the panels](#). If simulation is executed while panels are not fully assigned, an unintended operation might occur.

[Caution 2] Simulation is not executed in real-time. The ON/OFF response time, speed of drawing the simulation area, and execution time vary depending on the performance and environment of the PC used.

[Caution 3] During simulation, do not perform operations other than switching the ON/OFF statuses of input panels or stopping simulation.

[Caution 4] Simulation indicates the statuses of the panels at the logical level (ON/OFF). The active level (H/L) of input and output panels is not reflected.

5.2.5 Automatically generating object code

Object code (*.hex) is automatically generated by using the following procedure.

(1) Creating a panel location file

The current panel assignment information is saved to a panel location file (*.loc) by clicking the [File] menu and then [Save as...] or [Save], or by clicking  on the [Toolbar](#). This file includes information about all types, locations, and properties of panels. By reading this file, the previous panel locations can be set up in the [Main window](#) again.

(2) Automatically generating object code

Compilation that automatically generates object code (*.hex) that assumes the current assignment of panels as the processing sequence is executed by clicking the [Run] menu and then [Build & Write], or by clicking  on the [Toolbar](#).

The object code (*.hex) is automatically generated in the same folder as the panel location file (*.loc) saved in step (1). Therefore, when editing panels, object code (*.hex) cannot be generated until a panel location file (*.loc) is generated (by clicking the [File] menu and then [Save as...]).

[Caution] During compilation, Applilet EZ PL automatically generates object code (*.hex) by saving the information about the current panel assignment to a temporary panel location file (*.loc) and then referencing that file. Therefore, if compilation is executed without saving the information about the current panel assignment after editing panels, the saved panel location file (*.loc) and generated object code (*.hex) might not match.

5.2.6 Writing to the 78K0/Kx2, 78K0S/Kx1+, 78K0R/KE3-L, or 78K0/KC2-L (flash writing)

If compilation was completed normally in [\(2\) Automatically generating object code](#), Applilet EZ PL displays the following confirmation message.



If [OK] is clicked, the flash memory provided in the 78K0/Kx2, 78K0S/Kx1+, 78K0R/KE3-L, and 78K0/KC2-L is written to. The write processing differs depending on the target CPU.

- If the 78K0/Kx2, 78K0S/Kx1+, 78K0R/KE3-L, or 78K0/KC2-L is selected (if using a self-built board or the TB board)

The pre-registered flash memory programmer is called. Use this flash memory programmer to write to the flash memory.

For details, see [3.1 Using a Self-Built Board or the TB Board](#).

- If the supported evaluation board is selected
Applilet EZ PL automatically starts writing to the flash memory.

[Caution] To use the supported evaluation board when writing to the flash memory, the evaluation board must be turned on in advance, and the FLASH WRITER and UART switches for the USB port must be toggled to the side of the FLASH WRITER.

To test the operation after writing to the flash memory, toggle these switches to the UART side and then press the reset button after.

Figure 5-5. Operation up to Automatically Generating Object Code and Writing to the Flash Memory

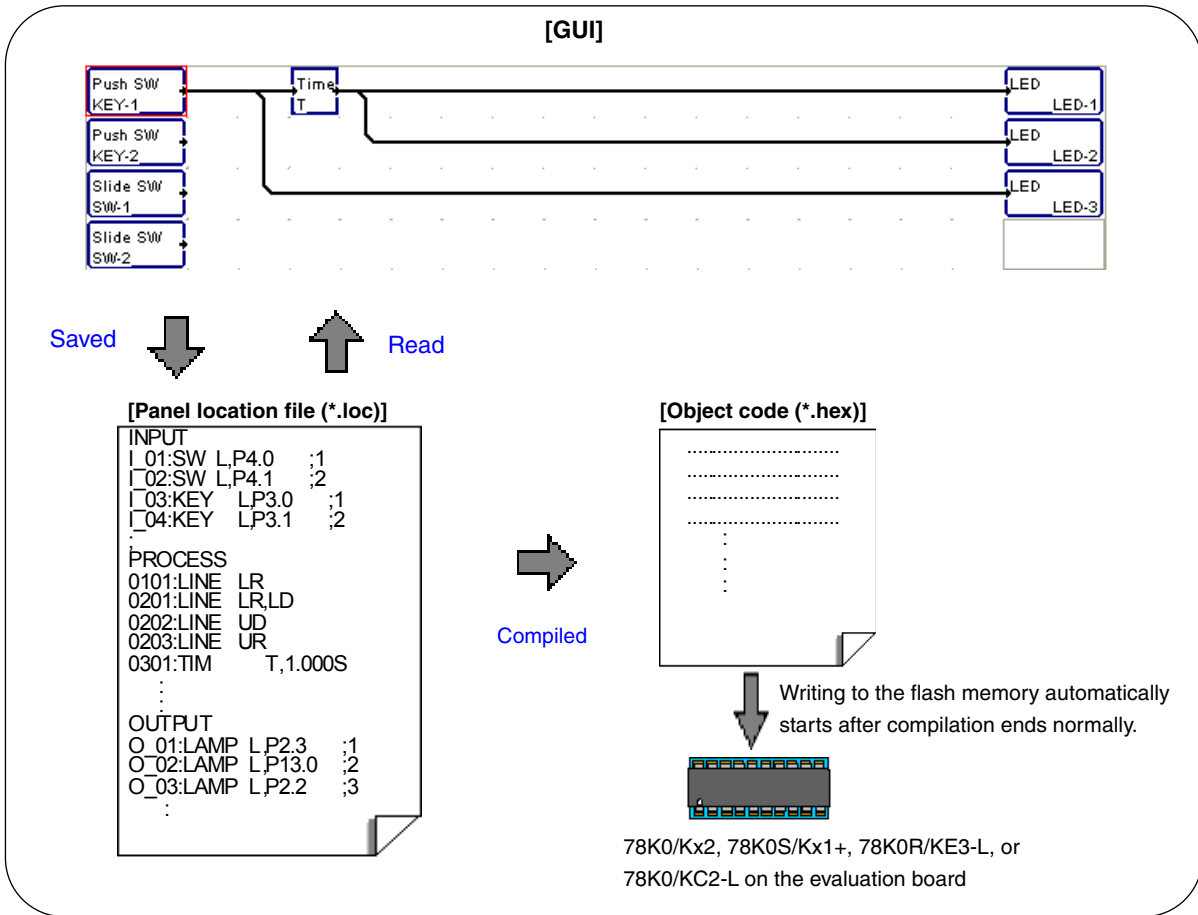

5.2.7 Generating a PM+ project file

If compilation ends normally, a PM+ project file (*.prj) is automatically generated at the same time **[Note]**.

Software generated by using Applilet EZ PL can be learned about and evaluated in more detail by loading this project file to PM+. (For details, see **APPENDIX A AUTOMATICALLY GENERATED FILES (FOR 78K0/Kx2 AND 78K0R/KE3-L)**.)

[Note] For products using a 78K0S microcontroller, only a source file is generated, not a project file.

CHAPTER 6 WINDOW REFERENCE

6.1 Overview of Windows and Dialog Boxes

The following windows and dialog boxes are used in Applilet EZ PL.

Table 6-1. Windows and Dialog Boxes Used in Applilet EZ PL

Name of Window or Dialog Box	Functional Overview
Main window	This window automatically opens when Applilet EZ PL starts. Panels are edited in this window.
Property Settings dialog box	This dialog box is used to specify panel properties. The dialog box differs depending on the panel type.
Port Setting dialog box	This dialog box displays the I/O ports specified in the properties.
Target CPU Settings dialog box	This dialog box is used to specify the device or board and the system clock source to be used.
Watchdog Timer Setting dialog box	This dialog box is used to select and set up the watchdog timer.
UART0 Settings dialog box	This dialog box displays the UART0 I/O properties.
UART1 Settings dialog box	This dialog box displays the UART1 I/O properties.
UART6 Settings dialog box	This dialog box displays the UART6 I/O properties.
Flash Memory Programmer Settings dialog box	<p>This dialog box is used to set up the flash memory programmer used for writing to the flash memory.</p> <p>Different items are displayed depending on the device or board selected in the Target CPU Settings dialog box.</p> <ul style="list-style-type: none"> • If the 78K0S/Kx1+, 78K0/Kx2, 78K0R/KE3-L, 78K0/KC2-L, TK-78K0R/KE3L, or TK-78K0/KC2L is selected <p>A dialog box for adding the flash memory programmer is displayed. Enter the installation path and file name of any flash memory programmer. A start option can also be entered.</p> <ul style="list-style-type: none"> • If a different device is selected <p>Set up the COM ports connected to each product and waits.</p>
Saved Data Folder dialog box	This dialog box is used to specify where to save data.

6.2 Description of Each Window and Dialog Box

Each window and dialog box used in Applilet EZ PL is described in the following format. (The main window is used as an example.)

Main window

Window or dialog box name

This window automatically opens when Applilet EZ PL starts.

In Applilet EZ PL, object code (*.hex) that can be directly written to the flash memory provided in the 78K0/Kx2, 78K0S/Kx1+, 78K0R/KE3-L, or 78K0/KC2-L is automatically generated by assigning the panels provided on the pallet in this window to the editing area based on the processing to be performed.

⋮
⋮
⋮
⋮
⋮
⋮
⋮

A function overview is provided and how to open the window or dialog box is described.

A screenshot of the window or dialog box and function details are shown.

Main window

This window automatically opens when Applilet EZ PL starts.

In Applilet EZ PL, object code (*.hex) that can be directly written to the flash memory provided in the 78K0/Kx2, 78K0S/Kx1+, 78K0R/KE3-L, or 78K0/KC2-L is automatically generated by assigning the panels provided on the pallet in this window to the editing area based on the processing to be performed.

Figure 6-1. Main Window

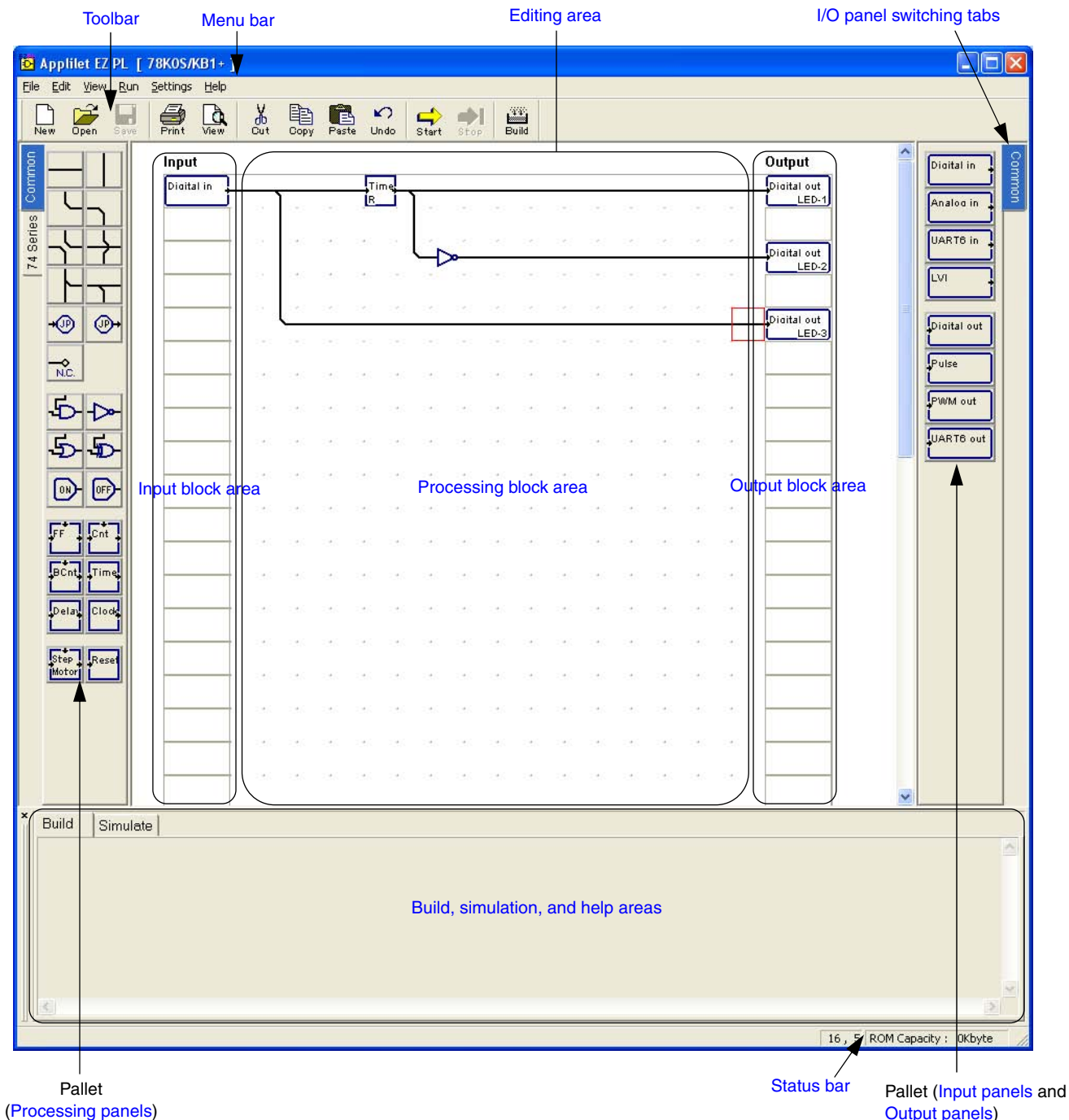

[Caution] The main window differs depending on the “Target” setting in the [Target CPU Settings dialog box](#) that opened by clicking the [Settings] menu and then [Target CPU...].
Be sure to perform the setup corresponding to the CPU to be used.

The following items are described in this section:

- [Editing area](#)
- [Build, simulation, and help areas](#)
- [Panel functions](#)
- [Editing panels](#)
- [Saving and reading data](#)
- [Automatically generating object code and writing to flash memory](#)
- [Right-click menu](#)
- [Menu bar](#)
- [Toolbar](#)
- [Status bar](#)

Editing area

Panels are edited in this area.

The editing area is divided into three areas, each for a different purpose.

(1) Input block area

Panels indicating devices that process inputs to the 78K0/Kx2, 78K0S/Kx1+, 78K0R/KE3-L, or 78K0/KC2-L are assigned to this area. It is made up of 40 blocks vertically. Signals according to the properties of the panels assigned to this area are assumed to be values input to the 78K0/Kx2, 78K0S/Kx1+, 78K0R/KE3-L, or 78K0/KC2-L and are passed to the processing block. (All signals are either on or off.)

Only [Input panels](#) can be assigned to this area.

(2) Processing block area

This area is used to edit the processing to pass signals from the panels assigned to the input block to the output block. It is made up of 40 by 16 blocks. The processing of a panel assigned to a block uses the signal from the adjacent block to the left and above as the input and outputs the signal to the block to the right and below.

A signal according to the panel assigned to the block at the last column of this area is passed to the output block.

Only [Processing panels](#) can be assigned to this area.

(3) Output block area

Panels indicating devices that process outputs from the 78K0/Kx2, 78K0S/Kx1+, 78K0R/KE3-L, or 78K0/KC2-L are assigned to this area. It is made up of 40 blocks vertically. Various signals output from the 78K0/Kx2, 78K0S/Kx1+, 78K0R/KE3-L, or 78K0/KC2-L are controlled based on the signal passed from the block at the last column of the processing block area according to the properties of the panels assigned to this area.

Only [Output panels](#) can be assigned to this area.

Build, simulation, and help areas

These areas include build, simulation, and help areas.

The areas are switched between by clicking the tabs on the top left.

(1) Build area

After editing the panels in the editing area and compiling them by clicking the [Run] menu and then [Build & Write], or by clicking , the compilation result will be displayed in this area.

(2) Simulation area

After editing the panels in the editing area and simulating them by clicking the [Run] menu and then [Start simulation], or by clicking , the output waveforms (H or L) of the panels being simulated will be displayed in this area.

Figure 6-2. Simulation Area



(3) Help area

This area displays details about each panel, such as the name and function.

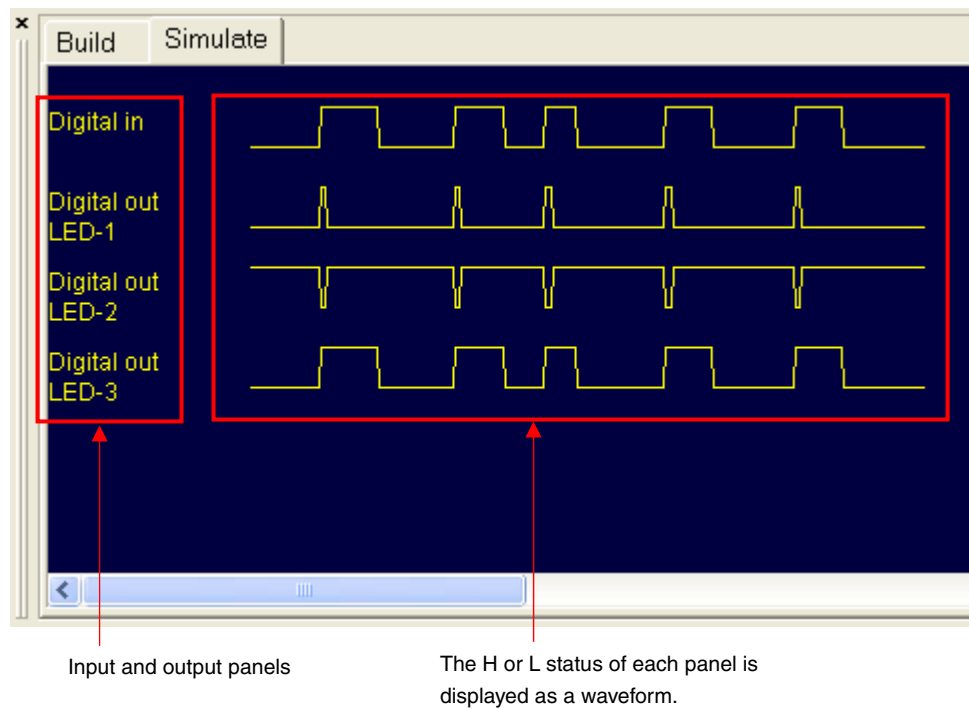
The details about a panel on the pallet can be displayed by clicking the panel, right-clicking, and then selecting [Description].

The details about a panel assigned to the processing area can be displayed by clicking the panel, right-clicking, and then selecting [Description], or by clicking the panel, the [Help] menu, and then [Panel Description].

Panel functions

The functions of the [Input panels](#), [Output panels](#), and [Processing panels](#) provided on the pallet are described below.

The properties of panels that are used (assigned) during editing must be specified according to their purpose. (Some panel properties are not specifiable, and some are not required.) The panels marked by a  mark in the editing area indicates that the properties of the marked panel have not been fully specified.

For details about how to specify the properties of each panel, see the section describing the [Property Settings dialog box](#).

(1) I/O panel switching tabs

According to their purpose, input and output panels are displayed on the pallet on separate tabs. Edit panels by switching between the tabs as required.

The tab names and the panel categories are as follows.

(a) [Common] tab

Panels that indicate general-purpose I/O devices are organized on this tab.

This tab is displayed for any product.

(b) [Evaluation Board I/Os] tab

Panels that indicate I/O devices on an evaluation board are organized on this tab (example: [TK-78K0R/KE3L I/Os] tab).

This tab is displayed if an evaluation board was selected in the Target CPU Settings dialog box.

(c) [Other I/Os] tab

Panels that indicate devices not provided on an evaluation board are organized on this tab.

This tab is displayed if the 78K0/Kx2, 78K0/KC2-L, or TK-78K0/KC2L was selected in the Target CPU Settings dialog box.

(2) Input panels



Input panels can be assigned to the input block area and include the following.





(a) [Common] tab

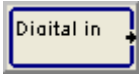

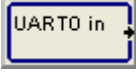

The properties of the input panels on the [Common] tab that are assigned to the pallet are not specified by default (except the active level), so that the panels can be flexibly edited. Therefore, the properties of all the panels assigned to the input block area must be specified.

Multiple instances of each panel on the [Common] tab can be assigned to the input block area and the properties of each instance can be specified.

Table 6-2. Input Panels ([Common] Tab)

Panel	Description	
	Name	Digital input
	Function	This panel represents a digital input. It can be used to turn chattering protection on or off.
	Names of supported devices and boards	All products
	Default properties	<ul style="list-style-type: none"> - Displayed name: None - Assigned ports: None (must be specified) - Active: H - Chattering removal: Not checked 👉 Property settings of [Digital input] panel
	Name	Analog input
	Function	<p>This panel represents an analog input. It is used to process analog inputs using the built-in A/D converter of the 78K0/Kx2, 78K0S/Kx1+, 78K0R/KE3-L, or 78K0/KC2-L.</p> <p><u>Compare type</u></p> <p>If the A/D converted value is at least the value specified in the properties or in the range of the specified values, output is enabled. If multiple values are specified, the panel is stretched vertically (up to 10 stages) and the outputs corresponding to the specified values can be passed to the processing block.</p> <p><u>Bit type</u></p> <p>If the bits of the A/D converted value are 1, the bits are enabled and output. The panel is stretched vertically (up to 8 stages) according to the specified number of output bits (outputting the higher <i>n</i> bits) and the outputs corresponding to the specified bits can be passed to the processing block.</p>
	Names of supported devices and boards	μPD78F92xx among 78K0S/Kx1+ products, 78K0/Kx2, 78K0R/KE3-L, 78K0/KC2-L, TK-78K0R/KE3L, TK-78K0/KC2L
	Default properties	<ul style="list-style-type: none"> - Displayed name: None - Assigned ports: None (must be specified) - Gain of operational amplifier (78K0R/KE3-L and TK-78K0R/KE3L only): This can be specified only if P80/CMP0P/INTP3/OAI is selected for the port to be assigned (must be specified). - Type: None (must be specified) 👉 Property settings of [Analog input] panel

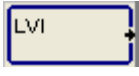
Panel	Description	
	Name	UART6 input
	Function	<p>This panel is used to perform UART reception (by using the serial interface UART6).</p> <p><u>Compare type</u></p> <p>If the received data matches the value specified in the properties, output is enabled. If multiple values are specified, the panel is stretched vertically (up to 10 stages) and the outputs corresponding to the specified values can be passed to the processing block.</p> <p><u>Bit type</u></p> <p>If the bits of the received data are 1, the bits are enabled and output. The panel is stretched vertically (up to 8 stages) according to the specified number of output bits (outputting the higher <i>n</i> bits) and the outputs corresponding to the specified bits can be passed to the processing block.</p>
	Names of supported devices and boards	78K0S/KB1+, 78K0S/KA1+, 78K0/Kx2, 78K0/KC2-L, TK-78K0/KC2L
	Default properties	<ul style="list-style-type: none"> - Displayed name: None - Assigned ports: P14/RxD6 (for 78K0/Kx2, 78K0/KC2-L, TK-78K0/KC2L) P44/RxD6 (for 78K0S/KB1+ and 78K0S/KA1+) - Selected type: None (must be specified) <p> Property settings of [UART6 input] panel</p>
	Name	UART0 input
	Function	<p>This panel is used to perform UART reception (by using the serial interface UART0).</p> <p><u>Compare type</u></p> <p>If the received data matches the value specified in the properties, output is enabled. If multiple values are specified, the panel is stretched vertically (up to 10 stages) and the outputs corresponding to the specified values can be passed to the processing block.</p> <p><u>Bit type</u></p> <p>If the bits of the received data are 1, the bits are enabled and output. The panel is stretched vertically (up to 8 stages) according to the specified number of output bits (outputting the higher <i>n</i> bits) and the outputs corresponding to the specified bits can be passed to the processing block.</p>
	Names of supported devices and boards	78K0Kx2, 78K0R/KE3-L, TK-78K0R/KE3L
	Default properties	<ul style="list-style-type: none"> - Displayed name: None - Assigned ports: P11/SI10/RxD0 (for 78K0/Kx2) P74/KR4/SI00/RxD0 (for 78K0R/KE3-L and TK-78K0R/KE3L) - Selected type: None (must be specified) <p> Property settings of [UART0 input] panel</p>

Panel	Description	
	Name	UART1 input
	Function	<p>This panel is used to perform UART reception (by using the serial interface UART1).</p> <p><u>Compare type</u></p> <p>If the received data matches the value specified in the properties, output is enabled. If multiple values are specified, the panel is stretched vertically (up to 10 stages) and the outputs corresponding to the specified values can be passed to the processing block.</p> <p><u>Bit type</u></p> <p>If the bits of the received data are 1, the bits are enabled and output. The panel is stretched vertically (up to 8 stages) according to the specified number of output bits (outputting the higher <i>n</i> bits) and the outputs corresponding to the specified bits can be passed to the processing block.</p>
	Names of supported devices and boards	78K0R/KE3-L, TK-78K0R/KE3L
	Default properties	<ul style="list-style-type: none"> - Displayed name: None - Assigned ports: P31/SI10/RxD1/SDSA10/INTP1 - Selected type: None (must be specified) <p> Property settings of [UART1 input] panel</p>
	Name	LVI
	Function	This panel compares the voltage and set value of V_{DD} or EXLVI by using low-voltage detection (LVI).
	Names of supported devices and boards	78K0S/Kx1+, 78K0/Kx2, 78K0R/KE3-L, 78K0/KC2-L, TK-78K0R/KE3L, TK-78K0/KC2L
	Default properties	<ul style="list-style-type: none"> - Displayed name: None - Voltage detection pin: None (must be specified) - Detection level: Can be specified if the voltage detection pin is specified (must be specified) <p> Property settings of [LVI] panel</p>

(b) [TK-78K0R/KE3L I/Os] and [TK-78K0/KC2L I/Os] tabs



The properties of the input panels assigned to the pallet on the [TK-78K0R/KE3L I/Os] and [TK-78K0/KC2L I/Os] tabs, such as the assigned ports, are specified by default, so the input devices on the evaluation board can be used as they are.

Therefore, only the properties of the panels assigned to the input block area, which must be added or corrected, can be specified. (The properties of assigned panels marked with a  mark in the editing area must be specified.)

Only one instance of each panel on these tabs can be assigned to the input block area, and panels are displayed in gray after being assigned.



[Caution] The ports assigned to each of the panels on this tab cannot be changed. (Other default properties can be changed.)

Table 6-3. Input Panels ([TK-78K0R/KE3L I/Os] and [TK-78K0/KC2L I/Os] Tabs)

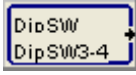
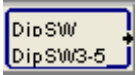
Panel	Description	
	Name	Push button
	Function	This panel represents a push button switch. It can be used to turn chattering protection on or off.
	Names of supported boards	TK-78K0R/KE3L, TK-78K0/KC2L
	Default properties	<ul style="list-style-type: none"> - Displayed name: SW5 - Assigned ports: P120/INTP0/EXLVI (for TK-78K0R/KE3L) P30/INTP1 (for TK-78K0/KC2L) - Active: L - Chattering removal: Checked - Removal time: 30 ms Property settings of [Push button] panel
	Name	Push button
	Function	This panel represents a push button switch. It can be used to turn chattering protection on or off.
	Names of supported boards	TK-78K0R/KE3L, TK-78K0/KC2L
	Default properties	<ul style="list-style-type: none"> - Displayed name: SW6 - Assigned ports: P32/SCK10/SCL10/INTP2 (for TK-78K0R/KE3L) P33/TI51/TO51/INTP4 (for TK-78K0/KC2L) - Active: L - Chattering removal: Checked - Removal time: 30 ms Property settings of [Push button] panel

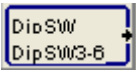
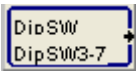
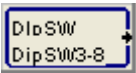
Panel	Description	
	Name	DIP switch
	Function	This panel represents a DIP switch. It can be used to turn chattering protection on or off.
	Names of supported boards	TK-78K0R/KE3L, TK-78K0/KC2L
	Default properties	<ul style="list-style-type: none"> - Displayed name: DIP SW3-4 - Assigned ports: P33 (for TK-78K0R/KE3L) P70/KR0 (for TK-78K0/KC2L) - Active: L - Chattering removal: Checked - Removal time: 50 ms 👉 Property settings of [DIP switch] panel
	Name	DIP switch
	Function	This panel represents a DIP switch. It can be used to turn chattering protection on or off.
	Names of supported boards	TK-78K0R/KE3L, TK-78K0/KC2L
	Default properties	<ul style="list-style-type: none"> - Displayed name: DIP SW3-5 - Assigned ports: P42 (for TK-78K0R/KE3L) P71/KR1 (for TK-78K0/KC2L) - Active: L - Chattering removal: Checked - Removal time: 50 ms 👉 Property settings of [DIP switch] panel

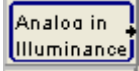
Panel	Description	
	Name	DIP switch
	Function	This panel represents a DIP switch. It can be used to turn chattering protection on or off.
	Names of supported boards	TK-78K0R/KE3L, TK-78K0/KC2L
	Default properties	<ul style="list-style-type: none"> - Displayed name: DIP SW3-6 - Assigned ports: P43 (for TK-78K0R/KE3L) P72/KR2 (for TK-78K0/KC2L) - Active: L - Chattering removal: Checked - Removal time: 50 ms 👉 Property settings of [DIP switch] panel
	Name	DIP switch
	Function	This panel represents a DIP switch. It can be used to turn chattering protection on or off.
	Names of supported boards	TK-78K0R/KE3L, TK-78K0/KC2L
	Default properties	<ul style="list-style-type: none"> - Displayed name: DIP SW3-7 - Assigned ports: P77/KR7 (for TK-78K0R/KE3L) P73/KR3 (for TK-78K0/KC2L) - Active: L - Chattering removal: Checked - Removal time: 50 ms 👉 Property settings of [DIP switch] panel
	Name	DIP switch
	Function	This panel represents a DIP switch. It can be used to turn chattering protection on or off.
	Names of supported boards	TK-78K0R/KE3L, TK-78K0/KC2L
	Default properties	<ul style="list-style-type: none"> - Displayed name: DIP SW3-8 - Assigned ports: P76/KR6 (for TK-78K0R/KE3L) P74/KR4 (for TK-78K0/KC2L) - Active: L - Chattering removal: Checked - Removal time: 50 ms 👉 Property settings of [DIP switch] panel

Panel	Description	
	Name	Analog input (illuminance)
	Function	<p>This panel indicates the illuminance.</p> <p>It is used to process analog inputs using the built-in A/D converter of the 78K0R/KE3-L or 78K0/KC2-L.</p> <p><u>Compare type</u></p> <p>If the A/D converted value is at least the value specified in the properties or in the range of the specified values, output is enabled. If multiple values are specified, the panel is stretched vertically (up to 10 stages) and the outputs corresponding to the specified values can be passed to the processing block.</p> <p><u>Bit type</u></p> <p>If the bits of the A/D converted value are 1, the bits are enabled and output. The panel is stretched vertically (up to 8 stages) according to the specified number of output bits (outputting the higher <i>n</i> bits) and the outputs corresponding to the specified bits can be passed to the processing block.</p>
	Names of supported boards	TK-78K0R/KE3L, TK-78K0/KC2L
	Default properties	<ul style="list-style-type: none"> - Displayed name: Illuminance - Assigned ports: P80/CMP0P/INTP3/OAI (for TK-78K0R/KE3L) P10/ANI8/AMP1-/SCK10 (for TK-78K0/KC2L) - Selected type: None (must be specified) <p> Property settings of [Analog input (illuminance)] panel</p>

(3) Output panels



Output panels can be assigned to the output block area and include the following.





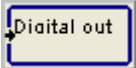
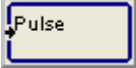

(a) [Common] tab



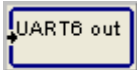

The properties of the output panels on the [Common] tab that are assigned to the pallet are not specified by default (except the active level), so that the panels can be flexibly edited. Therefore, the properties of all the panels assigned to the output block area must be specified.

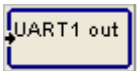
Multiple instances of each panel on the [Common] tab can be assigned to the output block area and the properties of each instance can be specified.

Table 6-4. Output Panels ([Common] Tab)

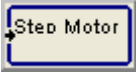
Panel	Description	
	Name	Digital output
	Function	This panel represents a digital output. It is used to process the output of a port.
	Names of supported devices and boards	All products
	Default properties	<ul style="list-style-type: none"> - Displayed name: None - Assigned ports: None (must be specified) - Active: H 👉 Property settings of [Digital output] panel
	Name	Simple PWM
	Function	This panel outputs a pulse to the digital output port. The panel is stretched vertically (to three or five stages) by specifying the duty factor in the properties, and a pulse is output by inputting a 1 for each duty factor. (The frequency cannot be specified).
	Names of supported devices and boards	All products
	Default properties	<ul style="list-style-type: none"> - Displayed name: None - Assigned ports: None (must be specified) - Active: H (fixed) - Output: None (must be selected from the specified values) 👉 Property settings of [Simple PWM] panel
	Name	PWM output
	Function	This panel is used to perform PWM (pulse width modulation) using timer output of the 78K0/Kx2, 78K0S/Kx1+, 78K0R/KE3-L, or 78K0/KC2-L. The panel is stretched vertically (up to 15 stages) by specifying multiple duty factors in the properties, and a PWM signal is output with the specified duty factor by inputting a 1 for each duty factor. (If multiple 1s are input at the same time, 0s are output.)
	Names of supported devices and boards	μPD78F92xx among 78K0S/Kx1+ products, 78K0/Kx2, 78K0R/KE3-L, 78K0/KC2-L, TK-78K0R/KE3L, TK-78K0/KC2L
	Default properties	<ul style="list-style-type: none"> - Assigned ports: See Property settings of [PWM output] panel. - Frequency: None (must be specified) - Duty factor: None (must be specified) 👉 Property settings of [PWM output] panel

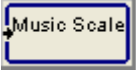
Panel	Description	
	Name	UART6 output
	Function	<p>This panel is used to perform UART transmission (by using the serial interface UART6).</p> <p>A panel that has the number of stages equivalent to the data bit length is assigned to the output block area by specifying the communication parameters.</p> <p>Transmission starts when the input is enabled.</p> <p>Specify the communication parameters in the UART6 Settings dialog box opened by clicking the [Settings] menu, [CPU Function], and then [UART6].</p> <p>Remark To use this panel in Applilet EZ PL V3.6 or an older version, assign it with the [UART6 jumper output] processing panel.</p>
	Names of supported devices and boards	78K0S/KB1+, 78K0S/KA1+, 78K0/Kx2, 78K0/KC2-L, TK-78K0/KC2L
	Default properties	<p>- Assigned ports: P13/TxD6 (for 78K0/Kx2, 78K0/KC2-L, and TK-78K0/KC2L) P43/TxD6/INTP1 (for 78K0S/KB1+ and 78K0S/KA1+)</p> <p> Property settings of [UART6 output] panel</p>
	Name	UART0 output
	Function	<p>This panel is used to perform UART transmission (by using the serial interface UART0).</p> <p>A panel that has the number of stages equivalent to the data bit length is assigned to the output block area by specifying the communication parameters.</p> <p>Transmission starts when the input is enabled.</p> <p>Specify the communication parameters in the UART0 Settings dialog box opened by clicking the [Settings] menu, [CPU Function], and then [UART0].</p> <p>Remark To use this panel in Applilet EZ PL V3.6 or an older version, assign it with the [UART0 jumper output] processing panel.</p>
	Names of supported devices and boards	78K0/Kx2, 78K0R/KE3-L, TK-78K0R/KE3L
	Default properties	<p>- Assigned ports: P10/SCK10/TxD0 (for 78K0/Kx2) P73/KR3/SO00/TxD0 (for 78K0R/KE3-L and TK-78K0R/KE3L)</p> <p> Property settings of [UART0 output] panel</p>
	Name	UART1 output
	Function	<p>This panel is used to perform UART transmission (by using the serial interface UART1).</p> <p>A panel that has the number of stages equivalent to the data bit length is assigned to the output block area by specifying the communication parameters.</p> <p>Transmission starts when the input is enabled.</p> <p>Specify the communication parameters in the UART1 Settings dialog box opened by clicking the [Settings] menu, [CPU Function], and then [UART1].</p>
	Names of supported devices and boards	78K0R/KE3-L, TK-78K0R/KE3L
	Default properties	<p>- Assigned ports: P30/SO10/TxD1</p> <p> Property settings of [UART1 output] panel</p>

Panel	Description	
	Name	Step motor
	Function	This panel outputs a signal for controlling a four-stage stepping-motor. The size of the panel to be assigned to the editing area is two stages (vertical). By inputting information from the Enable section, the stepping motor is rotated (on) or stopped (off). By inputting information from the Dir section, a signal for processing forward rotation (on) or reverse rotation (off) is output.
	Names of supported devices and boards	78K0/Kx2, 78K0R/KE3-L, 78K0/KC2-L, TK-78K0R/KE3L, TK-78K0/KC2L
	Default properties	- Assigned ports: None (must be specified) - Rotation speed: None (must be specified) - Excitation method: None (must be specified)  Property settings of [Step motor] panel
	Name	Musical-scale output
	Function	This panel outputs a square wave, which matches the specified musical scale of the input, from an output pin by using the square wave output function of a timer.
	Names of supported devices and boards	μPD78F0534 to 78F0537 among 78K0/KE2 products, 78K0/KF2, 78K0R/KE3-L, TK-78K0R/KE3L
	Default properties	- Output pin: P06/TI011/TO01 (for 78K0/KE2 and 78K0/KF2) None (must be specified) (for 78K0R/KE3-L and TK-78K0R/KE3L) - Musical output range: None (must be specified)  Property settings of [Musical-scale output] panel

(b) [TK-78K0R/KE3L I/Os] and [TK-78K0/KC2L I/Os] tabs



The properties of the output panels assigned to the pallet on the [TK-78K0R/KE3L I/Os] and [TK-78K0/KC2L I/Os] tabs, such as the assigned ports, are specified by default, so the output devices on the evaluation board can be used as they are.

Therefore, only the properties of the panels assigned to the output block area, which must be added or corrected, can be specified. (The properties of assigned panels marked with a  mark in the editing area must be specified.)

Only one instance of each panel on these tabs can be assigned to the output block area, and panels are displayed in gray after being assigned.

[Caution] The ports assigned to each of the panels on this tab cannot be changed. (Other default properties can be changed.)

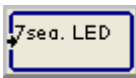
Table 6-5. Output Panels ([TK-78K0R/KE3L I/Os] and [TK-78K0/KC2L I/Os] Tabs)

Panel	Description	
	Name	7-segment display
	Function	<p>This panel represents the 7-segment LED jumper exit. It is used to light a 7-segment LED if the input is enabled. This panel is assigned with the [7-segment LED jumper] processing panel. To use a 7-segment LED, the display type must be prespecified by specifying the properties of this panel. (The display of the [7-segment LED jumper] panel changes according to the specified display type.)</p> <p>Caution 7-segment LEDs of different display types cannot be used at the same time. Therefore, if the display type is changed during editing by specifying the properties of this panel, the [7-segment LED jumper] panel already assigned to the editing area will be displayed as by default and the properties must be respecified.</p>
	Names of supported boards	TK-78K0R/KE3L, TK-78K0/KC2L
	Default properties	<ul style="list-style-type: none"> - Assigned ports: P00, P01, and P20 to P27 (for TK-78K0R/KE3L and TK-78K0/KC2L) - Display type: None (must be specified) <p> Property settings of [7-segment display] panel</p>





(c) [Other I/Os] tab

The output panels assigned to the pallet on the [Other I/Os] tab are used to enable output devices not provided on the evaluation board for use.

Only one instance of each panel on this tab can be assigned to the output block area, and panels are displayed in gray after being assigned.

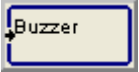
[Caution] The ports assigned to each of the panels on this tab cannot be changed.

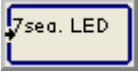
Table 6-6. Output Panels ([Other I/Os] Tab)

Panel	Description	
	Name	Buzzer
	Function	This panel is used to sound the buzzer. By specifying multiple output frequencies in the properties, the panel is stretched vertically (up to three stages), the input is enabled for each output frequency, and a square wave of each specified frequency is output. (The output frequencies are undefined if multiple inputs are enabled at the same time.)
	Names of supported devices and boards	78K0/Kx2, 78K0/KC2-L, TK-78K0/KC2L
	Default properties	- Assigned ports: P15/TOH0 - Output frequency: None (must be selected from the specified values)  Property settings of [Buzzer] panel
	Name	7-segment display
	Function	This panel represents the 7-segment LED jumper exit. It is used to light a 7-segment LED if the input is enabled. This panel is assigned with the [7-segment LED jumper] processing panel. To use a 7-segment LED, the display type must be prespecified by specifying the properties of this panel. (The display of the [7-segment LED jumper] panel changes according to the specified display type.) Caution 7-segment LEDs of different display types cannot be used at the same time. Therefore, if the display type is changed during editing by specifying the properties of this panel, the [7-segment LED jumper] panel already assigned to the editing area will be displayed as by default and the properties must be respecified.
	Names of supported devices and boards	78K0/KE2, 78K0/KF2
	Default properties	- Assigned ports: P06, P05, P17, P16, P12, P11, P10, P25 to P22 - Display type: None (must be specified)  Property settings of [7-segment display] panel

(4) Processing panels

Processing panels can be assigned to the processing block area and include the following.

(a) [Common] tab







Whether the properties of the panels on the [Common] tab must be specified, depends on the type of processing.





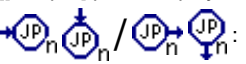

The properties of the panels assigned to the output block area must be specified, because their properties are not specified by default. (The properties of assigned panels marked with a  mark in the editing area must be specified.)







[\[Rotate\]](#) in the right-click menu is enabled depending on the panel type. Use this item when editing the panels.







[Remark] By selecting any panel and pressing [Alt] and an arrow key after assigning the panels to the editing area, another instance of the same panel can be pasted at the same time such that it faces the direction of the arrow key (except for panels for which the size is displayed in multiple stages).

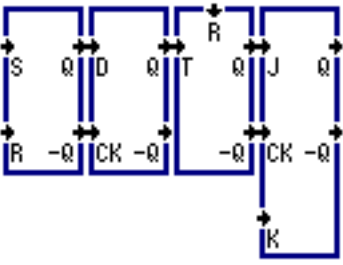





Table 6-7. Processing Panels







Panel	Description	
	Name	Wiring
	Function	This panel transmits on or off information from the upper left panel connected to the panel to the lower right panel. Multiple instances of this panel can be assigned to the processing area.
	Names of supported devices and boards	All products
	Properties	Not required to be specified
	Name	Jumper
	Function	This panel represents the input (left) or output (left) of a jumper. This panel transmits on or off information from the jumper input that has the identification number ("n" below) specified in the properties to the jumper output that has the same number. The [Rotate] menu is enabled for this panel. Caution Multiple instances of the same jumper output that have the same identification number can be specified. However, multiple instances of the same jumper input that have the same identification number cannot be specified. [[Jumper] panel displayed in the editing area]  : If identification number n is specified
	Names of supported devices and boards	All products
	Properties	- Identification number  Property settings of [Jumper] panel
	Name	NC
	Function	This panel is used when not connecting a panel. The [Rotate] menu is enabled for this panel.
	Names of supported devices and boards	All products
	Properties	Not required to be specified
	Name	Logic
	Function	This panel is used to perform an AND operation. The [Rotate] menu is enabled for this panel.
	Names of supported devices and boards	All products
	Properties	Not required to be specified





Panel	Description	
	Name	Logic
	Function	This panel is used to perform a NOT operation. The [Rotate] menu is enabled for this panel.
	Names of supported devices and boards	All products
	Properties	Not required to be specified
	Name	Logic
	Function	This panel is used to perform an OR operation. The [Rotate] menu is enabled for this panel.
	Names of supported devices and boards	All products
	Properties	Not required to be specified
	Name	Logic
	Function	This panel is used to perform an XOR operation. The [Rotate] menu is enabled for this panel.
	Names of supported devices and boards	All products
	Properties	Not required to be specified
	Name	Logic
	Function	This panel is used to always output an on (left) or off (right) signal. The [Rotate] menu is enabled for this panel.
	Names of supported devices and boards	All products
	Properties	Not required to be specified
	Name	Comparator
	Function	This panel is used to compare 4-bit or 8-bit values input from two sources, A and B. The comparison result is expressed by using three output signals, A > B, A < B, and A = B. If the input from A is greater than the input from B, the output signal ">" goes to the high level. If the input from A is less than the input from B, the output signal "<" goes to the high level. If the inputs from both A and B are equal, the output signal "=" goes to the high level.
	Names of supported devices and boards	78K0/Kx2, 78K0R/KE3-L, 78K0/KC2-L, TK-78K0R/KE3L, TK-78K0/KC2L
	Properties	- Number of bits to be compared  Property settings of [Comparator] panel

Panel	Description	
	Name	UART6 jumper output
	Function	<p>This panel represents the UART transmission jumper entrance. This panel is assigned with the [UART6 output] output panel. If 1 (on) or 0 (off) is input for the bit position that is the identification number of the jumper specified in the properties ("n" below), 1 or 0 is directly transmitted to the [UART6 output] panel in the output block area. [[UART6 jumper output] panel displayed in the editing area]</p>  : If identification number (bit position) n is specified Caution This panel is provided to secure compatibility with Applilet EZ PL V3.6 or earlier.
	Names of supported devices and boards	78K0S/KB1+, 78K0S/KA1+, 78K0/Kx2
	Properties	- Bit position  Property settings of [UART6 jumper output] panel
	Name	UART0 jumper output
	Function	<p>This panel represents the UART transmission jumper entrance. This panel is assigned with the [UART0 output] output panel. If 1 (on) or 0 (off) is input for the bit position that is the identification number of the jumper specified in the properties ("n" below), 1 or 0 is directly transmitted to the [UART0 output] panel in the output block area. [[UART0 jumper output] panel displayed in the editing area]</p>  : If identification number (bit position) n is specified Caution This panel is provided to secure compatibility with Applilet EZ PL V3.6 or earlier.
	Names of supported devices and boards	78K0/Kx2
	Properties	- Bit position  Property settings of [UART0 jumper output] panel

Panel	Description		
	Name	7-segment LED jumper	
	Function	<p>This panel represents the 7-segment LED jumper entrance. This panel is assigned with the [7-segment display] output panel. The display type of the 7-segment LED can be specified by prespecifying the properties of the [7-segment display] panel. The information output from this panel is directly transmitted to the [7-segment display] panel in the output block area.</p> <p>Caution Panels of different display types cannot be used at the same time. Therefore, if the display type is changed during editing by specifying the properties of the [7-segment display] panel, these panels, which are already assigned to the editing area, are displayed as by default and the properties must be respecified.</p> <p>The display of the panel changes as follows depending on the specified display type.</p>	
		Function	<p>Digit type Specify, in the properties, the digit or character displayed if an on signal is input. The character of the jumper entrance that has been enabled is displayed for the LED.</p> <p>Caution Caution must be exercised so that panels that have the same digit or character are not enabled at the same time.</p>
		Properties	<ul style="list-style-type: none"> - Displayed digit - Displayed value <p> Property settings of [7-segment LED jumper (digit type)] panel</p>
		Function	<p>Segment type Specify, in the properties, the digit or segment displayed if an on signal is input. Multiple segments can be specified by using one jumper.</p>
		Properties	<ul style="list-style-type: none"> - Displayed digit - Displayed segment <p> Property settings of [7-segment LED jumper (segment type)] panel</p>
		Function	<p>Bit type Specify, in the properties, the bit position of the binary data (8 or 16 bits) of the value to be displayed. Binary data is created assuming that the bit position of the enabled jumper input as 1, and that numeral is displayed for the LED.</p>
		Properties	<ul style="list-style-type: none"> - Bit position <p> Property settings of [7-segment LED jumper (bit type)] panel</p>
	Names of supported devices and boards	78K0/KE2, 78K0/KF2, TK-78K0R/KE3L, TK-78K0/KC2L	

























Panel	Description	
	Name	Flip-flop
	Function	<p>This panel operates as a flip-flop of the type specified in the properties. [[Flip-flop] panel displayed in the editing area]</p> 
	Names of supported devices and boards	All products
	Properties	- Operation type  Property settings of [Flip-flop] panel
	Name	Counter
	Function	<p>This counter is incremented every time the clock input is disabled. If the count value matches the value specified in the properties, the output is enabled.</p> <p>By specifying multiple values, the panel is stretched vertically (up to 15 stages) and multiple outputs can be processed.</p> <p>The initial value of the counter is 0. Input from a higher block is assumed to be a reset signal and the counter is reset to the initial value.</p> <ul style="list-style-type: none"> • Hold type: The counter stops at the maximum count value. • Cyclic type: The counter is reset at the maximum count value when a signal is input. <p>Caution Edit panels by assigning up to 10 counter panels, timer panels, and delay panels in total. If object code (*.hex) is automatically generated when using more than 10 panels, an error is output and compilation is aborted.</p>
	Names of supported devices and boards	All products
	Properties	- Operation type - Set value  Property settings of [Counter] panel
	Name	Binary counter
	Function	<p>This 4-bit binary counter is incremented every time clock input C0 changes from 0 to 1 while clock input C1 is 1 or clock input C1 changes from 1 to 0 while clock input C0 is 0.</p> <p>If the master reset input MR is set to 1, all outputs will be 0.</p> <ul style="list-style-type: none"> • BCD mode: The counter is incremented from 0 to 9. The counter returns to 0 after being incremented up to 9. • HEX mode: The counter is incremented from 0 to 15 (F in hexadecimal). The counter returns to 0 after being incremented up to F.
	Names of supported devices and boards	All products
	Properties	- Operation type  Property settings of [Binary counter] panel

Panel	Description	
	Name	Timer
	Function	<p><u>Hold type or toggle type</u></p> <p>The output is enabled when the time specified in the properties elapses after the input is enabled.</p> <ul style="list-style-type: none"> • Hold type: The on status is retained after the output is enabled. • Toggle type: On and off alternate in the specified time cycle after the output is enabled. <p><u>One-shot type or one-shot (retriggerable) type</u></p> <p>The output is enabled when the input is enabled and the output is disabled after the specified time elapses.</p> <ul style="list-style-type: none"> • Retriggerable type: The timer restarts when the input is enabled again while the output enabled. <p>Caution Edit panels by assigning up to 10 counter panels, timer panels, and delay panels in total. If object code (*.hex) is automatically generated when using more than 10 panels, an error is output and compilation is aborted.</p>
	Names of supported devices and boards	All products
	Properties	- Operation type - Time  Property settings of [Timer] panel
	Name	Delay
	Function	<p>When the time specified in the properties elapses after the input signal changes, the same signal as that previously input is output.</p> <p>If the input signal changes before a signal is output, the time is measured again from that point. Therefore, if the input signal is inverted within the specified time, the output signal does not change.</p> <p>Caution Edit panels by assigning up to 10 counter panels, timer panels, and delay panels in total. If object code (*.hex) is automatically generated when using more than 10 panels, an error is output and compilation is aborted.</p>
	Names of supported devices and boards	All products
	Properties	- Time  Property settings of [Delay] panel
	Name	Clock
	Function	<p>This panel has no input pins and is used to output the clock of the specified time.</p> <p>The function of this panel is equivalent to that of the [Timer] panel of the toggle type.</p>
	Names of supported devices and boards	All products
	Properties	- Pulse width  Property settings of [Clock] panel

Panel	Description	
	Name	Stepping motor
	Function	<p>This panel outputs a signal for controlling a four-stage stepping-motor. The size of the panel to be assigned to the editing area is four stages (vertical). By inputting information from a higher block, the stepping motor is rotated (on) or stopped (off). By inputting information from the left block, a signal for processing forward rotation (on) or reverse rotation (off) is output.</p> <p>Caution Edit this panel by assigning only one panel. If object code (*.hex) is automatically generated when assigning multiple panels, an error is output and compilation is aborted.</p>
	Names of supported devices and boards	78K0S/Kx1+
	Properties	<ul style="list-style-type: none"> - Rotation speed - Excitation method <p> Property settings of [Stepping motor] panel</p>
	Name	Reset
	Function	<p>This panel is used to reset the system by using the watchdog timer.</p> <p>Caution Settings must be specified in the Watchdog Timer Setting dialog box before using this panel.</p>
	Names of supported devices and boards	All products
	Properties	<ul style="list-style-type: none"> - Valid input value <p> Property settings of [Reset] panel</p>

(b) [74 Series] tab

The panels on the [74 Series] tab operate similarly to a 74HCxx logic IC.

Panel	Function	Panel	Function
	2-input NAND		2-input NOR
	3-input NAND		3-input AND
	4-input NAND		4-input AND
	3-input NOR		8-input NAND
	2/3-input AND-OR-NOT		4-bit bistable latch
	J-K FF with clear, preset and clock		13-input NAND
	3-to-8 line decoder		8-to-3 priority line encoder
	4-channel multiplexer		8-bit parallel-in/serial-out shift register
	9-bit parity generator		4-bit binary full adder
	4-input NOR		4-input OR
	3-input OR		8-input OR/NOR
	BCD-to-7-segment latch		2-input XNOR

Editing panels

(1) Assigning panels from the pallet

[Input panels](#), [Processing panels](#), and [Output panels](#) can be assigned to the editing area in the following two ways.

- (a) Left-clicking a panel on the pallet, moving the mouse cursor to the location in the editing area to which to assign the panel, and then left-clicking again
- (b) Left-clicking a panel on the pallet, moving the mouse cursor to the location in the editing area to which to assign the panel, and then releasing the left mouse button (dragging and dropping)

[Caution 1] When using method (a), the panel selected on the pallet remains selected even after it is assigned. Therefore, repeatedly click the left mouse button in the editing area to assign multiple instances of that panel. To deselect the panel, left-click the panel again or left-click different panel.

[Caution 2] Assign panels so that the ROM size does not exceed the size of the flash ROM provided in the product. (Watch the [Status bar](#) when assigning panels [Note].)

[Note] The estimated ROM size differs from the result of actual compilation.

[Caution 3] When editing, assign no more than ten instances of the processing panels below, total. If object code (*.hex) is automatically generated when using more than 10 panels, an error is output and compilation is aborted.



[Caution 4] If an attempt is made to assign a panel to a location where panels cannot be assigned, the operation is ignored.

If an attempt is made to assign a panel to a location where a panel whose properties are already specified is already assigned, a message to confirm whether to overwrite the existing panel is displayed. The existing panel is overwritten only if [OK] is clicked.

(2) Repeatedly assigning panels

Multiple instances of the same panel can be assigned by clicking a panel and dragging it into the editing area.

(3) Selecting multiple panels

Multiple panels can be selected by holding down [Ctrl] while dragging a panel in the editing area. (The selected range is indicated by a red frame.)

However, panels of different types (input, processing, and output panels) cannot be selected at the same time. Panels that have multiple stages cannot be selected unless all stages are included in the selected range.

(4) Copying, cutting, and pasting panels

The following operations can be performed in the editing area.

(a) Copying

To copy a panel or multiple panels in the selected range to the internal buffer, select a panel or panels, click the [Edit] menu, and then click [Copy] in the right-click menu, or click .

(b) Cutting

To copy a panel or panels in the selected range to the internal buffer and then delete them from the editing area, select a panel or panels, click the [Edit] menu, and then click [Cut] in the right-click menu, or click

**(c) Pasting**

To paste the panel information in the internal buffer to the selected location, click the [Edit] menu, and then click [Paste] in the right-click menu, or click



If multiple panels have been copied to the internal buffer, paste the panel information to the location to the left and above the desired location. However, if the selected range is smaller than the copied range, the panel information cannot be pasted.

If a panel already exists at the desired location, the following message to select which processing to use is displayed.

Figure 6-3. Confirmation Message Displayed if a Panel Exists at the Desired Location



Select the processing from the following.

[Yes]: Replace all pasted panels. (Delete all specified properties.)

[No]: Paste the panel information only to locations where panels have not been pasted.

[Cancel]: Do not paste the panel information.

(5) Moving panels

Panels assigned to the editing area can be moved by dragging and dropping them. If panels whose properties are specified already exist at the location to which you want to move the panels, a message asking whether to overwrite the existing panels is displayed. The panels are moved only if [OK] is clicked.

(6) Deleting panels

Panels assigned to the editing area can be deleted by selecting the panels to delete, and then taking one of the actions below.

However, if a panel whose properties are specified is included in the panels to delete, a message asking whether to delete the panel is displayed. The panel is deleted only if [OK] is clicked.

- Clicking [Delete] in the right-click menu
- Dragging and dropping the panels outside the editing area
- Pressing the [Delete] key
- Clicking the [Edit] menu, and then [Delete]

(7) Rotating panels

The I/O direction of the processing panels below can be changed by selecting [Rotate] in the right-click menu in the editing area. The I/O direction is switched each time [Rotate] is selected.



(8) Shifting panels vertically

All panels assigned to the editing area can be shifted to the row above or below by clicking the [Edit] menu, [Move All Panels], and then [To Upper] or [To Lower].

If this operation is performed, the panels assigned to the top or bottom row is deleted.

(9) Shifting panels horizontally

The processing panels assigned to the editing area can be shifted to the column to the right or left by clicking the [Edit] menu, [Move All Panels], and then [To Right] or [To Left]. (Input and output panels are not shifted.)

If this operation is performed, the processing panels assigned to the rightmost or leftmost column is deleted.

(10) Specifying properties

The properties of the panels assigned to the editing area during editing must be specified. (Properties do not have to be specified for some panels.)

Specify or change the properties in the [Property Settings dialog box](#) opened by performing one of the operations below. (For details about the items to specify, see the description of the relevant panel in the section describing the [Property Settings dialog box](#).)

- Click the target panel, the [Edit] menu, and then [Show Panel's Property].
- Click the target panel and then [Property setting] in the right-click menu.
- Double-click the target panel.





However, if the target panel is double-clicked while another panel is selected, the target panel will be overwritten by the selected panel. Therefore, make sure to deselect the selected panel before double-clicking the target panel.

(11) Changing the panel size by specifying the properties

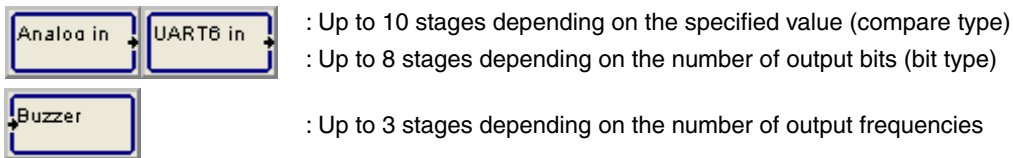
By specifying the properties, the following panels are stretched vertically and become capable of handling multiple input or output signals by using one panel.

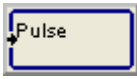
However, if panels are already assigned to the blocks to be occupied by changing the size of a panel, the specified properties will be invalid and the panel size will not change. Therefore, the required number of vacant blocks must be secured in advance.

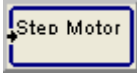
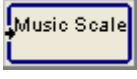

		: 3 or 5 stages, or up to 15 stages depending on the number of duty factors
		: Fixed to 2 stages for the Enable and Dir input signals
		: Up to 37 stages depending on the musical output range
		: Up to 3 stages depending on the operation type
		: Up to 15 stages depending on the counter setting

(12) Displaying information about the corresponding jumpers

If **Jumper** panels are used in the processing area, supplementary lines that indicate the correspondence among the jumper panels and other panels according to the identification numbers specified in the jumper panel properties can be temporarily displayed by clicking [Jumper Relation] in the right-click menu. (Nothing is displayed if corresponding jumper panels do not exist or the identification numbers are not specified in the jumper panel properties.)

The supplementary lines are deleted by clicking any panel in the editing area.

Figure 6-4. Example of the Displayed Correspondence of Jumpers

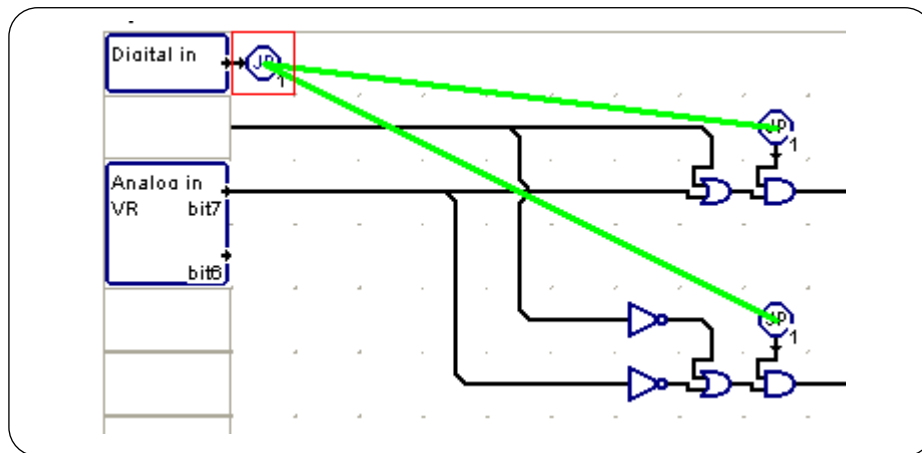

(13) Clearing all panels

All panels assigned to the editing area can be cleared (deleted) by clicking the [File] menu and then [New], or by clicking  on the toolbar.

If panels are cleared during editing, a confirmation message that the edited contents will be deleted is displayed. All panels are cleared only if [OK] is clicked.

(14) Undoing

An operation to paste panels, move panels, delete panels, shift panels, or specify or change the properties of panels can be reversed once by clicking the [Edit] menu, and then [Undo].

However, an operation performed by clicking the [File] menu and then [New], or by clicking  on the toolbar, cannot be reversed.

Saving and reading data

(1) Saving data

The current status of editing (the types, locations, and properties of all panels in the editing area) can be saved to a panel location file (*.loc) by clicking the [File] menu and then [Save as...] or [Save], or by clicking  on the [Toolbar](#).

(2) Reading data

An existing panel location file (*.loc) can be read to reproduce the previous status (the types, locations, and properties of all panels in the editing area) by clicking the [File] menu and then [Open...], or by clicking  on the [Toolbar](#).

During editing, a confirmation message is displayed, and the panel location file (*.loc) is read to reproduce the previous status only if [OK] is clicked.

Automatically generating object code and writing to flash memory

To perform compilation that automatically generates object code (*.hex) that handles the current panel assignment as one sequence, click the [Run] menu and then [Build & Write], or click  on the [Toolbar](#).

If compilation ends normally, the flash memory provided in the 78K0/Kx2, 78K0S/Kx1+, 78K0R/KE3-L, or 78K0/KC2-L is written to.

The operation to write to the flash memory differs depending on the target CPU settings. If a supported evaluation board is used, writing to the flash memory is started by clicking [OK] after compilation ends, because the flash memory programmer provided in Applilet EZ PL is used. If a device is selected in the target CPU settings, use the software GUI for the flash memory programmer to be used to write to the flash memory after compilation ends.

The object code (*.hex) to be written to the flash memory is automatically generated in the folder in which the target panel location file is saved.

During compilation or writing to the flash memory, the following dialog box automatically opens and the execution status is displayed.

If an error occurs at this time, a description of the error is displayed and compilation is aborted. (For details about errors, see [CHAPTER 7 ERROR MESSAGES](#).)

Figure 6-5. Example of the Execution Status Displayed During Compilation or Writing to the Flash Memory

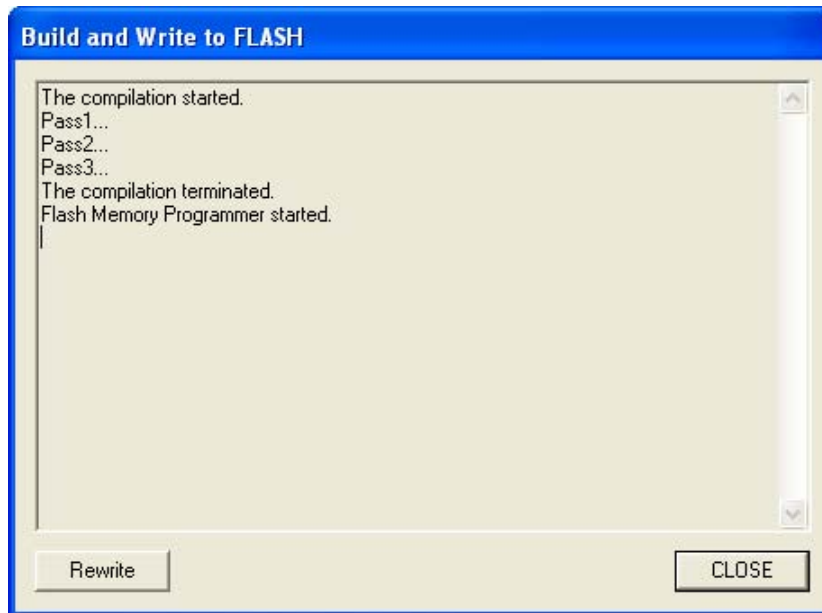

[Caution 1] When editing panels, object code (*.hex) cannot be generated until the panel location file (*.loc) is saved.

During compilation, Applilet EZ PL automatically generates object code (*.hex) by saving the information about the current panel assignment to a temporary panel location file (*.loc) and then referencing that file.

Therefore, if compilation is executed without saving the information about the current panel assignment after editing panels, the saved panel location file (*.loc) and generated object code (*.hex) might not match.

[Caution 2] If any of the following conditions are not satisfied, Applilet EZ PL will output an error when automatically generating object code (*.hex) and abort compilation:

- The required properties of all assigned panels are specified. (The  mark indicates that the properties of the marked panel have not been fully specified.)
- All assigned panels are wired. (Delete the panels not to be used from the editing area.)
- No ports are specified more than once in the properties of I/O panels. (This can be checked in the [Port Setting dialog box](#).)
- The ROM size does not exceed the size of the flash ROM provided in the product. (This can be checked in the [Status bar](#) [Note].)
- No more than 10 instances of the [Counter], [Timer], and [Delay] panels are assigned in total (only for the 78K0S/Kx1+).



[Note] The estimated ROM size differs from the result of actual compilation.

[Caution 3] If using a supported evaluation board, turn on the power of the evaluation board and specify a mode in which data can be written to the flash memory before writing to the flash memory. When writing to the flash memory ends, switch the mode to normal operation mode, and then press the reset switch to operate the microcontroller.

[Caution 4] Make sure that the evaluation board and host are connected via the provided USB cable. (See [3.2.1 Installing software.](#))

Right-click menu





The following menu items are displayed by right-clicking on a panel assigned to the editing area.

[Rotate]	<p>This changes the I/O direction of the target panel. The I/O direction is switched each time this menu item is selected.</p> <p>This menu item cannot be selected for some panel types.</p> <p>The function of this menu item is equivalent to that performed by clicking the [Edit] menu and then [Rotate].</p>
[Cut]	<p>This copies one or more panels in the currently selected range to the internal buffer, and then deletes the panels from the editing area.</p> <p>The function of this menu item is equivalent to that performed by clicking the [Edit] menu and then [Cut], or by clicking  on the toolbar.</p>
[Copy]	<p>This copies one or more panels in the currently selected range to the internal buffer.</p> <p>The function of this menu item is equivalent to that performed by clicking the [Edit] menu and then [Copy], or by clicking  on the toolbar.</p>
[Paste]	<p>This pastes the panels copied to the internal buffer to the selected location.</p> <p>If multiple panels have been copied to the internal buffer, the panels are pasted to the left and above the desired location. However, if the selected range is smaller than the copied range, the panel information cannot be pasted.</p> <p>If a panel already exists at the desired location, a message to select which processing to use is displayed. (See (4) Copying, cutting, and pasting panels.)</p> <p>This menu item cannot be selected if no information exists in the internal buffer.</p> <p>The function of this menu item is equivalent to that performed by clicking the [Edit] menu and then [Paste], or by clicking  on the toolbar.</p>
[Delete]	<p>This deletes the currently selected panels from the editing area.</p> <p>If the properties of the panels to be deleted are specified, the properties are also deleted.</p> <p>The function of this menu item is equivalent to that performed by clicking the [Edit] menu and then [Delete].</p>





[Jumper Relation]	<p>This temporarily displays supplementary lines that indicate the correspondence among the currently selected jumper panels and other panels according to the identification numbers specified in the jumper panel properties. Nothing is displayed if the corresponding jumper panels do not exist or the identification numbers are not specified in the jumper panel properties.</p> <p>The supplementary lines are deleted by clicking any panel in the editing area.</p> <p>This menu item cannot be selected if a panel other than a jumper panel is selected.</p>
[Property setting...]	<p>This opens the Property Settings dialog box for the target panel.</p> <p>The function of this menu item is equivalent to that performed by clicking the [Edit] menu and then [Show Panel's Property].</p>
[Description]	<p>This displays details about the target panel in the help area.</p> <p>The function of this menu item is equivalent to that performed by clicking the [Help] menu and then [Panel Description].</p>

Menu bar

(1) [File] menu

[New]	<p>This starts a new edit.</p> <p>During editing, a message indicating that the edited contents are erased will be displayed. A new editing window is displayed only if [OK] is clicked.</p> <p>The function of this menu item is equivalent to that performed by clicking  on the toolbar.</p>
[Open...]	<p>This reads an existing panel location file (*.loc) and reproduces the previous status (the types, locations, and properties of all panels in the editing area).</p> <p>The function of this menu item is equivalent to that performed by clicking  on the toolbar.</p>
[Save]	<p>This saves the current status (the types, locations, and properties of all panels in the editing area) to a panel location file (*.loc).</p> <p>The function of this menu item is equivalent to that performed by clicking  on the toolbar.</p>
[Save as...]	<p>This saves the current status (the types, locations, and properties of all panels in the editing area) to a new panel location file (*.loc).</p>
[Print...]	<p>This prints a screenshot of the current panel assignment and information about the properties of each panel (the assigned location, panel name, and property values).</p> <p>The function of this menu item is equivalent to that performed by clicking  on the toolbar.</p>
[Preview]	<p>This displays a print preview of a screenshot of the current panel assignment and information about the properties of each panel (the assigned location, panel name, and property values).</p>
[Print Setup...]	<p>This specifies the printer to be used and the printer options.</p>
[Recently Used Files]	<p>This displays up to four files that have recently been used.</p>
[Exit]	<p>This closes Applilet EZ PL.</p>



(2) [Edit] menu

[Undo]	<p>This reverses an operation such as pasting, moving, deleting, shifting, or specifying or changing the properties of a panel to the original status only once.</p> <p>However, the operation performed by clicking the [File] menu and then [New], or by clicking  on the toolbar cannot be reversed.</p> <p>The function of this menu item is equivalent to that performed by clicking  on the toolbar.</p>
[Cut]	<p>This copies one or more panels in the currently selected range to the internal buffer, and then deletes the panels from the editing area.</p> <p>The function of this menu item is equivalent to that performed by clicking [Cut] in the right-click menu, or by clicking  on the toolbar.</p>
[Copy]	<p>This copies one or more panels in the currently selected range to the internal buffer.</p> <p>The function of this menu item is equivalent to that performed by clicking [Copy] in the right-click menu, or by clicking  on the toolbar.</p>
[Paste]	<p>This pastes the panels copied to the internal buffer to the selected location.</p> <p>If multiple panels have been copied to the internal buffer, the panels are pasted to the left and above the desired location. However, if the selected range is smaller than the copied range, an error message indicating that the panel information cannot be pasted is displayed.</p> <p>If a panel already exists at the desired location, a message to select which processing to use is displayed. (See (4) Copying, cutting, and pasting panels.)</p> <p>This menu item cannot be selected if no information exists in the internal buffer.</p> <p>The function of this menu item is equivalent to that performed by clicking [Paste] in the right-click menu, or by clicking  on the toolbar.</p>
[Delete]	<p>This deletes the currently selected panels from the editing area.</p> <p>If the properties of the panels to be deleted are specified, the properties are also deleted.</p> <p>The function of this menu item is equivalent to that performed by clicking [Delete] in the right-click menu.</p>
[Rotate]	<p>This changes the I/O direction of the target panel. The I/O direction is switched each time this menu item is selected.</p> <p>This menu item cannot be selected for some panel types.</p> <p>The function of this menu item is equivalent to that performed by clicking [Rotate] in the right-click menu.</p>
[Move All Panels]	This displays the next cascade menu.
[To Upper]	This shifts all panels assigned to the editing area to the row above, deleting panels assigned to the top row.
[To Lower]	This shifts all panels assigned to the editing area to the row below, deleting panels assigned to the bottom row.
[To Right]	This shifts the processing panels assigned to the editing area to the row to the right (I/O panels are not shifted), deleting processing panels assigned to the rightmost row.
[To Left]	This shifts the processing panels assigned to the editing area to the row to the left (I/O panels are not shifted), deleting processing panels assigned to the leftmost row.
[Show Panel's Property]	<p>This opens the Property Settings dialog box for the currently selected panel.</p> <p>The function of this menu item is equivalent to that performed by clicking [Property setting] in the right-click menu.</p>

(3) [View] menu

[Assigned ports...]	This opens the Port Setting dialog box that displays a list of the I/O ports currently specified in the property settings.
[Output Window]	Build, simulation, and help areas are displayed by selecting this item (displayed by default).
[Toolbar]	Toolbar is displayed by selecting this item (displayed by default).

(4) [Run] menu

[Build & Write]	<p>This performs compilation that automatically generates object code (*.hex) that handles the current panel assignment as a processing sequence.</p> <p>If compilation ends normally, the flash memory provided in the 78K0/Kx2, 78K0S/Kx1+, 78K0R/KE3-L, or 78K0/KC2-L can be written successively.</p> <p>The object code (*.hex) is automatically generated in the same folder as the panel location file (*.loc). Therefore, when editing panels, this menu item cannot be used until data is saved.</p> <p>The function of this menu item is equivalent to that performed by clicking  on the toolbar.</p>
[Start simulation]	<p>This can be used to simulate a created program by using Applilet EZ PL before compilation.</p> <p>[Stop simulation] is displayed during simulation.</p> <p>The function of this menu item is equivalent to that performed by clicking  on the toolbar.</p>

[Caution] If any of the following conditions are not satisfied, Applilet EZ PL will output an error when automatically generating object code (*.hex) and abort compilation:

- The required properties of all assigned panels are specified. (The  mark indicates that the properties of the marked panel have not been fully specified.)
- All assigned panels are wired. (Delete the panels not to be used from the editing area.)
- No ports are specified more than once in the properties of I/O panels. (This can be checked in the [Port Setting dialog box](#).)
- The ROM size does not exceed the size of the flash ROM provided in the product. (This can be checked in the [Status bar](#) [Note].)
- No more than 10 instances of the [Counter], [Timer], and [Delay] panels are assigned in total (only for the 78K0S/Kx1+).

[Note] The estimated ROM size differs from the result of actual compilation.

(5) [Settings] menu

[Target CPU...]	This opens the Target CPU Settings dialog box used for selecting the device or board and system clock source to be used.
[CPU Function...]	This displays the next cascade menu.
[Watchdog timer...]	This selects the use of the watchdog timer and opens the Watchdog Timer Setting dialog box in which to specify settings.
[UART0...]	This opens the UART0 Settings dialog box in which to specify the properties of the UART0 I/Os.
[UART1...]	This opens the UART1 Settings dialog box in which to specify the properties of the UART1 I/Os.
[UART6...]	This opens the UART6 Settings dialog box in which to specify the properties of the UART6 I/Os.
[FLASH memory programmer...]	This opens the Flash Memory Programmer Settings dialog box in which to specify the COM port used for writing to the flash memory provided in the 78K0/Kx2, 78K0S/Kx1+, 78K0R/KE3-L, or 78K0/KC2-L.
[Folders...]	This opens the Saved Data Folder dialog box in which to specify where to save data.







(6) [Help] menu

[Show User's Manual...]	This displays the Applilet EZ PL User's Manual.
[Panel Description]	This displays details about the target panel in the help area.
[Version...]	This displays the Applilet EZ PL version in the order of the "Product Name", "Version Number", and "Copyright Year".

Toolbar

The following buttons on the toolbar can be used to execute frequently used menu items just by clicking once.

Table 6-8. Functions of Toolbar Buttons

Button	Function
 New	The function of this button is equivalent to that performed by clicking the [File] menu and then [New].
 Open	The function of this button is equivalent to that performed by clicking the [File] menu and then [Open...].
 Save	The function of this button is equivalent to that performed by clicking the [File] menu and then [Save].
 Print	The function of this button is equivalent to that performed by clicking the [File] menu and then [Print...].
 View	The function of this button is equivalent to that performed by clicking the [File] menu and then [Preview].
 Cut	The function of this button is equivalent to that performed by clicking the [Edit] menu and then [Cut], or by clicking [Cut] in the right-click menu.
 Copy	The function of this button is equivalent to that performed by clicking the [Edit] menu and then [Copy], or by clicking [Copy] in the right-click menu.
 Paste	The function of this button is equivalent to that performed by clicking the [Edit] menu and then [Paste], or by clicking [Paste] in the right-click menu.
 Undo	The function of this button is equivalent to that performed by clicking the [Edit] menu and then [Undo].
 Start	The function of this button is equivalent to that performed by clicking the [Run] menu and then [Start simulation] when simulation is stopped.
 Stop	The function of this button is equivalent to that performed by clicking the [Run] menu and then [Stop simulation] during simulation.
 Build	The function of this button is equivalent to that performed by clicking the [Run] menu and then [Build & Write].

Status bar

The following information is displayed on the status bar.

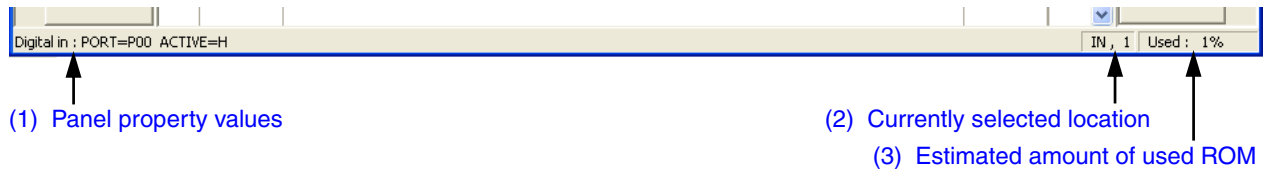
Figure 6-6. Status Bar Example**(1) Panel property values**

The name and property values of the panel on which the mouse cursor is currently placed in the editing area are displayed. However, these are not displayed for a panel whose properties cannot be specified.

(2) Currently selected location

The location currently selected in the editing area is displayed in this field as coordinates.

The coordinates represent the values on the horizontal and vertical axes, with the top-left corner of each area as the origin.

However, for the input and output block areas, the values on the horizontal axis will be fixed to "IN" and "OUT", respectively.

[Example] Input block area: "IN, yy"

Output block area: "OUT, yy"

(3) Estimated amount of used ROM

The estimated amount of used ROM is displayed in this field.

The value is rounded to the nearest KB. (If the used amount is estimated as 0.2 KB, 1 KB is displayed.)

If object code (*.hex) is automatically generated, the estimated value is corrected and then displayed in the build area. The estimated amount is only a benchmark. For the actually generated size, see the value displayed in the execution status display window when object code is automatically generated or data is written to flash memory, or see the generated map file.

Property Settings dialog box

This dialog box is used to specify the properties of the panels to be assigned to the editing area in the [Main window](#). The appearance of the dialog box differs for each panel, because the specifiable properties differ for each panel type.

This dialog box is opened by performing one of the following operations in the editing area in the [Main window](#).

- Click the target panel, the [Edit] menu, and then [Show Panel's Property].
- Double-click the target panel.
- Click the target panel and then [Property setting] in the right-click menu.

Figure 6-7. Example of the Property Settings Dialog Box (for the [Push Button] Panel)

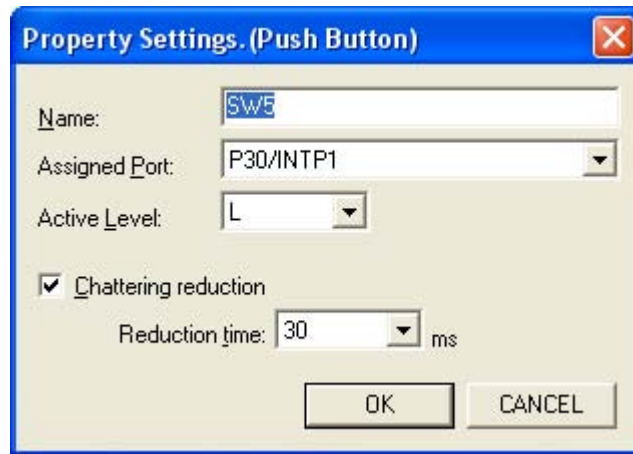

The following items are described below:

- [Function buttons](#)
- [Details of the Property Settings dialog boxes](#)



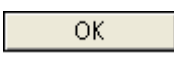
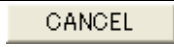

Function buttons

Button	Function
	Applies the settings as properties of the selected panel and closes the dialog box. However, this button cannot be selected if the required items are not specified.
	Does not apply the settings and closes the dialog box.



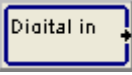



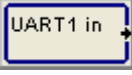
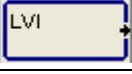
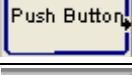
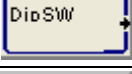
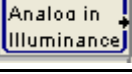

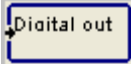
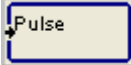
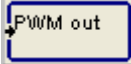
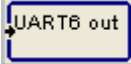
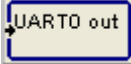
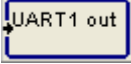
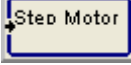
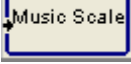
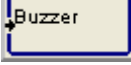
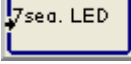
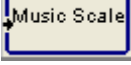
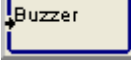
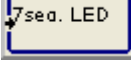





Details of the Property Settings dialog boxes

Details of the dialog boxes for specifying the properties for input, output, and processing panels are provided below. The correspondence among each panel and the corresponding Property Settings dialog box is shown below.

Table 6-9. Property Settings Dialog Boxes

Panel Type	Tab Name	Panel	How to Specify the Properties
Input panels	[Common]		Property settings of [Digital input] panel
			Property settings of [Analog input] panel
			Property settings of [UART6 input] panel
			Property settings of [UART0 input] panel
			Property settings of [UART1 input] panel
			Property settings of [LVI] panel
	[TK-78K0R/KE3L I/Os] and [TK-78K0/KC2L I/Os]		Property settings of [Push button] panel
			Property settings of [DIP switch] panel
			Property settings of [Analog input (illuminance)] panel

Panel Type	Tab Name	Panel	How to Specify the Properties
Output panels	[Common]		Property settings of [Digital output] panel
			Property settings of [Simple PWM] panel
			Property settings of [PWM output] panel
			Property settings of [UART6 output] panel
			Property settings of [UART0 output] panel
			Property settings of [UART1 output] panel
			Property settings of [Step motor] panel
			Property settings of [Musical-scale output] panel
Output panels	[TK-78K0R/KE3L I/Os] and [TK-78K0/KC2L I/Os]		Property settings of [Buzzer] panel
			Property settings of [7-segment display] panel
			Property settings of [Musical-scale output] panel
Output panels	[Other I/Os]		Property settings of [Buzzer] panel
			Property settings of [7-segment display] panel

Panel Type	Tab Name	Panel	How to Specify the Properties
Processing panels	-		Property settings of [Jumper] panel
	-		Property settings of [Comparator] panel
	-		Property settings of [UART6 jumper output] panel [Note]
	-		Property settings of [UART0 jumper output] panel [Note]
	-		Property settings of [7-segment LED jumper (digit type)] panel
	-		Property settings of [7-segment LED jumper (segment type)] panel
	-		Property settings of [7-segment LED jumper (bit type)] panel
	-		Property settings of [Flip-flop] panel
	-		Property settings of [Counter] panel
	-		Property settings of [Binary counter] panel
	-		Property settings of [Timer] panel
	-		Property settings of [Delay] panel
	-		Property settings of [Clock] panel
	-		Property settings of [Stepping motor] panel
-		Property settings of [Reset] panel	

[Note] This panel is provided to secure compatibility with Applilet EZ PL V3.6 or earlier.

The property settings for Applilet EZ PL are described in the format below. (How to specify the properties in the property settings of [digital input] panel is shown below as an example.)

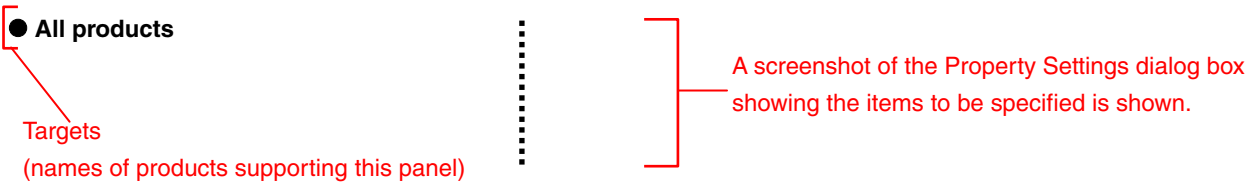



Property settings of [Digital input] panel

Input panel

- All products

Figure 6-8. Property Settings Dialog Box (for the [Digital Input] Panel)

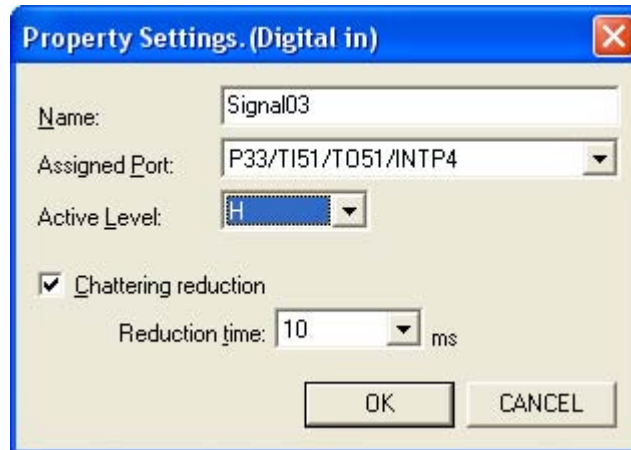
**(1) Name(N):**

Specify the name to display on the panel (second stage). (The name is not specified by default.)
This item can be omitted.

(2) Assigned Port(P):

Select the port to assign as the input pin from the drop-down list.
Make sure not to select a port that was already assigned by specifying the properties of another panel.

(3) Active Level(L):

Select H (high) or L (low) as the active level from the drop-down list. (H is selected by default.)

(4) Chattering reduction

Specify whether to eliminate chattering.

If the checkbox is selected, the time for eliminating chattering can be selected from 10, 20, 30, 40, 50, 60, 70, 80, 90, and 100 ms (not selected by default).



Property settings of [Analog input] panel

Input panel

- μ PD78F92xx (from among the 78K0S/Kx1+ products), 78K0/Kx2, 78K0R/KE3-L, 78K0/KC2-L, TK-78K0R/KE3L, and TK-78K0/KC2L

Figure 6-9. Property Settings Dialog Box (for the [Analog Input] Panel)

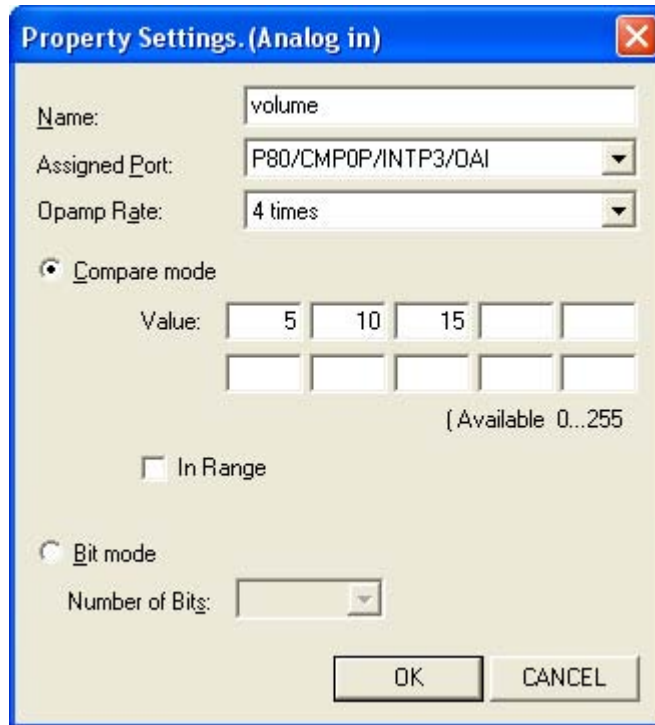
**(1) Name(N):**

Specify the name to display on the panel (second stage). (The name is not specified by default.)
This item can be omitted.

(2) Assigned Port(P):

Select the port to assign as the input pin from the drop-down list.
Make sure not to select a port that was already assigned by specifying the properties of another panel.

(3) Opamp Rate(A):

Multiplication by 4, 6, 8, 10, or 12 can be selected if P80/CMP0P/INTP3/OAI is selected as the assigned port for the 78K0R/KE3-L or TK-78K0R/KE3L.

Multiplication by 4, 8, 16, or 32 can be selected if P21/ANI1/AMP0OUT/PGAIN is selected as the assigned port for the 78K0/KC2-L or TK-78K0/KC2L.

(4) Selecting the type

Select either type by using the option buttons, and then specify the required values (not specified by default).

(a) Compare mode(C): Value:

If the A/D converted values are at least these specified values, output is enabled.

However, if the "In Range" checkbox is selected, output is enabled if A/D converted values are in the range of the specified values.

If multiple values are specified, the panel is stretched vertically (up to 10 stages) according to the specified values and the output of each specified value is passed to the processing block.

Up to 10 values in the range from 0 to 255 can be specified. (Values outside the range and identical values are ignored.)

(b) Bit mode(B): Number of Bits:

Each bit of the A/D converted values is enabled and output if the number of output bits is 1. The panel is stretched vertically (up to 8 stages) according to the specified number of output bits and the output of each bit is passed to the processing block.

From the drop-down list, select how many of the higher bits (1 to 8) to output.

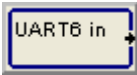

Property settings of [UART6 input] panel

Input panel

- 78K0S/KB1+, 78K0S/KA1+, 78K0/Kx2, 78K0/KC2-L, and TK-78K0/KC2L

Figure 6-10. Property Settings Dialog Box (for the [UART6 Input] Panel)

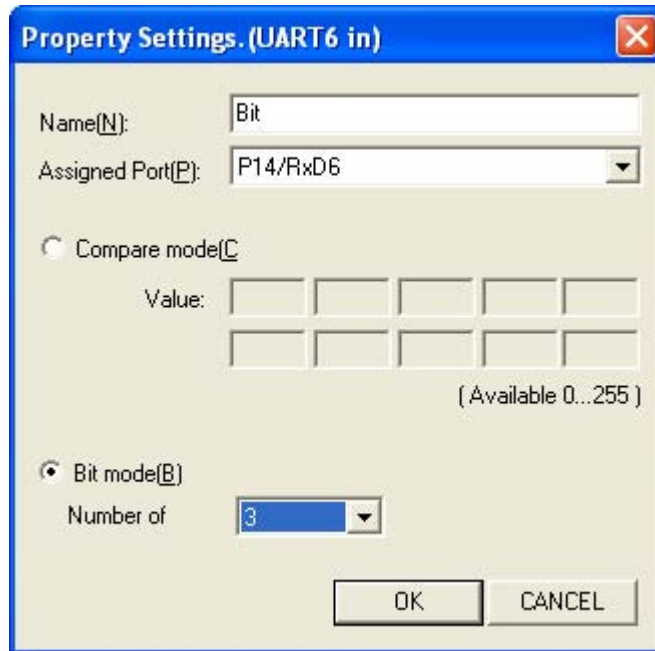
**(1) Name(N):**

Specify the name to display on the panel (second stage). (The name is not specified by default.)
This item can be omitted.

(2) Assigned Port(P):

The RxD6 pin is fixed as the input pin (and cannot be changed).

(3) Selecting the types

Select either type by using the option buttons, and then specify the required values (not specified by default).

(a) Compare mode(C): Value:

If the received data matches the specified values, output is enabled. If multiple values are specified, the panel is stretched vertically (up to 10 stages) according to the specified values and the output of each specified value is passed to the processing block.

Up to 10 values in the range from 0 to 255 can be specified. (Values outside the range and identical values are ignored.)

(b) Bit mode(B): Number of:

Each bit of received data is enabled and output if the number of output bits is 1. The panel is stretched vertically (up to 8 stages) according to the specified number of output bits and the output of each bit is passed to the processing block.

From the drop-down list, select how many of the higher bits (1 to 8) to output.

[Remark] Check the communication parameters in the [UART6 Settings dialog box](#).



Property settings of [UART0 input] panel

Input panel

- 78K0/Kx2, 78K0R/KE3-L, and TK-78K0R/KE3L

Figure 6-11. Property Settings Dialog Box (for the [UART0 Input] Panel)

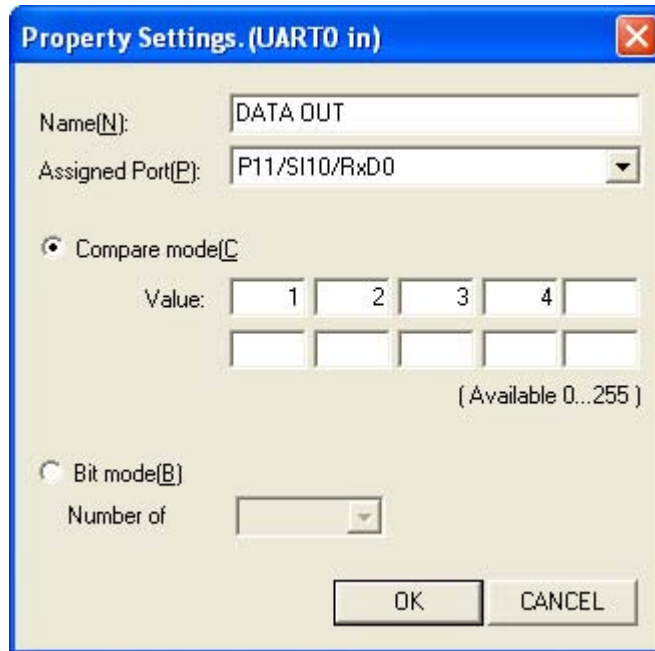
**(1) Name(N):**

Specify the name to display on the panel (second stage). (The name is not specified by default.)
This item can be omitted.

(2) Assigned Port(P):

The RxD0 pin is fixed as the input pin (and cannot be changed).

(3) Selecting the type

Select either type by using the option buttons, and then specify the required values (not specified by default).

(a) Compare mode(C): Value:

If the received data matches the specified values, output is enabled. If multiple values are specified, the panel is stretched vertically (up to 10 stages) according to the specified values and the output of each specified value is passed to the processing block.

Up to 10 values in the range from 0 to 255 can be specified. (Values outside the range and identical values are ignored.)

(b) Bit mode(B): Number of:

Each bit of received data is enabled and output if the number of output bits is 1. The panel is stretched vertically (up to 8 stages) according to the specified number of output bits and the output of each bit is passed to the processing block.

From the drop-down list, select how many of the higher bits (1 to 8) to output.

[Remark] Check the communication parameters in the [UART0 Settings dialog box](#).

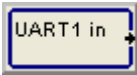

Property settings of [UART1 input] panel

Input panel

● 78K0R/KE3-L and TK-78K0R/KE3L

Figure 6-12. Property Settings Dialog Box (for the [UART1 Input] Panel)

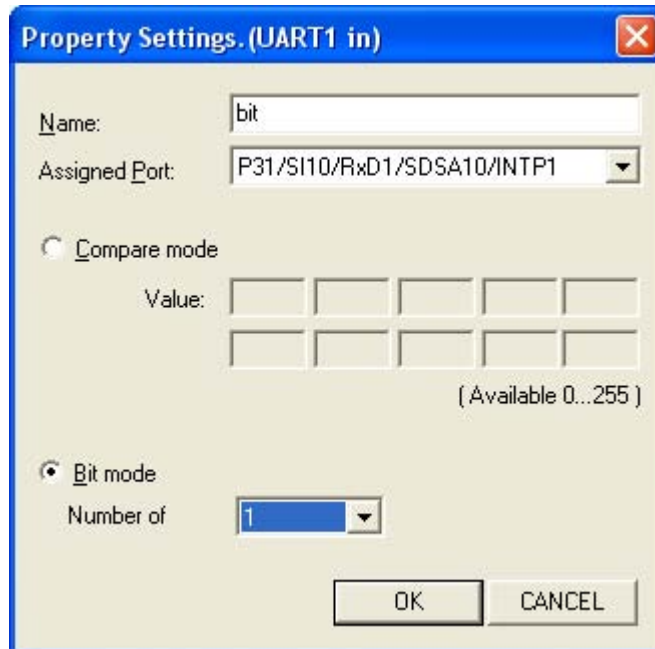

(1) **Name(N):**

Specify the name to display on the panel (second stage). (The name is not specified by default.)
This item can be omitted.

(2) **Assigned Port(P):**

The RxD1 pin is fixed as the input pin (and cannot be changed).

(3) **Selecting the type**

Select either type by using the option buttons, and then specify the required values (not specified by default).

(a) **Compare mode(C): Value:**

If the received data matches the specified values, output is enabled. If multiple values are specified, the panel is stretched vertically (up to 10 stages) according to the specified values and the output of each specified value is passed to the processing block.

Up to 10 values in the range from 0 to 255 can be specified. (Values outside the range and identical values are ignored.)

(b) **Bit mode(B): Number of:**

Each bit of received data is enabled and output if the number of output bits is 1. The panel is stretched vertically (up to 8 stages) according to the specified number of output bits and the output of each bit is passed to the processing block.

From the drop-down list, select how many of the higher bits (1 to 8) to output.

[Remark] Check the communication parameters in the [UART1 Settings dialog box](#).

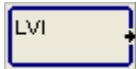

Property settings of [LVI] panel

Input panel

- 78K0S/Kx1+, 78K0/Kx2, 78K0R/KE3-L, 78K0/KC2-L, TK-78K0R/KE3L, and TK-78K0/KC2L

Figure 6-13. Property Settings Dialog Box (for the [LVI] Panel)

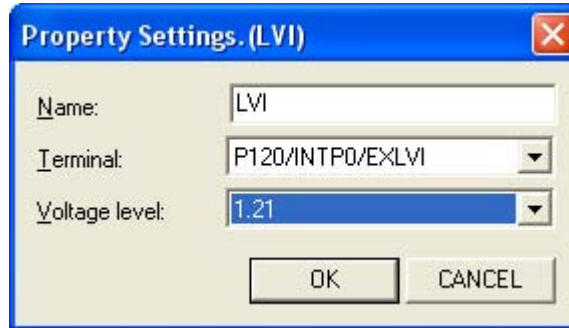
**(1) Name(N):**

Specify the name to display on the panel (second stage).
This item can be omitted.

(2) Terminal(T):

Select the pin to use from the drop-down list.
V_{DD} or EXLVI (except when using the 78K0S/Kx1+) can be selected.

(3) Voltage level(V):

This item is enabled if the voltage detection pin is specified.
Select the value of the detection level from the drop-down list.



Property settings of [Push button] panel

Input panel

- TK-78K0R/KE3L and TK-78K0/KC2L

Figure 6-14. Property Settings Dialog Box (for the [Push Button] Panel)

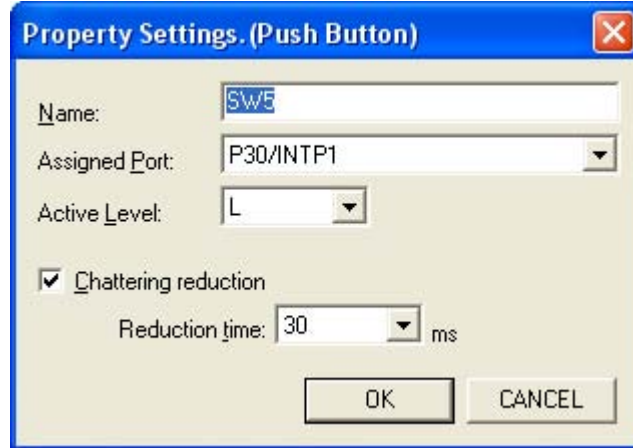
**(1) Name(N):**

Specify the name to display on the panel (second stage).

This item can be omitted.

(2) Assigned Port(P):

Fixed to the port assigned to the device (and cannot be changed).

(3) Active Level(L):

Select H (high) or L (low) as the active level from the drop-down list.

(4) Chattering reduction

Specify whether to eliminate chattering.

If the checkbox is selected, the time for eliminating chattering can be selected from 10, 20, 30, 40, 50, 60, 70, 80, 90, and 100 ms (specified as 30 ms by default).

[Remark] The default values of the items in this dialog box differ depending on the panel. (For details, see [Table 6-2 Input Panels \(\[Common\] Tab\)](#) and [Table 6-3 Input Panels \(\[TK-78K0R/KE3L I/Os\] and \[TK-78K0/KC2L I/Os\] Tabs\)](#).)

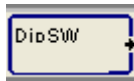

Property settings of [DIP switch] panel

Input panel

- TK-78K0R/KE3L and TK-78K0/KC2L

Figure 6-15. Property Settings Dialog Box (for the [DIP Switch] Panel)

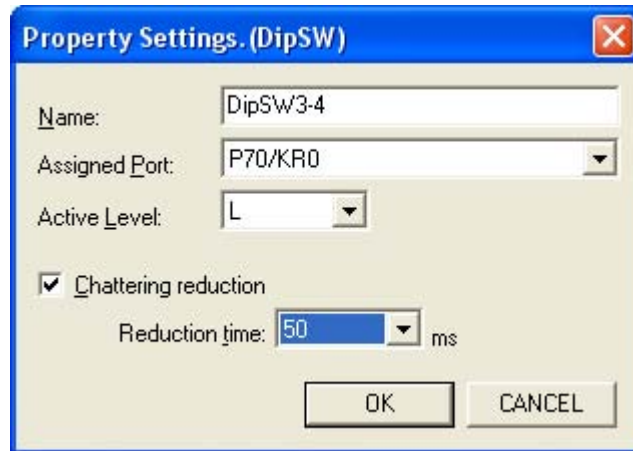
**(1) Name(N):**

Specify the name to display on the panel (second stage).
This item can be omitted.

(2) Assigned Port(P):

Fixed to the port assigned to the device (and cannot be changed).

(3) Active Level(L):

Select H (high) or L (low) as the active level from the drop-down list.

(4) Chattering reduction

Specify whether to eliminate chattering.

If the checkbox is selected, the time for eliminating chattering can be selected from 10, 20, 30, 40, 50, 60, 70, 80, 90, and 100 ms (specified as 50 ms by default).

[Remark] The default values of the items in this dialog box differ depending on the panel. (For details, see [Table 6-2 Input Panels \(\[Common\] Tab\)](#) and [Table 6-3 Input Panels \(\[TK-78K0R/KE3L I/Os\] and \[TK-78K0/KC2L I/Os\] Tabs\)](#).)

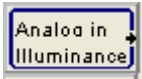

Property settings of [Analog input (illumiance)] panel

Input panel

● TK-78K0R/KE3L and TK-78K0/KC2L

Figure 6-16. Property Settings Dialog Box (for the [Analog Input (Illuminance)] Panel)

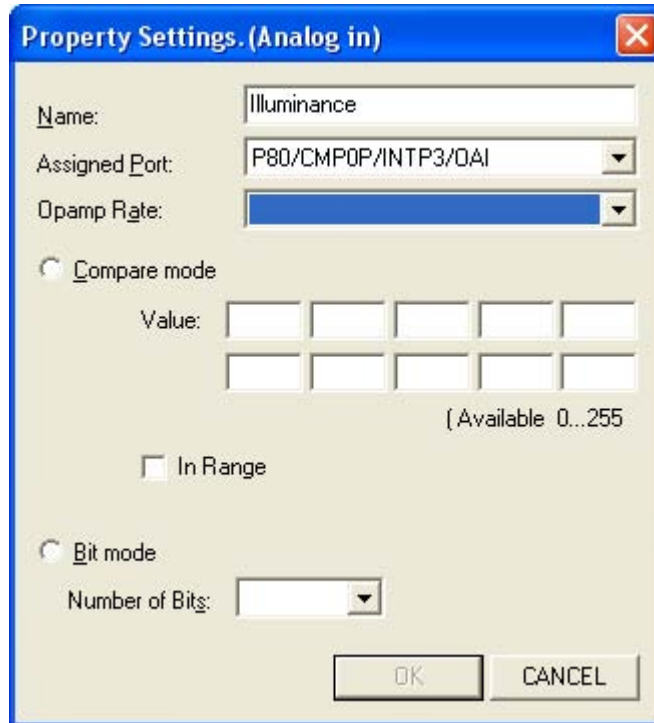
**(1) Name(N):**

Specify the name to display on the panel (second stage). (“Illuminance” is specified by default.)
This item can be omitted.

(2) Assigned Port(P):

Fixed to the port assigned to the device (and cannot be changed).

(3) Selecting the type

Select either type by using the option buttons, and then specify the required values (not specified by default).

(a) Compare mode(C): Value:

If the A/D converted values are at least these specified values, output is enabled.

However, if the “In Range” checkbox is selected, output is enabled if A/D converted values are in the range of the specified values.

If multiple values are specified, the panel is stretched vertically (up to 10 stages) according to the specified values and the output of each specified value is passed to the processing block.

Up to 10 values in the range from 0 to 255 can be specified. (Values outside the range and identical values are ignored.)

(b) Bit mode(B): Number of Bits:

Each bit of the A/D converted values is enabled and output if the number of output bits is 1. The panel is stretched vertically (up to 8 stages) according to the specified number of output bits and the output of each bit is passed to the processing block.

From the drop-down list, select how many of the higher bits (1 to 8) to output.



Property settings of [Digital output] panel



● All products

Figure 6-17. Property Settings Dialog Box (for the [Digital Output] Panel)

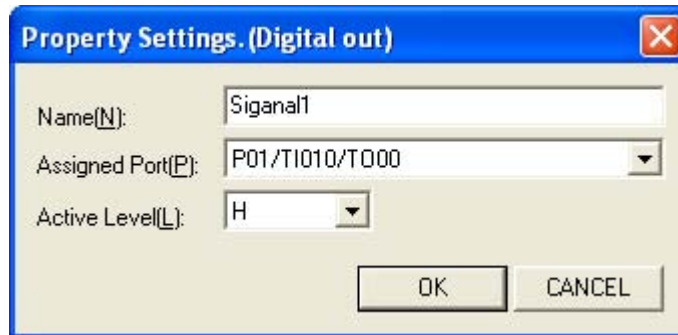
**(1) Name(N):**

Specify the name to display on the panel (second stage). (The name is not specified by default.)
This item can be omitted.

(2) Assigned Port(P):

Select the port to assign as the output pin from the drop-down list.
Make sure not to select a port that was already assigned by specifying the properties of another panel.

(3) Active Level(L):

Select H (high) or L (low) as the active level from the drop-down list. (H is selected by default.)

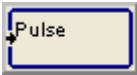

Property settings of [Simple PWM] panel

Output panel

● All products

Figure 6-18. Property Settings Dialog Box (for the [Simple PWM] Panel)

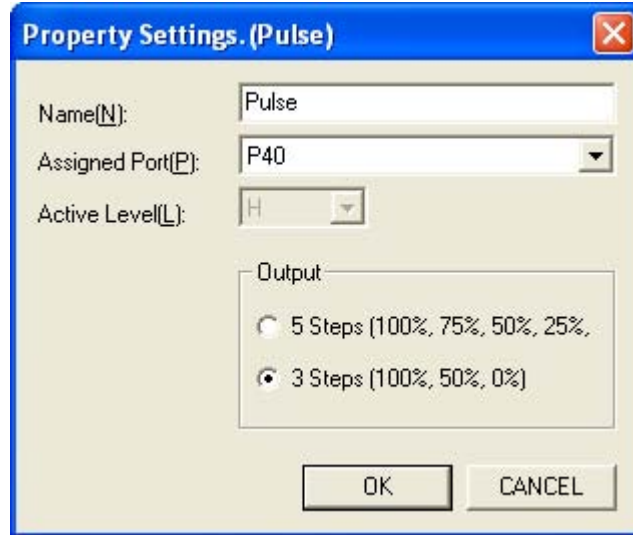

(1) **Name(N):**

Specify the name to display on the panel (second stage). (The name is not specified by default.)
This item can be omitted.

(2) **Assigned Port(P):**

Select the port to assign as the output pin from the drop-down list.
Make sure not to select a port that was already assigned by specifying the properties of another panel.

(3) **Active Level(L):**

The active level is fixed to "H".

(4) **Output**

Use the option buttons to select 3 stages or 5 stages for the duty factor. (The number of stages is not specified by default.)

By selecting either setting, the panel is stretched vertically (3 or 5 stages) and a pulse is output by enabling the input for each duty factor. The frequency is fixed and cannot be specified.

[Remark] The output signals are shown below.

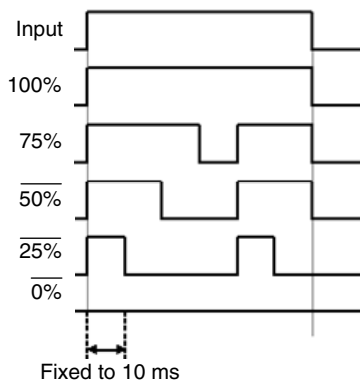

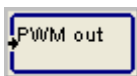

Property settings of [PWM output] panel



- μ PD78F92xx (from among the 78K0S/Kx1+ products), 78K0/Kx2, 78K0R/KE3-L, 78K0/KC2-L, TK-78K0R/KE3L, and TK-78K0/KC2L

Figure 6-19. Property Settings Dialog Box (for the [PWM Output] Panel)

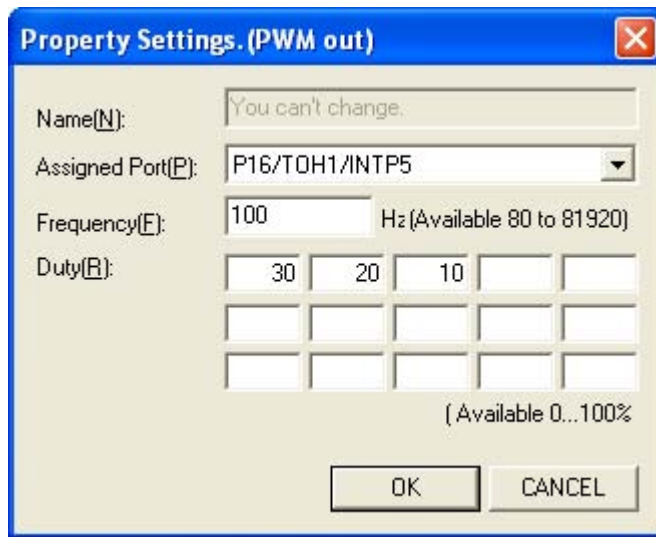

(1) Name(N):

This item cannot be specified.

(2) Assigned Port(P):

The output pin is fixed to the following pins according to the device (and cannot be changed).

Device or Board Name	Pin
78K0S/KB1+, 78K0S/KA1+	P42/TOH1
78K0S/KY1+, 78K0S/KU1+	P20/TOH1
78K0/Kx2, 78K0/KC2-L, TK-78K0/KC2L	P16/TOH1/INTP5 or P15/TOH0
78K0R/KE3-L, TK-78K0R/KE3L	P11/TI03/TO03, P13/TI05/TO05, or P52/RTC1HZ/SLTI/SLTO

(3) Frequency(F):

Specify the frequency to use in the range from 80 to 81,920 Hz. (The frequency is not specified by default.)

(4) Duty(R):

Specify the duty factor for performing PWM (pulse width modulation) using timer output. (The duty factor is not specified by default.)

Up to 15 duty factors can be specified in the range from 0 to 100%. (Values outside the range and identical values are ignored.) By specifying multiple values, the panel is stretched vertically (up to 15 stages) and a PWM signal is output at the specified duty factor by enabling the input for each duty factor.

However, output is disabled if multiple inputs are enabled at the same time.



Property settings of [UART6 output] panel

Output panel

- 78K0S/KB1+, 78K0S/KA1+, 78K0/Kx2, 78K0/KC2-L, and TK-78K0/KC2L

Figure 6-20. Property Settings Dialog Box (for the [UART6 Output] Panel)



(1) **Name(N):**

This item cannot be specified.

(2) **Assigned Port(P):**

The TxD6 pin is fixed as the output pin (and cannot be changed).

[Remark] Check the communication parameters in the [UART6 Settings dialog box](#).



Property settings of [UART0 output] panel

Output panel

- 78K0/Kx2, 78K0R/KE3-L, and TK-78K0R/KE3L

Figure 6-21. Property Settings Dialog Box (for the [UART0 Output] Panel)



(1) **Name(N):**

This item cannot be specified.

(2) **Assigned Port(P):**

The TxD0 pin is fixed as the output pin (and cannot be changed).

[Remark] Check the communication parameters in the [UART0 Settings dialog box](#).

UART1 out

Property settings of [UART1 output] panel

Output panel

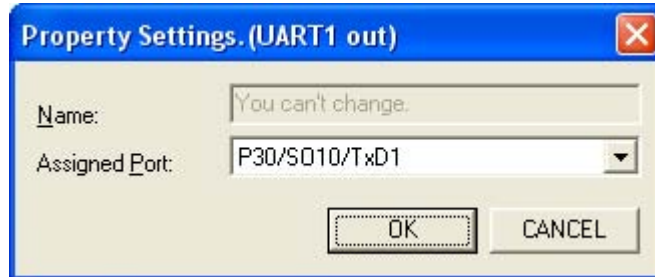
● 78K0R/KE3-L and TK-78K0R/KE3L**Figure 6-22. Property Settings Dialog Box (for the [UART1 Output] Panel)****(1) Name(N):**

This item cannot be specified.

(2) Assigned Port(P):

The TxD1 pin is fixed as the output pin (and cannot be changed).

[Remark] Check the communication parameters in the [UART1 Settings dialog box](#).

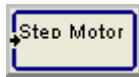

Property settings of [Step motor] panel

Output panel

- 78K0/Kx2, 78K0R/KE3-L, 78K0/KC2-L, TK-78K0R/KE3L, and TK-78K0/KC2L

Figure 6-23. Property Settings Dialog Box (for the [Step Motor] Panel)

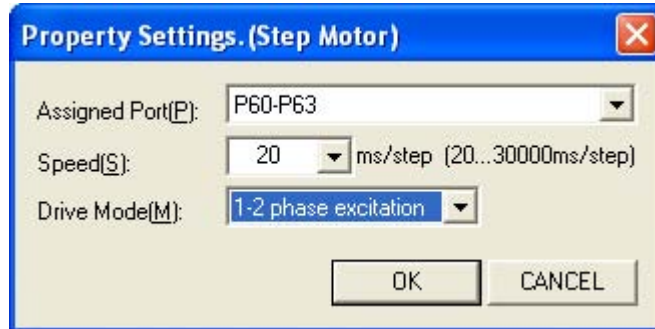
**(1) Assigned Port(P):**

Select the port to assign as the output pin from the drop-down list for the 78K0/Kx2, 78K0R/KE3-L, 78K0/KC2-L, TK-78K0R/KE3L, or TK-78K0/KC2L.

(2) Speed(S):

Select the rotation speed of the motor from the drop-down list. (The rotation speed is not specified by default.)
Select the rotation speed from 20, 50, 100, 200, 500, 1,000, 10,000, and 30,000 ms/step, or specify any value in the range from 20 to 30,000 ms/step.

(3) Drive Mode(M):

Select the motor excitation method from the drop-down list. (The method is not specified by default.)
The excitation method can be selected from three methods. The output of each method is shown below. (Motor control is fixed to four-stage output.)

- 1 phase excitation
- 1-2 phase excitation
- 2 phase excitation

[Remark] The specifiable excitation method differs for the 78K0S/Kx1+. For details, see [Property settings of \[Stepping motor\] panel](#).

(a) 1 phase excitation

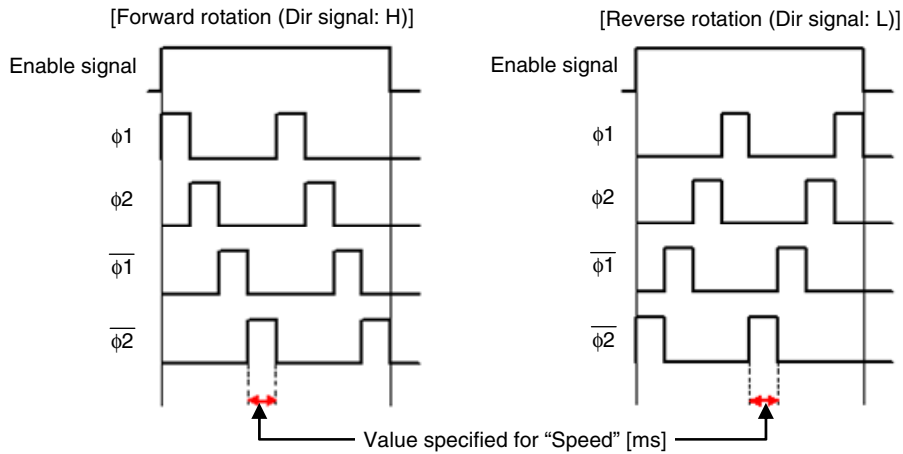

[Remark] Enable signal: Signal input to the top stage after the panel is assigned
 Dir signal: Signal input to the second highest stage after the panel is assigned

(b) 1-2 phase excitation

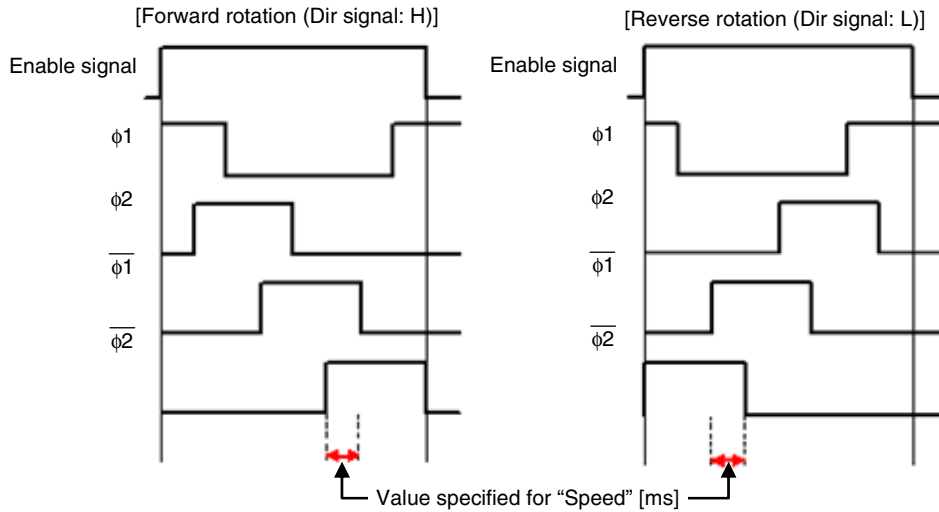

[Remark] Enable signal: Signal input to the top stage after the panel is assigned
 Dir signal: Signal input to the second highest stage after the panel is assigned

(c) 2 phase excitation

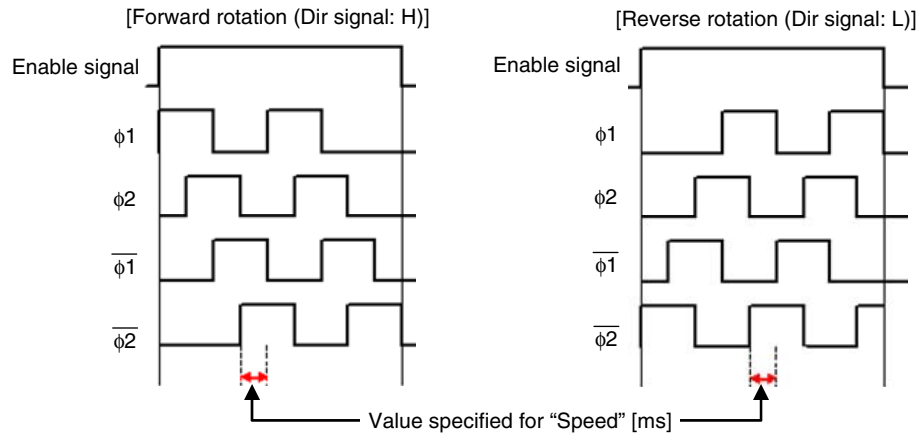

[Remark] Enable signal: Signal input to the top stage after the panel is assigned
 Dir signal: Signal input to the second highest stage after the panel is assigned

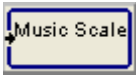

Property settings of [Musical-scale output] panel

Output panel

- μ PD78F0534 to 78F0537 (from among the 78K0/KE2 products), 78K0/KF2, 78K0R/KE3-L, and TK-78K0R/KE3L

Figure 6-24. Property Settings Dialog Box (for the [Musical-Scale Output] Panel)

**(1) Name(N):**

This item cannot be specified.

(2) Port(P):

Fixed to the P06/TI011/TO01 pin for the 78K0/KE2 and 78K0/KF2 (and cannot be changed).
Select the output pin from the drop-down list for the 78K0R/KE3-L and TK-78K0R/KE3L.

(3) Scale(C):

Specify the musical range of the output. Select the lowest and highest pitches from the drop-down list.

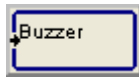

Property settings of [Buzzer] panel

Output panel

- 78K0/Kx2, 78K0/KC2-L, and TK-78K0/KC2L

Figure 6-25. Property Settings Dialog Box (for the [Buzzer] Panel)

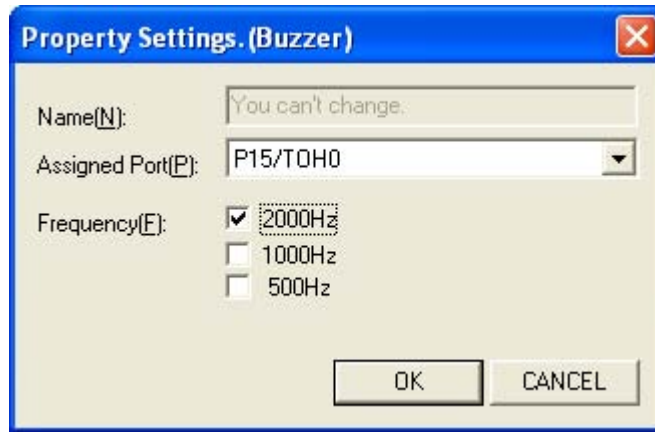
**(1) Name(N):**

This item cannot be specified.

(2) Assigned Port(P):

Fixed to the port assigned to the device (the TOH0 or TOH1 pin) (and cannot be changed).

(3) Frequency(F):

Specify the output frequency by selecting the checkboxes. (The frequency is not specified by default.)

By specifying multiple frequencies, the panel is stretched vertically (up to 3 stages), input is enabled for each output frequency, and square waves of the specified frequencies are output.

However, the output frequency is undefined if multiple inputs are enabled at the same time.

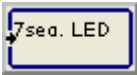

Property settings of [7-segment display] panel

Output panel

- 78K0/KE2, 78K0/KF2, TK-78K0R/KE3L, and TK-78K0/KC2L

Figure 6-26. Property Settings Dialog Box (for the [7-Segment Display] Panel)

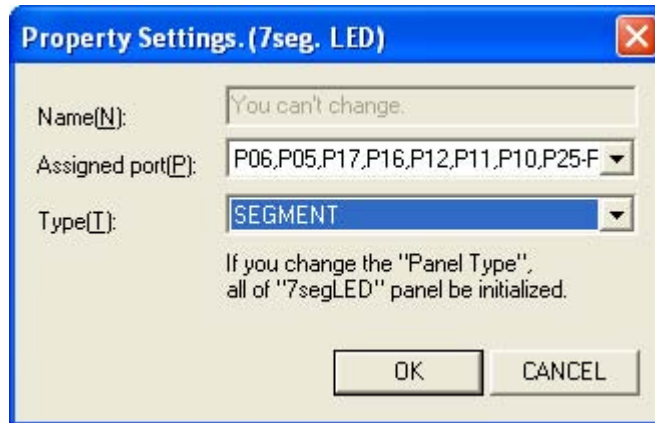
**(1) Name(N):**

This item cannot be specified.

(2) Assigned Port(P):

The output pin is fixed to the following pins according to the device (and cannot be changed).

Device or Board Name	Pin
78K0/KE2, 78K0/KF2	P06, P05, P17, P16, P12, P11, P10, P25 to P22
TK-78K0R/KE3L, TK-78K0/KC2L	P00, P01, P20 to P27

(3) Type(T):

Select the display type of the 7-segment LED from the drop-down list. (This type is not specified by default.)

(a) DIGIT

The character specified in [Property settings of \[7-segment LED jumper \(digit type\)\] panel](#) is displayed when input is enabled.

(b) SEGMENT

All segments specified in [Property settings of \[7-segment LED jumper \(segment type\)\] panel](#) are lit.

(c) BIT

Binary data is created and its numeral is displayed by assuming the bit position specified in [Property settings of \[7-segment LED jumper \(bit type\)\] panel](#) to be 1 when input is enabled.

[Caution] 7-segment LEDs of different display types cannot be used at the same time.

Therefore, if the display type is changed during editing, the [\[7-segment LED jumper\]](#) panels already assigned to the editing area () are displayed as by default and the properties must be respecified.

[Remark] When installing a 7-segment LED in the 78K0/KE2 or 78K0/KF2, connect the 7-segment LED in accordance with [APPENDIX C EXAMPLE OF THE 7-SEGMENT LED CONNECTION CIRCUIT IN THE 78K0/KE2 AND 78K0/KF2](#).



Property settings of [Jumper] panel

Processing panel

- All products

Figure 6-27. Property Settings Dialog Box (for the [Jumper] Panel)



(1) **Connection ID:**

Specify the jumper identification number in the range from 1 to 99. (This number is not specified by default.) Transmit enable or disable information from the jumper input to the jumper output that has the same identification number.

[Caution] Multiple instances of the same jumper output that have the same identification number can be specified. However, multiple instances of the same jumper input that have the same identification number cannot be specified.



Property settings of [Comparator] panel

Processing panel

- 78K0/Kx2, 78K0R/KE3-L, 78K0/KC2-L, TK-78K0R/KE3L, and TK-78K0/KC2L

Figure 6-28. Property Settings Dialog Box (for the [Comparator] Panel)

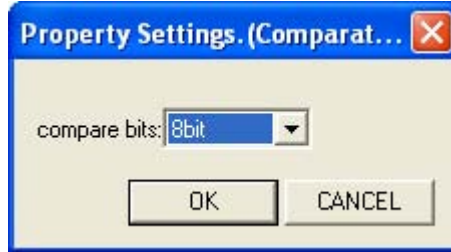

(1) **Compare bits:**

Select the number of bits to compare (4 or 8 bits) from the drop-down list. ("4bit" is selected by default.)



Property settings of [UART6 jumper output] panel

Processing panel

- 78K0S/KB1+, 78K0S/KA1+, and 78K0/Kx2

Figure 6-29. Property Settings Dialog Box (for the [UART6 Jumper Output] Panel)



[Caution] This panel is provided to secure compatibility with Appilet EZ PL V3.6 or earlier. It is used with the [\[UART6 output\]](#) output panel.

(1) Bit Number:

Specify the bit position that is the identification number of the jumper in the range from 0 to 7. (This bit position is not specified by default.)

If input is enabled, 1 is transmitted to the bit position of the [\[UART6 output\]](#) panel in the output block area, and, if input is disabled, 0 is transmitted to the bit position.



Property settings of [UART0 jumper output] panel

Processing panel

● 78K0/Kx2

Figure 6-30. Property Settings Dialog Box (for the [UART0 Jumper Output] Panel)



[Caution] This panel is provided to secure compatibility with Applilet EZ PL V3.6 or earlier. It is used with the [UART0 output] output panel.

(1) Bit Number:

Specify the bit position that is the identification number of the jumper in the range from 0 to 7. (This bit position is not specified by default.)

If input is enabled, 1 is transmitted to the bit position of the [UART0 output] panel in the output block area, and, if input is disabled, 0 is transmitted to the bit position.



Property settings of [7-segment LED jumper (digit type)] panel

Processing panel

- 78K0/KE2, 78K0/KF2, TK-78K0R/KE3L, and TK-78K0/KC2L

Figure 6-31. Property Settings Dialog Box (for the [7-Segment LED Jumper (Digit Type)] Panel)

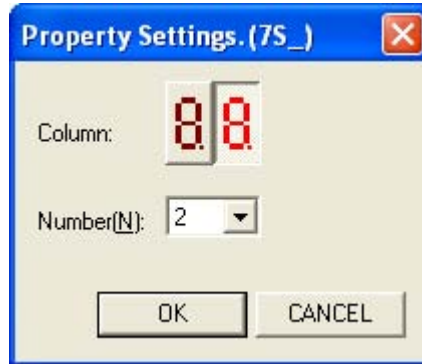

[Caution] The type of 7-segment LED to use must be prespecified in [Property settings of \[7-segment display\] panel](#).

(1) Column:

Specify the digits to display for the 7-segment LED when the input to this jumper is enabled. (These digits are not specified by default.)

If multiple panels that have the same number specified for a digit, make sure that the panels are not enabled at the same time.

(2) Number(N):

Select the character to display for the 7-segment LED (0 to 9 or A to F) from the drop-down list when the input is enabled. (This character is not specified by default.)

[Remark] When installing a 7-segment LED in the 78K0/KE2 or 78K0/KF2, connect the 7-segment LED in accordance with [APPENDIX C EXAMPLE OF THE 7-SEGMENT LED CONNECTION CIRCUIT IN THE 78K0/KE2 AND 78K0/KF2](#).



- 78K0/KE2, 78K0/KF2, TK-78K0R/KE3L, and TK-78K0/KC2L

Figure 6-32. Property Settings Dialog Box (for the [7-Segment LED Jumper (Segment Type)] Panel)

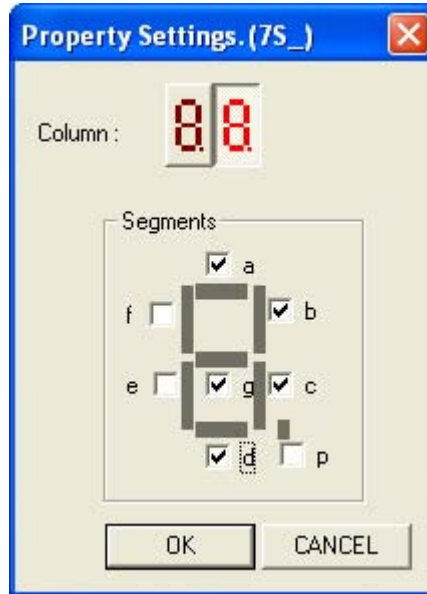

[Caution] The type of 7-segment LED to use must be prespecified in [Property settings of \[7-segment display\] panel](#).

(1) Column:

Specify the digits to display for the 7-segment LED when the input to this jumper is enabled. (These digits are not specified by default.)

(2) Segments:

Specify the segments (a to g or p) of the 7-segment LED to light when input is enabled. (These segments are not specified by default.)

Multiple checkboxes can be selected.

[Remark] When installing a 7-segment LED in the 78K0/KE2 or 78K0/KF2, connect the 7-segment LED in accordance with [APPENDIX C EXAMPLE OF THE 7-SEGMENT LED CONNECTION CIRCUIT IN THE 78K0/KE2 AND 78K0/KF2](#).



Property settings of [7-segment LED jumper (bit type)] panel

Processing panel

- 78K0/KE2, 78K0/KF2, TK-78K0R/KE3L, and TK-78K0/KC2L

Figure 6-33. Property Settings Dialog Box (for the [7-Segment LED Jumper (Bit Type)] Panel)



[Caution] The type of 7-segment LED to use must be prespecified in [Property settings of \[7-segment display\] panel](#).

(1) **Bit Number:**

Specify the bit position of the binary data of the numerical value to display for the 7-segment LED in the range from 0 to 7 when input to this jumper is enabled. (This bit position is not specified by default.)

[Remark] When installing a 7-segment LED in the 78K0/KE2 or 78K0/KF2, connect the 7-segment LED in accordance with [APPENDIX C EXAMPLE OF THE 7-SEGMENT LED CONNECTION CIRCUIT IN THE 78K0/KE2 AND 78K0/KF2](#).



Property settings of [Flip-flop] panel

Processing panel

● All products

Figure 6-34. Property Settings Dialog Box (for the [Flip-Flop] Panel)



(1) Type(T):

Select the operation type of the flip-flop (RS-FF, D-FF, T-FF, or JK-FF) from the drop-down list. (This type is not specified by default.)

The truth table for each operation type is shown below.

Table 6-10. Truth Values for Each Flip-Flop Operation

RS-FF				D-FF			
S	R	Q	\bar{Q}	D	C	Q	\bar{Q}
0	0	Retain	$\bar{\text{Retain}}$	0	↑	0	1
0	1	0	1	1	↑	1	0
1	0	1	0	X	0	Retain	$\bar{\text{Retain}}$
1	1	0 ^[Note]	0 ^[Note]	X	1	Retain	$\bar{\text{Retain}}$
				X	↓	Retain	$\bar{\text{Retain}}$

T-FF				JK-FF				
T	R	Q	\bar{Q}	J	K	CK	Q	\bar{Q}
0	1	Retain	$\bar{\text{Retain}}$	0	0	X	Retain	$\bar{\text{Retain}}$
↑	1	Invert	$\bar{\text{Invert}}$	0	1	X	Retain	$\bar{\text{Retain}}$
1	1	Retain	$\bar{\text{Retain}}$	1	0	X	Retain	$\bar{\text{Retain}}$
↓	1	Retain	$\bar{\text{Retain}}$	1	1	X	Retain	$\bar{\text{Retain}}$
x	0	0	1	0	0	↑	Retain	$\bar{\text{Retain}}$
				0	1	↑	0	1
				1	0	↑	1	0
				1	1	↑	Invert	$\bar{\text{Invert}}$

0 = Off, 1 = On, ↑: Change from off to on, ↓: Change from on to off, X = Not specified

[Note] Generally, input is disabled (and output is undefined), but output is disabled with a reset prioritized in Applilet EZ PL.

(2) Initial value(I):

Specify 0 or 1 as the initial value during operation.

If the operation type is not specified, the initial value is not specified. 0 is specified every time the operation type is specified.



Property settings of [Counter] panel

Processing panel

● All products

Figure 6-35. Property Settings Dialog Box (for the [Counter] Panel)

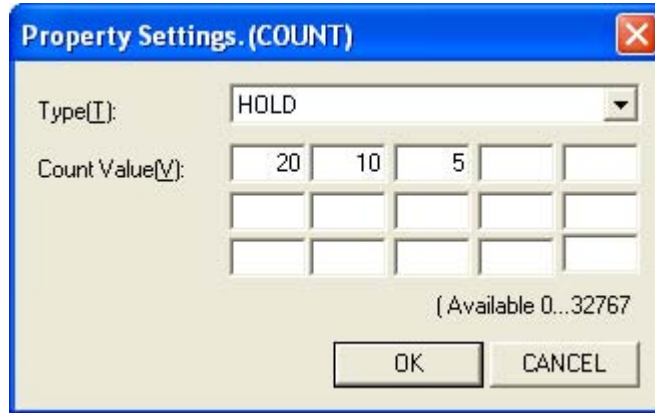
(1) **Type(T):**

Select the operation type of the counter from the drop-down list. (This type is not specified by default.)

(a) **HOLD**

The counter is incremented every time the clock input is disabled. If the count value matches the value specified in the properties, the output is enabled. The counter stops at the maximum count value.

(b) **CYCLIC**

The counter is incremented every time the clock input is disabled. If the count value matches the value specified in the properties, the output is enabled. The counter is reset (0) at the maximum count value when a signal is input.

(2) **Count Value(V):**

Specify the value by which output is enabled. (This value is not specified by default.)

Up to 15 values in the range from 0 to 32,767 can be specified. (Values outside the range and identical values are ignored.) By specifying multiple values, the panel is stretched vertically (up to 15 stages) and multiple outputs can be processed.

The initial value of the counter is 0. Input from a higher block is assumed to be a reset signal and that resets the counter to the initial value.



Property settings of [Binary counter] panel

Processing panel

● All products

Figure 6-36. Property Settings Dialog Box (for the [Binary Counter] Panel)

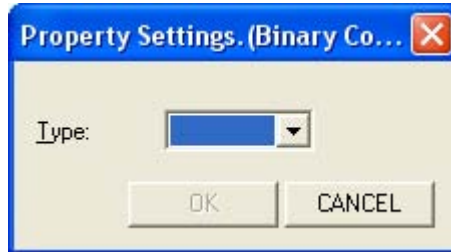
(1) **Type(T):**

Select the operation type of the binary counter from the drop-down list. (This type is not specified by default.)

(a) **BCD mode**

The counter is incremented from 0 to 9 and the counter returns to 0 after being incremented to 9.

(b) **HEX mode**

The counter is incremented from 0 to 15 (F in hexadecimal) and the counter returns to 0 after being incremented to F.

The truth table for the binary counter is shown below.

Table 6-11. Truth Values for Binary Counter Operations

Binary Counter			
CP0	CP1	MR	Output
↑	1	0	Increment
0	↓	0	Increment
↓	X	0	Retain
X	↑	0	Retain
↑	0	0	Retain
1	↓	0	Retain
X	X	1	O0 = O1 = O2 = O3 = 0

0 = Off, 1 = On, ↑: Change from off to on, ↓: Change from on to off, X = Not specified



Property settings of [Timer] panel

Processing panel

● All products

Figure 6-37. Property Settings Dialog Box (for the [Timer] Panel)



(1) Type(T):

Select the operation type of the timer from the drop-down list. (This type is not specified by default.)

(a) HOLD

The output is enabled when the specified time elapses after the input is enabled.
The input remains enabled after the output is enabled.

(b) TOGGLE

The output is enabled when the specified time elapses after the input is enabled.
The input is alternately enabled and disabled in the specified time cycle after the output is enabled.

(c) ONE-SHOT

The output is enabled when the input is enabled and disabled when the specified time elapses.
A change in the input information does not affect the period during which the output is enabled.

(d) ONE-SHOT (RETRIGGERABLE)

The output is enabled when the input is enabled and disabled when the specified time elapses.
The timer restarts if the input is enabled again while the output is enabled.

(2) Time Setting(S):

Specify the time of timer operations in the following dialog box, which is opened by clicking [Set...].

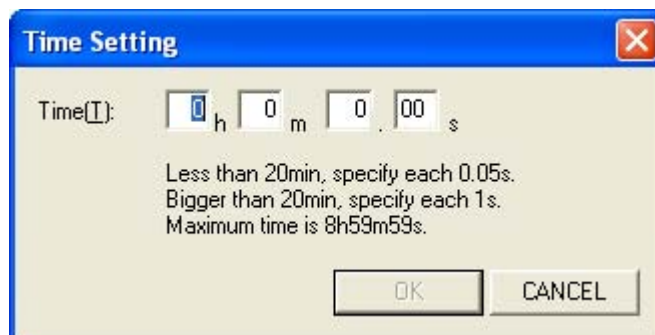

(a) Time(T):

Up to 8 hours 59 minutes and 59 seconds can be specified in 0.05 second units if the specified time is less than 20 minutes or in 1 second units if the specified time is at least 20 minutes. (This time is not specified by default.)

For input in 0.01 second units, the time is rounded to the nearest value in 0.05 second units after input.



Property settings of [Delay] panel

Processing panel

- All products

Figure 6-38. Property Settings Dialog Box (for the [Delay] Panel)

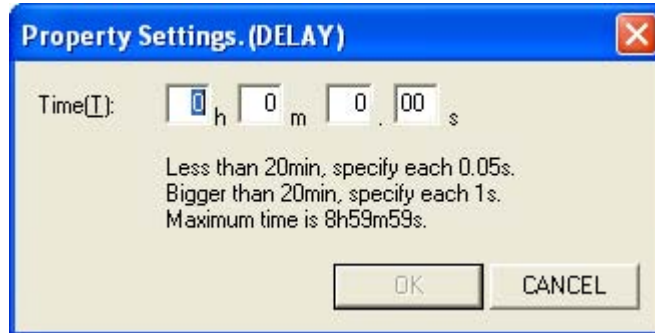

(1) Time(T):

When the time specified in the properties elapses after the input signal changes, the same signal as that previously input is output.

Up to 8 hours 59 minutes and 59 seconds can be specified in 0.05 second units if the specified time is less than 20 minutes or in 1 second units if the specified time is at least 20 minutes. (This time is not specified by default.)

For input in 0.01 second units, the time is rounded to the nearest value in 0.05 second units after input.

If the input signal changes before a signal is output, the time is measured again from that point. Therefore, if the input signal is inverted within the specified time, the output signal does not change.



Property settings of [Clock] panel

Processing panel

● All products

Figure 6-39. Property Settings Dialog Box (for the [Clock] Panel)

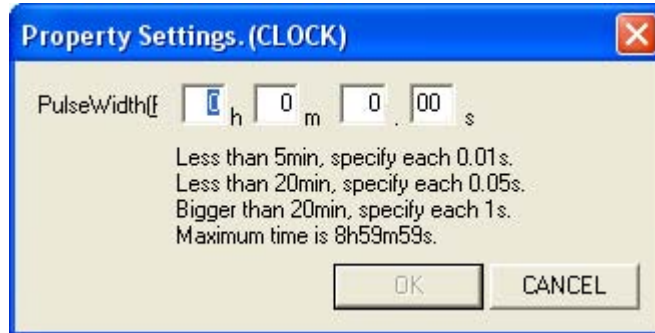
**(1) Pulse Width(P):**

A width from 0.01 seconds to 8 hours 59 minutes and 59 seconds can be specified in 0.01 second units if the specified time is less than 5 minutes, in 0.05 second units if the specified time is less than 20 minutes, or in 1 second units if the specified time is at least 20 minutes. (This width is not specified by default.)



Property settings of [Stepping motor] panel

Processing panel

● 78K0S/Kx1+

Figure 6-40. Property Settings Dialog Box (for the [Stepping Motor] Panel)

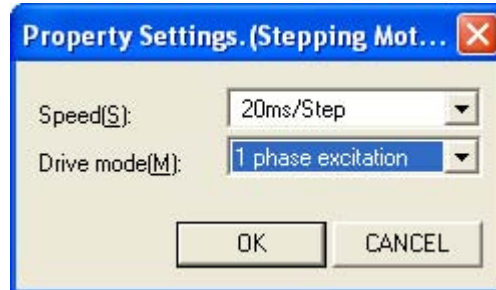
**(1) Speed(S):**

Select the rotation speed of the motor from the drop-down list. (The rotation speed is not specified by default.)
Select the rotation speed from 10, 20, 30, 40, 50, and 100 ms/step.

(2) Drive mode(M):

Select the motor excitation method from the drop-down list. (The method is not specified by default.)
The excitation method can be selected from two methods. The output of each method is shown below. (Motor control is fixed to four-stage output.)

- 1 phase excitation
- 2 phase excitation

[Remark] The specifiable excitation method differs for the 78K0/Kx2, 78K0R/KE3-L, 78K0/KC2-L, TK-78K0R/KE3L, and TK-78K0/KC2L. For details, see [Property settings of \[Step motor\] panel](#).

(a) 1 phase excitation

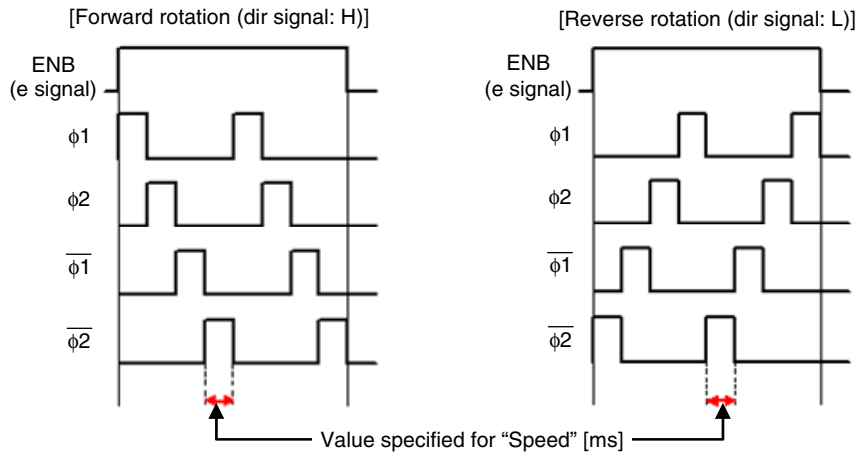

[Remark] e signal: Signal input from above after the panel is assigned
 dir signal: Signal input from the left after the panel is assigned

(b) 2 phase excitation

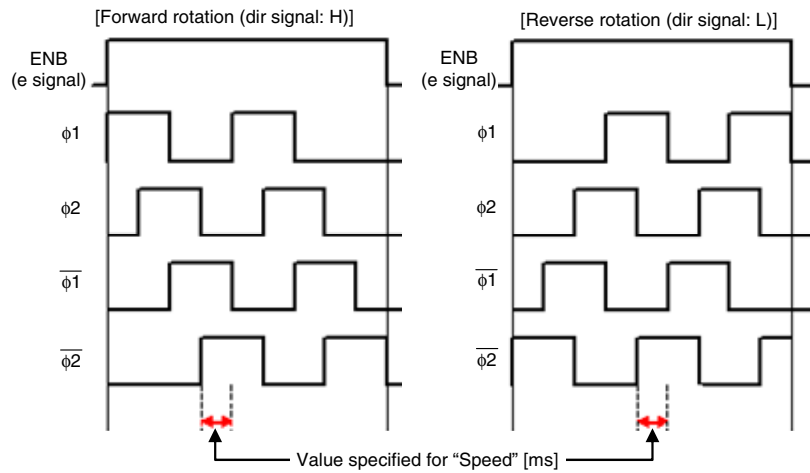

[Remark] e signal: Signal input from above after the panel is assigned
 dir signal: Signal input from the left after the panel is assigned



Property settings of [Reset] panel

Processing panel

● All products

Figure 6-41. Property Settings Dialog Box (for the [Reset] Panel)



(1) Input(I):

Select 0 or 1. (This value is not specified by default.)

Port Setting dialog box

This dialog box displays the I/O ports that are currently specified in the properties.
This dialog box is opened by selecting the [View] menu and then [Assigned ports].

Figure 6-42. Port Setting Dialog Box

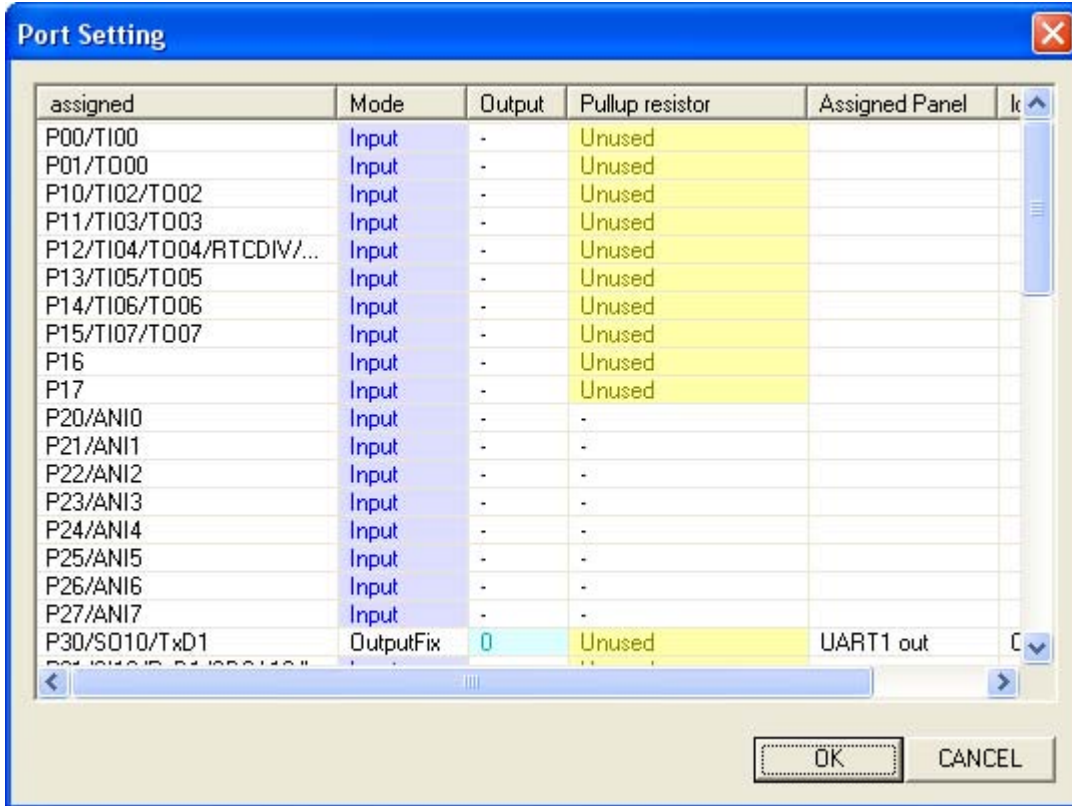

The following items are described below:



- Columns in the Port Setting dialog box
- Function buttons

Columns in the Port Setting dialog box

The meanings of the columns are as follows.

Item	Meaning
assigned	The ports of the selected device or board are listed in this column.
Mode	The I/O modes of the ports are displayed in this column. (The default is "Input".) The mode can be switched between "Input" and "Output" by double-clicking it. The mode cannot be changed if "InputFix" or "OutputFix" is displayed.
Output	If the mode is "Output" or "OutputFix", the output value is displayed. (This value is "0" by default.) The value can be switched between "0" and "1" by double-clicking it.
Pullup resistor	Whether an on-chip pull-up resistor is used is displayed in this column. (The default is "Unused".) The status can be switched between "Used" and "Unused" by double-clicking it.
Assigned Panel	The name of a panel is indicated in this column.
location	IN or OUT: Indicates an input or output panel. 01, 02, 03, ...: Separately indicates the position of the panel for the input block and output block areas by using a block number, assuming the upper block to be 1.

Function buttons

Button	Function
	Applies the settings and closes the Port Setting dialog box.
	Does not apply the settings and closes the Port Setting dialog box.

Target CPU Settings dialog box

Specify the device or board to use in this dialog box.

This dialog box is opened by selecting the [Settings] menu and then [Target CPU].

Figure 6-43. Target CPU Settings Dialog Box

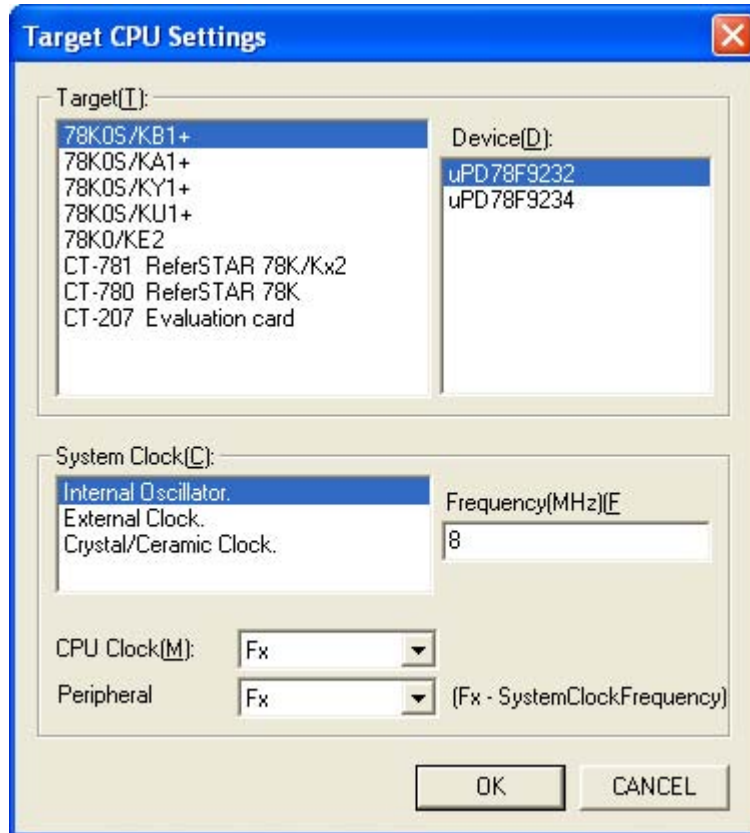

The following items are described below:

- [Items in the Target CPU Settings dialog box](#)
- [Function buttons](#)

Items in the Target CPU Settings dialog box

(1) Target(T):

Specify the device or board to use.

(2) Device(D):

Specify the device to use after specifying the target.

(3) System Clock(C):

Specify the source of the clock to supply to the 78K0/Kx2, 78K0S/Kx1+, 78K0R/KE3-L, or 78K0/KC2-L.

- Internal Oscillator

Specify this if using the internal high-speed oscillator in the 78K0/Kx2, 78K0S/Kx1+, 78K0R/KE3-L, or 78K0/KC2-L.

- External Clock
Specify this if using an external clock.
- Crystal/Ceramic Clock
Specify this if using a clock source other than the previous two sources.

(4) Frequency (MHz)(F):

Oscillation frequency of the target to use

(5) CPU Clock(M), Peripheral:

Specify the CPU clock and peripheral clock to use.

[Caution] The items that can be specified for the system clock source and the values that can be entered for the frequency differ depending on the device or board. For details, see the user's manual for each device or board.

Function buttons

Button	Function
OK	Applies the settings and closes the Target CPU Settings dialog box.
CANCEL	Does not apply the settings and closes the Target CPU Settings dialog box.

Watchdog Timer Setting dialog box

Specify the use of the watchdog timer and its settings in this dialog box.

This dialog box is opened by selecting the [Settings] menu, [CPU Function], and then [Watchdog timer].

Figure 6-44. Watchdog Timer Setting Dialog Box

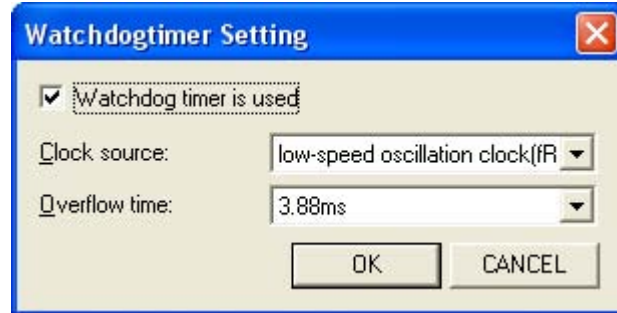

The following items are described below:

- [Items in the Watchdog Timer Setting dialog box](#)
- [Function buttons](#)

Items in the Watchdog Timer Setting dialog box

(1) Watchdog timer is used

Select this checkbox if using the watchdog timer.

(2) Clock source(C):

This item can be selected if the checkbox in (1) is selected.

Select the internal low-speed oscillation clock (fRL) or main system clock (Fx) for the 78K0S/Kx1+.

This item is fixed to the internal low-speed oscillation clock (fRL) for other devices (and cannot be changed).

(3) Overflow time(T):

This item can be selected if the checkbox in (1) and the clock in (2) are selected.

Select the overflow time from the drop-down list.

Function buttons

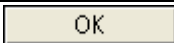
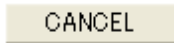
Button	Function
	Applies the settings and closes the Watchdog Timer Setting dialog box.
	Does not apply the settings and closes the Watchdog Timer Setting dialog box.

UART0 Settings dialog box

Specify the UART0 I/O properties in this dialog box.

This dialog box is opened by selecting the [Settings] menu, [CPU Function], and then [UART0].

Figure 6-45. UART0 Settings Dialog Box

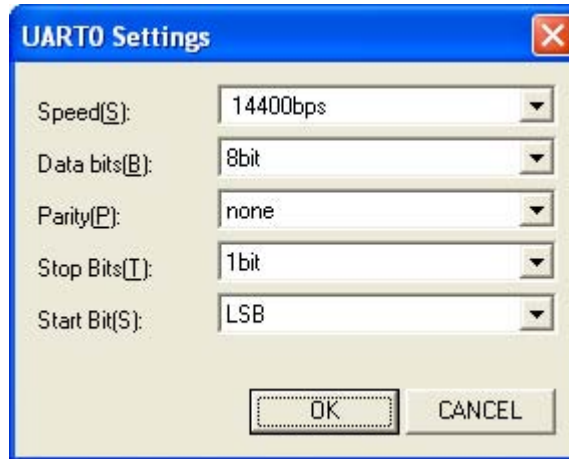

The following items are described below:

- [Items in the UART0 Settings dialog box](#)
- [Function buttons](#)

Items in the UART0 Settings dialog box

(1) Speed(S):

Select the UART0 communication speed from the drop-down list.

The values that can be selected depend on the target CPU and specified peripheral clock.

(2) Data bits(B):

Select the number of UART0 data bits from the drop-down list.

5 bits (only for 78K0R/KE3-L and TK-78K0R/KE3L), 7 bits, or 8 bits can be selected.

The selected number of bits is reflected in the number of stages of UART0 output panels assigned to the output block area.

(3) Parity(P):

Select the UART0 parity setting from the drop-down list.

No parity, 0 parity output, odd parity output, or even parity output can be selected.

(4) Stop Bits(T):

Select the number of UART0 stop bits from the drop-down list.

1 bit or 2 bits can be selected.

(5) Start Bit(S):

Select the UART0 start bit from the drop-down list.

The start bit is fixed to LSB for the 78K0/Kx2.

MSB or LSB can be selected for other devices.

Function buttons

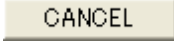
Button	Function
	Applies the settings and closes the UART0 Settings dialog box.
	Does not apply the settings and closes the UART0 Settings dialog box.

UART1 Settings dialog box

Specify the UART1 I/O properties in this dialog box.

This dialog box is opened by selecting the [Settings] menu, [CPU Function], and then [UART1].

Figure 6-46. UART1 Settings Dialog Box

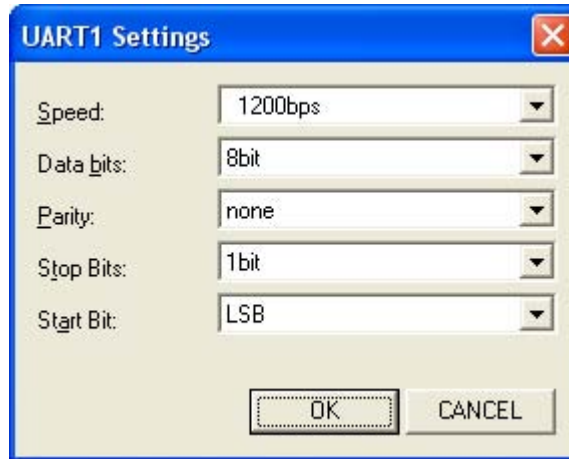

The following items are described below:

- [Items in the UART1 Settings dialog box](#)
- [Function buttons](#)

Items in the UART1 Settings dialog box

(1) Speed(S):

Select the UART1 communication speed from the drop-down list.
The values that can be selected depend on the specified peripheral clock.

(2) Data bits(B):

Select the number of UART1 data bits from the drop-down list.
5 bits, 7 bits, or 8 bits can be selected.
The selected number of bits is reflected in the number of stages of UART1 output panels assigned to the output block area.

(3) Parity(P):

Select the UART1 parity setting from the drop-down list.
No parity, 0 parity output, odd parity output, or even parity output can be selected.



(4) Stop Bits(T):

Select the number of UART1 stop bits from the drop-down list.
1 bit or 2 bits can be selected.

(5) Start Bit(S):

Select the UART1 start bit from the drop-down list.
MSB or LSB can be selected.

Function buttons

Button	Function
	Applies the settings and closes the UART1 Settings dialog box.
	Does not apply the settings and closes the UART1 Settings dialog box.

UART6 Settings dialog box

Specify the UART6 I/O properties in this dialog box.

This dialog box is opened by selecting the [Settings] menu, [CPU Function], and then [UART6].

Figure 6-47. UART6 Settings Dialog Box

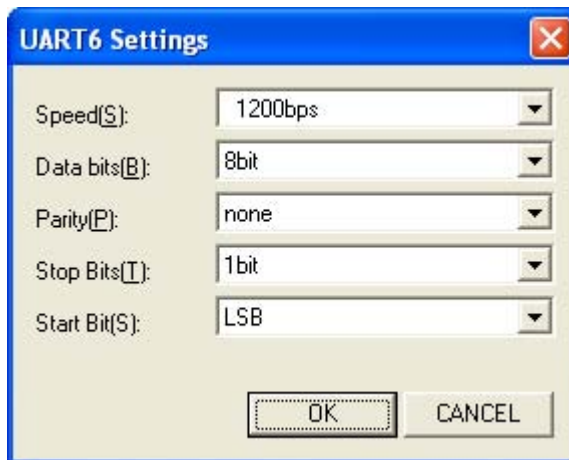

The following items are described below:

- [Items in the UART6 Settings dialog box](#)
- [Function buttons](#)

Items in the UART6 Settings dialog box

(1) Speed(S):

Select the UART6 communication speed from the drop-down list.

The values that can be selected depend on the target CPU and specified peripheral clock.

(2) Data bits(B):

Select the number of UART6 data bits from the drop-down list.

7 bits or 8 bits can be selected.

The selected number of bits is reflected in the number of stages of UART6 output panels assigned to the output block area.

(3) Parity(P):

Select the UART6 parity setting from the drop-down list.

No parity, 0 parity output, odd parity output, or even parity output can be selected.

(4) Stop Bits(T):

Select the number of UART6 stop bits from the drop-down list.



1 bit or 2 bits can be selected.

(5) Start Bit(S):

Select the UART6 start bit from the drop-down list.

MSB or LSB can be selected.

Function buttons

Button	Function
	Applies the settings and closes the UART6 Settings dialog box.
	Does not apply the settings and closes the UART6 Settings dialog box.

Flash Memory Programmer Settings dialog box

In this dialog box, specify the settings when writing to the flash memory provided on the device or board by using Applilet EZ PL. The items displayed in this dialog box differ depending on the device or board selected in the Target CPU Settings dialog box. Specify the settings according to the description below.

This dialog box is opened by selecting the [Settings] menu and then [FLASH memory programmer].

- If a device is selected in the Target CPU Settings dialog box

Figure 6-48. Flash Memory Programmer Settings Dialog Box (for a Device)

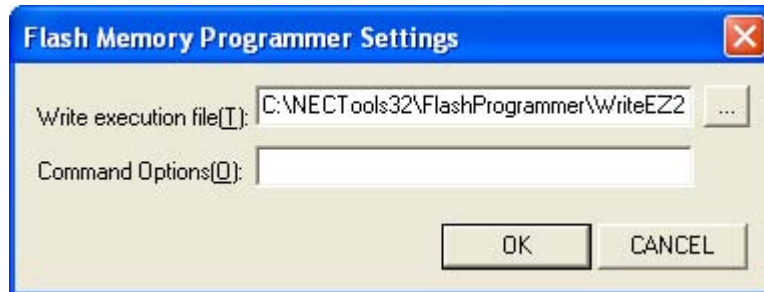

The following items are described below:

- [Items in the Flash Memory Programmer Settings dialog box \(for a device\)](#)
- [Function buttons \(common\)](#) (see next page)

Items in the Flash Memory Programmer Settings dialog box (for a device)

(1) Write execution file(T):

Specify the file name of the flash memory programmer to add, including the full file path.

(2) Command Options(O):

Specify startup parameters as required.

- If an evaluation board [Note] is selected in the Target CPU Settings dialog box

Figure 6-49. Flash Memory Programmer Settings Dialog Box (for an Evaluation Board [Note])

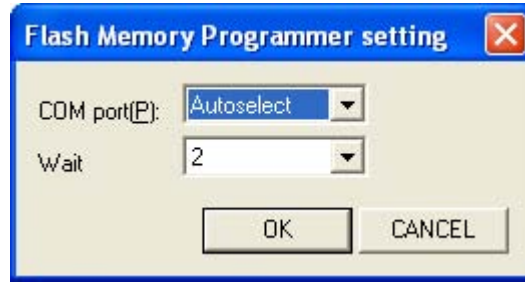

The following items are described below:

- [Items in the Flash Memory Programmer Settings dialog box \(for an evaluation board \[Note\]\)](#)
- [Function buttons \(common\)](#)

Items in the Flash Memory Programmer Settings dialog box (for an evaluation board [Note])

(1) COM port(P):

Select the COM port to use for writing to the flash memory from the drop-down list. (“Autoselect” is specified by default [Note].)

(2) Wait

If there is no problem in writing to the flash memory, use the default value “2”. If data cannot be written to the flash memory, or if a communication error has occurred, select a greater value from the drop-down list.

Function buttons (common)

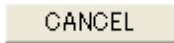
Button	Function
	Applies the settings and closes the Flash Memory Programmer Settings dialog box.
	Does not apply the settings and closes the Flash Memory Programmer Settings dialog box.

[Note] Automatic detection cannot be used for some evaluation boards. See [3.2.2 Setting up Applilet EZ PL](#) for details.

Saved Data Folder dialog box

Specify where to save data in this dialog box.

This dialog box is opened by selecting the [Settings] menu and then [Folders].

Figure 6-50. Saved Data Folder Dialog Box



The following items are described below:

- [Items in the Saved Data Folder dialog box](#)
- [Function buttons](#)

Items in the Saved Data Folder dialog box

(1) Project Folder(P)

“C:...\My Documents\Applilet EZ PL\Project” is specified by default. (The location of the My Documents folder differs depending on the PC environment and settings.)

A desired location can also be specified.

(2) Location

“C:...\My Documents\Applilet EZ PL\Save” is specified by default. (The location of the My Documents folder differs depending on the PC environment and settings.)

A desired location can also be specified.



[Caution] If a version of Applilet EZ PL earlier than Ver.2.x is installed, project and location files are saved to the following folders by default.

Project files: C:\Program Files\Applilet EZ PL\Project

Location files: C:\Program Files\Applilet EZ PL\Save

If a version of Applilet EZ PL earlier than Ver.2.x is installed to a folder other than the default, project and location files are saved in the My Documents folder. In this case, manually change the folder.

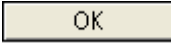
Function buttons

Button	Function
	Applies the settings and closes the Saved Data Folder dialog box.
	Does not apply the settings and closes the Saved Data Folder dialog box.

7.1 When Editing a Panel

The meanings of the error messages displayed when editing a panel are described below.

Figure 7-1. Example of an Error Message Displayed When Editing a Panel



“Unable to change size.”

This message is displayed if a panel cannot be vertically stretched by specifying or changing the properties due to the presence of other panels.

Make sure to secure the required number of vacant blocks before specifying or changing the properties.

“The range for generating an object has been exceeded. Reduce the number of panels.”

This message is displayed if the number of assigned processing panels exceeds the maximum value for generating object code.

Assign panels so that the ROM size does not exceed the size of the flash ROM provided in the product. (Watch the [Status bar](#) when assigning panels **[Note]**.)

[Note] The estimated ROM size differs from the result of actual compilation.

7.2 When Compiling or Writing to Flash Memory

The meanings of and countermeasures for the error messages displayed when object code (*.hex) is automatically generated or data is written to the flash memory by selecting the [Run] menu and then [Build & Write] are described below.

Figure 7-2. Example of an Error Message Displayed When Compiling or Writing to Flash Memory

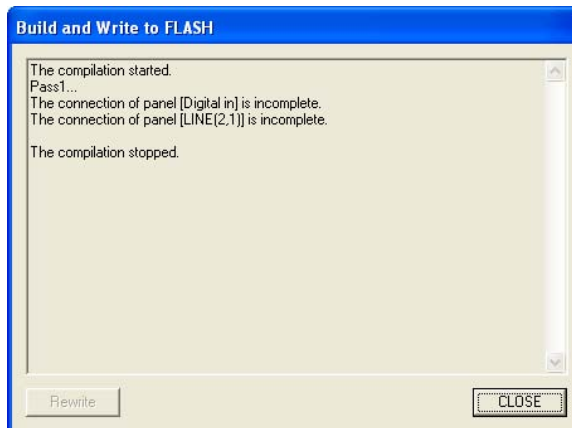

“The compilation stopped.”

This message is displayed if compilation stops due to the detection of an error during compilation.

“The same port is assigned to multiple I/O panels. port=xxxxx”

This message is displayed if the same port is specified in the property settings of multiple I/O panels.

Check for ports that have been specified more than once in the [Port Setting dialog box](#).



(xxxxx: Name of a port that has been specified more than once)

“The properties of nnnnn (zzzz) are not specified.”

This message is displayed if the properties of an I/O panel for which the properties must be specified are not specified.

(nnnnn: Panel name, zzzz: Name specified in the properties)

[Countermeasure]



Check for panels marked by a  mark in the editing area. (The  mark indicates that the properties are not specified.)

Make sure that there are no panels whose properties are not specified.

“The properties of nnnnn (x, y) are not specified.”

This message is displayed if the properties of an I/O panel for which the properties must be specified are not specified.

(nnnnn: Panel name, x, y: Block coordinates, taking the upper left corner of the processing block area as (1, 1))

Check for panels marked by a  mark in the editing area. (The  mark indicates that the properties are not specified.)

Make sure that there are no panels whose properties are not specified.

“There is no connection adjacent to nnnnn (zzzz).”

This message is displayed if a panel is disconnected.

(nnnnn: Panel name, zzzz: Name specified in the properties)

[Countermeasure]

Assigned panels must be wired. Check for panels not connected to other panels, and then execute compilation.

(Delete panels that will not be used.)

“There is no connection adjacent to nnnnn (x, y).”

This message is displayed if a panel is disconnected.

(nnnnn: Panel name, x, y: Block coordinates, taking the upper left corner of the processing block area as (1, 1))

[Countermeasure]

Assigned panels must be wired. Check for panels not connected to other panels, and then execute compilation.

(Delete panels that will not be used.)

“The jumper that has the identification number %d is not connected.”

This message is displayed if jumper connections are insufficient.

[Countermeasure]

Assigned panels must be wired. Check for panels not connected to other panels, and then execute compilation.
(Delete panels that will not be used.)

“Running the command failed. (Command name, error code)”

This message is displayed if running the assembler, linker, or object converter failed during compilation.

The ApEZPL.ini file might have been changed after installing Applilet EZ PL.

“Assembling failed.”

This message is displayed if an error is detected during assembling.

“An error was detected.”

This message is displayed if an error other than the above is detected during compilation.

Make sure that no more than 10 counter, timer, and delay panels have been assigned in total (only for the 78K0S/Kx1+).

“The writer command is not specified.”

This message is displayed if the command for writing to flash memory is not specified in the ApEZPL.ini file.

The ApEZPL.ini file might have been changed after installing Applilet EZ PL.

[Countermeasure]

Uninstall and then reinstall Applilet EZ PL.

“Execution failed.”

This message is displayed if the flash writer was not terminated. (Termination of flash writing could not be recognized.)

Check the settings in the [Flash Memory Programmer Settings dialog box](#) and those for the evaluation board.

“The flash memory will not be written.”

This message is displayed if [Cancel] is clicked in the dialog box for confirming the execution of writing to flash memory.

“Writing failed. code=xx”

This message is displayed if writing to flash memory failed.

Check the connections on the evaluation board and the switch settings.

Perform the following countermeasures according to the displayed code number (xx).

“code=0” means that the flash memory was successfully written.

Code Number	Countermeasure
code=1, 2, 4, 5	This is a writer software call error. If this error occurs, contact NEC Electronics.
code=3	This error is displayed, if the COM port cannot be automatically recognized or is being used by another application. Make sure that no other application is using the port used for the evaluation board. If this error is still displayed, see 3.2.2 Setting up Applilet EZ PL .
code=7 to 28	This is a write error. Specify a greater value in the Wait field in the Flash Memory Programmer Settings dialog box . However, writing will be slower.
code=33 to 40	This error is displayed if the HEX file is corrupt. If this error occurs, contact NEC Electronics.
code=99	This error indicates that a time out has occurred for write processing due to an error. Check the connections of the power switch, flash rewrite switch, and USB cable, and then re-execute writing. If this error occurs again, contact NEC Electronics.

“The information could not be saved.”

This message is displayed if saving the information specified in the dialog box displayed by selecting a submenu item in the [Settings] menu failed.

[Countermeasure]

The file for saving the information might be corrupt. Uninstall and then reinstall Applilet EZ PL.

“The flash memory programmer is not specified.”

This message is displayed if the flash memory programmer execution file is not specified.

[Countermeasure]

Specify the execution file by selecting the [Settings] menu and then [FLASH memory programmer].

“Running the command failed. (code)”

This message is displayed if the flash memory programmer could not be run.

[Countermeasure]

Check the specified settings by selecting the [Settings] menu and then [FLASH memory programmer] and specify the correct execution file.

APPENDIX A AUTOMATICALLY GENERATED FILES (FOR 78K0/Kx2 AND 78K0R/KE3-L)

A.1 File Structure

Applilet EZ PL automatically generates object code (*.hex) that can be executed in the 78K0/Kx2 or 78K0R/KE3-L by using a compiler after it generates a C language source file (*.c or *.h) for the 78K0 or 78K0R Series based on the information about the assigned panels.

The generated C language source file (*.c or *.h) is stored in the location specified as the destination folder for saving projects in Applilet EZ PL. (A folder that has the name of the panel location file (without the extension) is automatically generated.)

A project file of the integrated development environment platform PM+ (*.prj) is also automatically generated.

Figure A-1. Files Generated by Applilet EZ PL (for 78K0/Kx2 and 78K0R/KE3-L)

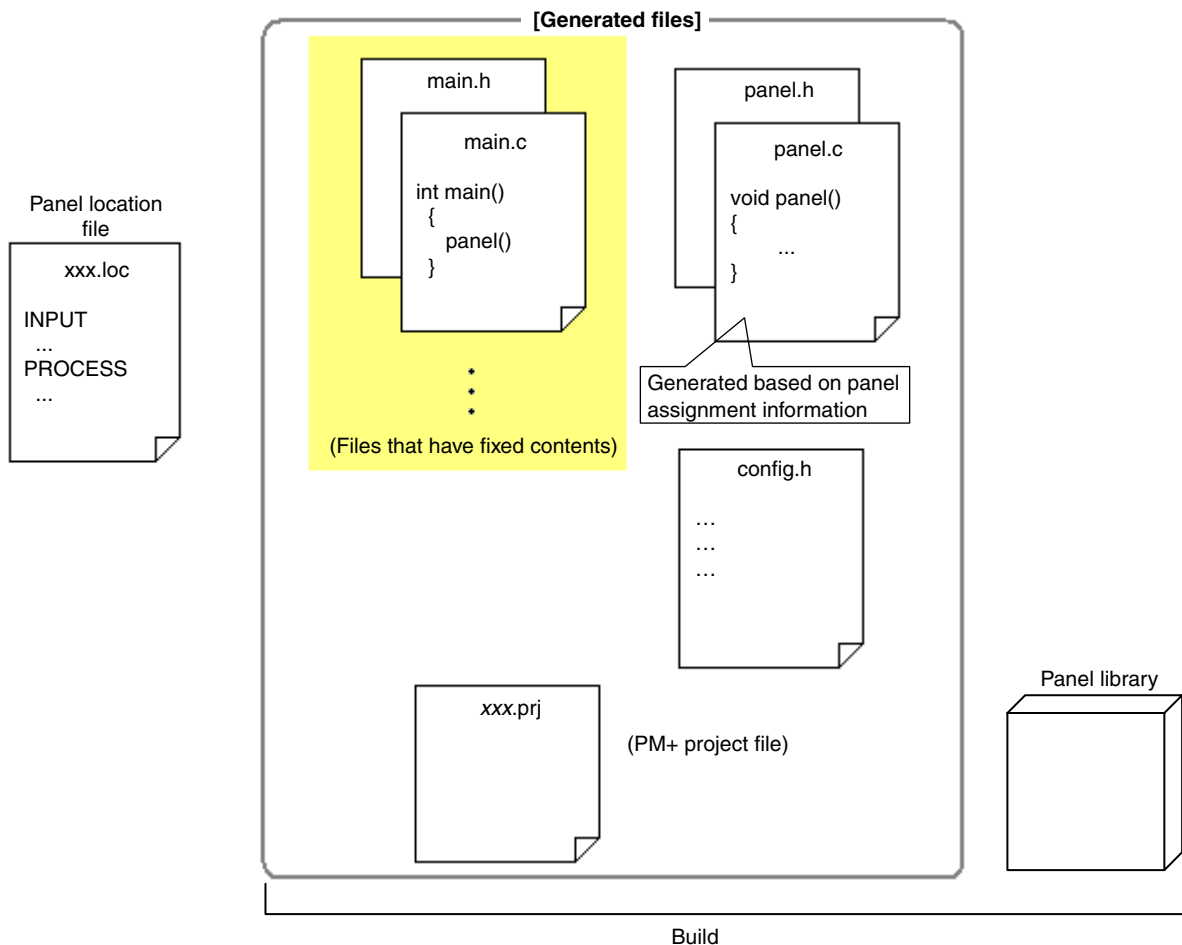

[Caution] The files above are overwritten if object code (*.hex) is generated by Applilet EZ PL. Therefore, when referencing the generated source file, use only the file after copying the folder containing the file to a different location.

Note that NEC Electronics makes no guarantees about the contents of the files generated by Applilet EZ PL.

Applilet EZ PL generates the files below. A library is provided for processing each panel, and Applilet EZ PL generates the code for calling the functions in that library.

(1) Program files (*.c)

Table A-1. Generated Program Files

File Name	Overview
common.c	Code for common processing
int.c	Code for processing related to interrupts
main.c	Code for the main processing for the system
panel.c	Code for panel code
port.c	Code for processing related to port I/O
system.c	Code for processing related to the system
systeminit.c	Code for processing related to initializing the system
timer.c	Code for processing related to timers
watchdogtimer.c	Code for processing related to the watchdog timer

(2) Header files (*.h)

Table A-2. Generated Header Files

File Name	Overview
7seg.h	Definitions of items related to 7-segment LED display
74hc.h	Definitions of items related to the 74 Series logic IC
ad.h	Definitions of items related to A/D converter input
buzzer.h	Definitions of items related to sounding the buzzer
config.h	Definitions of the items specified on the GUI
counter.h	Definitions of items related to counter processing
comp.h	Definitions of items related to comparator processing
delay.h	Definitions of items related to delay processing
digitalio.h	Definitions of items related to digital I/O
flipflop.h	Definitions of items related to flip-flop processing
int.h	Definitions of items related to interrupts
key.h	Definitions of items related to key input
lcd.h	Definitions of items related to LCD display
logic.h	Definitions of items related to logic processing
net.h	Definitions of items related to network processing
panel.h	Definitions of items related to the panel code (panel.c)
port.h	Definitions of items related to port I/O
pwm.h	Definitions of items related to PWM processing

File Name	Overview
serial.h	Definitions of items related to the serial interface
stepmotor.h	Definitions of items related to the step motor
switch.h	Definitions of items related to switch input
system.h	Definitions of items related to the system
timer.h	Definitions of items related to timers
timerpanel.h	Definitions of items related to timer panels
watchdogtimer.h	Definitions of items related to the watchdog timer
web.h	Definitions of items related to WEB I/O

(3) Panel library file

A library file (EZPL78K0KZ2.LIB) for processing each panel is stored in the obj folder and is linked when object code is generated.

(4) PM+ project file (*.prj)

The name of a PM+ project file is “the name of the target panel location file (without the extension) + prj”.

All of the source files and include files above are added to the generated project file as PM+ projects.

PM+ facilitates the sequence of operations in software development, such as running the editor, builder, and debugger. By loading this project file into PM+, software generated by Applilet EZ PL can be studied and evaluated more efficiently.

A.2 Interface

Applilet EZ PL expands calling the processing of panels to panel.c.

The major macros expanded to panel.c are listed below.

For details about the macros, see the **Function and macro interface.pdf** file on the CD. (See page 20 for the file location.)

Table A-3. Macros Expanded to panel.c

Processing	Macro Name	Processing	Macro Name
Digital input	DGIN_INIT0	Sounding the buzzer	BUZZ_INIT0
	DGIN_INIT		BUZZ_INIT
	DGIN_PROC		BUZZ_PROC
	KEY_INIT0	LCD display	LCD2_INIT0
DGOUT_PROC	LCD2_PROC		
Digital output	ANI_PROC	Web output	WEBO_INIT0
Analog input	ANI_OUT		WEBO_PROC
UART6 input	URX6_INIT0	7-segment LED output	SEG_INIT0
	URX6_PROC		SEG_DISP_1
	URX6_OUT		SEG_DISP
UART6 output	UTX6_INIT0	Logic	AND_PROC
	UTX6_PROC		OR_PROC
UART0 input	URX0_INIT0		XOR_PROC
	URX0_PROC		NOT_PROC
	URX0_OUT	Comparator	COMP_INIT0
UART0 output	UTX0_INIT0		COMP_PARAM
	UTX0_PROC		COMP_PROC
Simple PWM output	PULSE_INIT0	Comparator	COMP_INIT0
	PULSE_INIT		COMP_PARAM
	PULSE_PROC		COMP_PROC
PWM output	PWM_INIT0	Flip-flop	JKFF_INIT0
	PWM_INIT		JKFF_INIT
	PWM_PARAM		JKFF_PROC
	PWM_PROC		RSFF2_INIT0
Stepping-motor output	SMOT_INIT0		RSFF2_INIT
	SMOT_INIT		RSFF2_PROC
	SMOT_PROC		TFF2_INIT0
Web input	WEBI_PROC		TFF2_INIT
	WEBI_OUT		TFF2_PROC

Processing	Macro Name	Processing	Macro Name
Flip-flop	DFF2_INIT0	Logic IC	IC74HC30_PROC
	DFF2_INIT		IC74HC51_PROC
	DFF2_PROC		IC74HC77_INIT0
Counter	CNT_INIT0		IC74HC77_INIT
	CNT_INIT		IC74HC77_PROC
	CNT_PROC		IC74HC112_INIT0
	CNT_OUT		IC74HC112_INIT
	BCNT_INIT0		IC74HC112_PROC
	BCNT_INIT		IC74HC112_PROC
	BCNT_PROC		IC74HC133_PROC
Timer	TIMER_INIT0		IC74HC138_PROC
	TIMER_INIT		IC74HC148_PROC
	TIMER_PROC		IC74HC153_PROC
Delay	DELAY_INIT0		IC74HC166_INIT0
	DELAY_INIT		IC74HC166_INIT
	DELAY_PROC	IC74HC166_PROC	
Clock	CLK_INIT0	IC74HC280_PROC	
	CLK_INIT	IC74HC283_PROC	
	CLK_PROC	IC74HC4002_PROC	
Logic IC	IC74HC00_PROC	IC74HC4072_PROC	
	IC74HC02_PROC	IC74HC4075_PROC	
	IC74HC10_PROC	IC74HC4078_PROC	
	IC74HC11_PROC	IC74HC4511_INIT0	
	IC74HC20_PROC	IC74HC4511_INIT	
	IC74HC21_PROC	IC74HC4511_PROC	
	IC74HC27_PROC	IC74HC7266_PRC	

A.2.1 Digital input

DGIN_INIT0	Processing	Initializes digital input.
	Format	DGIN_INIT0 (Active)
	Parameters	Active: Specifies the active level.
	Remark	This processing is executed immediately after the program starts for the assigned number of digital input panels.
DGIN_INIT	Processing	Updates the digital input status.
	Format	DGIN_INIT
	Parameters	None
	Remark	This processing is executed every time the main loop cycle starts.
DGIN_PROC	Processing	Performs digital input.
	Format	DGIN_PROC (Fout, Port, Active, Value, Trig)
	Parameters	Fout: Specifies the variable for storing the digital input value. Port: Number of the port to which digital data is input Active: Specifies the active level. Value: Chattering elimination time (ms units) Trig: Specifies the variable to which the trigger for counting the chattering elimination time is specified (fixed to fTrg 10 ms).
	Remark	The port number is handled as the number that remains when "P" is omitted from the port name. Examples: P01 → 1 P140 → 140
KEY_INIT0	Processing	Initializes key and switch input.
	Format	KEY_INIT0
	Parameters	None
	Remark	This initialization is required for performing chattering processing for keys and switches.

A.2.2 Digital output

DGOUT_PROC	Processing	Outputs digital data.
	Format	DGOUT_PROC (Out, In, Active)
	Parameters	Out: Specifies the number of the port from which digital data is output. In: Specifies the digital output value. Active: Specifies the active level.
	Remark	The port number is handled as the number that remains when "P" is omitted from the port name. Examples: P01 → 1 P140 → 140

A.2.3 Analog input

ANI_PROC	Processing	Inputs analog data.
	Format	ANI_PROC (Ch, Mode)
	Parameters	Ch: Specifies the port to which analog data is input. Mode: Specifies the mode for processing analog input panels. TYPE_COMPARE_VAL_AD: Compare mode TYPE_COMPARE_RANGE_AD: Range specification mode TYPE_BIT_AD: Bit mode
	Remark	–
ANI_OUT	Processing	Extracts the result of analog input.
	Format	ANI_OUT (ValH, ValL, Out)
	Parameters	ValH: Specifies the upper limit of comparison. Specifies the bit position in bit mode. ValL: Specifies the lower limit of comparison. Out: Specifies the variable for storing the result (1 or 0).
	Remark	–

A.2.4 UART6 input

URX6_INIT0	Processing	Initializes UART6 input.
	Format	URX6_INIT0 (B_rate, D_bit, Parity, F_bit)
	Parameters	B_rate: Specifies 1/100 the transfer rate (bps). (Example: Specifies 96 for 9,600 bps.) D_bit: Specifies the number of data bits. Parity: Specifies the parity control method. F_bit: Specifies the stop bit.
	Remark	This processing is executed only once immediately after the program starts.
URX6_PROC	Processing	Inputs data from UART6.
	Format	URX6_PROC (Mode)
	Parameters	Mode: Specifies the panel processing mode. TYPE_COMPARE_VAL: Compare mode TYPE_BIT: Bit mode
	Remark	–
URX6_OUT	Processing	Extracts the data input from UART6.
	Format	URX6_OUT (Val, Out)
	Parameters	Val: Specifies the value to be compared in compare mode. Specifies the bit position at which to extract the data in bit mode. Out: Specifies the variable for storing the result (1 or 0).
	Remark	–

A.2.5 UART6 output

UTX6_INIT0	Processing	Initializes UART6 output.
	Format	UTX6_INIT0 (B_rate, D_bit, Parity, S_bit, F_bit)
	Parameters	B_rate: Specifies 1/100 the transfer rate (bps). (Example: Specifies 96 for 9,600 bps.) D_bit: Specifies the number of data bits. Parity: Specifies the parity control method. F_bit: Specifies the stop bit.
	Remark	–
UTX6_PROC	Processing	Outputs data to UART6.
	Format	UTX6_PROC (Enable, Bit7, Bit6, Bit5, Bit4, Bit3, Bit2, Bit1, Bit0)
	Parameters	Enable: Enables (1) or disables (0) output. Bits 7 to 0: Specifies the output value for each bit.
	Remark	–

A.2.6 UART0 input

URX0_INIT0	Processing	Initializes UART0 input.
	Format	URX0_INIT0 (B_rate, D_bit, Parity, F_bit)
	Parameters	B_rate: Specifies 1/100 the transfer rate (bps). (Example: Specifies 144 for 14,400 bps.) D_bit: Specifies the number of data bits. Parity: Specifies the parity control method. F_bit: Specifies the stop bit.
	Remark	This processing is executed only once immediately after the program starts.
URX0_PROC	Processing	Inputs data from UART0.
	Format	URX0_PROC (Mode)
	Parameters	Mode: Specifies the panel processing mode. TYPE_COMPARE_VAL: Compare mode TYPE_BIT: Bit mode
	Remark	–
URX0_OUT	Processing	Extracts the data input from UART0.
	Format	URX0_OUT (Val, Out)
	Parameters	Val: Specifies the value to be compared in compare mode. Specifies the bit position at which to extract the data in bit mode. Out: Specifies the variable for storing the result (1 or 0).
	Remark	–

A.2.7 UART0 output

UTX0_INIT0	Processing	Initializes UART0 output.
	Format	UTX0_INIT0 (B_rate, D_bit, Parity, S_bit, F_bit)
	Parameters	B_rate: Specifies 1/100 the transfer rate (bps). (Example: Specifies 144 for 14,400 bps.) D_bit: Specifies the number of data bits. Parity: Specifies the parity control method. F_bit: Specifies the stop bit.
	Remark	–
UTX0_PROC	Processing	Outputs data to UART0.
	Format	UTX0_PROC (Enable, Bit7, Bit6, Bit5, Bit4, Bit3, Bit2, Bit1, Bit0)
	Parameters	Enable: Enables (1) or disables (0) output. Bits 7 to 0: Specifies the output value for each bit.
	Remark	–

A.2.8 Simple PWM output

PULSE_INIT0	Processing	Initializes simple PWM output.
	Format	PULSE_INIT0 (DutyMode, OutPort)
	Parameters	DutyMode: Number of output stages (3 or 5) OutPort: Output port number
	Remark	The port number is handled as the number that remains when “P” is omitted from the port name. It is called immediately after the program starts for the number of assigned panels.
PULSE_INIT	Processing	Updates simple PWM output processing.
	Format	PULSE_INIT
	Parameters	None
	Remark	This processing is executed every time the main loop cycle starts.
PULSE_PROC	Processing	Performs simple PWM output.
	Format	PULSE_PROC (In1, In2, In3, In4, In5)
	Parameters	In1: Value input to the 100% input pin In2: Value input to the 75% input pin if the number of output stages is 5 Value input to the 50% input pin if the number of output stages is 3 In3: Value input to the 50% input pin if the number of output stages is 5 Value input to the 0% input pin if the number of output stages is 3 In4: Value input to the 25% input pin if the number of output stages is 5 Fixed to 0 if the number of output stages is 3 In5: Value input to the 0% input pin if the number of output stages is 5 Fixed to 0 if the number of output stages is 3
	Remark	–

A.2.9 PWM output

PWM_INIT0	Processing	Initializes PWM output.
	Format	PWM_INIT0 (OutPort, Freq)
	Parameters	OutPort: Specifies the port that performs PWM output. Freq: Specifies the PWM output frequency.
	Remark	This processing is executed only once immediately after the program starts.
PWM_INIT	Processing	Updates PWM output processing.
	Format	PWM_INIT
	Parameters	None
	Remark	This processing is executed every time the main loop cycle starts.
PWM_PARAM	Processing	Specifies the PWM output parameters.
	Format	PWM_PARAM (Duty, In)
	Parameters	Duty: Specifies the duty factor. In: Enables (1) or disables (0) output.
	Remark	–
PWM_PROC	Processing	Performs PWM output.
	Format	PWM_PROC
	Parameters	None
	Remark	–

A.2.10 Stepping-motor output

SMOT_INIT0	Processing	Initializes stepping-motor output.
	Format	SMOT_INIT0 (OutA, OutB, OutC, OutD, Excit, Speed)
	Parameters	OutA, OutB, OutC, OutD: Output ports Excit: Excitation method Speed: Specifies the rotation speed.
	Remark	–
SMOT_INIT	Processing	Starts processing stepping-motor output.
	Format	SMOT_INIT
	Parameters	None
	Remark	–
SMOT_PROC	Processing	Outputs a signal to the stepping motor.
	Format	SMOT_PROC (Enb, Dir)
	Parameters	Enb: Enables (1) or disables (0) operation. Dir: Specifies the rotation direction.
	Remark	–

A.2.11 Web input

WEBI_PROC	Processing	No processing
	Format	WEBI_PROC
	Parameters	None
	Remark	-
WEBI_OUT	Processing	Performs Web input.
	Format	WEBI_OUT (In, Out)
	Parameters	In: Web input number Out: Specifies the variable for storing the input result.
	Remark	-

A.2.12 Buzzer

BUZZ_INIT0	Processing	Initializes output to the buzzer.
	Format	BUZZ_INIT0 (OutPort)
	Parameters	OutPort: Specifies the output port.
	Remark	-
BUZZ_INIT	Processing	Updates the status of the output to the buzzer.
	Format	BUZZ_INIT
	Parameters	None
	Remark	-
BUZZ_PROC	Processing	Outputs data to the buzzer.
	Format	BUZZ_PROC (In2000, In1000, In500)
	Parameters	In2000: Enables (1) or disables (0) 2,000 Hz output. In1000: Enables (1) or disables (0) 1,000 Hz output. In500: Enables (1) or disables (0) 500 Hz output.
	Remark	-

A.2.13 LCD output

LCD2_INIT0	Processing	Initializes output to the LCD.
	Format	LCD2_INIT0
	Parameters	None
	Remark	–
LCD2_PROC	Processing	Outputs data to the LCD.
	Format	LCD2_PROC (Line, Position, Type, CharNum, String, Enable, in_7, in_6, in_5, in_4, in_3, in_2, in_1, in_0)
	Parameters	Line: Output row position Position: Output digit position Type: Output mode CharNum: Number of digits output String: Character string output Enable: Enabling (1) or disabling (0) of output In_x: Specifies the output value by using a bit.
	Remark	–

A.2.14 7-segment LED output

SEG_INIT0	Processing	Initializes output to the 7-segment LED.
	Format	SEG_INIT0
	Parameters	None
	Remark	–
SEG_DISP	Processing	Displays data for the 7-segment LED.
	Format	SEG_DISP
	Parameters	None
	Remark	Specify the value to display by using a 7-segment display panel.
SEG_DISP_1	Processing	Displays data for the 7-segment LED.
	Format	SEG_DISP_1 (ucSeg)
	Parameters	ucSeg: Data to be output
	Remark	Used in SEG_DISP.

A.2.15 Logic

AND_PROC	Processing	Performs AND processing for the input values.
	Format	AND_PROC (In1, In2, Out)
	Parameters	Stores the logical product of In1 and In2 into Out.
	Remark	–
OR_PROC	Processing	Performs OR processing for the input values.
	Format	ucflg = ORF (In1, In2)
	Parameters	Stores the logical sum of In1 and In2 into Out.
	Remark	–
XOR_PROC	Processing	Performs XOR processing for the input values.
	Format	XOR_PROC (In1, In2, Out)
	Parameters	Stores the exclusive logical sum of In1 and In2 into Out.
	Remark	–
NOT_PROC	Processing	Performs NOT processing for the input value.
	Format	NOT_PROC (In, Out)
	Parameters	Stores the result of In negation into Out.
	Remark	–

A.2.16 Comparator

COMP_INIT0	Processing	Initializes comparator processing.
	Format	COMP_INIT0
	Parameters	None
	Remark	–
COMP_PARAM	Processing	Specifies the value to compare by using the comparator.
	Format	COMP_PARAM (In7, In6, In5, In4, In3, In2, In1, In0)
	Parameters	Specifies the value to compare for each bit.
	Remark	To compare two values, specify two COMP_PARAM rows.
COMP_PROC	Processing	Compares the values.
	Format	COMP_PROC (OutBig, OutEqual, OutSmall)
	Parameters	OutBig: Outputs 1 if A > B. OutEqual: Outputs 1 if A = B. OutSmall: Outputs 1 if A < B.
	Remark	–

A.2.17 Flip-flops

JKFF_INIT0	Processing	Initializes JK-flip-flops.
	Format	JKFF_INIT0 (init)
	Parameters	init: Specifies the initial output value from the Q pin.
	Remark	This processing is executed immediately after the program starts for the number of assigned JK-flip-flop panels.
JKFF_INIT	Processing	Updates the statuses of JK-flip-flops.
	Format	JKFF_INIT
	Parameters	None
	Remark	This processing is executed every time the main loop cycle starts.
JKFF_PROC	Processing	Processes JK-flip-flops.
	Format	JKFF_PROC (Jin, Clk, Kin, Qout, Qout2)
	Parameters	Jin: J input pin Clk: CK input pin Kin: K input pin Qout: Q output pin Qout2: \bar{Q} output pin
	Remark	–
RSFF2_INIT0	Processing	Initializes RS-flip-flops.
	Format	RSFF2_INIT0 (init)
	Parameters	init: Specifies the initial output value from the Q pin.
	Remark	This processing is executed immediately after the program starts for the number of assigned RS-flip-flop panels.
RSFF2_INIT	Processing	Updates the statuses of RS-flip-flops.
	Format	RSFF2_INIT
	Parameters	None
	Remark	This processing is executed every time the main loop cycle starts.
RSFF2_PROC	Processing	Processes RS-flip-flops.
	Format	RSFF2_PROC (Sin, Rin, Out, Out2)
	Parameters	Sin: Set input pin Rin: Reset input pin Out: Q output pin Out2: \bar{Q} output pin
	Remark	This processing is used for RS-flip-flop panels that have two output pins.
TFF2_INIT0	Processing	Initializes T-flip-flops.
	Format	TFF2_INIT0 (init)
	Parameters	init: Specifies the initial output value from the Q pin.
	Remark	This processing is executed immediately after the program starts for the number of assigned T-flip-flop panels.
TFF2_INIT	Processing	Updates the statuses of T-flip-flops.
	Format	TFF2_INIT
	Parameters	None
	Remark	This processing is executed every time the main loop cycle starts.

TFF2_PROC	Processing	Processes T-flip-flops.
	Format	TFF2_PROC (Reset, Tin, Out, Out2)
	Parameters	Reset: Reset input pin Tin: T input pin Out: Q output pin Out2: \bar{Q} output pin
	Remark	This processing is used for T-flip-flop panels that have two output pins.
DFF2_INIT0	Processing	Initializes D-flip-flops.
	Format	DFF2_INIT0 (init)
	Parameters	init: Specifies the initial output value from the Q pin.
	Remark	This processing is executed immediately after the program starts for the number of assigned D-flip-flop panels.
DFF2_INIT	Processing	Updates the statuses of D-flip-flops.
	Format	DFF2_INIT
	Parameters	None
	Remark	This processing is executed every time the main loop cycle starts.
DFF2_PROC	Processing	Processes D-flip-flops.
	Format	DFF2_PROC (Din, Clk, Out, Out2)
	Parameters	Din: Data input pin Clk: Clock input pin Out: Q output pin Out2: \bar{Q} output pin
	Remark	This processing is used for D-flip-flop panels that have two output pins.

A.2.18 Counter

CNT_INIT0	Processing	Initializes the counter.
	Format	CNT_INIT0
	Parameters	None
	Remark	–
CNT_INIT	Processing	Updates the counter.
	Format	CNT_INIT
	Parameters	None
	Remark	–
CNT_PROC	Processing	Counts by using the counter.
	Format	CNT_PROC (In, Reset, Type, Limit)
	Parameters	In: Count clock Reset: Counter reset Type: Counter operating mode Limit: Maximum counter value
	Remark	–

CNT_OUT	Processing	Outputs data to the counter.
	Format	CNT_OUT (Val, Out)
	Parameters	Stores 1 into Out if the count value reaches Val or stores 0 otherwise.
	Remark	–
BCNT_INIT0	Processing	Initializes the binary counter.
	Format	BCNT_INIT0
	Parameters	None
	Remark	This processing is executed only once immediately after the program starts, regardless of the number of assigned binary counter panels.
BCNT_INIT	Processing	Updates the status of the binary counter.
	Format	BCNT_INIT
	Parameters	None
	Remark	This processing is executed every time the main loop cycle starts.
BCNT_PROC	Processing	Counts by using the binary counter.
	Format	BCNT_PROC (max, mr, cp0, cp1, O0, O1, O2, O3)
	Parameters	max: Specifies the maximum value to which to count (BCD: 9, HEX15). mr: MR input pin cp0: C0 input pin cp1: C1 input pin O0: O0 output pin O1: O1 output pin O2: O2 output pin O3: O3 output pin
	Remark	Expresses the count value by using the four bits O0 to O3, with O0 as the LSB.

A.2.19 Timer

TIMER_INIT0	Processing	Initializes the timer.
	Format	TIMER_INIT0
	Parameters	None
	Remark	–
TIMER_INIT	Processing	Initializes the timer.
	Format	TIMER_INIT
	Parameters	None
	Remark	–
TIMER_PROC	Processing	Processes the timer.
	Format	TIMER_PROC (Mode, Sec, MiliSec, In, Out)
	Parameters	Mode: Timer operating mode Sec: Operating time (s) MiliSec: Operating time (ms) In: Panel input Out: Panel output
	Remark	–

A.2.20 Delay

DELAY_INIT0	Processing	Initializes the delay.
	Format	DELAY_INIT0
	Parameters	None
	Remark	–
DELAY_INIT	Processing	Initializes the delay.
	Format	DELAY_INIT
	Parameters	None
	Remark	–
DELAY_PROC	Processing	Processes the delay.
	Format	DELAY_PROC (Sec, MiliSec, In, Out)
	Parameters	Sec: Operating time (s) MiliSec: Operating time (ms) In: Panel input Out: Panel output
	Remark	–

A.2.21 Clock

CLK_INIT0	Processing	Initializes clock panels.
	Format	CLK_INIT0
	Parameters	None
	Remark	This processing is executed only once immediately after the program starts, regardless of the number of assigned clock panels.
CLK_INIT	Processing	Updates the statuses of clock panels.
	Format	CLK_INIT
	Parameters	None
	Remark	This processing is executed every time the main loop cycle starts.
CLK_PROC	Processing	Generates a clock.
	Format	CLK_PROC (Sec, MiliSec, Trig, Out)
	Parameters	Sec: Clock cycle (s) MiliSec: Clock cycle (ms) Trig: Specifies the variable for which the trigger for measuring the clock cycle is specified. Out: Panel output
	Remark	–

A.2.22 Logic IC

IC74HC00_PROC	Processing	2-input NAND 74HC00-compliant processing
	Format	IC74HC00_PROC (A_in, B_in, Y_out)
	Parameters	Outputs the negative logical product of two input signals (A_in and B_in) to Y_out.
	Remark	–
IC74HC02_PROC	Processing	2-input NOR 74HC02-compliant processing
	Format	IC74HC02_PROC (A_in, B_in, Y_out)
	Parameters	Outputs the negative logical sum of two input signals (A_in and B_in) to Y_out.
	Remark	–
IC74HC10_PROC	Processing	3-input NAND 74HC10-compliant processing
	Format	IC74HC10_PROC (A_in, B_in, C_in, Y_out)
	Parameters	Outputs the negative logical product of three input signals (A_in, B_in, and C_in) to Y_out.
	Remark	–
IC74HC11_PROC	Processing	3-input AND 74HC11-compliant processing
	Format	IC74HC11_PROC (A_in, B_in, C_in, Y_out)
	Parameters	Outputs the logical product of three input signals (A_in, B_in, and C_in) to Y_out.
	Remark	–
IC74HC20_PROC	Processing	4-input NAND 74HC20-compliant processing
	Format	IC74HC20_PROC (A_in, B_in, C_in, D_in, Y_out)
	Parameters	Outputs the negative logical product of four input signals (A_in, B_in, C_in, and D_in) to Y_out.
	Remark	–
IC74HC21_PROC	Processing	4-input AND 74HC21-compliant processing
	Format	IC74HC21_PROC (A_in, B_in, C_in, D_in, Y_out)
	Parameters	Outputs the logical product of four input signals (A_in, B_in, C_in, and D_in) to Y_out.
	Remark	–
IC74HC27_PROC	Processing	3-input NOR 74HC27-compliant processing
	Format	IC74HC27_PROC (A_in, B_in, C_in, Y_out)
	Parameters	Outputs the negative logical sum of three input signals (A_in, B_in, and C_in) to Y_out.
	Remark	–

IC74HC30_PROC	Processing	8-input NAND 74H30-compliant processing
	Format	IC74HC30_PROC (A_in, B_in, C_in, D_in, E_in, F_in, G_in, H_in, Y_out)
	Parameters	Outputs the negative logical product of eight input signals (A_in to H_in) to Y_out.
	Remark	–
IC74HC51_PROC	Processing	2/3-input AND-OR-NOT 74HC51-compliant processing
	Format	IC74HC51_PROC (A1_in, B1_in, C1_in, D1_in, E1_in, F1_in, A2_in, B2_in, C2_in, D2_in, Y1_out, Y2_out)
	Parameters	Outputs the negative logical product of the logical sums of both 1A to 1C and 1D to 1F as 1Y, and outputs the negative logical product of the logical sums of both 2A and 2B and 2C and 2D as 2Y.
	Remark	–
IC74HC77_INIT0	Processing	4-bit bistable latch Initializes 74HC77-compliant processing.
	Format	IC74HC77_INIT0
	Parameters	None
	Remark	–
IC74HC77_INIT	Processing	4-bit bistable latch Initializes 74HC77-compliant processing.
	Format	IC74HC77_INIT
	Parameters	None
	Remark	–
IC74HC77_PROC	Processing	4-bit bistable latch 74HC77-compliant processing
	Format	IC74HC77_PROC (D_in, G_in, Q_out)
	Parameters	Supports 74HC77 pins. Individual description is omitted.
	Remark	–
IC74HC112_INIT0	Processing	J-K FF with clear, preset and clock Initializes 74HC112-compliant processing.
	Format	IC74HC112_INIT0
	Parameters	None
	Remark	–
IC74HC112_INIT	Processing	J-K FF with clear, preset and clock Initializes 74HC112-compliant processing.
	Format	IC74HC112_INIT
	Parameters	None
	Remark	–
IC74HC112_PROC	Processing	J-K FF with clear, preset and clock 74HC112-compliant processing
	Format	IC74HC112_PROC (CLR_in, PR_in, J_in, K_in, CK_in, Q_out, invQ_out)
	Parameters	Supports 74HC112 pins. Individual description is omitted.
	Remark	–

IC74HC133_PROC	Processing	13-input NAND 74HC133-compliant processing
	Format	IC74HC133_PROC (A_in, B_in, C_in, D_in, E_in, F_in, G_in, H_in, I_in, J_in, K_in, L_in, M_in, Y_out)
	Parameters	Outputs the negative logical product of 13 input signals (A_in to M_in) to Y_out.
	Remark	–
IC74HC138_PROC	Processing	3 to 8 line decoder 74HC138-compliant processing
	Format	IC74HC138_PROC (G1_in, G2A_in, G2B_in, A_in, B_in, C_in, Y0_out, Y1_out, Y2_out, Y3_out, Y4_out, Y5_out, Y6_out, Y7_out)
	Parameters	Supports 74HC138 pins. Individual description is omitted.
	Remark	–
IC74HC148_PROC	Processing	8 to 3 priority line encoder 74HC148-compliant processing
	Format	IC74HC148_PROC (E0_in, In0_in, In1_in, In2_in, In3_in, In4_in, In5_in, In6_in, In7_in, A0_out, A1_out, A2_out, GS_out, EO_out)
	Parameters	Supports 74HC148 pins. Individual description is omitted.
	Remark	–
IC74HC153_PROC	Processing	4-channel multiplexer 74HC153-compliant processing
	Format	IC74HC153_PROC (G_in, A_in, B_in, C0_in, C1_in, C2_in, C3_in, Y_out)
	Parameters	Supports 74HC153 pins. Individual description is omitted.
	Remark	–
IC74HC166_INIT0	Processing	Initializes 74HC166-compliant processing.
	Format	IC74HC166_INIT0
	Parameters	None
	Remark	–
IC74HC166_INIT	Processing	Initializes 74HC166-compliant processing.
	Format	IC74HC166_INIT
	Parameters	None
	Remark	–
IC74HC166_PROC	Processing	8-bit parallel-in or serial-out shift register 74HC166-compliant processing
	Format	IC74HC166_PROC (CLR_in, SL_in, CK_INH_in, CK_in, S_IN_in, A_in, B_in, C_in, D_in, E_in, F_in, G_in, H_in, QH_out)
	Parameters	Supports 74HC166 pins. Individual description is omitted.
	Remark	–
IC74HC280_PROC	Processing	9-bit parity generator 74HC280-compliant processing
	Format	IC74HC280_PROC (A_in, B_in, C_in, D_in, E_in, F_in, G_in, H_in, I_in, EVEN_out, ODD_out)
	Parameters	Supports 74HC280 pins. Individual description is omitted.
	Remark	–

IC74HC283_PROC	Processing	4-bit binary full adder 74HC283-compliant processing
	Format	IC74HC283_PROC (A1_in, A2_in, A3_in, A4_in, B1_in, B2_in, B3_in, B4_in, C0_in, Q1_out, Q2_out, Q3_out, Q4_out, C4_out)
	Parameters	Supports 74HC283 pins. Individual description is omitted.
	Remark	–
IC74HC4002_PROC	Processing	4-input NOR 74HC4002-compliant processing
	Format	IC74HC4002_PROC (A_in, B_in, C_in, D_in, Y_out)
	Parameters	Supports 74HC4002 pins. Individual description is omitted.
	Remark	–
IC74HC4072_PROC	Processing	4-input OR 74HC4072-compliant processing
	Format	IC74HC4072_PROC (A_in, B_in, C_in, D_in, Y_out)
	Parameters	Outputs the logical sum of four input signals (A_in, B_in, C_in, and D_in) to Y_out.
	Remark	–
IC74HC4075_PROC	Processing	3-input OR 74HC4075-compliant processing
	Format	IC74HC4075_PROC (A_in, B_in, C_in, Y_out)
	Parameters	Outputs the logical sum of three input signals (A_in, B_in, and C_in) to Y_out.
	Remark	–
IC74HC4078_PROC	Processing	8-input OR and NOR 74HC4078-compliant processing
	Format	IC74HC4078_PROC (A_in, B_in, C_in, D_in, E_in, F_in, G_in, H_in, X_out, Y_out)
	Parameters	Outputs the logical sum and negative logical sum of eight input signals (A_in to H_in) to X_out and Y_out, respectively.
	Remark	–
IC74HC4511_INIT0	Processing	BCD to 7-segment latch Initializes 74HC4511-compliant processing.
	Format	IC74HC4511_INIT0
	Parameters	None
	Remark	–
IC74HC4511_INIT	Processing	Initializes 74HC4511-compliant processing.
	Format	IC74HC4511_INIT
	Parameters	None
	Remark	–
IC74HC4511_PROC	Processing	74HC4511-compliant processing
	Format	IC74HC4511_PROC (LE_in, BI_in, LT_in, A_in, B_in, C_in, D_in, a_out, b_out, c_out, d_out, e_out, f_out, g_out)
	Parameters	Supports 74HC280 pins. Individual description is omitted.
	Remark	–

IC74HC7266_PROC	Processing	2-input XNOR 74HC7266-compliant processing
	Format	IC74HC7266_PROC (A_in, B_in, Y_out)
	Parameters	Supports 74HC7266 pins. Individual description is omitted.
	Remark	-

APPENDIX B AUTOMATICALLY GENERATED FILES (FOR 78K0S/Kx1+)

B.1 File Structure

Applilet EZ PL generates assembly source and include files for the 78K0S Series based on the information about the assigned panels and automatically generates object code (*.hex) that can be executed in the 78K0S/Kx1+ by using an assembler.

The assembly source file is generated by Applilet EZ PL and stored in the folder specified by selecting the [Settings] menu and then a project file in the [Saved Data Folder dialog box](#).

Figure B-1. Files Generated by Applilet EZ PL (for 78K0S/Kx1+)

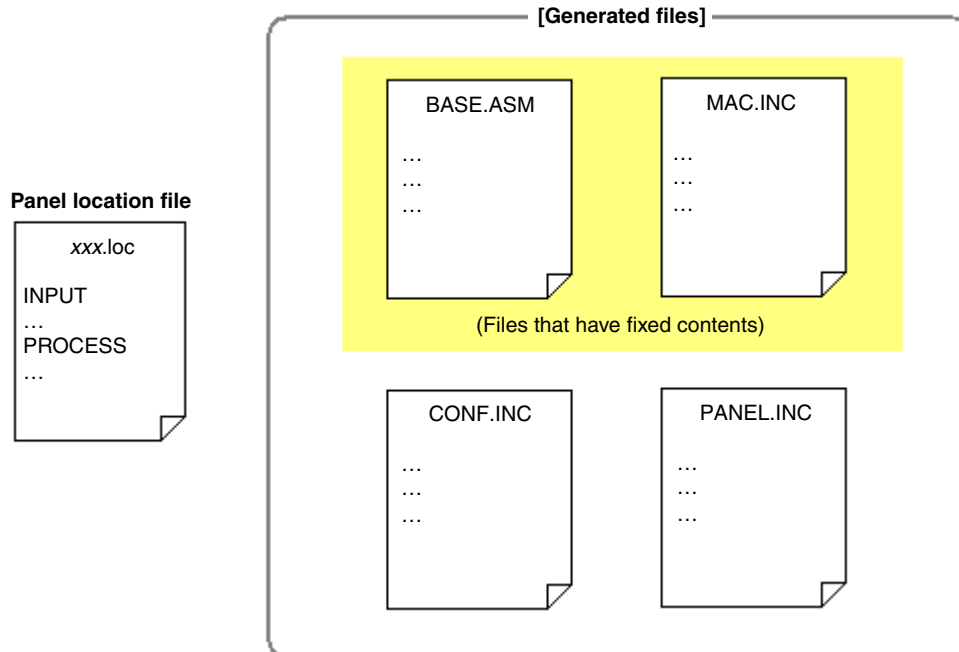

- CONF.INC: File that includes the parameters and definitions for specifying the microcontroller operation
- MAC.INC: Assembly language macro file
- PANEL.INC: Assembly source file generated from panel information
- BASE.ASM: Assembly language file used as the basis for generating an object file

[Caution] The files above are overwritten if object code (*.hex) is generated by Applilet EZ PL. Therefore, when referencing the generated source file, use only the file after copying the folder containing the file to a different location.

Note that NEC Electronics makes no guarantees about the contents of the files generated by Applilet EZ PL.

APPENDIX C EXAMPLE OF THE 7-SEGMENT LED CONNECTION CIRCUIT IN THE 78K0/KE2 AND 78K0/KF2

To install a 7-segment LED in the 78K0/KE2 or 78K0/KF2, connect the 7-segment LED according to the following circuit example.

Figure C-1. Example of a 7-Segment LED Connection Circuit

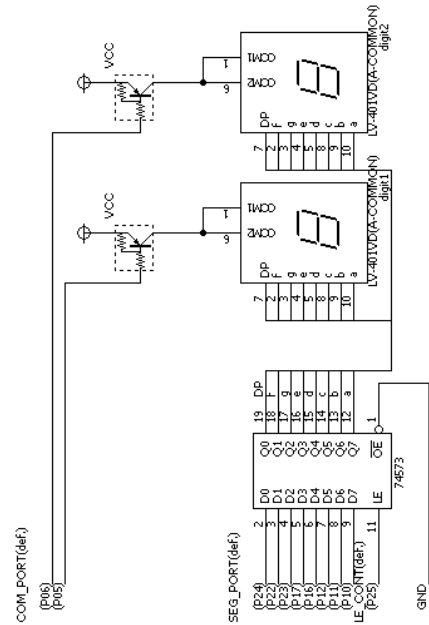

APPENDIX D INDEX

[I]

[Common] tab ... 42, 49
[Other I/Os] tab ... 42, 53
[TK-78K0/KC2L I/Os] ... 46, 53
[TK-78K0R/KE3L I/Os] ... 46, 53

[7]

7-segment LED jumper entrance ... 58
7-segment LED jumper exit ... 53, 54

[A]

A/D converter ... 43, 49
AND operation ... 55
assembler ... 16
Automatically generating object code ... 35, 67

[B]

BASE.ASM ... 161
Build area ... 41

[C]

C compiler ... 16
CC78K0 ... 16
CC78K0R ... 16
CC78K0S ... 16
Ceramic clock ... 123
chattering protection ... 43, 46, 47, 48
Closing Applilet EZ PL ... 29
COM port ... 37, 73, 132
CONF.INC ... 161
Crystal clock ... 123

[D]

duty factor ... 93

[E]

Editing area ... 40
Editing panels ... 63
 Assigning panels from the pallet ... 63
 Changing the panel size ... 65
 Clearing all panels ... 66
 Copying, cutting, and pasting panels ... 63
 Deleting panels ... 64
 Displaying information about the corresponding
 jumpers ... 66
 Moving panels ... 64

 Repeatedly assigning panels ... 63
 Rotating panels ... 65
 Selecting multiple panels ... 63
 Shifting panels horizontally ... 65
 Shifting panels vertically ... 65
 Specifying properties ... 65
 Undoing ... 66

Error messages ... 135
Estimated amount of used ROM ... 75
evaluation board ... 16
External clock ... 123

[F]

Flash Memory Programmer Settings dialog box ...
 131
Flash writing ... 35
folder structure ... 20

[G]

Generating ... 35, 67

[H]

Help area ... 41
Host ... 15

[I]

Input block area ... 40
Input panels ... 42
Install ... 18
Install the USB driver ... 23
Internal oscillator ... 122

[M]

MAC.INC ... 161
Main window ... 39
 Automatically generating object code ... 67
 Editing area ... 40
 Editing panels ... 63
 Menu bar ... 70
 Panel functions... 42
 Right-click menu ... 69
 Saving and reading data ... 67
 Status bar ... 75
 Toolbar ... 74
 Writing to flash memory ... 67
Menu bar ... 70

[N]

NOT operation ... 56

[O]

Object code (*.hex) ... 35, 67
 Operating Environment ... 15
 Operation Procedure ... 31
 Automatically generating object code ... 35
 Editing panels ... 32
 Selecting the target CPU ... 31
 Simulation ... 33
 Writing to the 78K0/Kx2, 78K0S/Kx1+, 78K0R/KE3-L, or 78K0/KC2-L ... 35
 OR operation ... 56
 Output block area ... 40
 Output panels ... 49

[P]

Pallet ... 39
 Panel functions ... 42
 panel location file (*.loc) ... 35, 67, 70
 PANEL.INC ... 161
 Panels
 7-segment display ... 53, 54
 7-segment LED jumper ... 58
 Analog input ... 43
 Analog input (illuminance) ... 49
 Binary counter ... 59
 Buzzer ... 54
 Clock ... 60
 Comparator ... 56
 Counter ... 59
 Delay ... 60
 Digital input ... 43
 Digital output ... 50
 DIP switch ... 47, 48
 Flip-flop ... 59
 Jumper ... 55
 Logic ... 55, 56
 LVI ... 45
 Musical-scale output ... 52
 NC ... 55
 Push button ... 46
 PWM output ... 50
 Reset ... 61
 Simple PWM ... 50
 Step motor ... 52
 Stepping motor ... 61

Timer ... 60
 UART0 input ... 44
 UART0 jumper output ... 57
 UART0 output ... 51
 UART1 input ... 45
 UART1 output ... 51
 UART6 input ... 44
 UART6 jumper output ... 57
 UART6 output ... 51
 Wiring ... 55
 Port Setting dialog box ... 120
 Processing block area ... 40
 Processing panels ... 54
 Program development overview ... 14
 programming elements ... 30
 project file (*.prj) ... 141
 Property Settings dialog box ... 76
 7-segment display ... 102
 7-segment LED jumper (bit type) ... 110
 7-segment LED jumper (digit type) ... 108
 7-segment LED jumper (segment type) ... 109
 Analog input ... 82
 Analog input (illuminance) ... 90
 Binary counter ... 113
 Buzzer ... 101
 Clock ... 116
 Comparator ... 105
 Counter ... 112
 Delay ... 115
 Digital input ... 81
 Digital output ... 91
 DIP switch ... 89
 Flip-flop ... 111
 Jumper ... 104
 LVI ... 87
 Musical-scale output ... 100
 Push button ... 88
 PWM output ... 93
 Reset ... 119
 Simple PWM ... 92
 Step motor ... 97
 Stepping motor ... 117
 Timer ... 114
 UART0 input ... 85
 UART0 jumper output ... 107
 UART0 output ... 95
 UART1 input ... 86
 UART1 output ... 96

- UART6 input ... 84
 - UART6 jumper output ... 106
 - UART6 output ... 94
- [R]**
- RA78K0 ... 16
 - RA78K0R ... 16
 - RA78K0S ... 16
 - Reading ... 67
 - Right-click menu ... 69
 - Rotate ... 54
- [S]**
- Saved Data Folder dialog box ... 133
 - Saving ... 67
 - shortcut icon ... 21
 - Simulation ... 13
 - Simulation area ... 41
 - Starting Applilet EZ PL ... 29
 - Stepping motor ... 117
 - System Components ... 15
- [T]**
- Target CPU Settings dialog box ... 122
 - Toolbar ... 74
 - Truth values for binary counter operations ... 113
 - Truth values for each flip-flop operation ... 111
- [U]**
- UART transmission jumper entrance ... 57
 - UART0 Settings dialog box ... 125
 - UART1 Settings dialog box ... 127
 - UART6 Settings dialog box ... 129
 - Uninstall ... 21
- [W]**
- Watchdog Timer Setting dialog box ... 124
 - Window reference ... 37
 - Flash Memory Programmer Settings dialog box ... 131
 - Main window ... 39
 - Port Setting dialog box ... 120
 - Property Settings dialog box ... 76
 - Saved Data Folder dialog box ... 133
 - Target CPU Settings dialog box ... 122
 - UART0 Settings dialog box ... 125
 - UART1 Settings dialog box ... 127
 - UART6 Settings dialog box ... 129
 - Watchdog Timer Setting dialog box ... 124
 - Windows [Start] menu ... 21
 - Writing to flash memory ... 67
- [X]**
- XOR operation ... 56

*For further information,
please contact:*

NEC Electronics Corporation
1753, Shimonumabe, Nakahara-ku,
Kawasaki, Kanagawa 211-8668,
Japan
Tel: 044-435-5111
<http://www.necel.com/>

[America]

NEC Electronics America, Inc.
2880 Scott Blvd.
Santa Clara, CA 95050-2554, U.S.A.
Tel: 408-588-6000
800-366-9782
<http://www.am.necel.com/>

[Europe]

NEC Electronics (Europe) GmbH
Arcadiastrasse 10
40472 Düsseldorf, Germany
Tel: 0211-65030
<http://www.eu.necel.com/>

Hanover Office

Podbielskistrasse 166 B
30177 Hannover
Tel: 0 511 33 40 2-0

Munich Office

Werner-Eckert-Strasse 9
81829 München
Tel: 0 89 92 10 03-0

Stuttgart Office

Industriestrasse 3
70565 Stuttgart
Tel: 0 711 99 01 0-0

United Kingdom Branch

Cygnus House, Sunrise Parkway
Linford Wood, Milton Keynes
MK14 6NP, U.K.
Tel: 01908-691-133

Succursale Française

9, rue Paul Dautier, B.P. 52
78142 Velizy-Villacoublay Cédex
France
Tel: 01-3067-5800

Sucursal en España

Juan Esplandiu, 15
28007 Madrid, Spain
Tel: 091-504-2787

Tyskland Filial

Täby Centrum
Entrance S (7th floor)
18322 Täby, Sweden
Tel: 08 638 72 00

Filiale Italiana

Via Fabio Filzi, 25/A
20124 Milano, Italy
Tel: 02-667541

Branch The Netherlands

Steijgerweg 6
5616 HS Eindhoven
The Netherlands
Tel: 040 265 40 10

[Asia & Oceania]

NEC Electronics (China) Co., Ltd

7th Floor, Quantum Plaza, No. 27 ZhiChunLu Haidian
District, Beijing 100083, P.R.China
Tel: 010-8235-1155
<http://www.cn.necel.com/>

Shanghai Branch

Room 2509-2510, Bank of China Tower,
200 Yincheng Road Central,
Pudong New Area, Shanghai, P.R.China P.C:200120
Tel:021-5888-5400
<http://www.cn.necel.com/>

Shenzhen Branch

Unit 01, 39/F, Excellence Times Square Building,
No. 4068 Yi Tian Road, Futian District, Shenzhen,
P.R.China P.C:518048
Tel:0755-8282-9800
<http://www.cn.necel.com/>

NEC Electronics Hong Kong Ltd.

Unit 1601-1613, 16/F., Tower 2, Grand Century Place,
193 Prince Edward Road West, Mongkok, Kowloon, Hong Kong
Tel: 2886-9318
<http://www.hk.necel.com/>

NEC Electronics Taiwan Ltd.

7F, No. 363 Fu Shing North Road
Taipei, Taiwan, R. O. C.
Tel: 02-8175-9600
<http://www.tw.necel.com/>

NEC Electronics Singapore Pte. Ltd.

238A Thomson Road,
#12-08 Novena Square,
Singapore 307684
Tel: 6253-8311
<http://www.sg.necel.com/>

NEC Electronics Korea Ltd.

11F., Samik Lavied'or Bldg., 720-2,
Yeoksam-Dong, Kangnam-Ku,
Seoul, 135-080, Korea
Tel: 02-558-3737
<http://www.kr.necel.com/>