

User Manual

DA9318 Evaluation Board

UM-PM-021

Abstract

This document describes the hardware and software used to evaluate the DA9318 evaluation board.

DA9318 Evaluation Board

Contents

Abstract	1
Contents	2
Figures	2
1 Terms and Definitions	3
2 References	3
3 Introduction	4
4 Evaluation Board Hardware	6
4.1 Default Link Positions and Connector Definitions	8
4.2 USB Interface.....	10
4.2.1 USB Power and GUI Reset	10
4.3 Power Supplies	11
4.4 Output Current Sense	11
5 Evaluation Board Software	12
5.1 GUI Installation.....	12
5.1.1 GUI Installation Step By Step Guide	12
5.2 Initial USB Connection	16
6 GUI Software	17
6.1 Controls.....	17
6.2 Control Windows	18
6.2.1 Enable/Disable Polling.....	18
6.2.2 Raw I/O	18
6.2.3 Interface Control Information	18
6.3 ADC Plotter	19
6.4 Quick Start Guide.....	19
Revision History	20

Figures

Figure 1: DA9318 Evaluation Board.....	5
Figure 2: Functional Sections	7
Figure 3: Default Link Positions.....	8
Figure 4: USB Interface Connector and Reset Switch	11
Figure 5: External Output Current Sense Circuit.....	11
Figure 6: GUI Setup Wizard	12
Figure 7: GUI Setup License Agreement	13
Figure 8: GUI Setup Destination Location	13
Figure 9: GUI Setup Start Menu Location	14
Figure 10: GUI Setup Additional Tasks	14
Figure 11: GUI Setup Start Installation.....	15
Figure 12: GUI Setup Finish and Launch	15
Figure 13: Main GUI Interface	17
Figure 14: Polling.....	18
Figure 15: Raw I/O	18
Figure 16: Interface Control Information.....	18

DA9318 Evaluation Board**1 Terms and Definitions**

BOM	Bill Of Materials
CRC	Cyclical Redundancy Check
DUT	Device Under Test
GUI	Graphical User Interface
GUID	Globally Unique IDentifier
HW	HardWare
INI	INItialization
LED	Light Emitting Diode
LS	Level Shifter
OTP	One Time Programmable
PC	Personal Computer
PCB	Printed Circuit Board
PCM	Power Commander Mode
PMIC	Power Management IC
PVC	Power Voltage Converter
SAM3U	USB I ² C Interface
TCP	Transmission Control Protocol
USB	Universal Serial Bus

2 References

- [1] DA9318 Datasheet, Dialog Semiconductor
- [2] 329-01-B1_SCH.pdf, Dialog Semiconductor

DA9318 Evaluation Board

3 Introduction

The DA9318 evaluation board, see [Figure 1](#), facilitates the measurement, evaluation, and programming of DA9318.

Dialog's control software package [SmartCanvas™](#) uses a simple graphical user interface which enables DA9318 to be controlled via the USB port of a PC. The mini USB connection is visible on the left side of the board. When the cable is connected to the USB port of the PC the green LED (D1) is on.

The board contains jumper links, see [Figure 3](#), to provide access to alternative configurations and measurement test points. Most standard operating modes are evaluated with minimal link changes.

DA9318 Evaluation Board

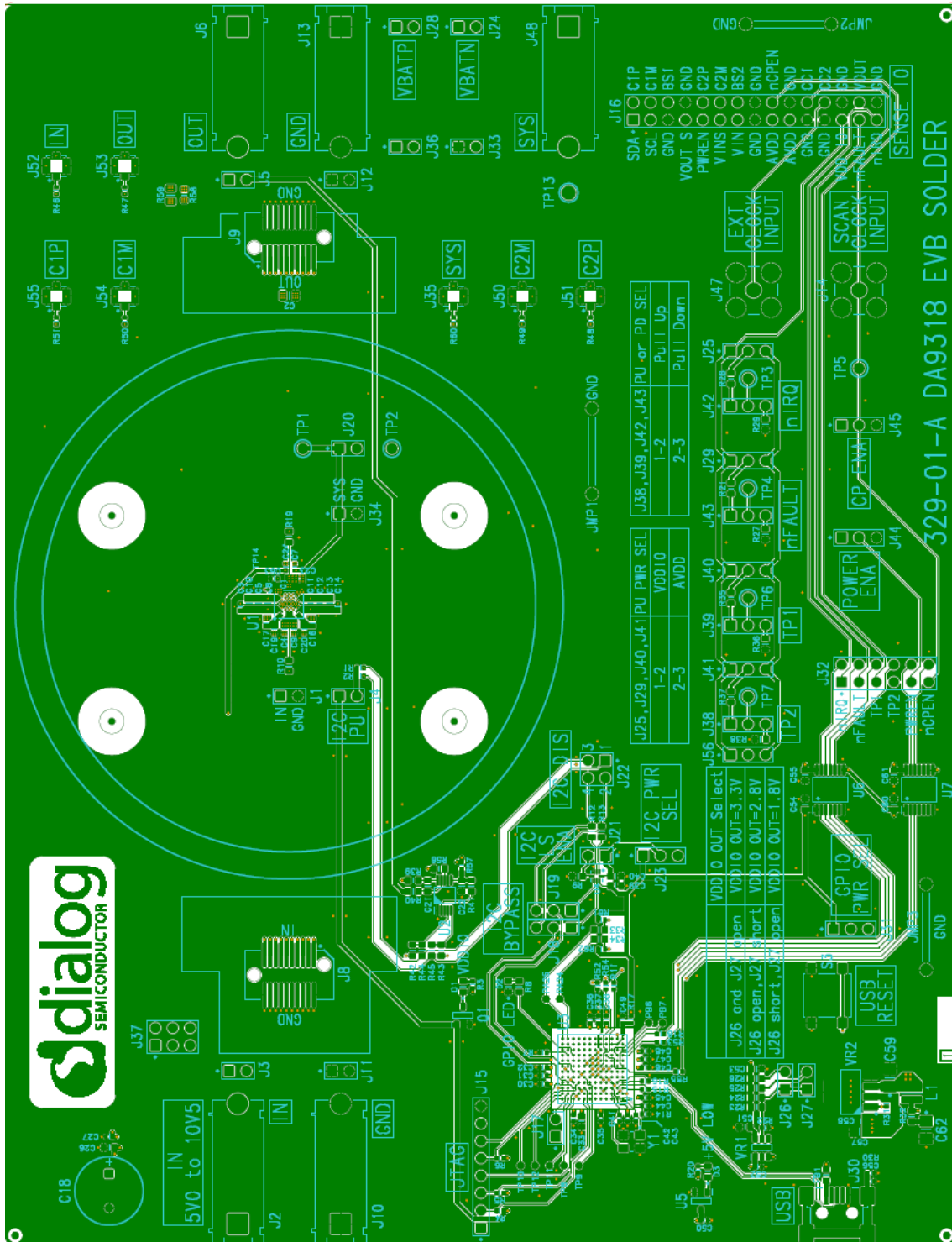

Figure 1: DA9318 Evaluation Board

UM-PM-021

DA9318 Evaluation Board

4 Evaluation Board Hardware

The DA9318 evaluation board functionality can be broken down into sections, see

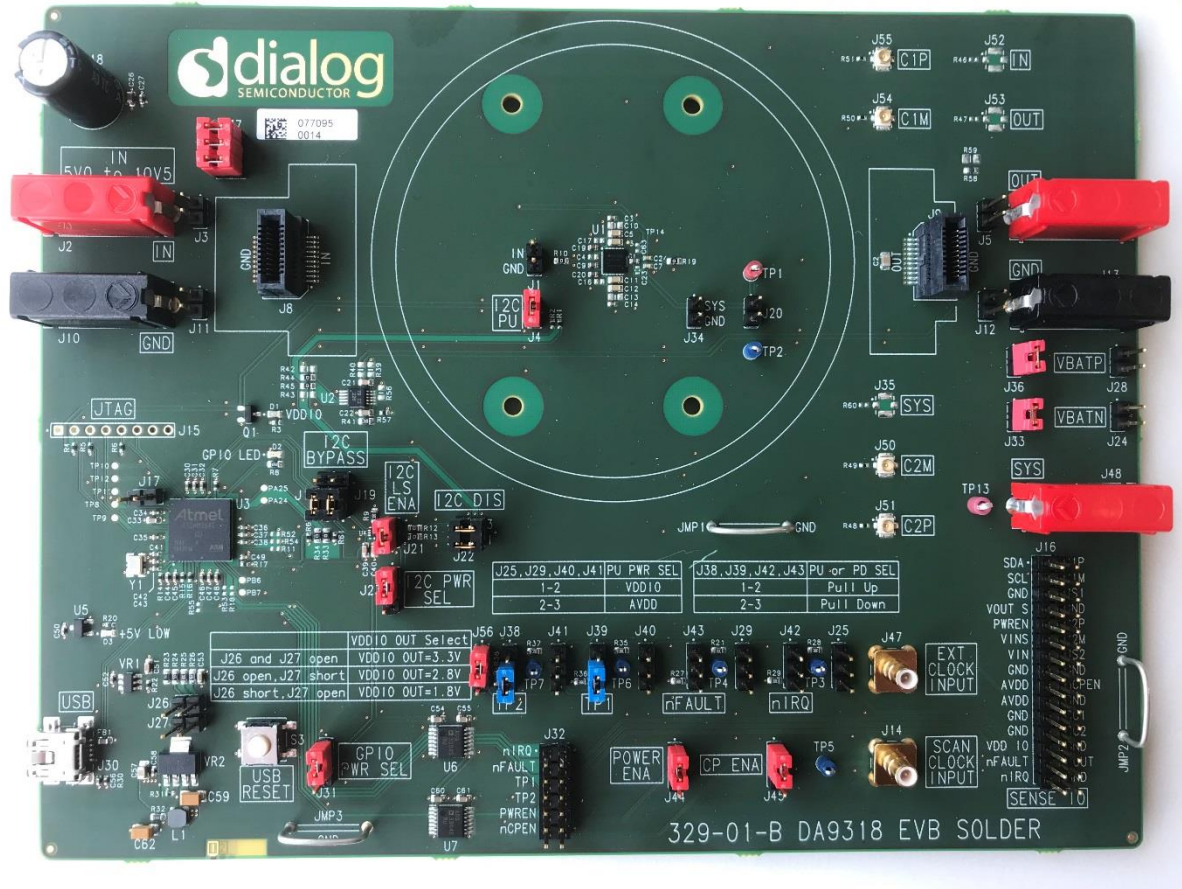

Figure 2:

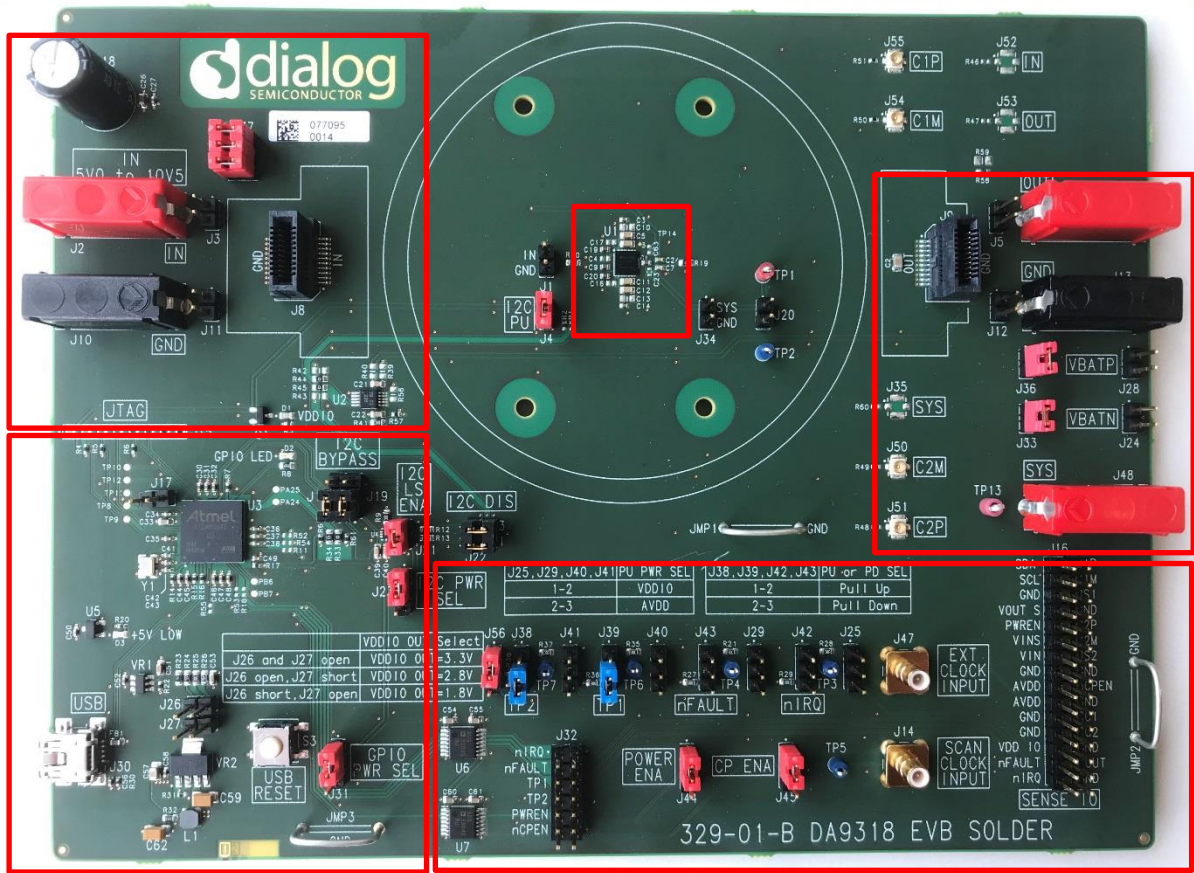

Figure 2: Functional Sections

- IN input power
- DA9318 device and critical components
- Current doubler output and SYS input
- USB interface (I2C communication) and USB reset
- Digital input and output signals, and sense IOs

UM-PM-021

DA9318 Evaluation Board

4.1 Default Link Positions and Connector Definitions

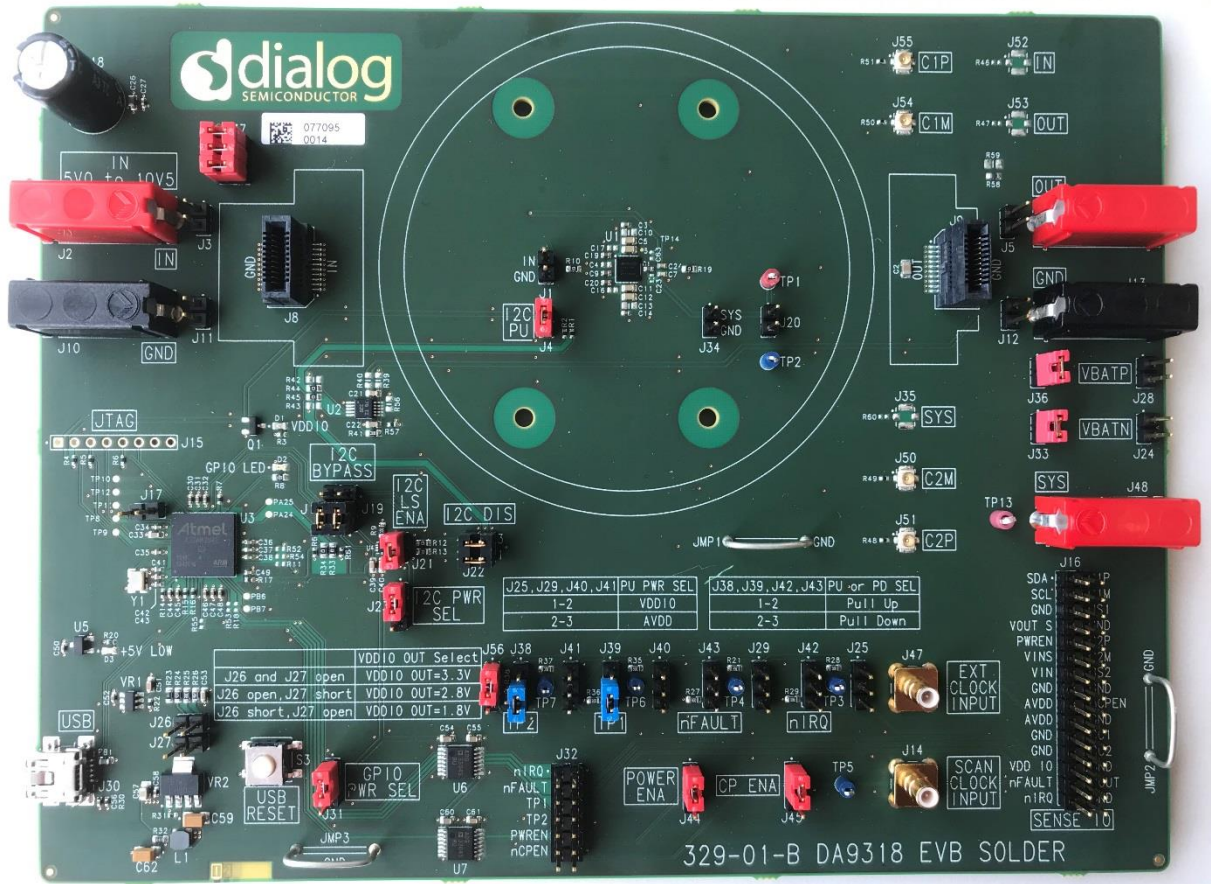

Figure 3: Default Link Positions

Table 1: Default Link Positions and Connector Definitions

Reference Designator	Position	Function
J1	1	IN sense point
	2	GND sense point
J2	NA	IN connector
J3	NA	IN connector
J4	1-2	I ² C pull-up to VDD_IO
J5	NA	OUT connector
J6	NA	OUT connector
J8	NA	Line transient connector
J9	NA	OUT load transient connector
J10	NA	GND connector (IN side of board)
J11	NA	GND connector (IN side of board)
J12	NA	GND connector (OUT side of board)
J13	NA	GND connector (OUT side of board)
J14	NA	NA
J15	NA	JTAG: reserved

DA9318 Evaluation Board

Reference Designator	Position	Function
J16	NA	Measurement header
J17	1-2 (Open)	Important: This erases the USB IC firmware. DO NOT SHORT
J18	1-2 (Default)	I ² C bypass: SAMU3U SCL connected to LS input
	2-3	I ² C bypass: SAMU3U SCL connected to LS output (bypass)
J19	1-2 (Default)	I ² C bypass: SAMU3U SDA connected to LS input
	2-3	I ² C bypass: SAMU3U SDA connected to LS output (bypass)
J20	Installed	Short PWREN to SYS, DA9318 will immediately go from NO-POWER mode to SHUTDOWN mode when SYS power is supplied.
J21	1-2 (Default)	I ² C level shifter IC enabled
J22	1-2	SCL from SAM3U connected to DA9318
	3-4	SDA from SAM3U connected to DA9318
J23	1-2 (Default)	I ² C LS power selection: connected to VDD_IO
	2-3	I ² C LS power selection: connected to AVDD
J24	NA	VBATN connector for cell sensing
J25	1-2	nIRQ PU selection: VDD_IO
	2-3	nIRQ PU selection: AVDD
J26	1-2 (Open)	Sets VDD_IO to 1.8 V (if J27 open) [Default - UNPOP]
J27	1-2 (Open)	Sets VDD_IO to 2.8 V (if J26 open) [Default - UNPOP]
J28	NA	VBATP connector for cell sensing
J29	1-2	nFAULT PU selection: VDD_IO
	2-3	nFAULT PU selection: AVDD
J30	NA	USB inlet
J31	1-2 (Default)	Both sides of level shifter set to VDD_IO
	2-3	Level shift from AVDD to VDD_IO
J32	1-2	nIRQ connected to level shifter and SAM3U
	3-4	nFAULT connected to level shifter and SAM3U
	5-6	CC1 connected to level shifter and SAM3U
	7-8	CC2 connected to level shifter and SAM3U
	9-10	PWREN connected to level shifter and SAM3U
	11-12	nCPEN connected to level shifter and SAM3U
J33	Installed	Short GND to VBATN for a local pack sensing
	Open	GND and VBATN disconnected to allow cell sensing
J34	1	SYS sense point
	2	GND sense point
J35	NA	SMA connector for measuring SYS
J36	Installed	Short VOUT_DA9318 to VBATP for a local pack sensing
	Open	VOUT_DA9318 and VBATP disconnected to allow cell sensing
J37	1-2, 3-4, 5-6 (Close)	IN connector shunt to IN of DA9318
J38	1-2	CC2 (labeled as TP2) pulled up to rail selected by J41

DA9318 Evaluation Board

Reference Designator	Position	Function
	2-3 (Default)	CC2 (labeled as TP2) pulled to ground
J39	1-2	CC1 (labeled as TP1) pulled up to rail selected by J40
	2-3 (Default)	CC1 (labeled as TP1) pulled to ground
J40	1-2	CC1 (labeled as TP1) PU selection: VDD_IO
	2-3	CC1 (labeled as TP1) PU selection: AVDD
J41	1-2	CC2 (labeled as TP2) PU selection: VDD_IO
	2-3	CC2 (labeled as TP2) PU selection: AVDD
J42	1-2	nIRQ pulled up to rail selected by J25
	2-3	nIRQ pulled to ground
J43	1-2	nFAULT pulled up to rail selected by J29
	2-3	nFAULT pulled to ground
J44	1-2 (Default)	NA, do not install
	2-3	Connect PWREN to GND to enter NO-POWER mode. Make sure J20 is open before installing a jumper in this position.
J45	1-2 (Default)	nCPEN shorted to AVDD
	2-3	nCPEN shorted to GND
J47	NA	NA
J48	NA	SYS connector
J50	NA	SMA connector for measuring C2N (labeled as C2M)
J51	NA	SMA connector for measuring C2P
J52	NA	SMA connector for measuring IN
J53	NA	SMA connector for measuring OUT
J54	NA	SMA connector for measuring C1N (labeled as C1M)
J55	NA	SMA connector for measuring C1P
J56	1-2 (Default)	Both sides of level shifter set to VDD_IO
	2-3	Level shift from AVDD to VDD_IO
S3	NA	Push button to reset the USB IC

4.2 USB Interface

The DA9318 evaluation board uses an ATMEL® SAM3U® microcontroller as the USB transceiver; programmed to deliver the following functionalities:

- I²C control interfaces
- discrete digital IO control (General Purpose Input Output (GPIO) and dedicated functions)

4.2.1 USB Power and GUI Reset

The USB is powered by an on-board regulator (VR2), see [Figure 4](#). Pressing the USB RESET switch S3 shuts down the on-board regulator VR2, powering down the supply for the SAM3U (USB I²C interface). This resets the GUI communication with the evaluation board.

DA9318 Evaluation Board

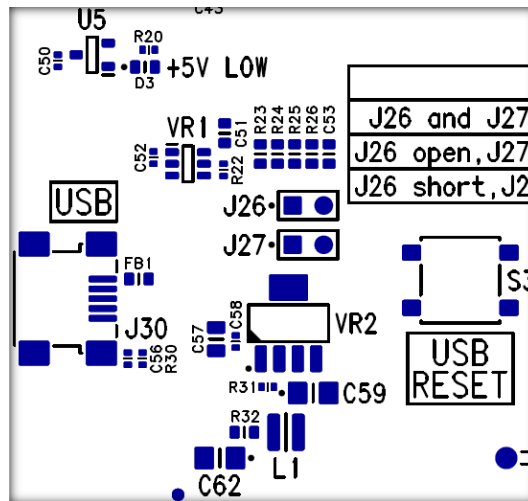

Figure 4: USB Interface Connector and Reset Switch

4.3 Power Supplies

The DA9318 evaluation board is powered up when a power source is connected to SYS (J48) and/or IN (J2). SYS operating voltage range is +2.5 V to +5.5 V and IN operating voltage range is 5.5 V to 10.5 V.

The VDD_IO voltage is generated by an on-board regulator (VR1) supplied from the +5 V USB. By default, the on-board generated VDD_IO is +3.3 V (J26 and J27 jumpers are UNPOP):

- to change the on-board VDD_IO to +1.8 V, J26 must be fitted while J27 is UNPOP
- to change the on-board VDD_IO to +2.8 V, J27 must be fitted while J26 is UNPOP

NOTE

For correct operation, connect the evaluation board to a USB port capable of supplying 500 mA.

4.4 Output Current Sense

The DA9318 evaluation board comes with an external current sense circuit, see Figure 5, for measuring the current flowing from the current doubler to the battery. The current sense circuit is configured for a 7-bit slave address of 0x41. When using I_{OUT} information reported by DA9318, this circuit can be ignored and a short can be installed in place of resistor R59.

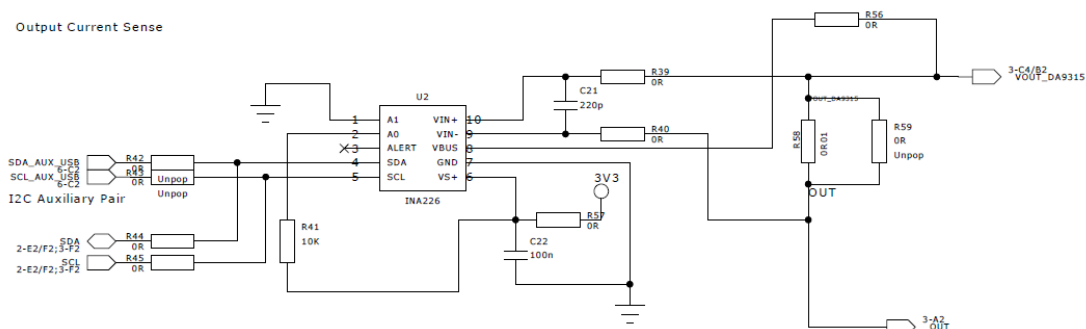

Figure 5: External Output Current Sense Circuit

DA9318 Evaluation Board

5 Evaluation Board Software

The board is controlled using a graphical user interface (GUI), which requires a PC operating Windows® 2000/XP/Vista/Windows 7 with a USB1.1 or USB2 interface. The GUI allows the user to:

- Perform raw write and read operations to all control registers on Dialog and non-Dialog ICs.
- Poll the DA9318 registers.
- Read ADC data from DA9318 (V_{IN} , V_{BAT} , I_{IN} , I_{OUT} , T_{JUNC} , V_{OUT}).
- Send default settings.
- Read all registers displayed.

5.1 GUI Installation

The files required to install the software are available on the supplied USB drive. To install the DA9318 evaluation board software:

1. Run **Setup_DA9318_Evaluation_Board_GUI.x.x.x.xx.exe**.
2. On completion, insert the USB cable and apply V_{SYS} and V_{IN} .
 - a. For first time users Windows should detect the attached USB device. If this is not the case, it may be necessary to install the driver by navigating to the required driver file in the USB driver directory, see section 5.2. After installing the driver, reboot the PC to ensure correct operation.
3. Start the software by running **DA9318_Evaluation_Board.exe**.

5.1.1 GUI Installation Step By Step Guide

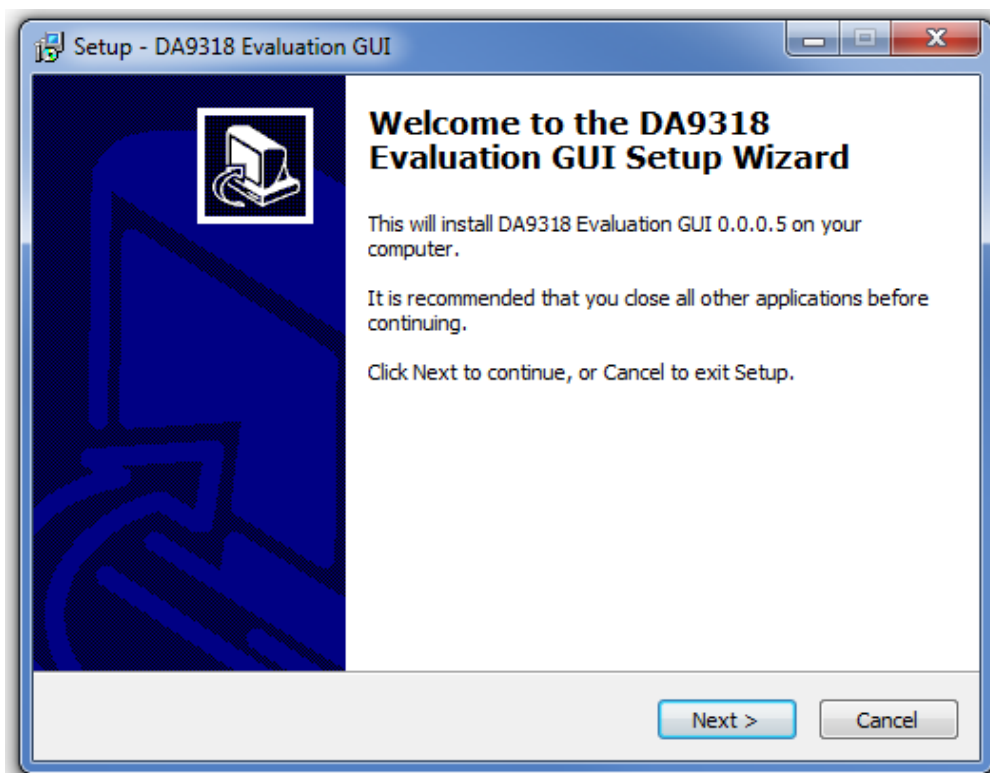

Figure 6: GUI Setup Wizard

1. Click **Next**.

DA9318 Evaluation Board

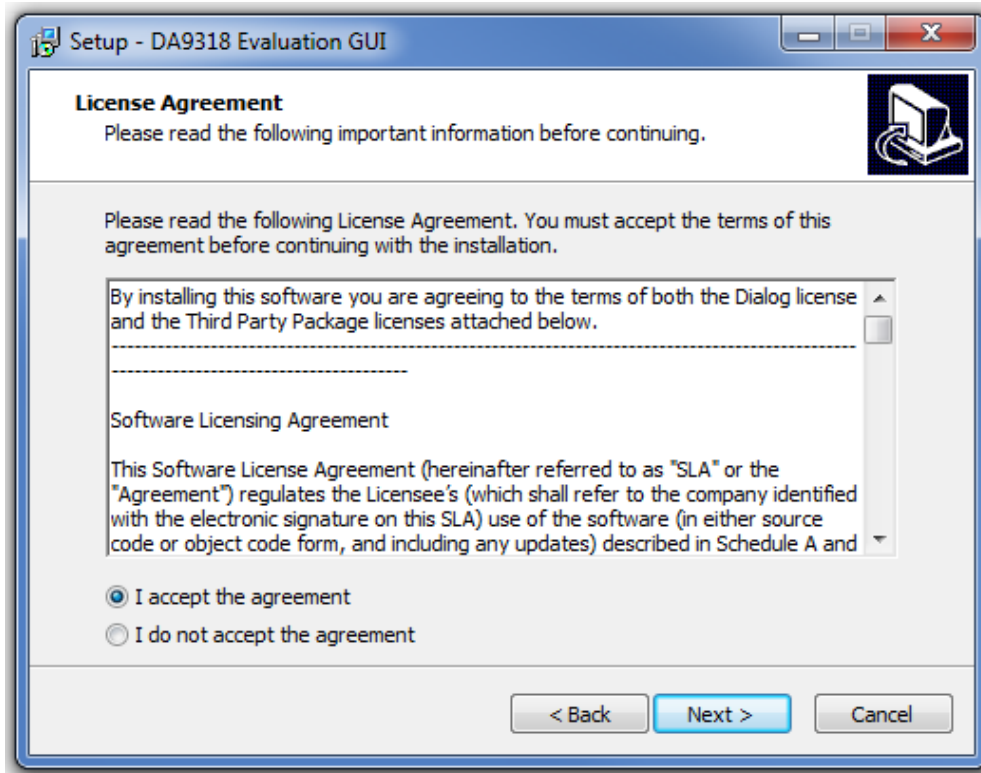

Figure 7: GUI Setup License Agreement

2. Select **I accept the agreement** then click **Next**.

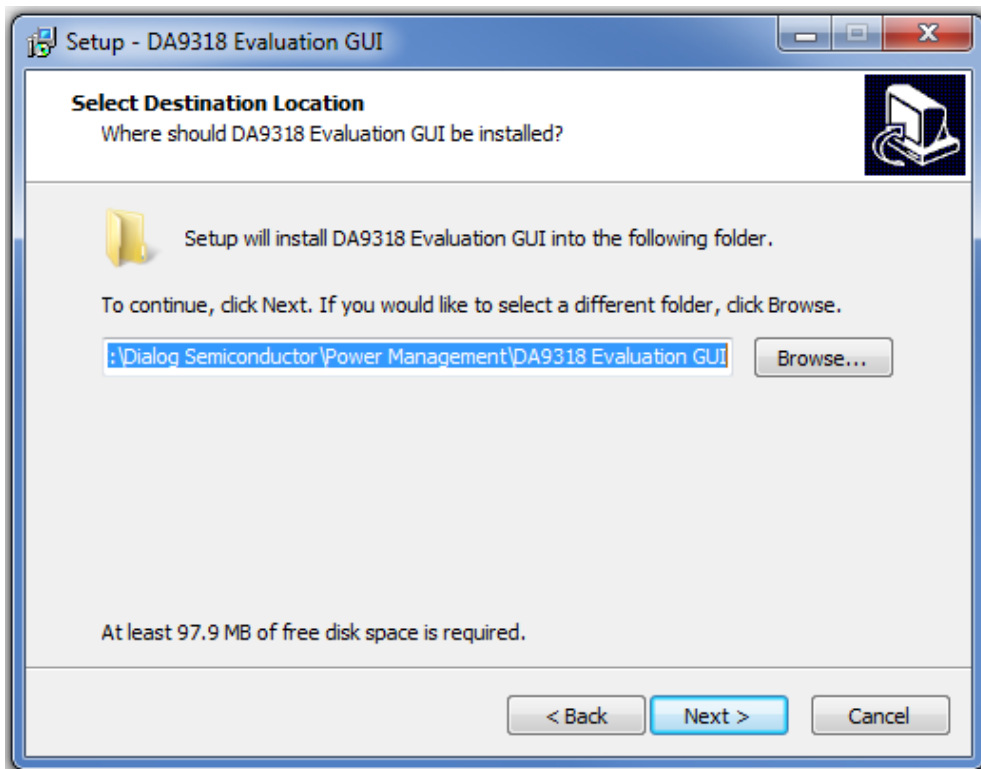

Figure 8: GUI Setup Destination Location

3. Click **Next**.

DA9318 Evaluation Board

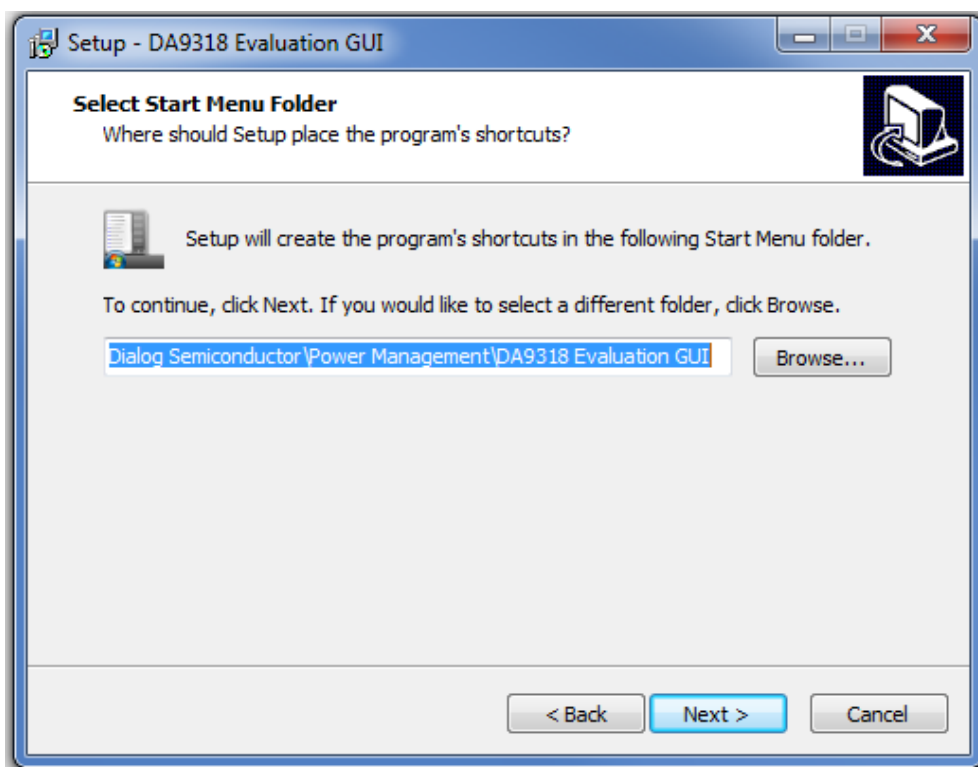

Figure 9: GUI Setup Start Menu Location

- 4. Click **Next**.

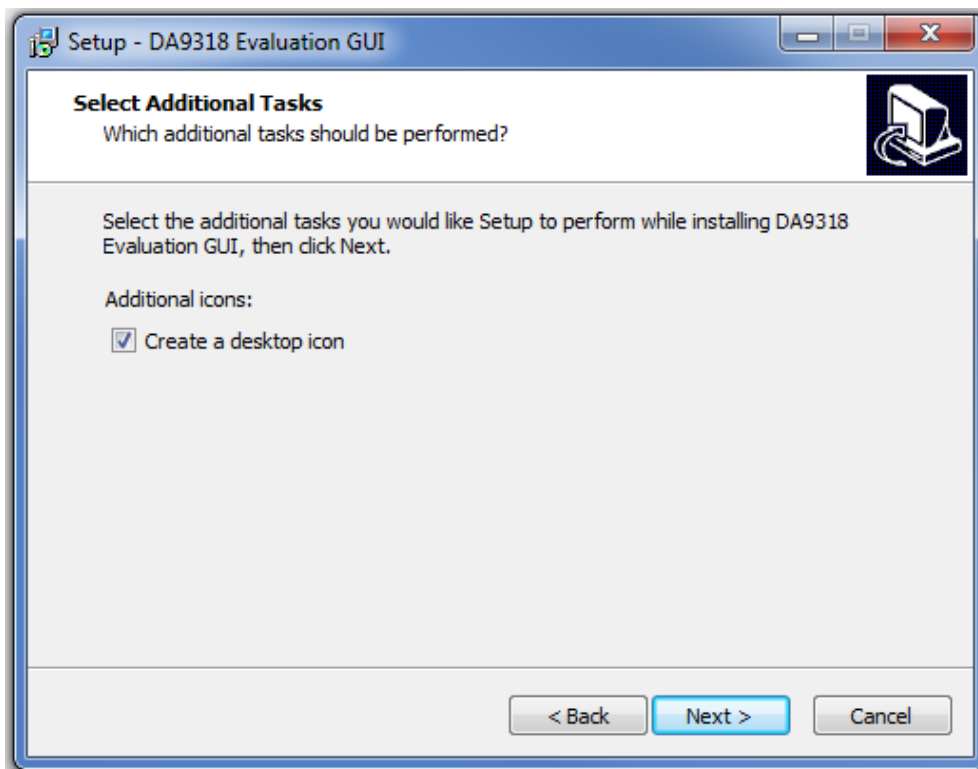

Figure 10: GUI Setup Additional Tasks

- 5. Select the **Create a desktop icon** check box and click **Next**.

DA9318 Evaluation Board

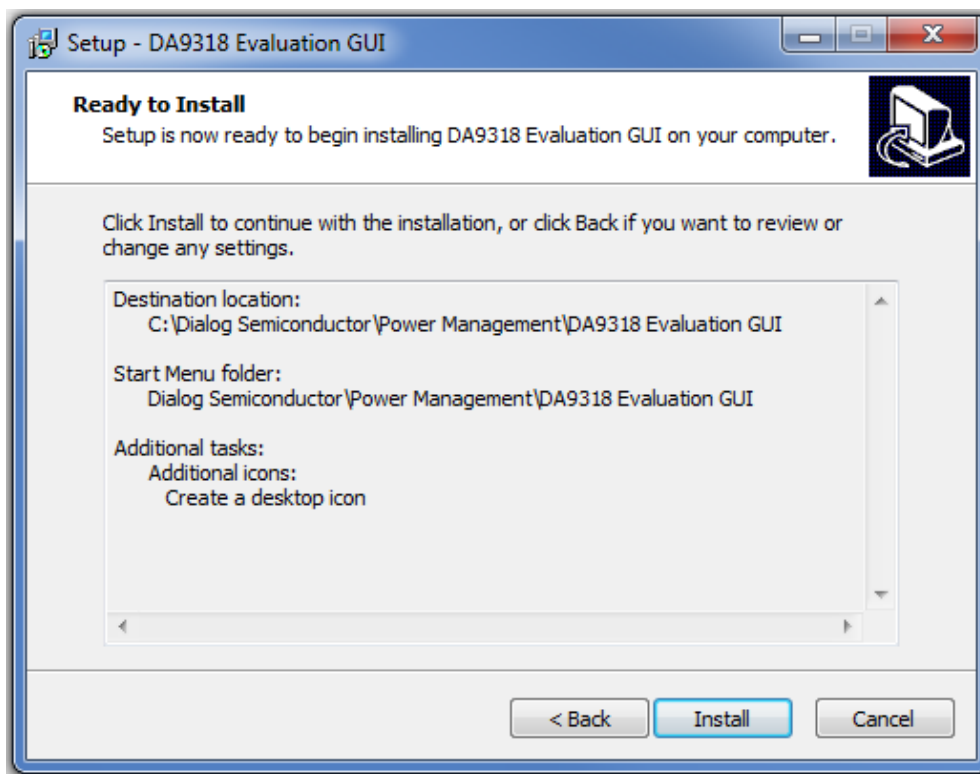

Figure 11: GUI Setup Start Installation

6. Click **Install**.

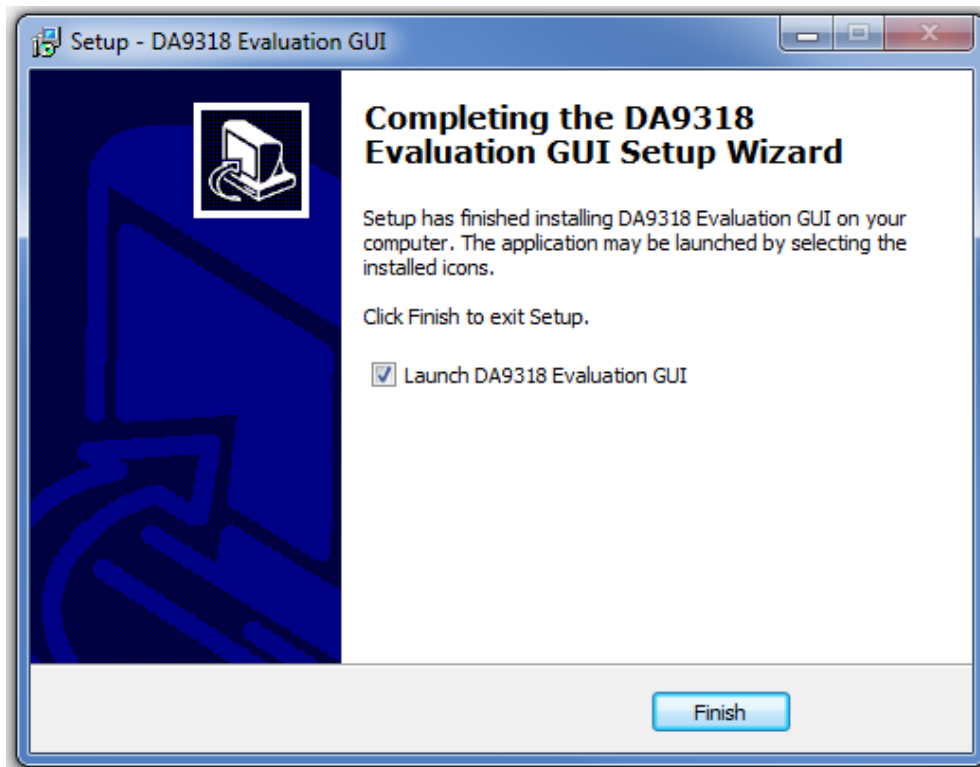

Figure 12: GUI Setup Finish and Launch

7. Click **Finish**.

DA9318 Evaluation Board

Once the installation is completed, you may need to restart your computer.

When the software is installed, insert the USB cable before applying V_{SYS} and V_{IN} . The DA9318 SmartCanvas software can be started after power up.

5.2 Initial USB Connection

On connecting the USB to the PC for the first time, the SAM3U USB driver will request driver updating/installation from the Windows operating system. On Windows 7 (32-bit) operating systems (OS) the driver usually installs automatically. On Windows 7 (64-bit) machines it is common for the complete driver installation to fail. If this happens, install the driver manually by following these steps:

1. **Control Panel** → **Devices and Printers** (double-click device with yellow exclamation sign).
2. **Update Driver**.
3. **Browse my computer for driver software**.
4. Select the **Driver** folder location: **C:\Dialog Semiconductor\Power Management\DA9318 Evaluation Board GUI\Driver**.
5. If Windows warns about the driver, select **Install anyway**.
6. Remove the USB cable and then re-insert it into the evaluation board.

6 GUI Software

Run the DA9318 evaluation board GUI software by clicking the shortcut on the appropriate item in the Windows Start menu (**All Programs** → **Dialog Semiconductor** → **Power Management** → **DA9318Evaluation Board GUI**). The main GUI interface is displayed, see [Figure 13](#).

The minimum recommended setting for the PC display size is 1024x768 pixels. Font size on the PC display should be Normal (95 dpi).

NOTE

A display size other than the recommended setting will affect the way in which the panels appear.

6.1 Controls

Groups of registers are grouped together on tabs to assist with identification of device function or registers of the same type. The GUI has five different tabs for accessing registers within DA9318:

- **Events/Mask/Status:** contains registers related to fault protection indicators
- **Charger:** contains selected registers that control the voltage and current protection limits, as well as the current doubler enable button
- **ADC:** contains the ADC control register and the data reported by the ADC (V_{IN} , I_{IN} , V_{OUT} , V_{BAT} , I_{OUT} , T_{JUNC})
- **Config:** contains miscellaneous configuration registers
- **APPS:** contains the enable bits for IDLE_LP mode and the safety/watchdog timers

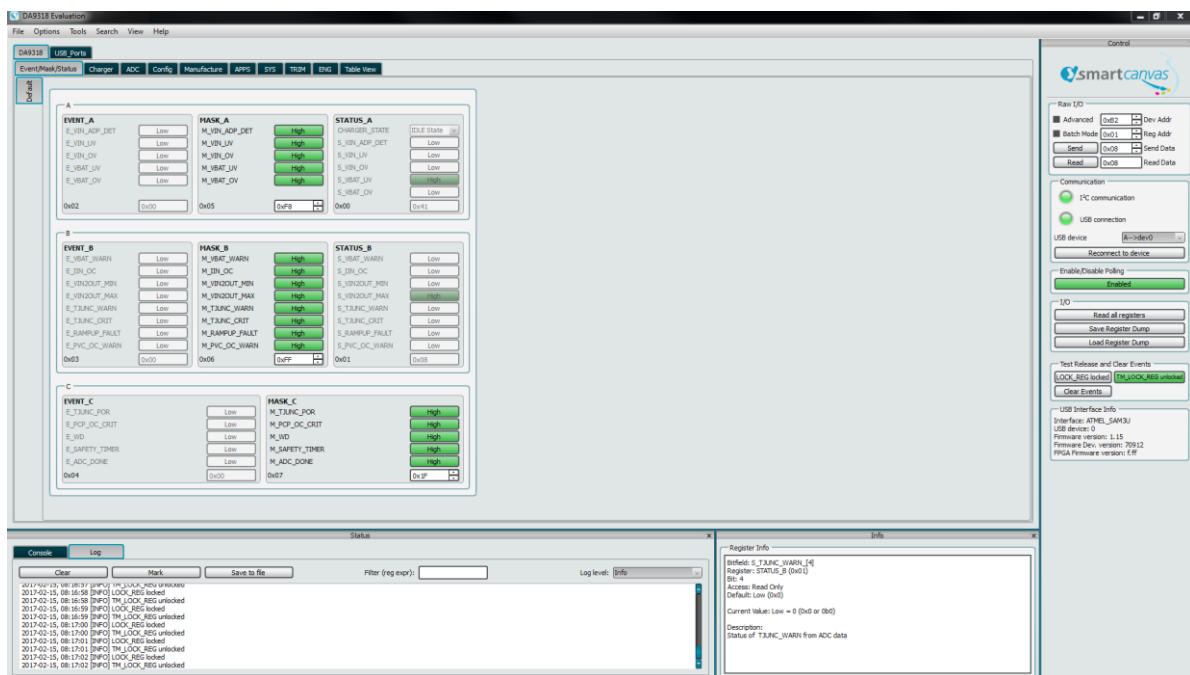

Figure 13: Main GUI Interface

DA9318 Evaluation Board

6.2 Control Windows

All dockable control windows, either on the right or bottom of the main window add additional functionality or monitoring to the GUI. The windows can be undocked, by clicking on and dragging the title bar of that window, and can be placed anywhere on the screen. If desired the **Search** and **Info** windows can be docked on the left hand side of the main window for greater convenience.

6.2.1 Enable/Disable Polling

The polling switch enables or disables polling of the device registers and the refreshing of the registers controls on the GUI interface.

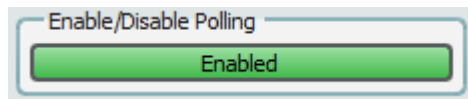

Figure 14: Polling

6.2.2 Raw I/O

The **Raw I/O** control sends the entered device address, register address, and data on the I²C communications interface. If the information sent is not valid then the I²C message will return NACK and an error message will be displayed in the **Status** window.

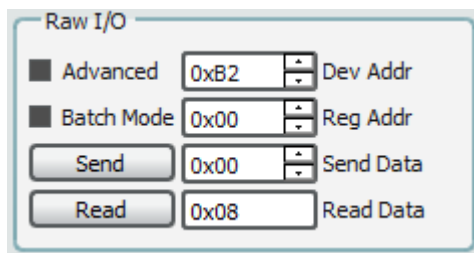

Figure 15: Raw I/O

6.2.3 Interface Control Information

In the **View** menu, click on **Status**, the **Status** window is displayed.

In the **Status** window, select the **Log** tab and **Log Level: Info**. This will display interface control information including: name, parent register and the bits to which this control corresponds, current value, whether it is read-only or R/W access, and finally a description of each possible setting.

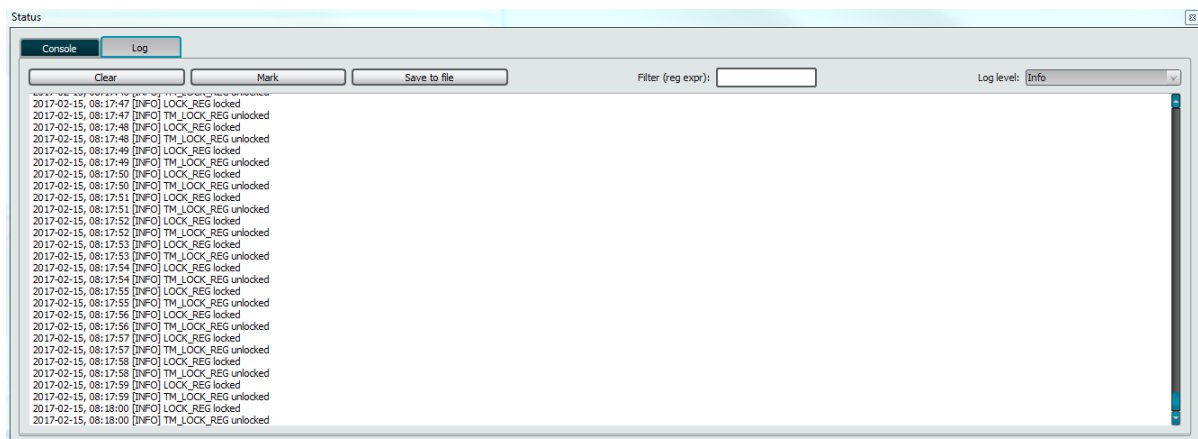

Figure 16: Interface Control Information

DA9318 Evaluation Board

6.3 ADC Plotter

The DA9318 features an ADC plotting window which can plot ADC data over time. The ADC plotting tool can plot raw ADC data as well as the equivalent voltage/current/temperature. Access the ADC plotting tool from the **Tools** menu.

6.4 Quick Start Guide

To get the current doubler operational and switching:

1. Connect a power supply between IN and GND.
2. Connect a source meter, battery emulator, or battery between OUT and GND.
3. Connect the SYS connector to the OUT connector.
4. Set V_{IN} to 7.5 V.
5. Set V_{OUT} and V_{SYS} to 3.6 V (when using a real battery, set V_{IN} to $2 \cdot V_{BAT} + 300$ mV).
6. Check the **EVENT** and **STATUS** registers in the **EVENT/STATUS/MASK** tab of the GUI. If any event has been flagged it is cleared by pressing the **Clear Events** button on the right side of the GUI.
7. When starting the current doubler, all the **EVENT** and **STATUS** register bits should be set to 0, except **S_VIN_ADP_DET** which should be 1.
8. On the **Charger** tab, set **CP_EN** to high. After doing this, the **CP_SWITCHING** bit should transition from 0 to 1 to indicate that the current doubler is operational. If **CP_SWITCHING** is still low after setting **CP_EN** to 1, continue with the following steps:
 - a. Verify the **STATUS** and **EVENT** registers, there should be no event flag generated. The **STATUS_A** charger state should have switched from **IDLE** to **ACTIVE** after clicking the **CP_EN** button.
 - b. Increase the VIN2VOUT minimum threshold before setting **CP_EN** to high:
WRITE DA9315 0x1C 0x4A
WRITE DA9315 0x21 0xD0
 - c. If a current meter is connected between the IN power supply and the IN plug on the evaluation board, temporarily short the current meter until the current doubler is switching, then remove the short.
9. A real battery or high bandwidth battery emulator is recommended for testing. If using a source meter on the output, the source meter should be configured for high bandwidth operation. In addition, the current measurement range of the source meter should be changed from **auto** to a fixed value that is appropriate for the test.

DA9318 Evaluation Board

Revision History

Revision	Date	Description
1.3	16-Feb-2022	Document rebranded to Renesas.
1.2	27-Mar-2019	Latest revision. Default link position updated
1.1	24-Jul-2017	Additional recommended setup conditions for using a source meter in place of a real battery.
<ul style="list-style-type: none">■ Section 6.4: Quick Start Guide<ul style="list-style-type: none">○ Added step 11.		
1.0	15-Feb-2017	Initial version.

DA9318 Evaluation Board

Status Definitions

Status	Definition
DRAFT	The content of this document is under review and subject to formal approval, which may result in modifications or additions.
APPROVED or unmarked	The content of this document has been approved for publication.

DA9318 Evaluation Board

Important Notice and Disclaimer

RENESAS ELECTRONICS CORPORATION AND ITS SUBSIDIARIES ("RENESAS") PROVIDES TECHNICAL SPECIFICATIONS AND RELIABILITY DATA (INCLUDING DATASHEETS), DESIGN RESOURCES (INCLUDING REFERENCE DESIGNS), APPLICATION OR OTHER DESIGN ADVICE, WEB TOOLS, SAFETY INFORMATION, AND OTHER RESOURCES "AS IS" AND WITH ALL FAULTS, AND DISCLAIMS ALL WARRANTIES, EXPRESS OR IMPLIED, INCLUDING, WITHOUT LIMITATION, ANY IMPLIED WARRANTIES OF MERCHANTABILITY, FITNESS FOR A PARTICULAR PURPOSE, OR NON-INFRINGEMENT OF THIRD PARTY INTELLECTUAL PROPERTY RIGHTS.

These resources are intended for developers skilled in the art designing with Renesas products. You are solely responsible for (1) selecting the appropriate products for your application, (2) designing, validating, and testing your application, and (3) ensuring your application meets applicable standards, and any other safety, security, or other requirements. These resources are subject to change without notice. Renesas grants you permission to use these resources only for development of an application that uses Renesas products. Other reproduction or use of these resources is strictly prohibited. No license is granted to any other Renesas intellectual property or to any third party intellectual property. Renesas disclaims responsibility for, and you will fully indemnify Renesas and its representatives against, any claims, damages, costs, losses, or liabilities arising out of your use of these resources. Renesas' products are provided only subject to Renesas' Terms and Conditions of Sale or other applicable terms agreed to in writing. No use of any Renesas resources expands or otherwise alters any applicable warranties or warranty disclaimers for these products.

© 2022 Renesas Electronics Corporation. All rights reserved.

(Rev.1.0 Mar 2020)

Corporate Headquarters

TOYOSU FORESIA, 3-2-24 Toyosu

Koto-ku, Tokyo 135-0061, Japan

www.renesas.com

Contact Information

For further information on a product, technology, the most up-to-date version of a document, or your nearest sales office, please visit:

<https://www.renesas.com/contact/>

Trademarks

Renesas and the Renesas logo are trademarks of Renesas Electronics Corporation. All trademarks and registered trademarks are the property of their respective owners.

IMPORTANT NOTICE AND DISCLAIMER

RENESAS ELECTRONICS CORPORATION AND ITS SUBSIDIARIES (“RENESAS”) PROVIDES TECHNICAL SPECIFICATIONS AND RELIABILITY DATA (INCLUDING DATASHEETS), DESIGN RESOURCES (INCLUDING REFERENCE DESIGNS), APPLICATION OR OTHER DESIGN ADVICE, WEB TOOLS, SAFETY INFORMATION, AND OTHER RESOURCES “AS IS” AND WITH ALL FAULTS, AND DISCLAIMS ALL WARRANTIES, EXPRESS OR IMPLIED, INCLUDING, WITHOUT LIMITATION, ANY IMPLIED WARRANTIES OF MERCHANTABILITY, FITNESS FOR A PARTICULAR PURPOSE, OR NON-INFRINGEMENT OF THIRD-PARTY INTELLECTUAL PROPERTY RIGHTS.

These resources are intended for developers who are designing with Renesas products. You are solely responsible for (1) selecting the appropriate products for your application, (2) designing, validating, and testing your application, and (3) ensuring your application meets applicable standards, and any other safety, security, or other requirements. These resources are subject to change without notice. Renesas grants you permission to use these resources only to develop an application that uses Renesas products. Other reproduction or use of these resources is strictly prohibited. No license is granted to any other Renesas intellectual property or to any third-party intellectual property. Renesas disclaims responsibility for, and you will fully indemnify Renesas and its representatives against, any claims, damages, costs, losses, or liabilities arising from your use of these resources. Renesas' products are provided only subject to Renesas' Terms and Conditions of Sale or other applicable terms agreed to in writing. No use of any Renesas resources expands or otherwise alters any applicable warranties or warranty disclaimers for these products.

(Disclaimer Rev.1.01 Jan 2024)

Corporate Headquarters

TOYOSU FORESIA, 3-2-24 Toyosu,
Koto-ku, Tokyo 135-0061, Japan
www.renesas.com

Trademarks

Renesas and the Renesas logo are trademarks of Renesas Electronics Corporation. All trademarks and registered trademarks are the property of their respective owners.

Contact Information

For further information on a product, technology, the most up-to-date version of a document, or your nearest sales office, please visit www.renesas.com/contact-us/.