

ISL6269AEVAL2Z

User Guide For ISL6269A and ISL6269B PWM Controllers

AN1273
Rev 2.00
Nov 14, 2007

Introduction

The ISL6269AEVAL2Z evaluation board demonstrates the performance of the ISL6269A or ISL6269B single-phase synchronous-buck PWM controller featuring Intersil's Robust Ripple Regulator (R³) technology. The ISL6269AEVAL2Z is shipped with the ISL6269A controller installed. The ISL6269B controller can be evaluated using the ISL6269AEVAL2Z with no further circuit modifications beyond changing the IC. An on-board dynamic-load generator is included for evaluating the transient-load response, that applies a 2.5ms pulse of 250mΩ across V_{OUT} and GND every 30ms. Contents of this document include:

- Design Criteria
- Recommended Test Equipment
- Interface Connections
- Switch Descriptions
- Jumper Descriptions
- Test Point Descriptions
- Typical Waveforms
 - Start-up
 - Shut-down
 - Diode-emulation
 - Load-transient response
 - Line-transient response
- Evaluation Board Documentation
 - Schematic
 - Bill of materials
 - Silk-screen plots
 - Board layer plots

TABLE 1. DC/DC DESIGN CRITERIA

PARAMETER	VALUE	UNITS
VIN	5 to 25	VDC
VOUT	1.10 or 1.20	VDC
FULL-LOAD	5.0	ADC
PWM FREQUENCY	300 or 600	kHz

Design Criteria

The design criteria listed in Table 1 was, to a large extent, influenced by customer input. The PWM switching frequency can be programmed to any frequency between 200kHz and 600kHz. If only one PWM frequency setting is desired, this can be accomplished by simply not populating R₁₇. The output voltage can be programmed to any voltage between 0.6V and 3.3V. If only one output voltage setting is desired, this can be accomplished by simply not populating R₁₆.

The OCP setpoint resistor R_{SEN} (R₁₃) is selected to protect the output load, without nuisance shutdowns due to component tolerances and temperature effects. Using Equation 1 finds R_{SEN} (R₁₃) = 6.49kΩ where:

$$R_{SEN} = \frac{(I_{FL} + \frac{I_{PP}}{2}) \cdot OC_{SP} \cdot r_{DS(ON)}}{I_{OC}} \quad (EQ. 1)$$

- r_{DS(ON)} of Q4 low-side MOSFETs is 15mΩ
- I_{OC} is 26μA
- I_{FL} is 5A continuous
- I_{PP} is 1.5A_{PP} (30% of I_{FL} 5A)
- OC_{SP} is 2.1 (210% of I_{FL})

The PWM switching frequency f_{SW} is programmed for 300kHz by resistance R_{FSET} (R₁₂) when switch S2 is in the LOWER position. Setting switch S2 in the UPPER position will program f_{SW} for approximately 600kHz with the parallel resistance of R₁₂ and R₁₇. Using Equation 2 finds the value for R_{FSET} (R₁₂) = 57.6kΩ. The “K” constant in Equation 2 is ideally 66.8 x 10⁻¹² however, this value can be affected by the ripple voltage on the COMP pin. The ripple voltage on the COMP pin increases with the bandwidth of the feedback loop compensation, effectively reducing the value of “K”. The ISL6269AEVAL2Z evaluation board is aggressively compensated for approximately 100kHz bandwidth, making the value of “K” effectively 58 x 10⁻¹².

$$R_{FSET} = \frac{1}{K \cdot f_{SW}} \quad (EQ. 2)$$

The output voltage is programmed for 1.10V using resistors R₁₉ (R_{TOP}) and R₂₀ (R_{BOTTOM}) when switch S3 is in the LOWER position. Setting switch S3 in the UPPER position will program the output voltage for 1.20V using resistor R₁₉ (R_{TOP}) and the parallel resistance of R₂₀ and R₁₆ (R_{BOTTOM}). The loop compensation is usually responsible for selecting R_{TOP} (R₁₉), which in this case is 3.01kΩ. The voltage setpoint programming resistance R_{BOTTOM} is calculated using Equation 3 where:

$$R_{BOTTOM} = \frac{(V_{REF} \cdot R_{TOP})}{(V_{OUT} - V_{REF})} \quad (EQ. 3)$$

- V_{REF} = 600mV
- R_{TOP} = 3.01kΩ
- V_{OUT} = 1.10V or 1.20V

Begin by finding the value of R₂₀ for V_{OUT} = 1.10V from Equation 2: R₂₀ = 3.57kΩ. Find the value of parallel resistance R₂₀ and R₁₆ for V_{OUT} = 1.20V from Equation 3: R₂₀ || R₁₆ = 3.01kΩ, therefore R₁₆ = 19.1kΩ.

Recommended Equipment

- (QTY 1) Adjustable 25V, 3A Power Supply
- (QTY 1) Fixed 12V, 100mA Power Supply
- (QTY 1) Fixed 5V, 100mA Power Supply
- (QTY 1) Adjustable 5A Constant Current Electronic Load
- (QTY 1) DVM
- (QTY 1) Four Channel Oscilloscope

Interface Connections

- V_{IN} : Input voltage to the power stage of the converter
 - J5: V_{IN} positive power input
 - J7: V_{IN} return power input
- V_{OUT} : Regulated output voltage from the converter
 - J6: V_{OUT} positive power output
 - J8: V_{OUT} return power output
- +5VIN: +5V input voltage for PVCC, PGOOD-LED, and pull-up voltage rail
 - J2: 5V positive input
 - J1: 5V return input
- +12V: Input voltage for the dynamic-load generator
 - J4: 12V positive input
 - J3: 12V return input

Switch Descriptions

- S1: ENABLE
 - OFF: Shorts the EN pin to GND (disable PWM)
 - ON: Allows the EN pin to pull-up to +5V (enable PWM)
- S2: DYNAMIC FPWM
 - LOWER: Selects the lower of two programmed f_{SW}
 - UPPER: Selects the higher of two programmed f_{SW}
- S3: DYNAMIC VOUT
 - LOWER: Selects the lower of two programmed output voltages
 - UPPER: Selects the higher of two programmed output voltages
- S4: FCCM
 - DEM: Enables diode-emulation-mode
 - CCM: Inhibits diode-emulation-mode
- S5: DYNAMIC LOAD
 - OFF: Load disabled
 - ON: Load enabled

Jumper Descriptions

- JP1: Selects the +5V source for VCC, PVCC and auxiliary circuits. See Table 1 for list of configurations.
- JP2: Connects +5V supply to the PGOOD LED circuit and pull-up resistors. The shunt jumper is normally installed. Remove the shunt jumper when making low power efficiency measurements.
- JP3: Isolates the EN input pin from switch S1 so that an external signal can be used.
- JP4: Isolates the frequency range selection switch S2 so that an external signal can be used.
- JP5: Isolates the V_{OUT} selection switch S3 so that an external signal can be used.
- JP6: Isolates the FCCM input pin from switch S4 so that an external signal can be used.
- JP7: Isolates the PGOOD input pin from the LED circuit so that the pull-down resistance can be measured.
- JP8: Opens the circuit path to the VIN pin so that an ammeter can be inserted for measuring current into the VIN pin.

TABLE 2. JUMPER JP1 CONFIGURATIONS

JP1			SOURCE OF 5V		
PIN 1 to 2	PIN 3 to 4	PIN 5 to 6	VCC	PVCC	AUX
SHORT	SHORT	SHORT	J2	J2	J2
SHORT	OPEN	SHORT	TP8	TP8	J2
SHORT	SHORT	OPEN	J2	TP7	J2

Test-point Descriptions

- TP1 to TP5: Signal ground
- TP6: Scope-probe socket for measuring V_{IN}
- TP7: Monitors the voltage at the PVCC pin
- TP8: Monitors the voltage of JP1 pins 2, 4 and 6
- TP9: Monitors the voltage at JP4 pin 1
- TP10: Monitors the voltage at JP5 pin 1
- TP11: Monitors the voltage at the PGOOD pin
- TP12: Monitors the voltage at the FSET pin
- TP13: Monitors the voltage at the upper feedback resistor
- TP14: Monitors the voltage at the FB pin (SENSITIVE)
- TP15: Monitors the voltage at the COMP pin (SENSITIVE)
- TP16: Monitors the voltage at the EN pin
- TP17: Monitors the voltage at the FCCM pin
- TP18: Monitors the voltage at the VCC pin
- TP19: Scope-probe socket for measuring V_{OUT}
- TP20: V_{IN} positive voltage sense
- TP21: V_{IN} return voltage sense
- TP22: Monitors the voltage at the VIN pin
- TP23: V_{OUT} positive voltage sense
- TP24: V_{OUT} return voltage sense
- TP25: Scope-probe socket for measuring the voltage of the PHASE node
- TP26: Scope-probe socket for measuring voltage across the dynamic-load resistors (hence load current)
- TP27: Monitors the voltage at the gate terminal of the dynamic load MOSFET

Typical Waveforms

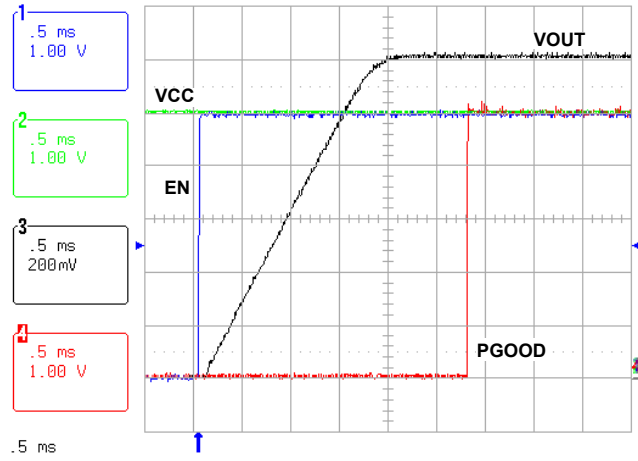

FIGURE 1. SOFT-START: 250mΩ LOAD, FCCM = HIGH

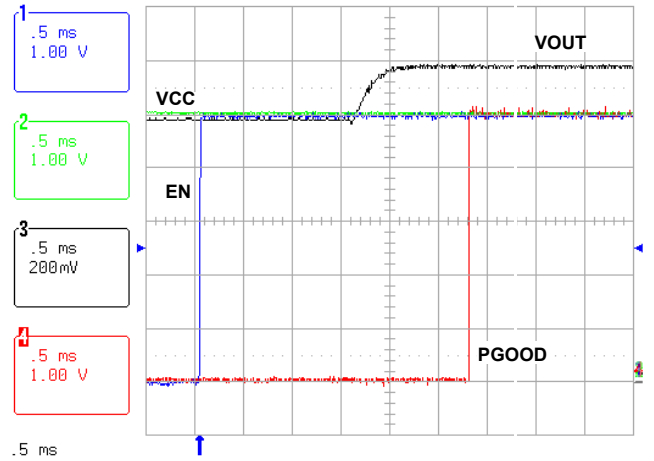

FIGURE 2. SOFT-START: NO-LOAD, FCCM = HIGH, 1V VOUT-PREBIAS

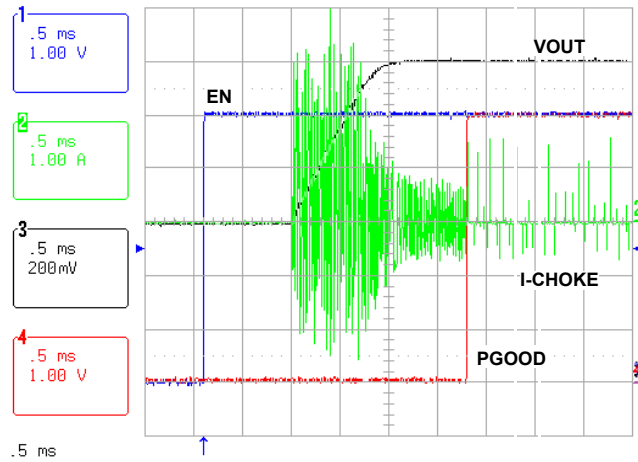

FIGURE 3. OUTPUT CAPACITOR IN-RUSH CURRENT: 50Ω LOAD, FCCM = LOW, 1V VOUT-PREBIAS

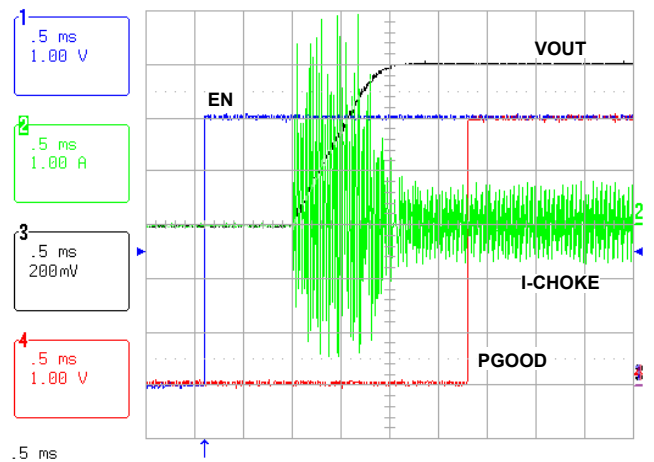

FIGURE 4. OUTPUT CAPACITOR IN-RUSH CURRENT: 50Ω LOAD, FCCM = HIGH, 1V VOUT-PREBIAS

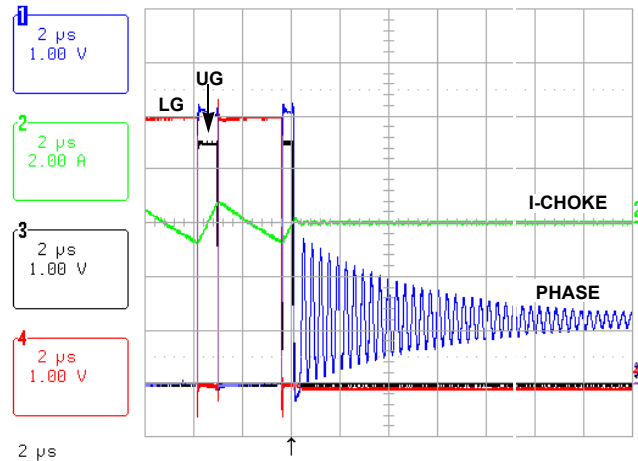

FIGURE 5. SHUTDOWN: EN PULLED LOW, NO-LOAD

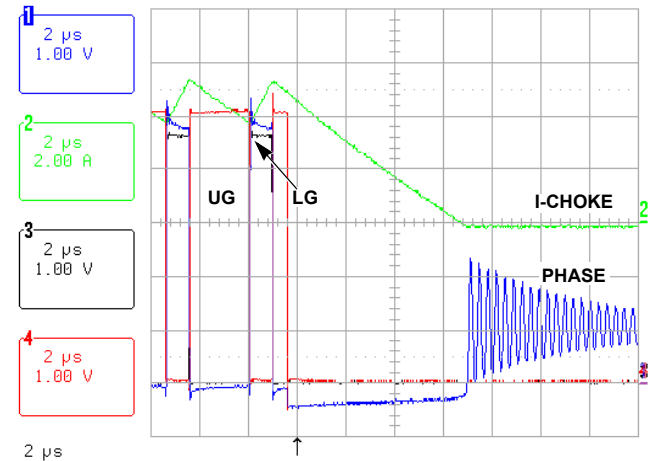

FIGURE 6. SHUTDOWN: EN FALLING, 250mΩ-LOAD

Typical Waveforms (Continued)

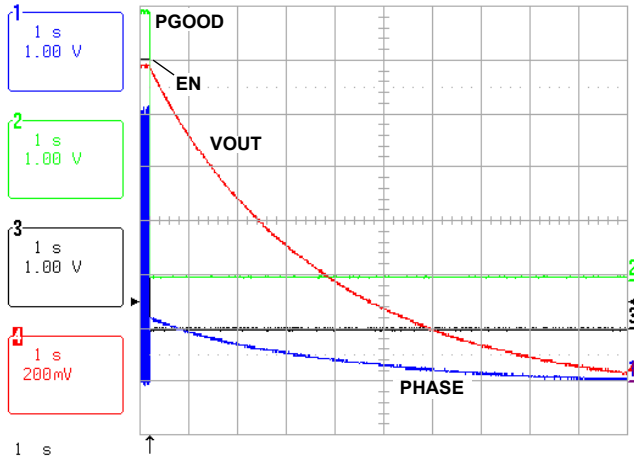

FIGURE 7. SHUTDOWN: VOUT DECAY, NO-LOAD

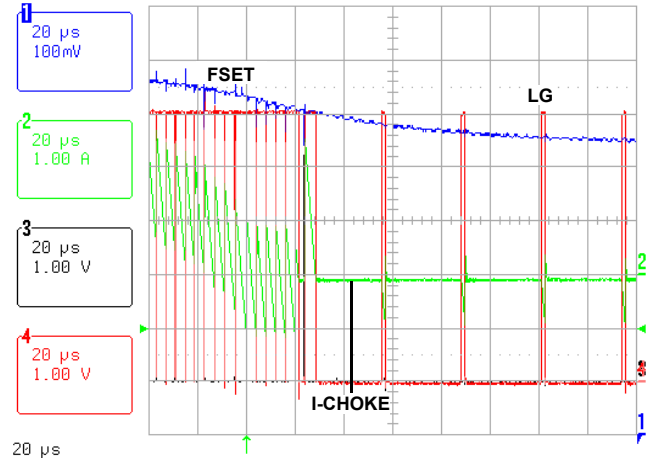

FIGURE 8. ENTERING DEM: 250mΩ LOAD-DUMP (UG TOO NARROW TO SEE)

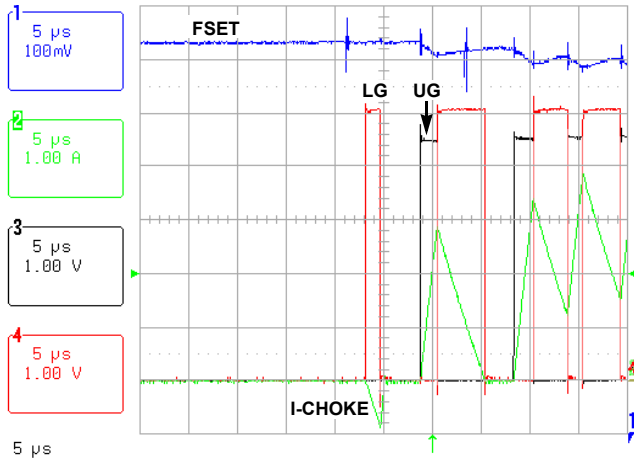

FIGURE 9. EXITING DEM: 250mΩ LOAD-STEP

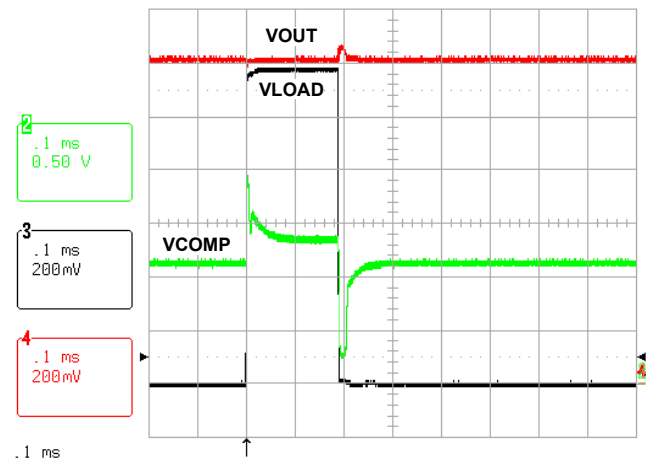

FIGURE 10. LOAD TRANSIENT: FCCM = HIGH, IN CCM BEFORE 250mΩ LOAD-STEP

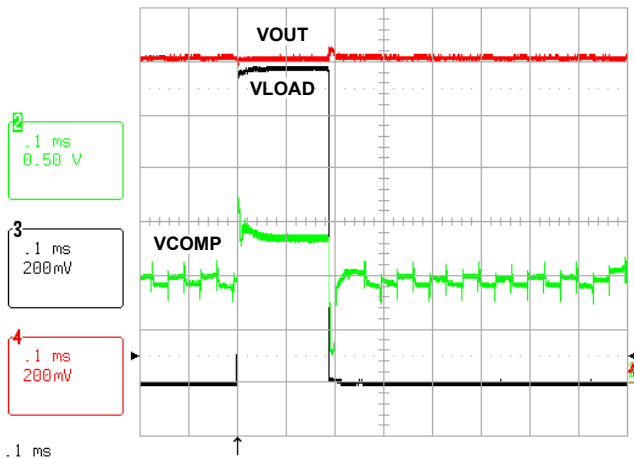

FIGURE 11. LOAD TRANSIENT: FCCM = LOW, IN DEM BEFORE 250mΩ LOAD-STEP

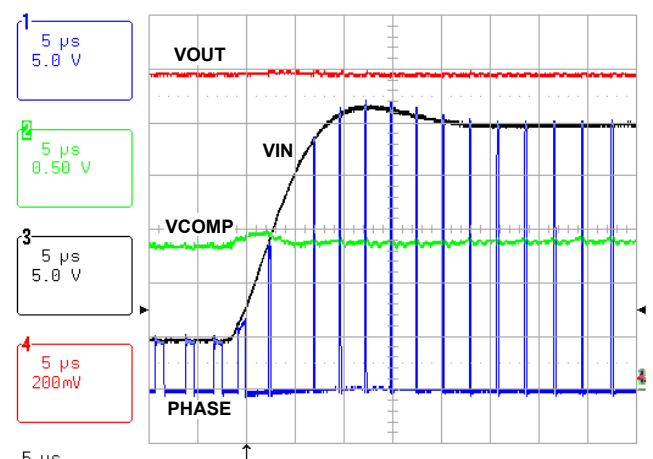

FIGURE 12. LINE TRANSIENT: 5V TO 25V STEP, 250mΩ LOAD

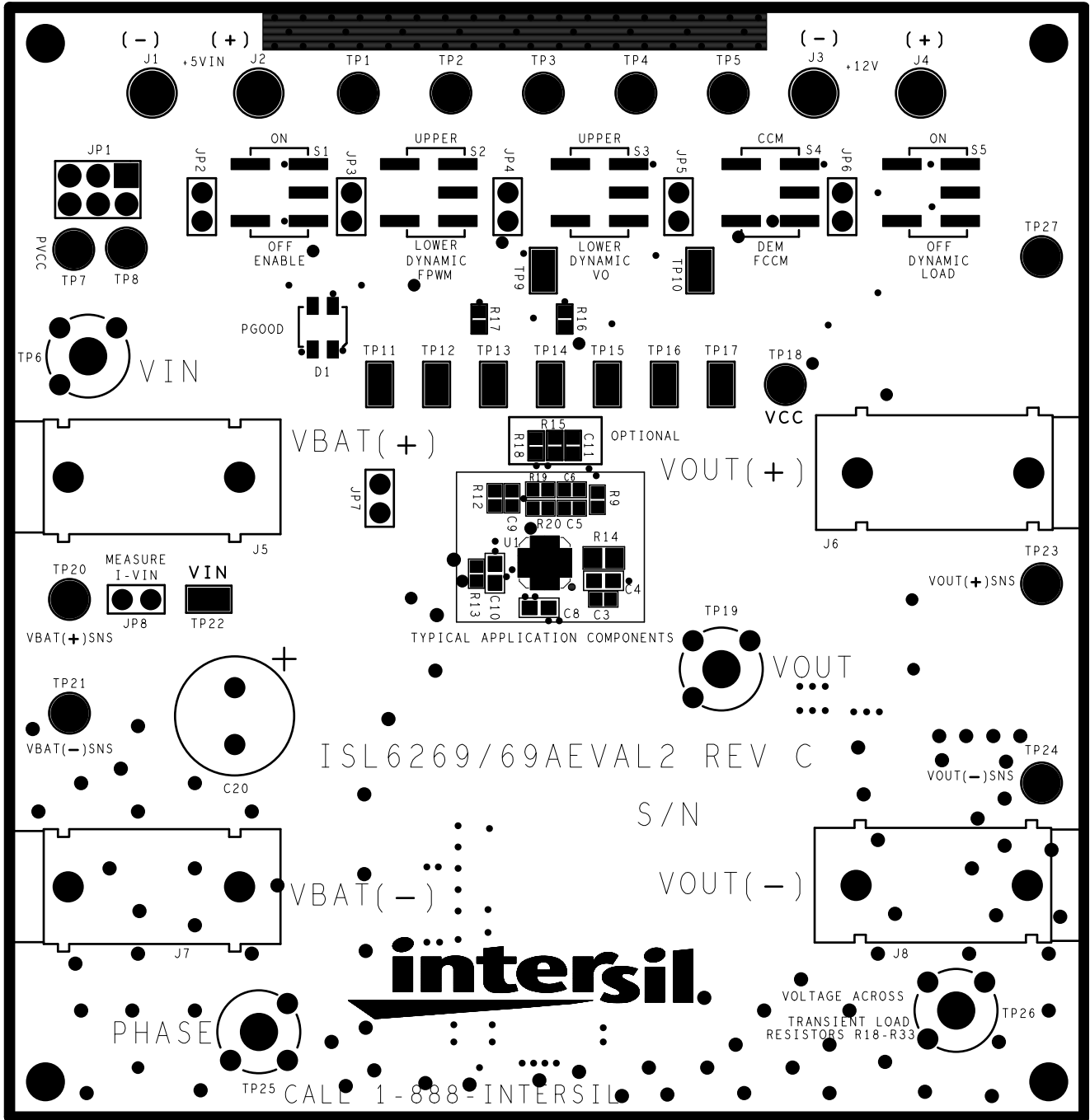

FIGURE 14. PCB TOP SILK SCREEN

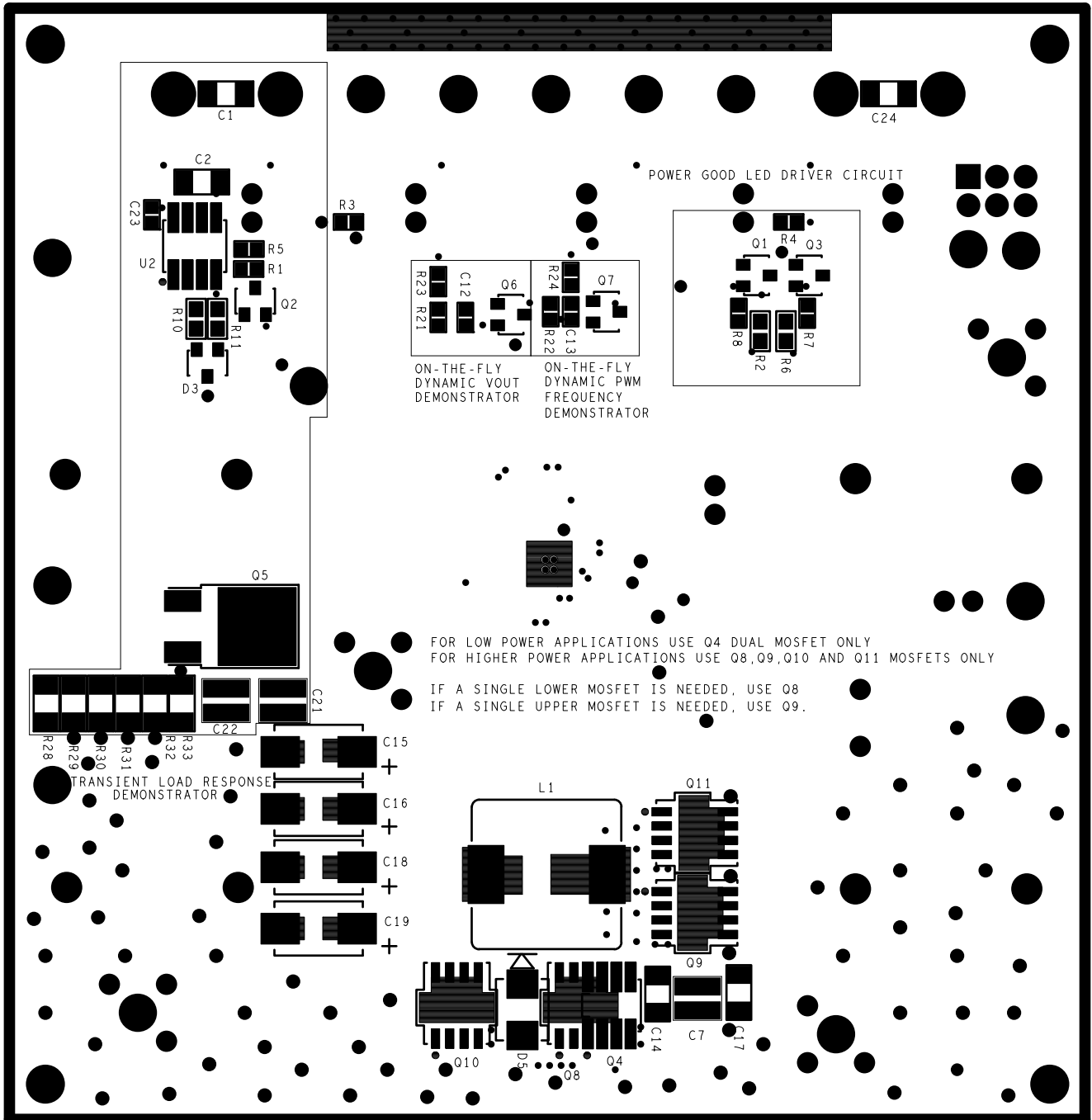

FIGURE 15. PCB BOTTOM SILK SCREEN (MIRRORED)

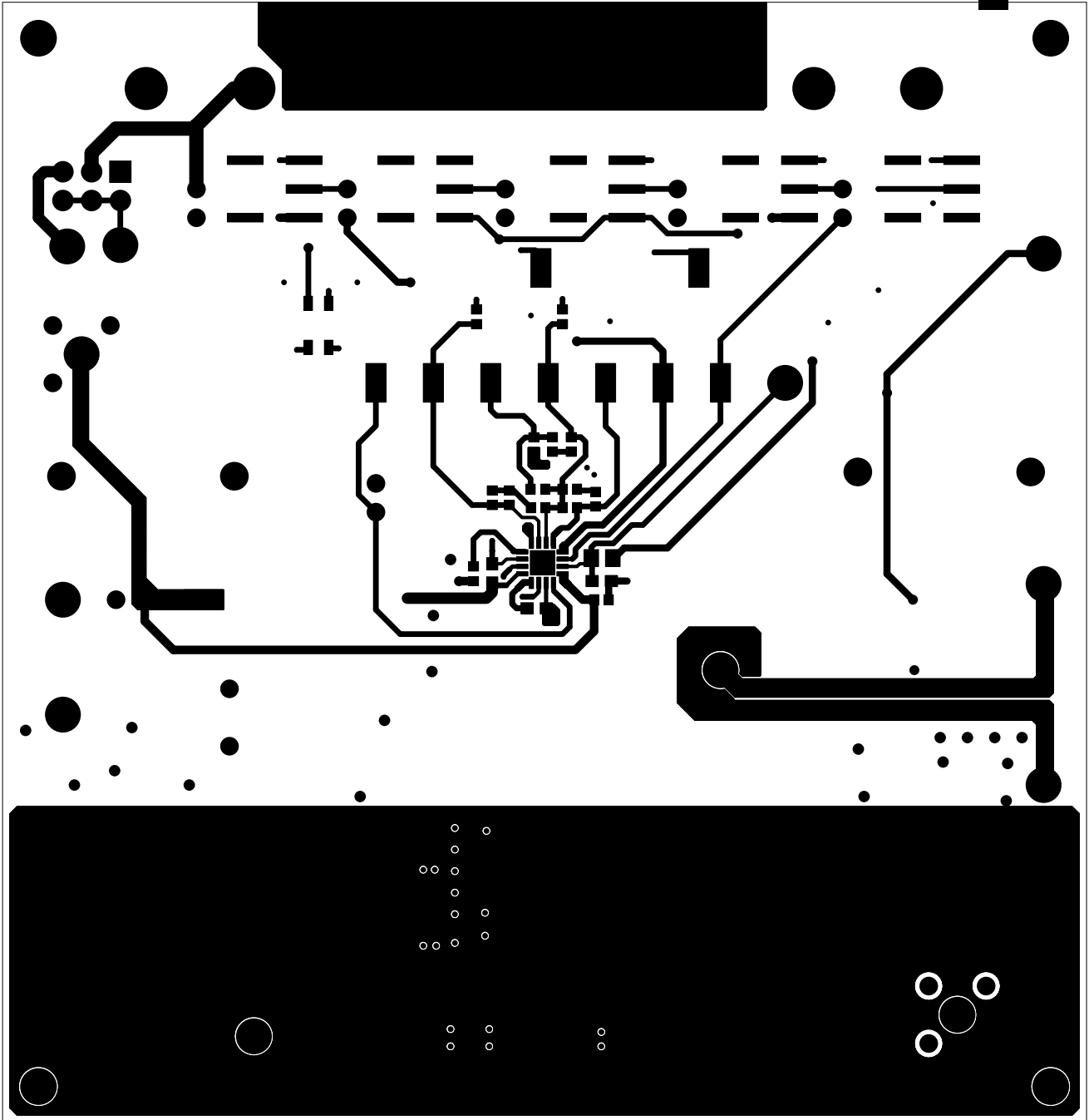

FIGURE 16. PCB TOP LAYER ETCH

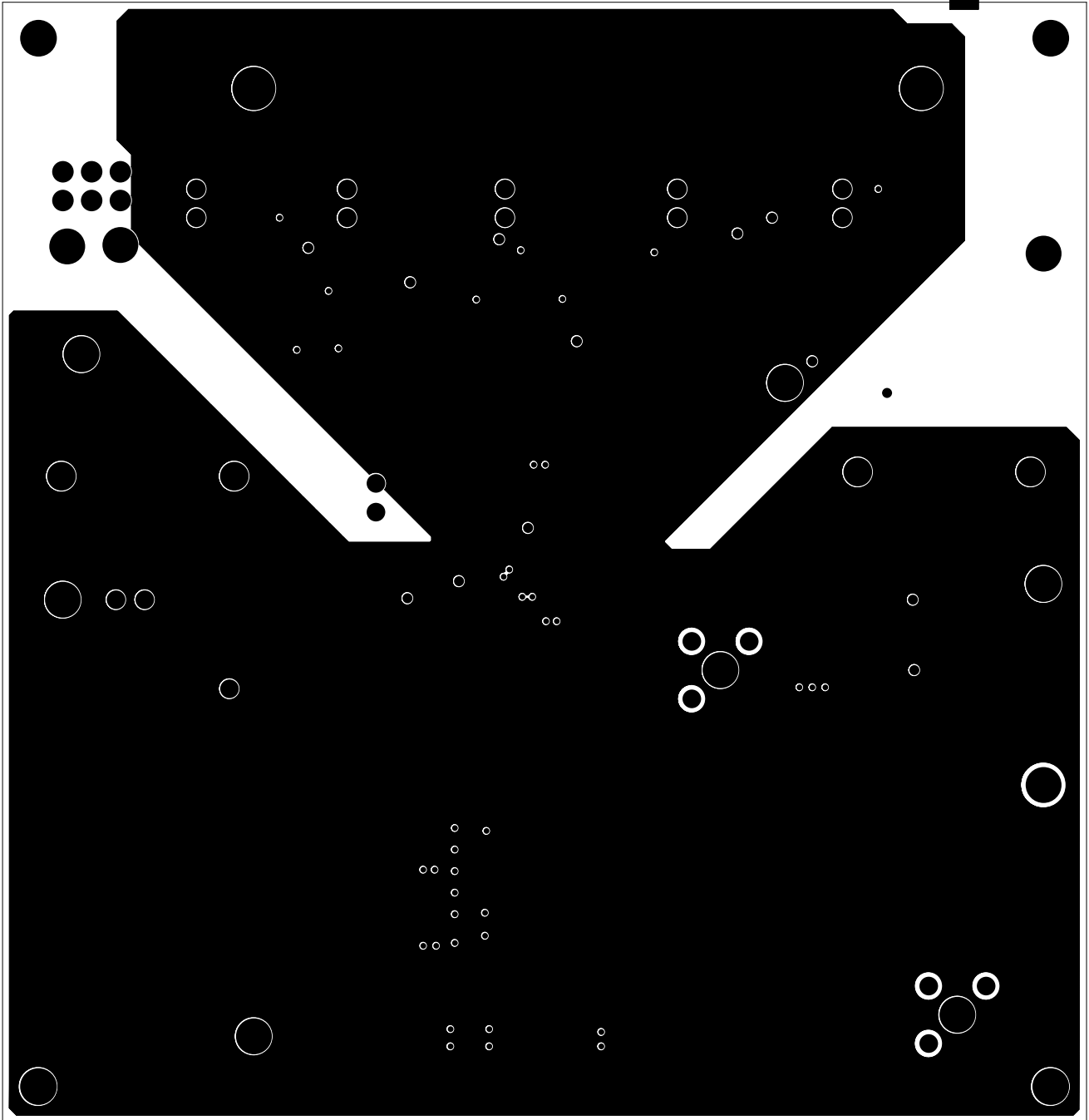

FIGURE 17. PCB LAYER 2 ETCH

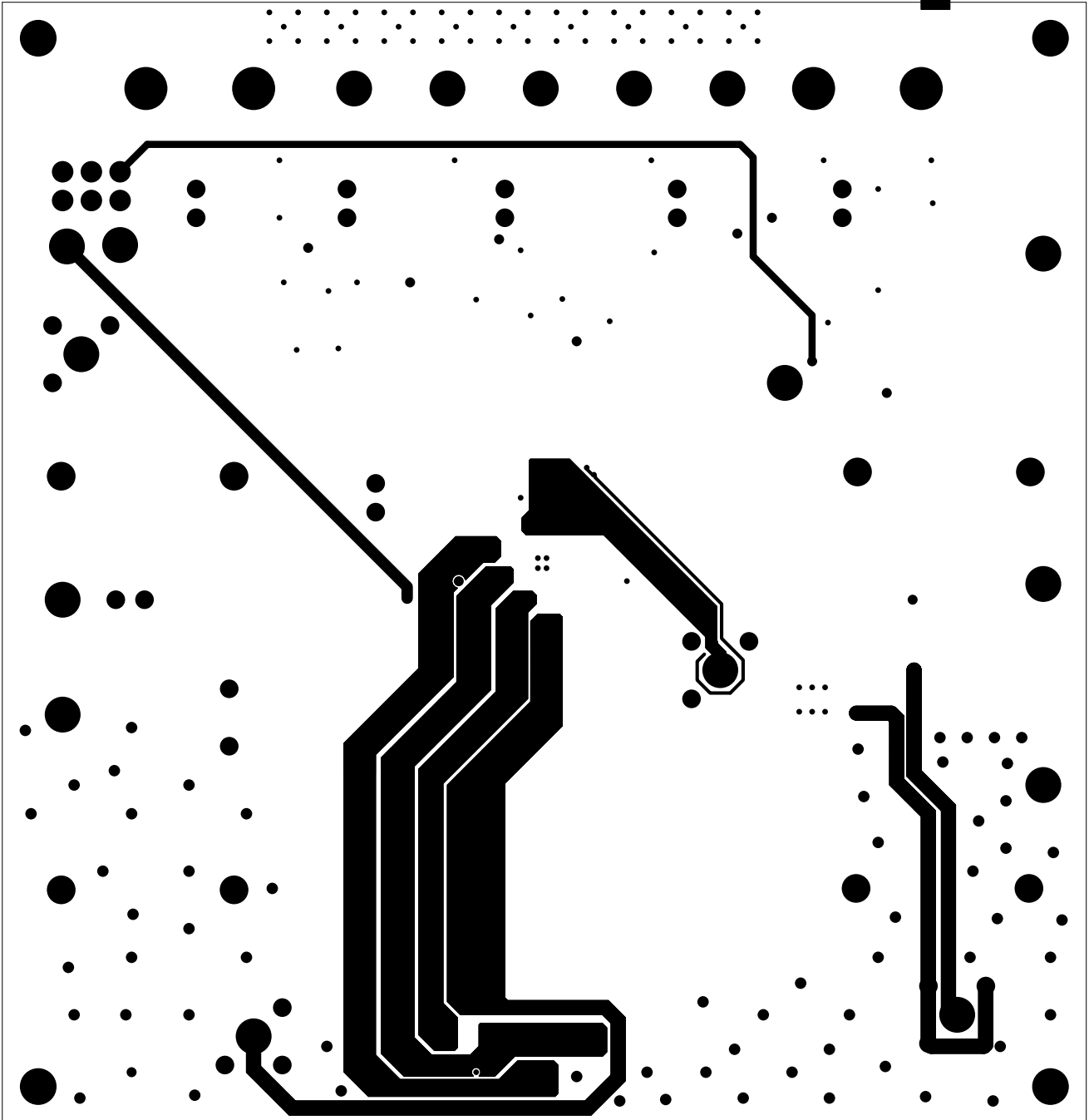

FIGURE 18. PCB LAYER 3 ETCH

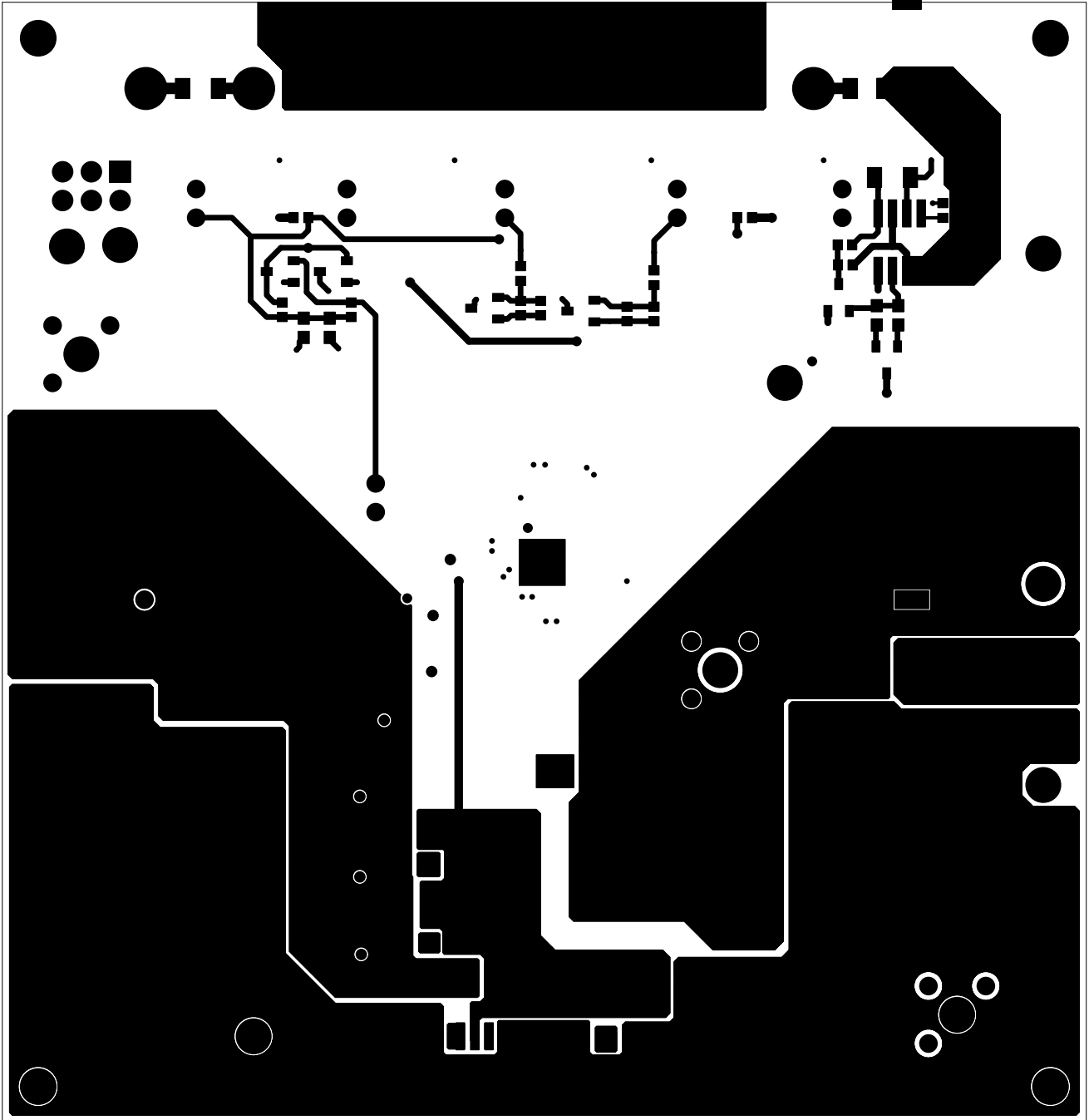

FIGURE 19. PCB BOTTOM LAYER ETCH

Bill of Materials

QTY	REFERENCE	DESCRIPTION/COMMENT	MFG NAME	MFG NUMBER
5	C1, C2, C14, C17, C24	CAP, SMD, 1206, 10 μ F, 25V, 20%, X5R, ROHS	PANASONIC	ECJ-3YB1E106M
2	C12, C13	CAP, SMD, 0402, 0.1 μ F, 16V, 10%, X7R, ROHS	MURATA	GRM36X7R104K016AD
4	C15, C16, C18, C19	CAP, SMD, 7.3mmx4.3mm, 150 μ F, 4V, 20%, SP-CAP	PANASONIC	EEF-SD0G151R
1	C20	CAP, RADIAL, 56 μ F, 25V, OSCON	SANYO	25SP56M
2	C21, C22	CAPACITOR, SMD, 0612, 4.7 μ F, 6.3V, 10%, X5R	TDK	C1632X5R0J475K
1	C3	CAP, SMD, 0402, 0.01 μ F, 25V, 10%, X7R, ROHS	AVX	04023C103KAT
2	C4, C10	CAP, SMD, 0603, 4.7 μ F, 6.3V, 20%, X5R, ROHS	TDK	C1608X5R0J475M
1	C5	CAP, SMD, 0402, 4.7pF, 50V, 0.25pF, NPO, ROHS	MURATA	GRM36COG4R7C050AQ
1	C6	CAP, SMD, 0402, 470pF, 50V, 10%, X7R, ROHS	PANASONIC	ECJ-0EB1H471K
1	C7	CAPACITOR, SMD, 0612, 0.47 μ F, 25V, 10%, X7R	TDK	C1632X7R1E474K
1	C8	CAP, SMD, 0603, 0.22 μ F, 25V, 20%, X7R, ROHS	VISHAY	VJ0603X224MXXAT
2	C9, C23	CAP, SMD, 0402, 1000pF, 50V, 5%, COG, ROHS	MURATA	GRM1555C1H102JA01D
1	D1	LED, SMD, 3mmx2.5mm, 4P, RED/GREEN, 12/20MCD, 2V	LUMEX	SSL-LXA3025IGC-TR
1	D3	DIODE, SCHOTTKY, DUAL, SOT23, 30V, 200mA	FAIRCHILD	BAT54S
1	D5	DIODE-SCHOTTKY, SMB, 40V, 3A, LOW-VF, ROHS	DIODES INC.	B340LB-13-F
4	J1 to J4	TERMINAL, TURRET-POST, TH, ROHS	KEYSTONE	1514-2
2	J5, J6	PLUG, BANANA, THRU-HOLE, RED, 4.23mm, ROHS	MOUSER	164-6219
2	J7, J8	PLUG, BANANA, THRU-HOLE, BLKD, 4.23mm, ROHS	MOUSER	164-6218
1	JP1	HEADER, 2x3, BRKAWY 2x36, 2.54mm, ST	BERG/FCI	67996-272
7	JP2 to JP8	HEADER, 1x2, RETENTIVE, 2.54mm, ST, ROHS	BERG/FCI	69190-202
10	JP1(1 to 2, 3 to 4, 5 to 6), JP2 to JP8	JUMPER, 2 PIN, HIGHBDY, SHUNT	BERG/FCI	71363-102
1	L1	INDUCTOR, SMD, 13mm, 2.2 μ H, 20%, 29A, SHIELDED	VISHAY	IHLP5050CEER2R2M01
5	Q1, Q2, Q3, Q6, Q7	MOSFET, N-CH, SMD, 3P, SOT23, 50V, 0.2A, Pb-free	DIODES INC.	BSS138-7-F
1	Q4	MOSFET, N-CH, DUAL, 8P, SOIC, 30V, 17m Ω	FAIRCHILD	FDS6982AS
1	Q5	MOSFET, N-CH, SMD, TO-252AA, 30V, 7m Ω	VISHAY	SUD50N03-07
1	R1	RES, SMD, 0402, 49.9k, 1/16W, 1%, TF, ROHS	PANASONIC	ERJ-2RKF4992
2	R12, R17	RES, SMD, 0402, 57.6k, 1/16W, 1%, TF, ROHS	PANASONIC	ERJ-2RKF5762X
1	R13	RES, SMD, 0402, 6.49k, 1/16W, 1%, TF, ROHS	YAGEO	RC0402FR-076K49L
1	R14	RES, SMD, 0805, 4.7 Ω , 1/8W, 5%, TF, ROHS	PANASONIC	ERJ-6GEYJ4R7V
1	R16	RES, SMD, 0402, 19.1k, 1/16W, 1%, TF, ROHS	PANASONIC	ERJ-2RKF1912
1	R18	RES, SMD, 0402, 0 Ω , 1/16W, 5%, TF, ROHS	PANASONIC	ERJ-2GE0JR00
1	R19	RES, SMD, 0402, 3.01k, 1/16W, 1%, TF, ROHS	PANASONIC	ERJ-2RKF3011
4	R2, R6, R10, R11	RES, SMD, 0603, 249 Ω , 1/16W, 1%, TF, ROHS	PANASONIC	ERJ-3EKF2490
1	R20	RES, SMD, 0402, 3.57k, 1/16W, 1%, TF, ROHS	PANASONIC	ERJ-2RKF3571X
6	R28 to R33	RES, SMD, 1206, 1.43 Ω , 1/4W, 1%, TF, ROHS	YAGEO	RC1206FR-071R43L
1	R3	RES, SMD, 0402, 100k, 1/16W, 1%, TF, ROHS	PANASONIC	ERJ2RKF1003
7	R4, R7, R8, R21 to R24	RES, SMD, 0402, 10k, 1/16W, 1%, TF, ROHS	PANASONIC	ERJ-2RKF1002
1	R5	RES, SMD, 0402, 499 Ω , 1/16W, 1%, TF, ROHS	PANASONIC	ERJ-2RKF4990X
1	R9	RES, SMD, 0402, 150k, 1/16W, 1%, TF, ROHS	YAGEO	RC0402FR-07150KL

Bill of Materials (Continued)

QTY	REFERENCE	DESCRIPTION/COMMENT	MFG NAME	MFG NUMBER
5	S1 to S5	SWITCH-TOGGLE, SMD, ULTRAMINI, 1P, SPST, MINI	C&K COMPONENTS	GT11MSCKE
7	TP1 to TP5, TP21, TP24	COMPACT TEST PT, VERTICAL, BLK, ROHS	KEYSTONE	5006
1	TP27	COMPACT TEST PT, VERTICAL, WHT, ROHS	KEYSTONE	5007
4	TP6, TP19, TP25, TP26	SCOPE PROBE TEST POINT, PCB MNT	TEKTRONIX	131-4353-00
5	TP7, TP8, TP18, TP20, TP23	COMPACT TEST PT, VERTICAL, RED, ROHS	KEYSTONE	5005
10	TP9 to TP17, TP22	MINI TEST POINT, SMD	KEYSTONE	5015
1	U1	IC-GPU CONTROLLER, 16P, QFN, 4x4, Pb-free	INTERSIL	ISL6269ACRZ
1	U2	IC-HI FREQ BRIDGE DRIVER, 8P, SOIC, 100V	INTERSIL	HIP2100IB

Notice

1. Descriptions of circuits, software and other related information in this document are provided only to illustrate the operation of semiconductor products and application examples. You are fully responsible for the incorporation or any other use of the circuits, software, and information in the design of your product or system. Renesas Electronics disclaims any and all liability for any losses and damages incurred by you or third parties arising from the use of these circuits, software, or information.
2. Renesas Electronics hereby expressly disclaims any warranties against and liability for infringement or any other claims involving patents, copyrights, or other intellectual property rights of third parties, by or arising from the use of Renesas Electronics products or technical information described in this document, including but not limited to, the product data, drawings, charts, programs, algorithms, and application examples.
3. No license, express, implied or otherwise, is granted hereby under any patents, copyrights or other intellectual property rights of Renesas Electronics or others.
4. You shall not alter, modify, copy, or reverse engineer any Renesas Electronics product, whether in whole or in part. Renesas Electronics disclaims any and all liability for any losses or damages incurred by you or third parties arising from such alteration, modification, copying or reverse engineering.
5. Renesas Electronics products are classified according to the following two quality grades: "Standard" and "High Quality". The intended applications for each Renesas Electronics product depends on the product's quality grade, as indicated below.
"Standard": Computers; office equipment; communications equipment; test and measurement equipment; audio and visual equipment; home electronic appliances; machine tools; personal electronic equipment; industrial robots; etc.
"High Quality": Transportation equipment (automobiles, trains, ships, etc.); traffic control (traffic lights); large-scale communication equipment; key financial terminal systems; safety control equipment; etc.
Unless expressly designated as a high reliability product or a product for harsh environments in a Renesas Electronics data sheet or other Renesas Electronics document, Renesas Electronics products are not intended or authorized for use in products or systems that may pose a direct threat to human life or bodily injury (artificial life support devices or systems; surgical implantations; etc.), or may cause serious property damage (space system; undersea repeaters; nuclear power control systems; aircraft control systems; key plant systems; military equipment; etc.). Renesas Electronics disclaims any and all liability for any damages or losses incurred by you or any third parties arising from the use of any Renesas Electronics product that is inconsistent with any Renesas Electronics data sheet, user's manual or other Renesas Electronics document.
6. When using Renesas Electronics products, refer to the latest product information (data sheets, user's manuals, application notes, "General Notes for Handling and Using Semiconductor Devices" in the reliability handbook, etc.), and ensure that usage conditions are within the ranges specified by Renesas Electronics with respect to maximum ratings, operating power supply voltage range, heat dissipation characteristics, installation, etc. Renesas Electronics disclaims any and all liability for any malfunctions, failure or accident arising out of the use of Renesas Electronics products outside of such specified ranges.
7. Although Renesas Electronics endeavors to improve the quality and reliability of Renesas Electronics products, semiconductor products have specific characteristics, such as the occurrence of failure at a certain rate and malfunctions under certain use conditions. Unless designated as a high reliability product or a product for harsh environments in a Renesas Electronics data sheet or other Renesas Electronics document, Renesas Electronics products are not subject to radiation resistance design. You are responsible for implementing safety measures to guard against the possibility of bodily injury, injury or damage caused by fire, and/or danger to the public in the event of a failure or malfunction of Renesas Electronics products, such as safety design for hardware and software, including but not limited to redundancy, fire control and malfunction prevention, appropriate treatment for aging degradation or any other appropriate measures. Because the evaluation of microcomputer software alone is very difficult and impractical, you are responsible for evaluating the safety of the final products or systems manufactured by you.
8. Please contact a Renesas Electronics sales office for details as to environmental matters such as the environmental compatibility of each Renesas Electronics product. You are responsible for carefully and sufficiently investigating applicable laws and regulations that regulate the inclusion or use of controlled substances, including without limitation, the EU RoHS Directive, and using Renesas Electronics products in compliance with all these applicable laws and regulations. Renesas Electronics disclaims any and all liability for damages or losses occurring as a result of your noncompliance with applicable laws and regulations.
9. Renesas Electronics products and technologies shall not be used for or incorporated into any products or systems whose manufacture, use, or sale is prohibited under any applicable domestic or foreign laws or regulations. You shall comply with any applicable export control laws and regulations promulgated and administered by the governments of any countries asserting jurisdiction over the parties or transactions.
10. It is the responsibility of the buyer or distributor of Renesas Electronics products, or any other party who distributes, disposes of, or otherwise sells or transfers the product to a third party, to notify such third party in advance of the contents and conditions set forth in this document.
11. This document shall not be reprinted, reproduced or duplicated in any form, in whole or in part, without prior written consent of Renesas Electronics.
12. Please contact a Renesas Electronics sales office if you have any questions regarding the information contained in this document or Renesas Electronics products.
(Note 1) "Renesas Electronics" as used in this document means Renesas Electronics Corporation and also includes its directly or indirectly controlled subsidiaries.
(Note 2) "Renesas Electronics product(s)" means any product developed or manufactured by or for Renesas Electronics.

(Rev.4.0-1 November 2017)



SALES OFFICES

Renesas Electronics Corporation

<http://www.renesas.com>

Refer to "<http://www.renesas.com/>" for the latest and detailed information.

Renesas Electronics America Inc.
1001 Murphy Ranch Road, Milpitas, CA 95035, U.S.A.
Tel: +1-408-432-8888, Fax: +1-408-434-5351

Renesas Electronics Canada Limited
9251 Yonge Street, Suite 8309 Richmond Hill, Ontario Canada L4C 9T3
Tel: +1-905-237-2004

Renesas Electronics Europe Limited
Dukes Meadow, Millboard Road, Bourne End, Buckinghamshire, SL8 5FH, U.K
Tel: +44-1628-651-700, Fax: +44-1628-651-804

Renesas Electronics Europe GmbH
Arcadiastrasse 10, 40472 Düsseldorf, Germany
Tel: +49-211-6503-0, Fax: +49-211-6503-1327

Renesas Electronics (China) Co., Ltd.
Room 1709 Quantum Plaza, No.27 ZhichunLu, Haidian District, Beijing, 100191 P. R. China
Tel: +86-10-8235-1155, Fax: +86-10-8235-7679

Renesas Electronics (Shanghai) Co., Ltd.
Unit 301, Tower A, Central Towers, 555 Langao Road, Putuo District, Shanghai, 200333 P. R. China
Tel: +86-21-2226-0888, Fax: +86-21-2226-0999

Renesas Electronics Hong Kong Limited
Unit 1601-1611, 16/F., Tower 2, Grand Century Place, 193 Prince Edward Road West, Mongkok, Kowloon, Hong Kong
Tel: +852-2265-6688, Fax: +852-2886-9022

Renesas Electronics Taiwan Co., Ltd.
13F, No. 363, Fu Shing North Road, Taipei 10543, Taiwan
Tel: +886-2-8175-9600, Fax: +886-2-8175-9670

Renesas Electronics Singapore Pte. Ltd.
80 Bendemeer Road, Unit #06-02 Hyflux Innovation Centre, Singapore 339949
Tel: +65-6213-0200, Fax: +65-6213-0300

Renesas Electronics Malaysia Sdn.Bhd.
Unit 1207, Block B, Menara Amcorp, Amcorp Trade Centre, No. 18, Jln Persiaran Barat, 46050 Petaling Jaya, Selangor Darul Ehsan, Malaysia
Tel: +60-3-7955-9390, Fax: +60-3-7955-9510

Renesas Electronics India Pvt. Ltd.
No.777C, 100 Feet Road, HAL 2nd Stage, Indiranagar, Bangalore 560 038, India
Tel: +91-80-67208700, Fax: +91-80-67208777

Renesas Electronics Korea Co., Ltd.
17F, KAMCO Yangjae Tower, 262, Gangnam-daero, Gangnam-gu, Seoul, 06265 Korea
Tel: +82-2-558-3737, Fax: +82-2-558-5338