

ISL6420AEVALxZ

Using the ISL6420A PWM Controller Evaluation Board

AN1179
Rev 1.00
Sep 15, 2006

Advanced Single Synchronous Buck Pulse-Width Modulation (PWM) Controller

The ISL6420A simplifies the implementation of a complete control and protection scheme for a high-performance DC/DC buck converter. It is designed to drive N-channel MOSFETs in a synchronous rectified buck topology. The control, output adjustment, monitoring and protection functions into a single package.

The ISL6420A provides simple, single feedback loop, voltage mode control with fast transient response. The output voltage of the converter can be precisely regulated to as low as 0.6V, with a maximum tolerance of $\pm 1.0\%$ over temperature and line voltage variations.

The operating frequency is fully adjustable from 100kHz to 1.4MHz. High frequency operation offers cost and space savings.

The error amplifier features a 15MHz gain-bandwidth product and 6V/ μ s slew rate that enables high converter bandwidth for fast transient response. The resulting PWM duty cycle ranges from 0% to 100%. The capacitor value from the ENSS pin to ground sets the time duration for the PWM soft-start. Pulling the ENSS pin LOW disables the controller.

The ISL6420A monitors the output voltage and generates a PGOOD (power good) signal when soft-start is complete and the output is within regulation. A built-in overvoltage protection circuit prevents the output voltage from going above typically 115% of the set point. Protection from overcurrent conditions is provided by monitoring the $r_{DS(ON)}$ of the upper MOSFET to inhibit the PWM operation appropriately. This approach simplifies the implementation and improves efficiency by eliminating the need for a current sensing resistor. The IC also features voltage margining for networking DC/DC converter applications.

ISL6420A Reference Design

The ISL6420A evaluation boards illustrates the operation of the IC in an embedded application. Two versions of the evaluation board, based on the package type, are listed in Table 1. Both are configured for an output voltage of 3.3V and 10A maximum load.

TABLE 1.

BOARD NAME	IC	PACKAGE
ISL6420AEVAL1Z	ISL6420AIAZ	20 Ld QSSOP
ISL6420AEVAL3Z	ISL6420AIRZ	20 Ld QFN

Quick Start Evaluation

The evaluation board is shipped "ready to use" right from the box. Both boards have been optimized for a 12V input from a standard power supply but can accept a range from 4.5V to 5.5V or 5.5V to 28V as desired. Standoff terminals have been provided in order to connect the input source and the load.

Recommended Test Equipment

To test the functionality of the ISL6420A, the following equipment is recommended:

- An adjustable 30V, 8A capable bench power supply
- An electronic load
- Four channel oscilloscope with probes
- Precision digital multimeter

Power and Load Connections

JUMPER SETTING FOR ISL6420AEVAL1Z

Connect JP1 pin 1 to pin 2 for 5.5V to 28V operation and JP1 pin 2 to pin 3 for a 4.5V to 5.5V operation. JP2 and JP3, when shorted with a jumper, pull the GPIO2 and GPIO1 pins to GND. With the jumpers removed, GPIO2 and GPIO1 will be floating.

CAUTION: When JP1 pin 2 to pin 3 are connected, applying voltages >6V can damage the IC.

JUMPER SETTING FOR ISL6420AEVAL3Z

Connect power supply to the VIN terminal for a 5.5V to 28V operation and source to both VIN and +5V terminals for a 4.5V to 5.5V operation. JP2 and JP3, when shorted with a jumper, pull the GPIO2 and GPIO1 pins to GND. With the jumpers removed, GPIO2 and GPIO1 will be floating.

CAUTION: Ensure that the +5V terminal is not connected to when applying voltages >6V. This can damage the IC.

Input Voltage - The evaluation board is optimized for an input supply of 12V, however, the input supply based on the connection can range from 4.5V to 5.5V or 5.5V to 28V. In the use of the 5.5V to 28V range, an additional 5V source is not required.

If using an input supply ranging from 5.5V to 28V, the VIN post (P1) is connected to the drain of the upper MOSFET and the VIN pin of the IC. The chip is biased by the 5V output (VCC5, post P5) of the internal LDO.

When using a 5V $\pm 10\%$ input supply, connect the power supply to the VIN (P1) post and the VCC5 (P5) post. This will disable the internal LDO and the chip will be powered by the input power supply.

For quick start evaluation, adjust the power supply to the desired VIN. With the power supply turned off, connect the

positive lead to the VIN post (P1) and the ground lead to the GND post (P2).

Output Voltage Loading and Monitoring - Connect the positive lead of the electronic load and the positive lead of a digital multimeter to the VOUT post (P3) and the ground lead to the GND post (P4). You can use the scope probe terminal (SC1) to monitor VOUT with an oscilloscope.

Start-up

The Power On Reset (POR) function initiates the soft-start sequence. An internal 10µA current source charges an external capacitor connected to the ENSS (P9) pin from 0V to 3.3V. When the ENSS pin reaches 1V, the error amplifier reference voltage ramps from 0V to 0.6V following the slope of the ENSS pin voltage.

There are two distinct start-up methods for the ISL6420A. The first method is invoked through the application of power to the IC. The soft-start feature allows for a controlled turn-on of the output once the POR threshold of the input voltage has been reached. Figure 1 shows the start-up profile of the regulator in relation to the start-up of the input supply.

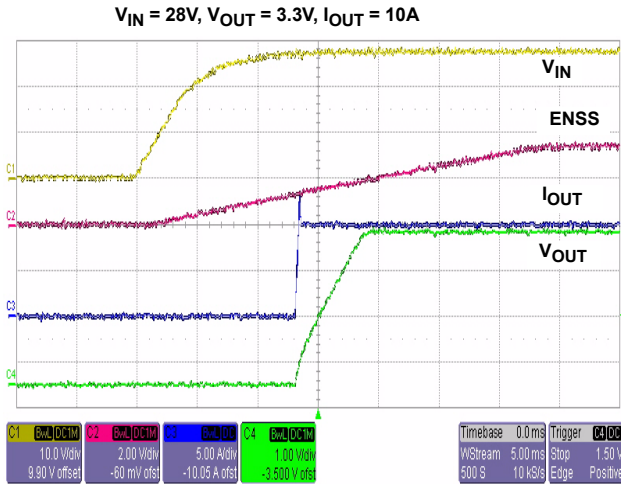

FIGURE 1. SOFT-START

The second method of start-up is through the use of the enable feature. Holding the ENSS (P9) pin on the ISL6420A below 1V will disable the regulator by forcing both the upper and lower MOSFETs off. Releasing the pin allows the regulator to start-up.

Shutdown

If the ENSS pin is pulled down and held below 1V, the regulator will be turned off. Figure 2 shows the shutdown profile of the regulator with the ENSS pin pulled low. Figure 3 shows the shutdown of the regulator when powering down the input supply.

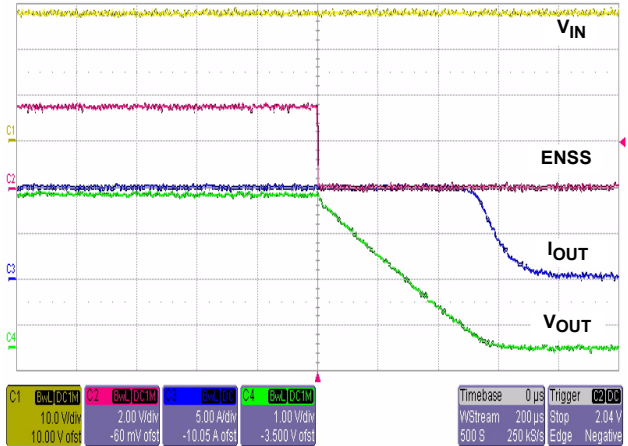

FIGURE 2. SHUTDOWN USING ENSS

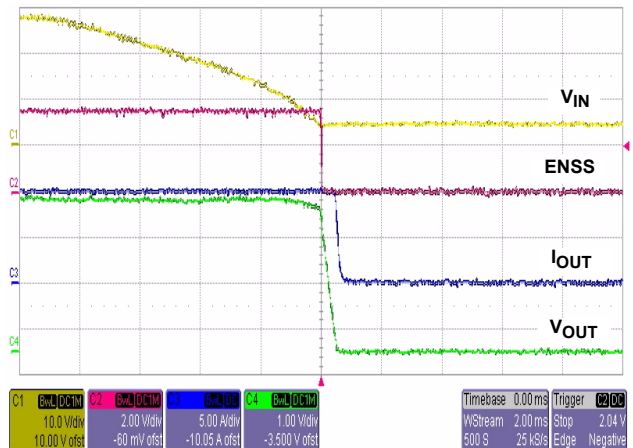

FIGURE 3. POWER-DOWN OF VIN

Output Performance

Switching Frequency

The evaluation board has a 0Ω resistor R9 connecting RT to VCC5 setting the free-running switching frequency to 300kHz. The frequency can be programmed to a different value by removing R9 and populating the R4 location with a resistor value based on the desired frequency.

Output Ripple

Figure 4 shows the ripple voltage on the output of the regulator at the free running 300kHz frequency.

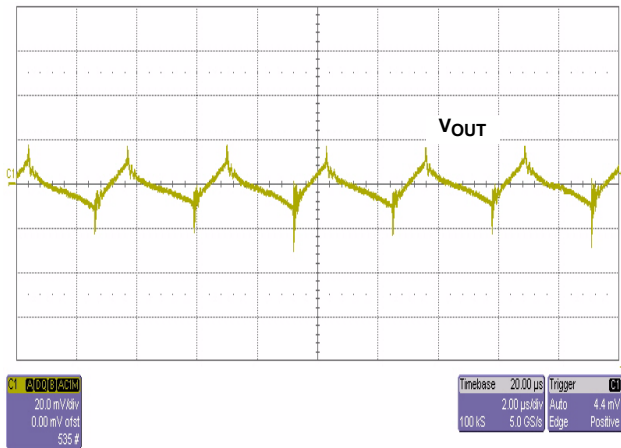

FIGURE 4. OUTPUT RIPPLE

Efficiency

ISL6420A-based regulators enable the design of highly efficient systems. The efficiency of the evaluation board using a 12V and a 28V input supply is shown in Figure 5.

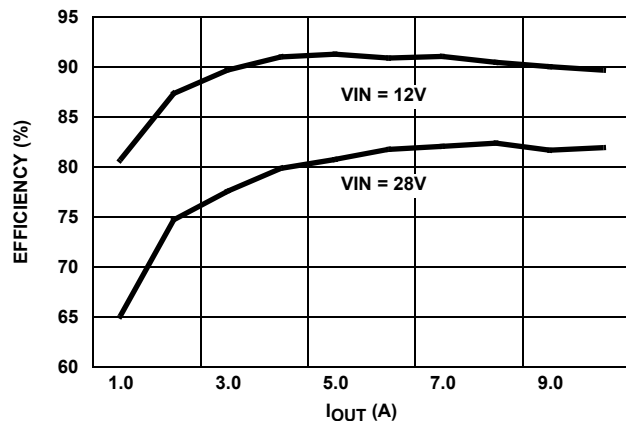

FIGURE 5. EVALUATION BOARD EFFICIENCY (VOUT = 3.3V)

Power Good

PGOOD will be true (open drain) when the FB pin voltage is within ±10% of the reference voltage and the soft-start sequence is complete, i.e., once the soft-start capacitor is

finished charging. The status of PGOOD can be monitored at the PGOOD test point (TP1).

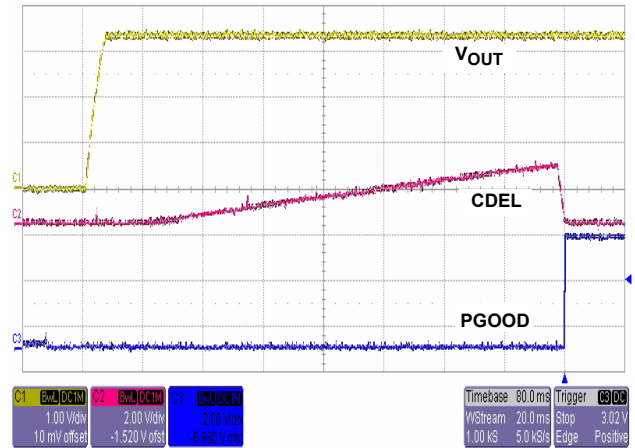

FIGURE 6. PGOOD

Overcurrent Protection

The overcurrent function cycles the soft-start function in a hiccup mode to provide fault protection. Figure 7 shows the overcurrent hiccup mode.

The overcurrent function protects the converter from a shorted output by using the upper MOSFET's $r_{DS(ON)}$ to monitor the current. This method enhances the converter's efficiency and reduces cost by eliminating a current sensing resistor.

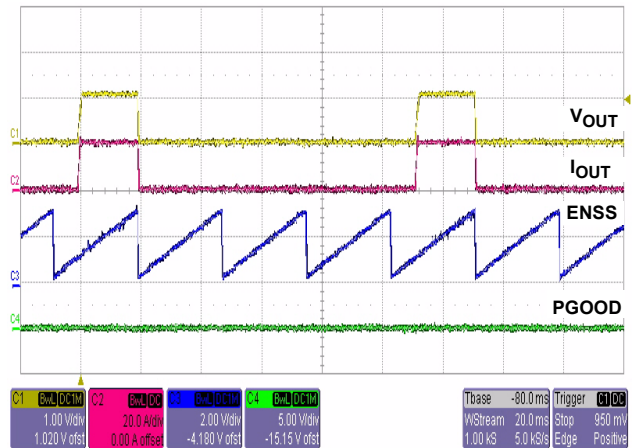

FIGURE 7. OVERCURRENT HICCUP MODE

A resistor, ROCSET (R8), programs the overcurrent trip level. The PHASE node voltage is compared to the voltage on the OCSET pin while the upper FET is on. A current (100μA typically) is pulled from the OCSET pin to establish this voltage across an external resistor. If PHASE is lower than OCSET, while the upper FET is on, then an overcurrent condition is detected for that clock cycle. The pulse is immediately terminated, and a counter is incremented. If an overcurrent condition is detected for 8 consecutive clock cycles, and the circuit is not in soft-start, the ISL6420A enters into hiccup mode. During hiccup, the external

capacitor on the ENSS pin is discharged and soft-start is initiated. During soft-start, pulse termination limiting is enabled, but the 8-cycle hiccup counter is held in reset until soft-start is completed.

The overcurrent function will trip at a peak inductor current (I_{PEAK}) determined by,

$$I_{PEAK} = \frac{I_{OCSET} \cdot R_{OCSET}}{R_{DS(ON)}}$$

where I_{OCSET} is the internal OCSET current source.

The OC trip point varies mainly due to the MOSFET's $r_{DS(ON)}$ variations. To avoid overcurrent tripping in the normal operating load range, calculate the R_{OCSET} resistor from the equation above using:

1. The maximum $r_{DS(ON)}$ at the highest junction temperature
2. The minimum I_{OCSET} from the specification table

Determine I_{PEAK} for $I_{PEAK} > I_{OUT(MAX)} + (\Delta I)/2$,

where ΔI is the output inductor ripple current. A small ceramic capacitor should be placed in parallel with R_{OCSET} to smooth the voltage across R_{OCSET} in the presence of switching noise on the input voltage.

The overcurrent trip point on the evaluation board has been set to 16A. Figure 7 shows the overcurrent hiccup mode.

Transient Performance

Figure 8 shows the response of the output when subjected to transient loading from 10mA to 10A.

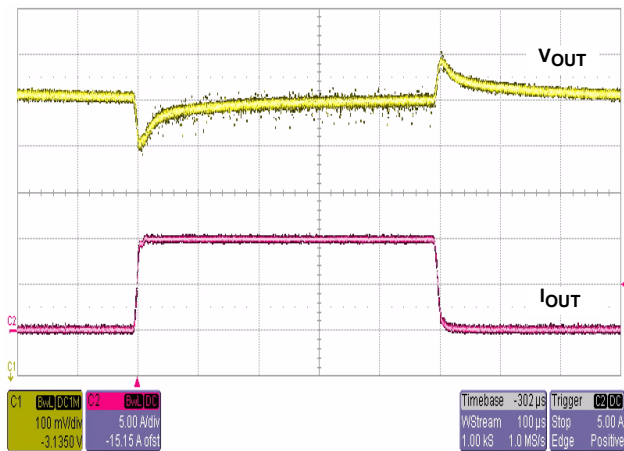

FIGURE 8. TRANSIENT RESPONSE

Voltage Margining

Voltage margining mode is enabled by connecting a margining set resistor ($R6$) from the VMSET pin to ground. This resistor to ground will set a current, which is switched to the FB pin. The current will be equal to 2.468V divided by the value of the external resistor tied to the VMSET pin.

The GPIO1 (P8) and GPIO2 (P7) pins control the current switching as per Table 2. The power supply output increases when GPIO2 is HIGH and decreases when GPIO1 is HIGH. Using a jumper to short the pins of JP2 and JP3 will pull GPIO2 and GPIO1 LOW, respectively. Remove one of the jumpers to pull GPIO1 or GPIO2 HIGH for voltage margining. The amount that the output voltage of the power supply changes with voltage margining will be equal to 2.468V times the ratio of the external feedback resistor ($R2$) and the external resistor tied to VMSET ($R6$).

TABLE 2.

GPIO1	GPIO2	V _{OUT}
L	L	No Change
L	H	+ Delta V _{OUT}
H	L	- Delta V _{OUT}
H	H	Ignored

The evaluation board has a 330kΩ VMSET resistor ($R6$) setting a current:

$$I_{VM} = 2.468V/330k\Omega = 7.48\mu A$$

and

$$V(\Delta) = 7.48\mu A * 20.5k\Omega = 0.153V$$

Figure 9 shows the output voltage in voltage margining mode for various VMSET resistor values.

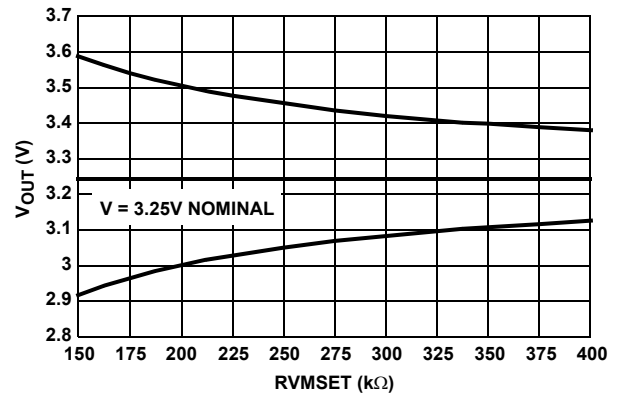

FIGURE 9. CHANGE IN OUTPUT VOLTAGE FOR VARIOUS RESISTORS

The slew time of the current is set by an external capacitor ($C13$) on the CDEL pin, which is charged and discharged with a 100μA current source. The change in voltage on the capacitor is 2.5V. This same capacitor is also used to set the PGOOD rise delay. When PGOOD is low, the internal PGOOD circuitry uses the capacitor and when PGOOD is high the voltage margining circuit uses the capacitor. The slew time for voltage margining can be in the range of 300μs to 2.5ms. The CDEL capacitor on the evaluation board is 0.1μF leading to a voltage margining slew rate of 2.5ms.

Figures 10 and 11 show negative and positive voltage margining with a CDEL capacitor of 0.1 μ F.

$V_{IN} = 12V$, $V_{OUT} = 3.3V$, NO LOAD

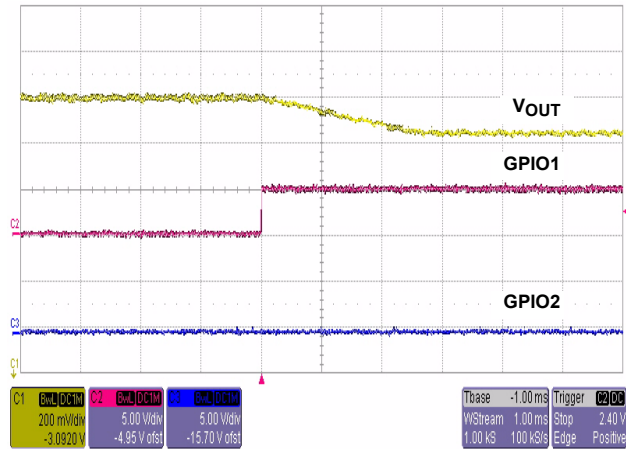

FIGURE 10. NEGATIVE VOLTAGE MARGINING SLEW TIME

$V_{IN} = 12V$, $V_{OUT} = 3.3V$, NO LOAD

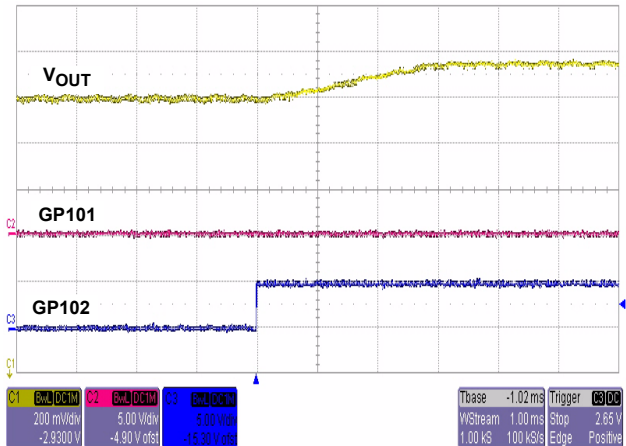

FIGURE 11. POSITIVE VOLTAGE MARGINING SLEW TIME

Layout Guidelines

DC to DC converter layout is extremely important to obtain the desired attenuation to the EMI frequencies. Poor layout practice can cause conducted emissions to actually couple around the filter components directly into the input conductors or cause radiated emissions. The copper traces of power input and output and high current paths must be sized according to the RMS current passing through them. Keep the high current loops small and the path defined. Use single point grounding. Capacitor lead length must be minimized as much as possible to reduce ESL. This includes the traces on the PC board leading up to the capacitor pads. Based on the layout, voltage transients may reduce the level of the acceptable max V_{IN} when operating close to 28V. In this case, one can consider the use of snubbers or reduce the max V_{IN} . Use of a GND plane in a multilayered board is preferred.

Conclusion

The ISL6420A is a versatile PWM controller. The small footprint and the numerous features enables the implementation of compact and highly efficient regulators, delivering low voltage power solutions.

References

For Intersil documents available on the web, see <http://www.intersil.com/>

- [1] *ISL6420A Data Sheet*, Intersil Corporation, File No. FN9073.

ISL6420AEVAL1Z Schematic

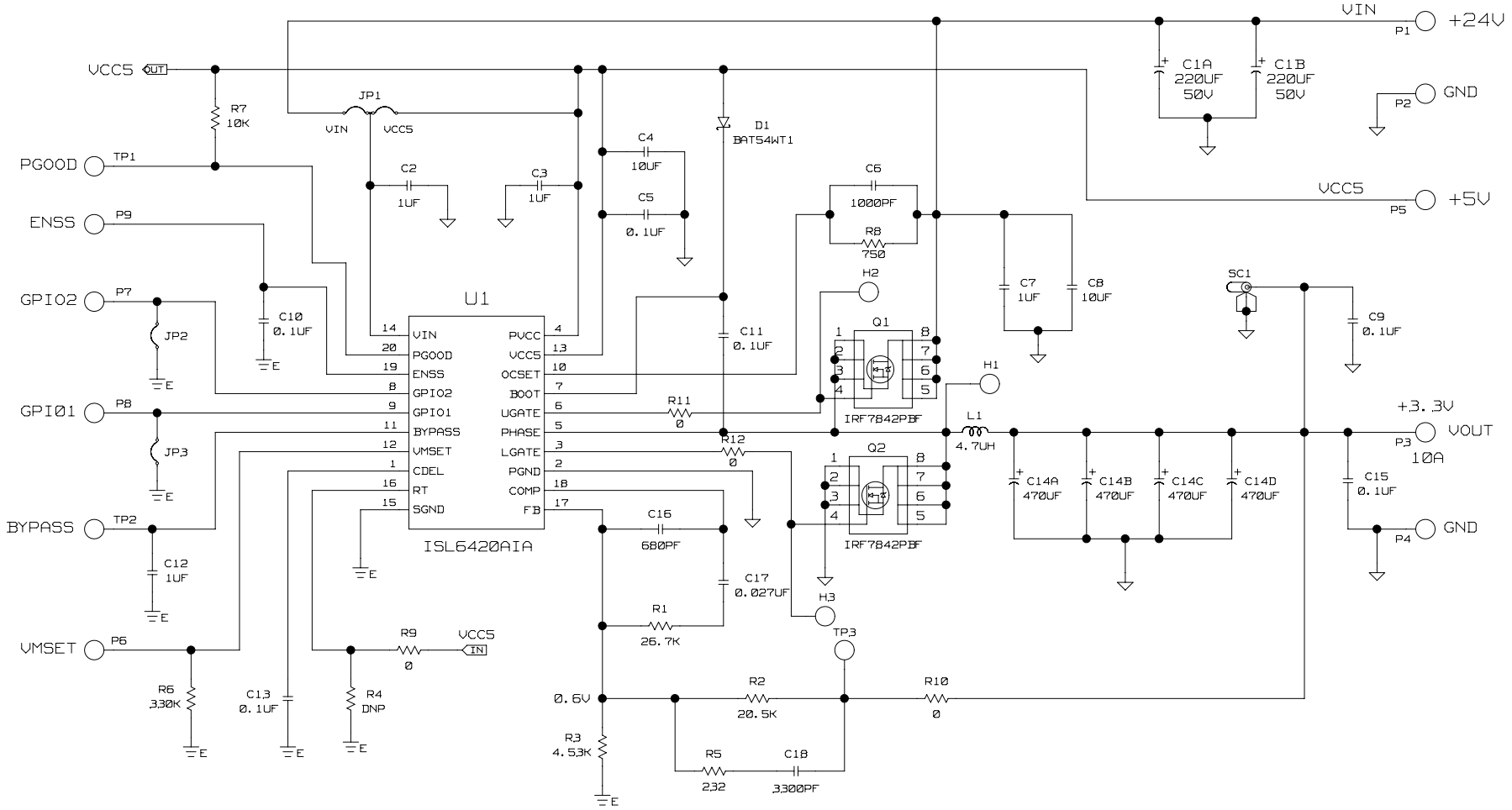

ISL6420AEVAL1Z Rev. A Bill of Materials

ID	REFERENCE	QTY	PART NUMBER	PART TYPE	DESCRIPTION	PACKAGE	VENDOR
1	U1	1	ISL6420AIAZ	IC, Linear	IC, Single PWM Controller	20 Ld QSOP	Intersil
2	Q1, Q2	2	IRF7842PBF	MOSFET, Single	N-channel, 40V, 18A	SO-8	International Rectifier
3	D1	1	BAT54WT-7-F	Diode, Schottky	30V, 200mA	SOT-323	Diode Inc.
4	L1	1	IHLP-5050CEE4R7M01	Inductor	4.7 μ H, 20%, 24A	SMD	Vishay
CAPACITORS							
5	C1A, C1B	2	EEUFC1H221S	Capacitor, Alum. Elec.	220 μ F, 20%, 50V, 1150mA	12.5 X 15	Panasonic
6	C2, C7	2	C3216X7R1H105K	Capacitor, Ceramic, X7R	1.0 μ F, 10%, 50V	SM_1206	TDK/Generic
7	C3, C12	2	C2012X7R1E105K	Capacitor, Ceramic, X7R	1.0 μ F, 10%, 25V	SM_0805	TDK/Generic
8	C4	1	C3225X7R1E106M	Capacitor, Ceramic, X7R	10 μ F, 20%, 25V	SM_1210	TDK/Generic
9	C5, C9, C10, C11, C13, C15	6	C1608X7R1E104K	Capacitor, Ceramic, X7R	0.1 μ F, 10%, 25V	SM_0603	TDK/Generic
10	C6	1	C1608X7R1H102K	Capacitor, Ceramic, X7R	1000pF, 10%, 50V	SM_0603	TDK/Generic
11	C8	1	C5750X7R1H106M	Capacitor, Ceramic, X7R	10 μ F, 20%, 50V	SM_2220	TDK/Generic
12	C14A, C14B, C14C, C14D	4	6TPB470M	Capacitor, POSCAP	470 μ F, 20%, 6.3V, 0.035 Ω	Case D4	SANYO
13	C16	1	C1608COG1H681JT	Capacitor, Ceramic, X7R	680pF, 10%, 25V	SM_0603	TDK/Generic
14	C17	1	C1608X7R1E273K	Capacitor, Ceramic, X7R	0.027 μ F, 10%, 25V	SM_0603	TDK/Generic
15	C18	1	C1608X7R1E332K	Capacitor, Ceramic, X7R	3300pF, 10%, 25V	SM_0603	TDK/Generic
RESISTORS							
16	R1	1		Resistor, Film	26.7k Ω , 1%, 1/16W	SM_0603	Panasonic/Generic
17	R2	1		Resistor, Film	20.5k Ω , 1%, 1/16W	SM_0603	Panasonic/Generic
18	R3	1		Resistor, Film	4.53k Ω , 1%, 1/16W	SM_0603	Panasonic/Generic
19	R4	1	Do Not Populate	Resistor, Film		SM_0603	Panasonic/Generic
20	R5	1		Resistor, Film	232 Ω , 1%, 1/16W	SM_0603	Panasonic/Generic
21	R6	1		Resistor, Film	330k Ω , 1%, 1/16W	SM_0603	Panasonic/Generic
22	R7	1		Resistor, Film	10k Ω , 1%, 1/16W	SM_0603	Panasonic/Generic
23	R8	1		Resistor, Film	750 Ω , 1%, 1/16W	SM_0603	Panasonic/Generic
24	R9, R10, R11, R12	4		Resistor, Film	0 Ω , 1%, 1/16W	SM_0603	Panasonic/Generic
OTHERS							
25	SC1	1	Do Not Populate	Terminal, Scope Probe	Terminal, Scope Probe		Tektronix
26	P1 - P9	9	1514-2	Turret Post	Terminal post, through hole, 1/4 inch	PTH	Johnson
27	TP1, TP2, TP3	3	5002	TEST POINT vertical, white	PC test jack	PTH	Keystone
28	JP1	1	68000-236-1X3	Header	1X3 Break Strip GOLD		
29	JP2, JP3	2	68000-236-1X2	Header	1X2 Break Strip GOLD		
30	JP1, JP2, JP3	3	S9001-ND	Jumper	2 pin jumper		Digikey
31				Bumpers			

ISL6420AEVAL1Z Printed Circuit Board Layers

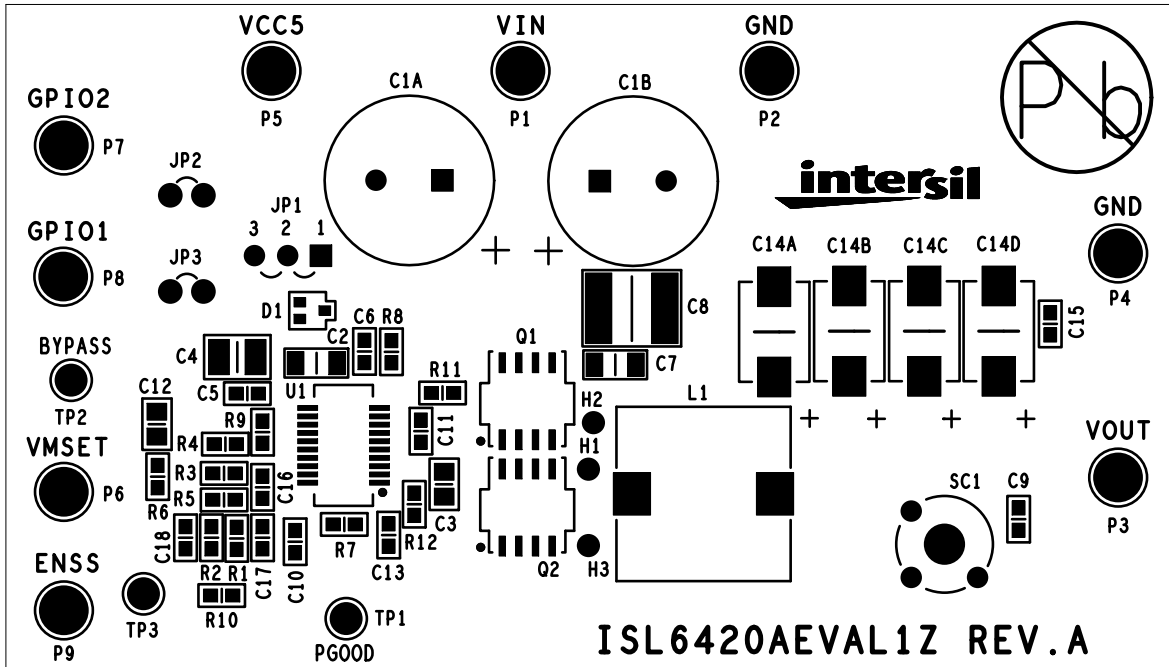

ISL6420AEVAL1Z - TOP LAYER (SILKSCREEN)

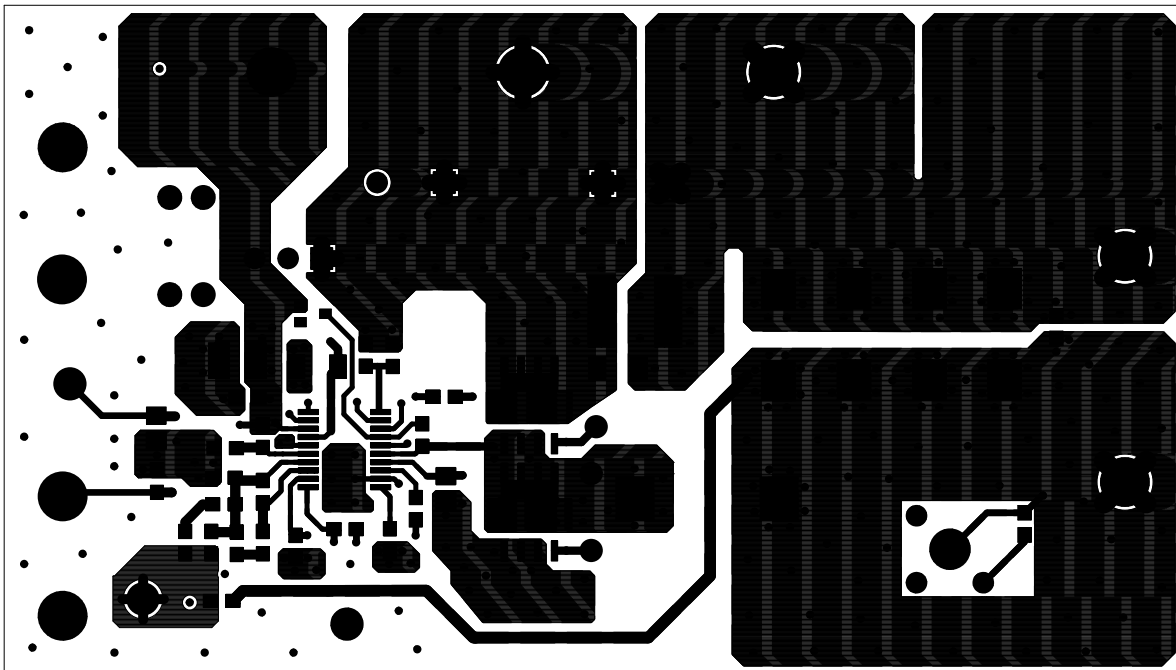

ISL6420AEVAL1Z - TOP LAYER (COMPONENT SIDE)

ISL6420AEVAL1Z Printed Circuit Board Layers (Continued)

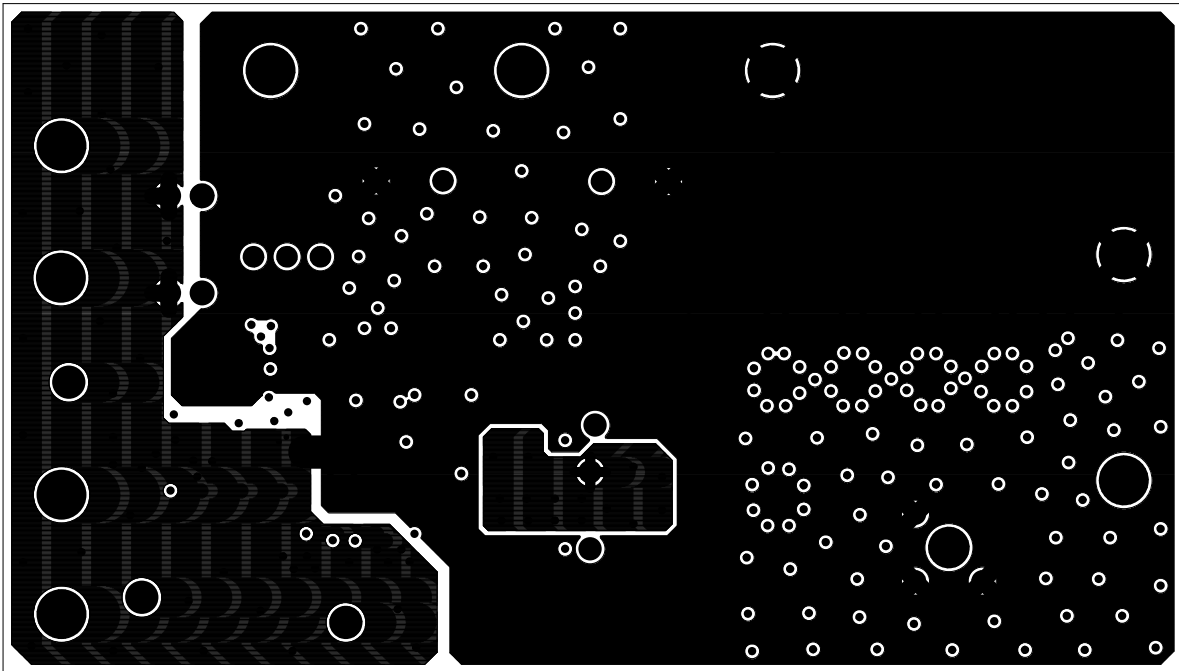

ISL6420AEVAL1Z - LAYER 2

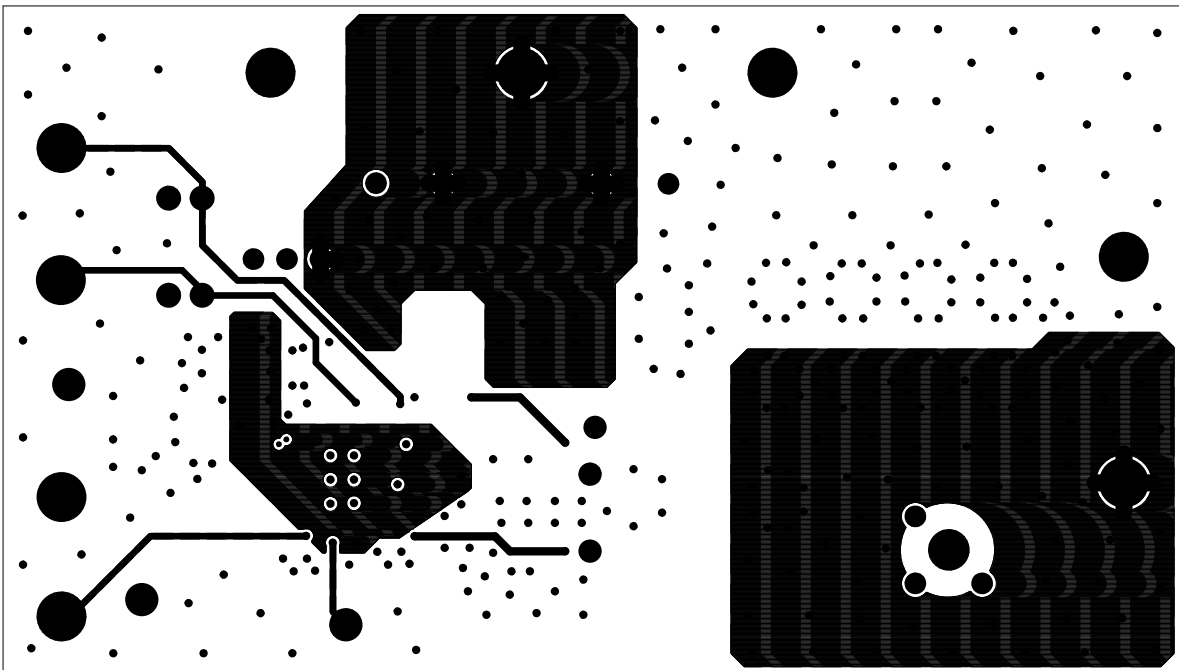

ISL6420AEVAL1Z - LAYER 3

ISL6420AEVAL1Z Printed Circuit Board Layers (Continued)

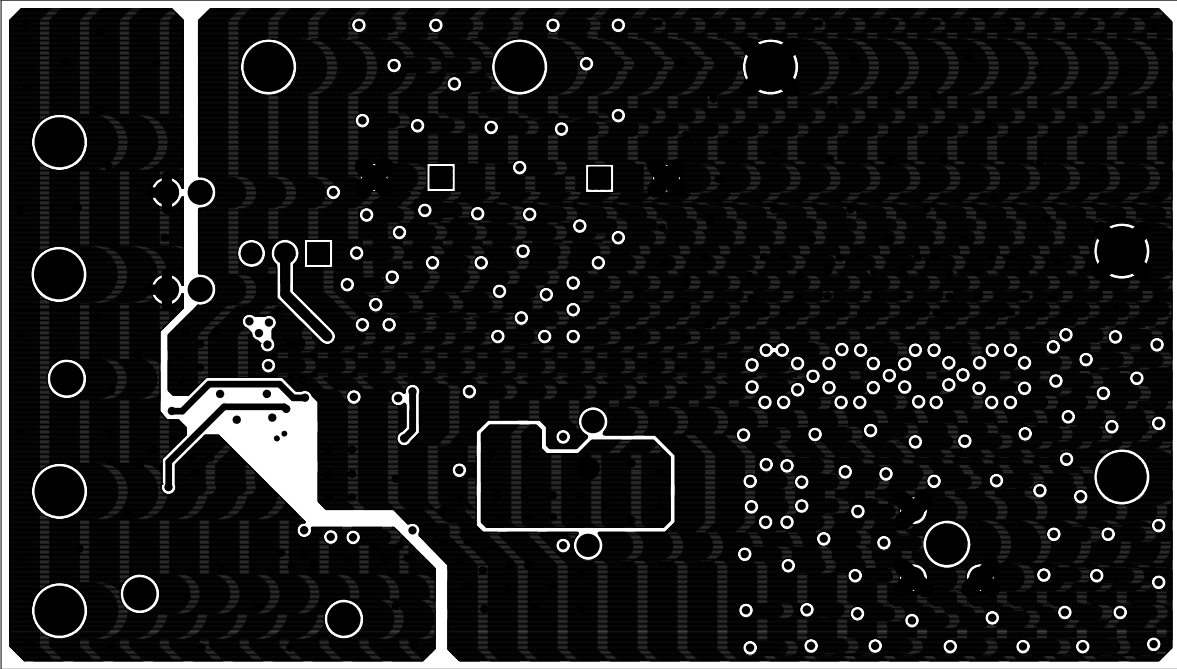

ISL6420AEVAL1Z - BOTTOM LAYER (SOLDER SIDE)

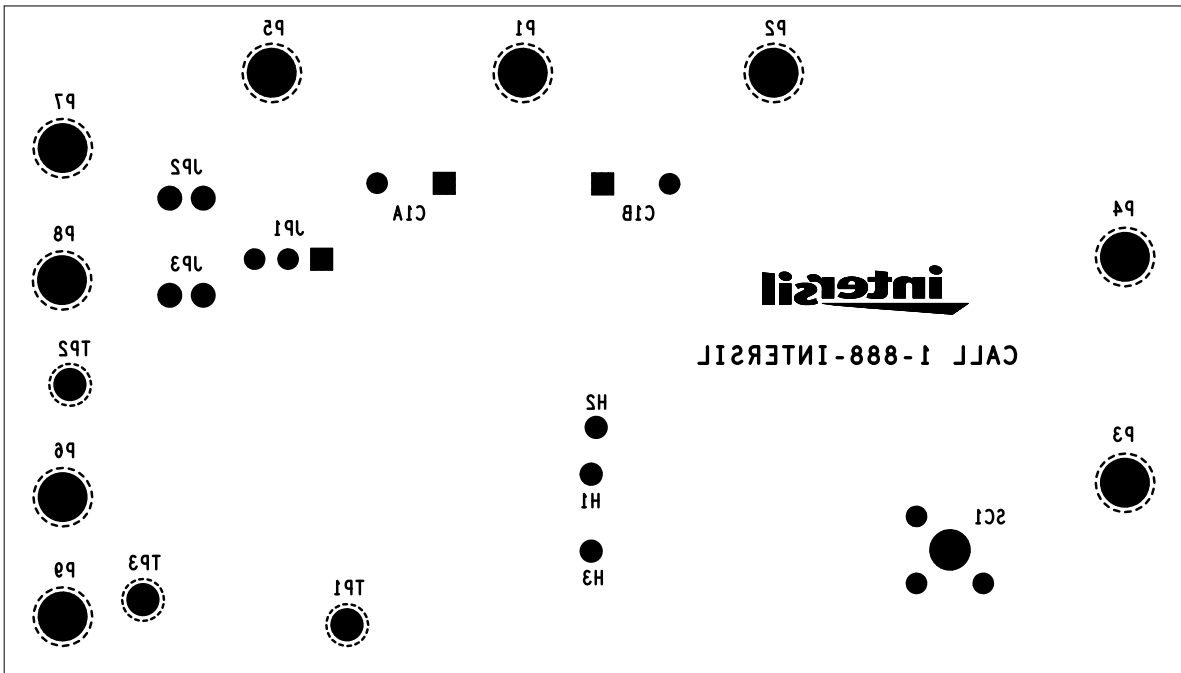

ISL6420AEVAL1Z - BOTTOM LAYER (SILKSCREEN)

ISL6420AEVAL3Z Rev. B Bill of Materials

ID	REFERENCE	QTY	PART NUMBER	PART TYPE	DESCRIPTION	PACKAGE	VENDOR
1	U1	1	ISL6420AIRZ	IC, Linear	IC, Single PWM Controller	20 Ld QFN	Intersil
2	Q1, Q2	2	IRF7842PBF	MOSFET, Single	N-channel, 40V, 18A	SO-8	International Rectifier
3	D1	1	BAT54WT-7-F-T	Diode, Schottky	30V, 200mA	SOT-323	Diode Inc.
4	D2	1	1SMA5.0AT3G	Diode, Voltage Suppressor	6.4V, 400mA	SMA	On Semi
5	L1	1	IHLP-5050CEEB4R7M01	Inductor	4.7 μ H, 20%, 24A	SMD	Vishay
CAPACITORS							
6	C1A, C1B	2	EEUFC1H221S	Capacitor, Alum. Elec.	220 μ F, 20%, 50V, 1150mA	Radial	Panasonic
7	C2, C7	2	C3216X7R1H105K	Capacitor, Ceramic, X7R	1.0 μ F, 10%, 50V	SM_1206	TDK/Generic
8	C3, C12	2	C2012X7R1E105K	Capacitor, Ceramic, X7R	1.0 μ F, 10%, 25V	SM_0805	TDK/Generic
9	C4	1	C3225X7R1E106M	Capacitor, Ceramic, X7R	10 μ F, 20%, 25V	SM_1210	TDK/Generic
10	C5, C9, C10, C11, C13, C15	6	C1608X7R1E104K	Capacitor, Ceramic, X7R	0.1 μ F, 10%, 25V	SM_0603	TDK/Generic
11	C6	1	C1608X7R1H102K	Capacitor, Ceramic, X7R	1000pF, 10%, 50V	SM_0603	TDK/Generic
12	C8	1	C5750X7R1H106M	Capacitor, Ceramic, X7R	10 μ F, 20%, 50V	SM_2220	TDK/Generic
13	C14A, C14B, C14C, C14D	4	6TPB470M	Capacitor, POSCAP	470 μ F, 20%, 6.3V, 0.035 Ω	Case D4	SANYO
14	C16	1	C1608X7R1E681K	Capacitor, Ceramic, X7R	680pF, 10%, 25V	SM_0603	TDK/Generic
15	C17	1	C1608X7R1E273K	Capacitor, Ceramic, X7R	0.027 μ F, 10%, 25V	SM_0603	TDK/Generic
16	C18	1	C1608X7R1E332K	Capacitor, Ceramic, X7R	3300pF, 10%, 25V	SM_0603	TDK/Generic
RESISTORS							
17	R1	1		Resistor, Film	26.7k Ω , 1%, 1/16W	SM_0603	TDK/Generic
18	R2	1		Resistor, Film	20.5k Ω , 1%, 1/16W	SM_0603	TDK/Generic
19	R3	1		Resistor, Film	4.53k Ω , 1%, 1/16W	SM_0603	TDK/Generic
20	R4 (DNP)	1	Do Not Populate	Resistor, Film		SM_0603	TDK/Generic
21	R5	1		Resistor, Film	232 Ω , 1%, 1/16W	SM_0603	TDK/Generic
22	R6	1		Resistor, Film	330k Ω , 1%, 1/16W	SM_0603	TDK/Generic
23	R7	1		Resistor, Film	10k Ω , 1%, 1/16W	SM_0603	TDK/Generic
24	R8	1		Resistor, Film	750 Ω , 1%, 1/16W	SM_0603	TDK/Generic
25	R9, R11	2		Resistor, Film	0 Ω , 1%, 1/16W	SM_0603	TDK/Generic
26	R10	1		Resistor, Film	10 Ω , 5%, 1/4W	SM_1210	TDK/Generic
OTHERS							
27	F1	1	419-0250-000	Fuse	Fuse, 250mA	SMT	Wickmann
28	SP1	1	Do Not Populate	Terminal, Scope Probe	Terminal, Scope Probe		Tektronix
29	P1 - P9	9	1514-2	Turret Post	Terminal post, through hole, 1/4 inch	PTH	Johnson
30	TP1, TP2, TP3, TP4	4	5002	TEST POINT vertical, white	PC test jack	PTH	Keystone
31	JP1, JP2	2	69190-202	Header	1X2 Break Strip GOLD		BERG/FCI
32	JP1, JP2	2	SPC02SYAN	Jumper	2 pin jumper		SULLINSSULLINS
33				Bumpers			

ISL6420AEVAL3Z Printed Circuit Board Layers

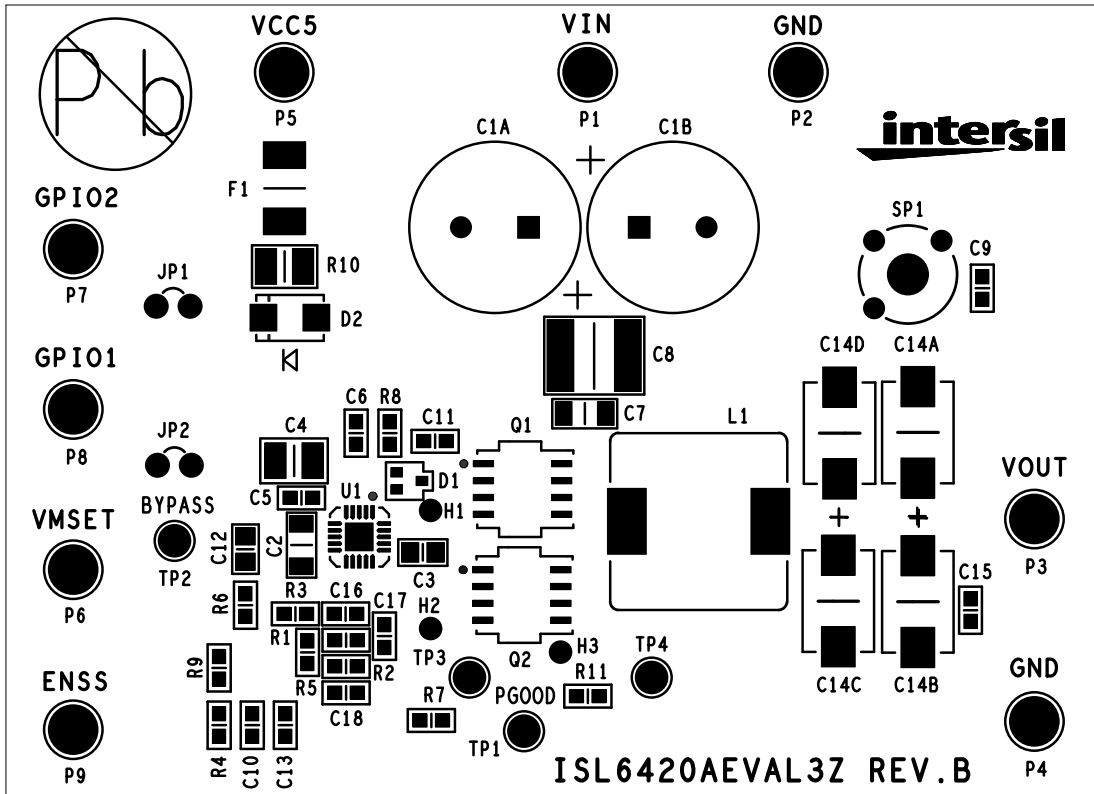

ISL6420AEVAL3Z - TOP LAYER (SILKSCREEN)

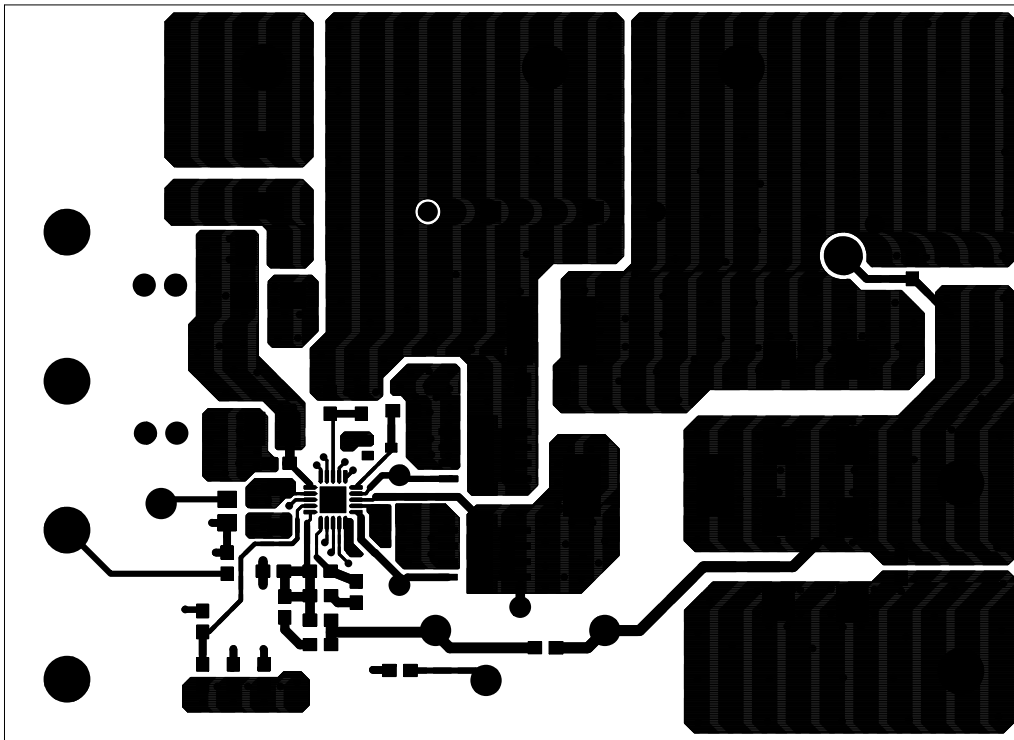

ISL6420AEVAL3Z - TOP LAYER (COMPONENT SIDE)

ISL6420AEVAL3Z Printed Circuit Board Layers (Continued)

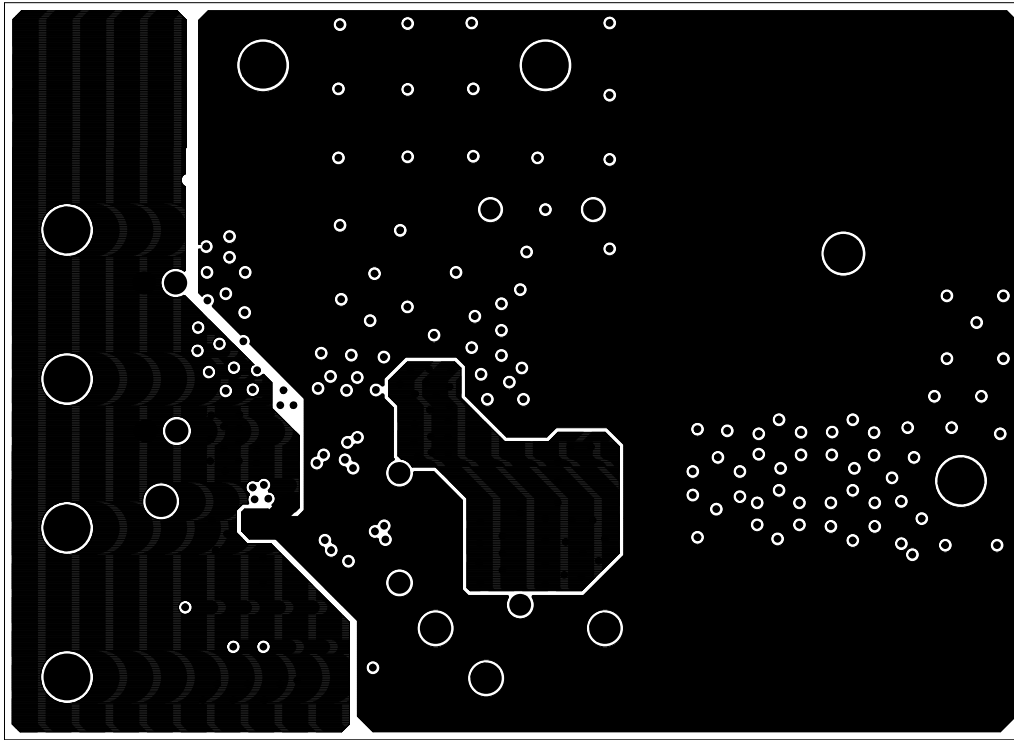

ISL6420AEVAL3Z - LAYER 2

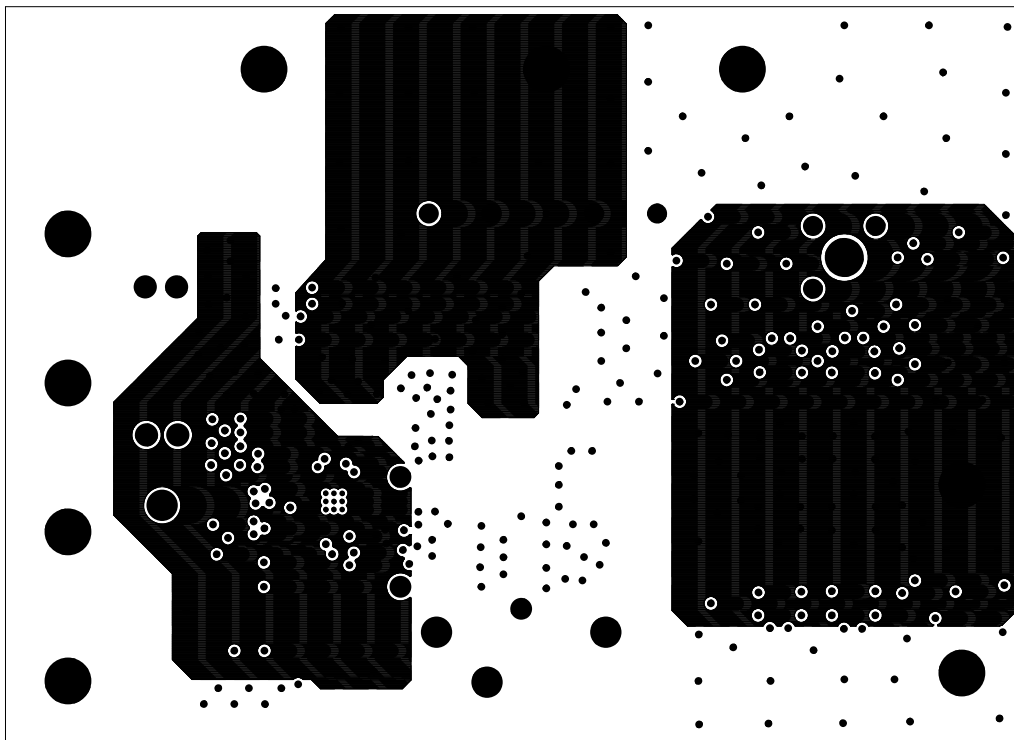

ISL6420AEVAL3Z - LAYER 3

ISL6420AEVAL3Z Printed Circuit Board Layers (Continued)

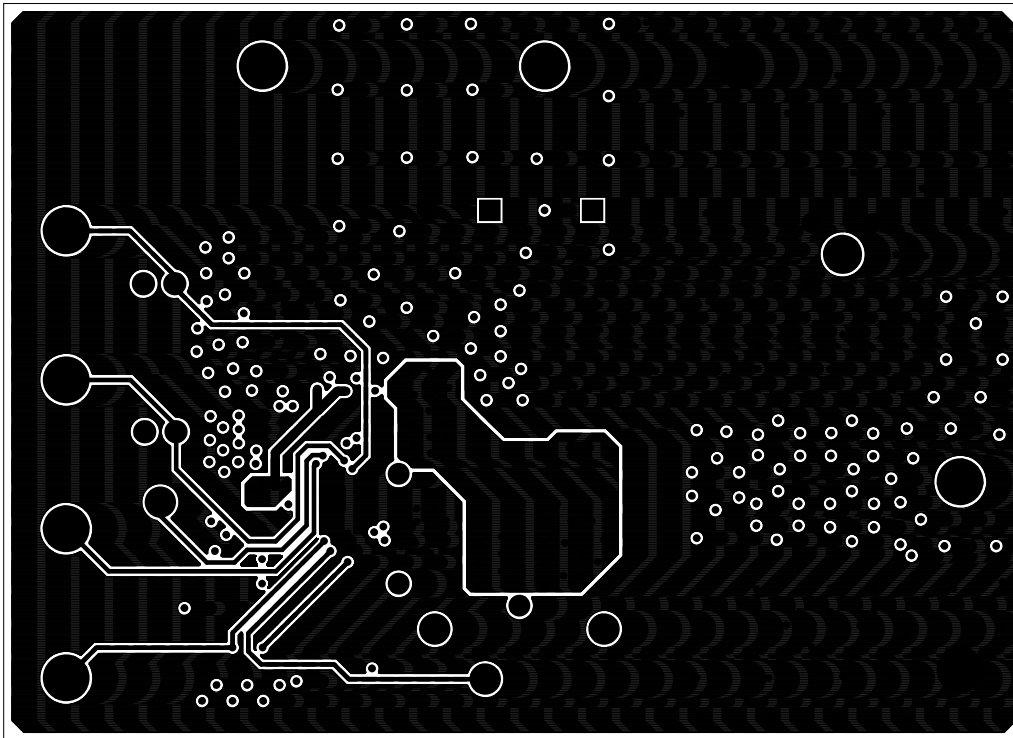

ISL6420AEVAL3Z - BOTTOM LAYER (SOLDER SIDE)

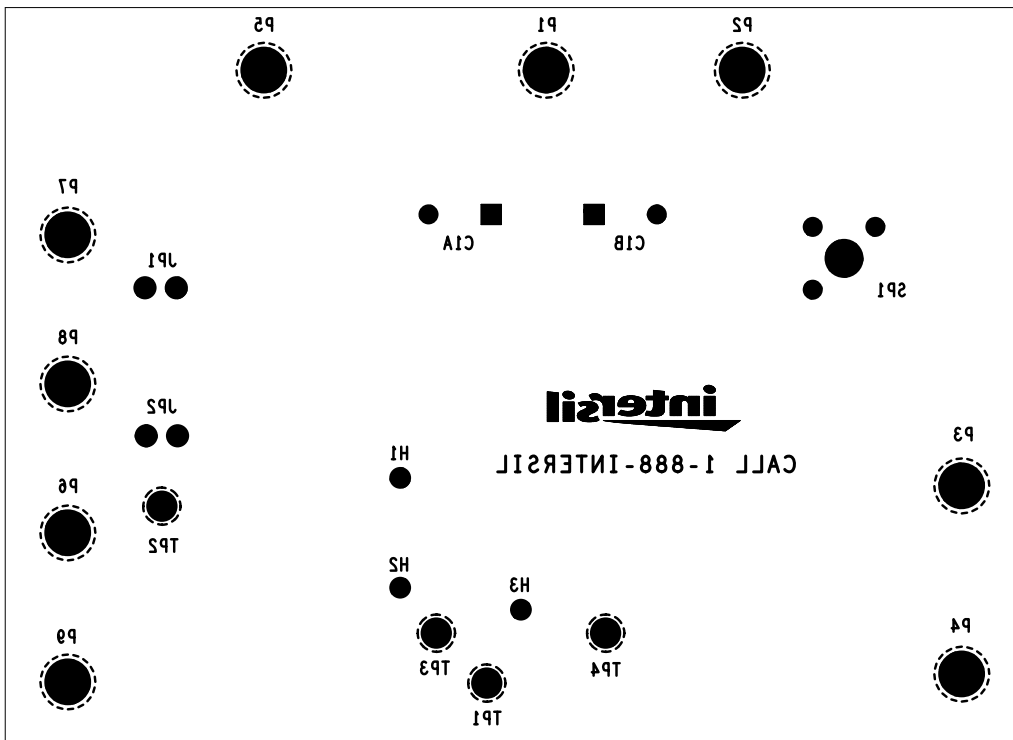

ISL6420AEVAL3Z - BOTTOM LAYER (SILKSCREEN)

Notice

1. Descriptions of circuits, software and other related information in this document are provided only to illustrate the operation of semiconductor products and application examples. You are fully responsible for the incorporation or any other use of the circuits, software, and information in the design of your product or system. Renesas Electronics disclaims any and all liability for any losses and damages incurred by you or third parties arising from the use of these circuits, software, or information.
2. Renesas Electronics hereby expressly disclaims any warranties against and liability for infringement or any other claims involving patents, copyrights, or other intellectual property rights of third parties, by or arising from the use of Renesas Electronics products or technical information described in this document, including but not limited to, the product data, drawings, charts, programs, algorithms, and application examples.
3. No license, express, implied or otherwise, is granted hereby under any patents, copyrights or other intellectual property rights of Renesas Electronics or others.
4. You shall not alter, modify, copy, or reverse engineer any Renesas Electronics product, whether in whole or in part. Renesas Electronics disclaims any and all liability for any losses or damages incurred by you or third parties arising from such alteration, modification, copying or reverse engineering.
5. Renesas Electronics products are classified according to the following two quality grades: "Standard" and "High Quality". The intended applications for each Renesas Electronics product depends on the product's quality grade, as indicated below.
"Standard": Computers; office equipment; communications equipment; test and measurement equipment; audio and visual equipment; home electronic appliances; machine tools; personal electronic equipment; industrial robots; etc.
"High Quality": Transportation equipment (automobiles, trains, ships, etc.); traffic control (traffic lights); large-scale communication equipment; key financial terminal systems; safety control equipment; etc.
Unless expressly designated as a high reliability product or a product for harsh environments in a Renesas Electronics data sheet or other Renesas Electronics document, Renesas Electronics products are not intended or authorized for use in products or systems that may pose a direct threat to human life or bodily injury (artificial life support devices or systems; surgical implantations; etc.), or may cause serious property damage (space system; undersea repeaters; nuclear power control systems; aircraft control systems; key plant systems; military equipment; etc.). Renesas Electronics disclaims any and all liability for any damages or losses incurred by you or any third parties arising from the use of any Renesas Electronics product that is inconsistent with any Renesas Electronics data sheet, user's manual or other Renesas Electronics document.
6. When using Renesas Electronics products, refer to the latest product information (data sheets, user's manuals, application notes, "General Notes for Handling and Using Semiconductor Devices" in the reliability handbook, etc.), and ensure that usage conditions are within the ranges specified by Renesas Electronics with respect to maximum ratings, operating power supply voltage range, heat dissipation characteristics, installation, etc. Renesas Electronics disclaims any and all liability for any malfunctions, failure or accident arising out of the use of Renesas Electronics products outside of such specified ranges.
7. Although Renesas Electronics endeavors to improve the quality and reliability of Renesas Electronics products, semiconductor products have specific characteristics, such as the occurrence of failure at a certain rate and malfunctions under certain use conditions. Unless designated as a high reliability product or a product for harsh environments in a Renesas Electronics data sheet or other Renesas Electronics document, Renesas Electronics products are not subject to radiation resistance design. You are responsible for implementing safety measures to guard against the possibility of bodily injury, injury or damage caused by fire, and/or danger to the public in the event of a failure or malfunction of Renesas Electronics products, such as safety design for hardware and software, including but not limited to redundancy, fire control and malfunction prevention, appropriate treatment for aging degradation or any other appropriate measures. Because the evaluation of microcomputer software alone is very difficult and impractical, you are responsible for evaluating the safety of the final products or systems manufactured by you.
8. Please contact a Renesas Electronics sales office for details as to environmental matters such as the environmental compatibility of each Renesas Electronics product. You are responsible for carefully and sufficiently investigating applicable laws and regulations that regulate the inclusion or use of controlled substances, including without limitation, the EU RoHS Directive, and using Renesas Electronics products in compliance with all these applicable laws and regulations. Renesas Electronics disclaims any and all liability for damages or losses occurring as a result of your noncompliance with applicable laws and regulations.
9. Renesas Electronics products and technologies shall not be used for or incorporated into any products or systems whose manufacture, use, or sale is prohibited under any applicable domestic or foreign laws or regulations. You shall comply with any applicable export control laws and regulations promulgated and administered by the governments of any countries asserting jurisdiction over the parties or transactions.
10. It is the responsibility of the buyer or distributor of Renesas Electronics products, or any other party who distributes, disposes of, or otherwise sells or transfers the product to a third party, to notify such third party in advance of the contents and conditions set forth in this document.
11. This document shall not be reprinted, reproduced or duplicated in any form, in whole or in part, without prior written consent of Renesas Electronics.
12. Please contact a Renesas Electronics sales office if you have any questions regarding the information contained in this document or Renesas Electronics products.
(Note 1) "Renesas Electronics" as used in this document means Renesas Electronics Corporation and also includes its directly or indirectly controlled subsidiaries.
(Note 2) "Renesas Electronics product(s)" means any product developed or manufactured by or for Renesas Electronics.

(Rev.4.0-1 November 2017)



SALES OFFICES

Renesas Electronics Corporation

<http://www.renesas.com>

Refer to "<http://www.renesas.com/>" for the latest and detailed information.

Renesas Electronics America Inc.
1001 Murphy Ranch Road, Milpitas, CA 95035, U.S.A.
Tel: +1-408-432-8888, Fax: +1-408-434-5351

Renesas Electronics Canada Limited
9251 Yonge Street, Suite 8309 Richmond Hill, Ontario Canada L4C 9T3
Tel: +1-905-237-2004

Renesas Electronics Europe Limited
Dukes Meadow, Millboard Road, Bourne End, Buckinghamshire, SL8 5FH, U.K.
Tel: +44-1628-651-700, Fax: +44-1628-651-804

Renesas Electronics Europe GmbH
Arcadiastrasse 10, 40472 Düsseldorf, Germany
Tel: +49-211-6503-0, Fax: +49-211-6503-1327

Renesas Electronics (China) Co., Ltd.
Room 1709 Quantum Plaza, No.27 ZhichunLu, Haidian District, Beijing, 100191 P. R. China
Tel: +86-10-8235-1155, Fax: +86-10-8235-7679

Renesas Electronics (Shanghai) Co., Ltd.
Unit 301, Tower A, Central Towers, 555 Langao Road, Putuo District, Shanghai, 200333 P. R. China
Tel: +86-21-2226-0888, Fax: +86-21-2226-0999

Renesas Electronics Hong Kong Limited
Unit 1601-1611, 16/F., Tower 2, Grand Century Place, 193 Prince Edward Road West, Mongkok, Kowloon, Hong Kong
Tel: +852-2265-6688, Fax: +852-2886-9022

Renesas Electronics Taiwan Co., Ltd.
13F, No. 363, Fu Shing North Road, Taipei 10543, Taiwan
Tel: +886-2-8175-9600, Fax: +886-2-8175-9670

Renesas Electronics Singapore Pte. Ltd.
80 Bendemeer Road, Unit #06-02 Hyflux Innovation Centre, Singapore 339949
Tel: +65-6213-0200, Fax: +65-6213-0300

Renesas Electronics Malaysia Sdn.Bhd.
Unit 1207, Block B, Menara Amcorp, Amcorp Trade Centre, No. 18, Jln Persiaran Barat, 46050 Petaling Jaya, Selangor Darul Ehsan, Malaysia
Tel: +60-3-7955-9390, Fax: +60-3-7955-9510

Renesas Electronics India Pvt. Ltd.
No.777C, 100 Feet Road, HAL 2nd Stage, Indiranagar, Bangalore 560 038, India
Tel: +91-80-67208700, Fax: +91-80-67208777

Renesas Electronics Korea Co., Ltd.
17F, KAMCO Yangjae Tower, 262, Gangnam-daero, Gangnam-gu, Seoul, 06265 Korea
Tel: +82-2-558-3737, Fax: +82-2-558-5338