

ISL71441MEV1Z

The ISL71441MEV1Z evaluation board evaluates the performance of the radiation tolerant [ISL71441M](#) 12V half-bridge GaN FET driver in an open-loop Buck configuration. The ISL71441MEV1Z evaluation board includes the GaN FET half-bridge driver, Renesas GaN FETs, and a Buck converter power stage inductor and output capacitors.

For more information about the ISL71441M, refer to the [ISL71441M Datasheet](#).

Features

- 4.75V to 13.2V VDD power supply range
- 300kHz to 1MHz PWM frequency range (external component limited)
- Bridge voltage (V_BUS) range: Up to 13.2V
- 5V max recommended buck output voltage (external component limited)
- Buck output load current up to 25A

Specifications

- Number of layers: 4
- PCB copper weight: 2oz
- Board revision: C

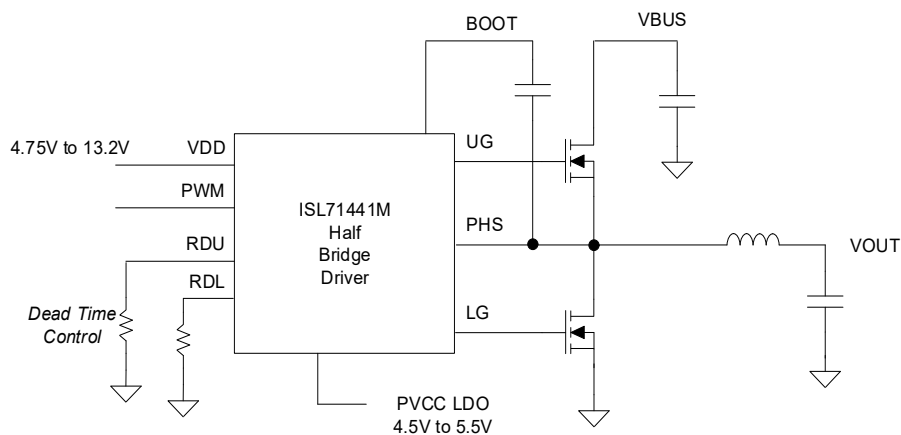

Figure 1. Application Diagram ISL71441M Driving GaN FET Half Bridge

Contents

1. Functional Description	3
1.1 Quick Start Instructions	3
1.2 Changing Power Inductor	3
1.3 Changing Power GaN FETs	3
1.4 Changing Programmable Dead Time	3
1.5 Changing the GaN FET Gate Drive Voltage	3
2. Board Design	4
2.1 Layout Guidelines	5
2.2 Schematic Diagram	6
2.3 Bill of Materials	7
2.4 Board Layout	9
3. Typical Performance Curves	12
4. Ordering Information	12
5. Revision History	12

1. Functional Description

1.1 Quick Start Instructions

1. Verify that the JP3 jumper is installed in the 2-3 position for EN = VDD
 - No other jumpers should be populated
2. Apply 4.75V to 13.2V from VDD to GND. Check for voltage on AVCC = 5.0V and PVCC = 4.5V. FLTb LED should be green.
3. Apply 5V to 13.2V from V_BUS to GND.
4. Apply a 0V to 5V, 500kHz signal with a duty cycle of $D = t_{on}/T_s$ to PWM input.
5. Measure voltage at V_OUT. It should be $D \times V_BUS$, where D is the duty cycle of the PWM signal. Renesas recommends keeping V_OUT below 5V.

1.2 Changing Power Inductor

The ISL71441MEV1Z is populated with a 0.22 μ H inductor on the L1 footprint targeted for 500kHz to 1MHz switching frequency. The inductor used is a Coilcraft XAL1010-022, which offers various inductor values in this XAL1010 family with the same footprint.

1.3 Changing Power GaN FETs

The ISL71441MEV1Z is configured with a Renesas ISL70020SEH 40V GaN FET for the high side and two ISL70020SEH GaN FET in parallel for the low side, intended for low-duty cycle operation. Renesas also offers the ISL70023SEH 100V GaN FET in the same die form. The user may change these GaN FETs depending on their $r_{DS(ON)}$ requirements.

1.4 Changing Programmable Dead Time

The ISL71441M driver offers 6.5ns-50ns programmable dead-time for the PWM inputs. Rising edge delays on UG and LG are programmable through a resistor on the RDU and RDL pins. See [Figure 11](#) and [Figure 12](#) to help choose the select resistor for the required dead time.

1.5 Changing the GaN FET Gate Drive Voltage

The gate drive voltage for the GaN FETs is set by the PVCC LDO internal to the ISL71441M. The PVCC LDO has a programmable range of 4.5V to 5.5V with the option to short the FB pin to PVCC to set PVCC = 4.5V using internal resistor dividers. If the user requires a different PVCC voltage, set the external feedback resistors using [Equation 1](#). For the GaN FETs, Renesas recommends keeping the PVCC gate drive voltage to 4.5V.

$$\text{(EQ. 1)} \quad PVCC = 1.2V \times \left(\frac{R_9}{R_{10}} + 1 \right)$$

2. Board Design

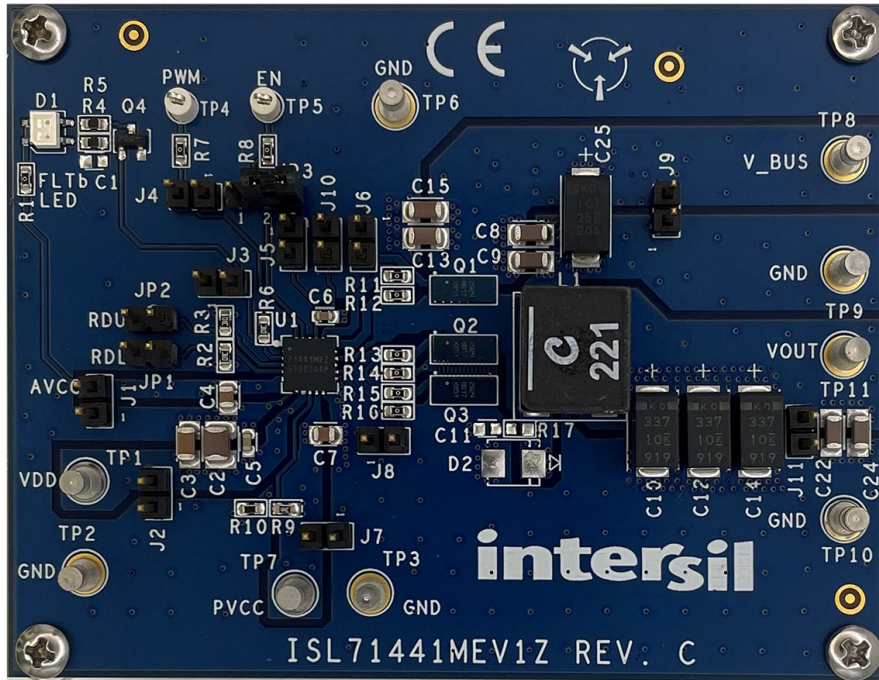

Figure 2. Evaluation Board (Top)

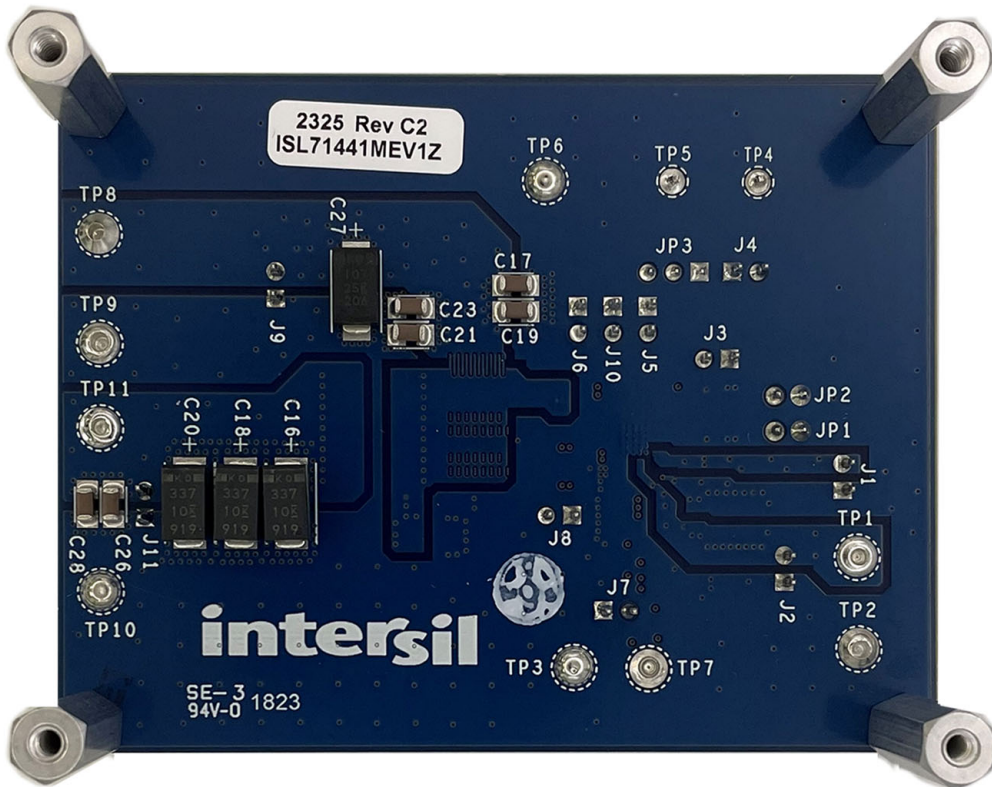

Figure 3. Evaluation Board (Bottom)

2.1 Layout Guidelines

PCB design files are available on the website to study or incorporate into your design.

- Use a multi-layer PCB with 2-ounce (70 μ m) copper outer layers to maximize PCB current capacitor and thermal handling.
- Place low ESR X7R grade or better ceramic capacitors for high-frequency decoupling as close to the package pins as possible. These include the capacitors between VDD-SGND, AVCC-SGND, PVCC-PGND, and BOOT-PHS.
- Place the RDU and RDL dead-time control resistors close to their respective pins and connect them to SGND through the PCB GND plane.
- Connect the PGND, SGND pins, and bottom EPAD of the package to the top layer GND plane of the PCB. To further improve thermal performance, place as many vias on the GND plane under the package EPAD to another internal GND plane to dissipate heat.
- Place the ISL71441M as close as possible to the half-bridge power GaN FET to minimize trace inductance and high current loop area between driver output and GaN FET gate.
- The PGND pin and low-side FET source should be connected commonly through the PCB GND plane. Route the PHS pin to the switch node of the half-bridge power stage with a short and wide trace to minimize inductance and loop area.
- For the low-side drive, the PVCC capacitor, PVCC and PGND pins, low-side driver gate outputs, low-side FET gate, and GND plane form a current loop during FET turn-on and turn-off. For the high-side drive, the bootstrap capacitor, BOOT and PHS pins, high-side driver gate outputs, high-side FET gate, and switch node form a current loop during FET turn-on and turn-off. Keep these loops short and wide, and avoid overlapping with other sensitive signals.
- Size the phase node of the half-bridge (high-side FET source and low-side FET drain) area to handle the current and thermal dissipation from the FETs and switching load. The phase node copper area usually ends up being a significantly large shape. In addition, the phase node is where high voltage and high dv/dt switching occurs. In general, there are two layout practices for handling the phase node. One recommendation is to remove any conductors (including ground) that overlap the phase node on the adjacent layer of the PCB. The other recommendation is to repeat the phase node shape on every layer of the PCB. Both methods minimize the capacitive coupling of noise into the GND plane and prevent any sensitive analog signals from being routed underneath the phase node and causing unintentional common mode noise.

2.2 Schematic Diagram

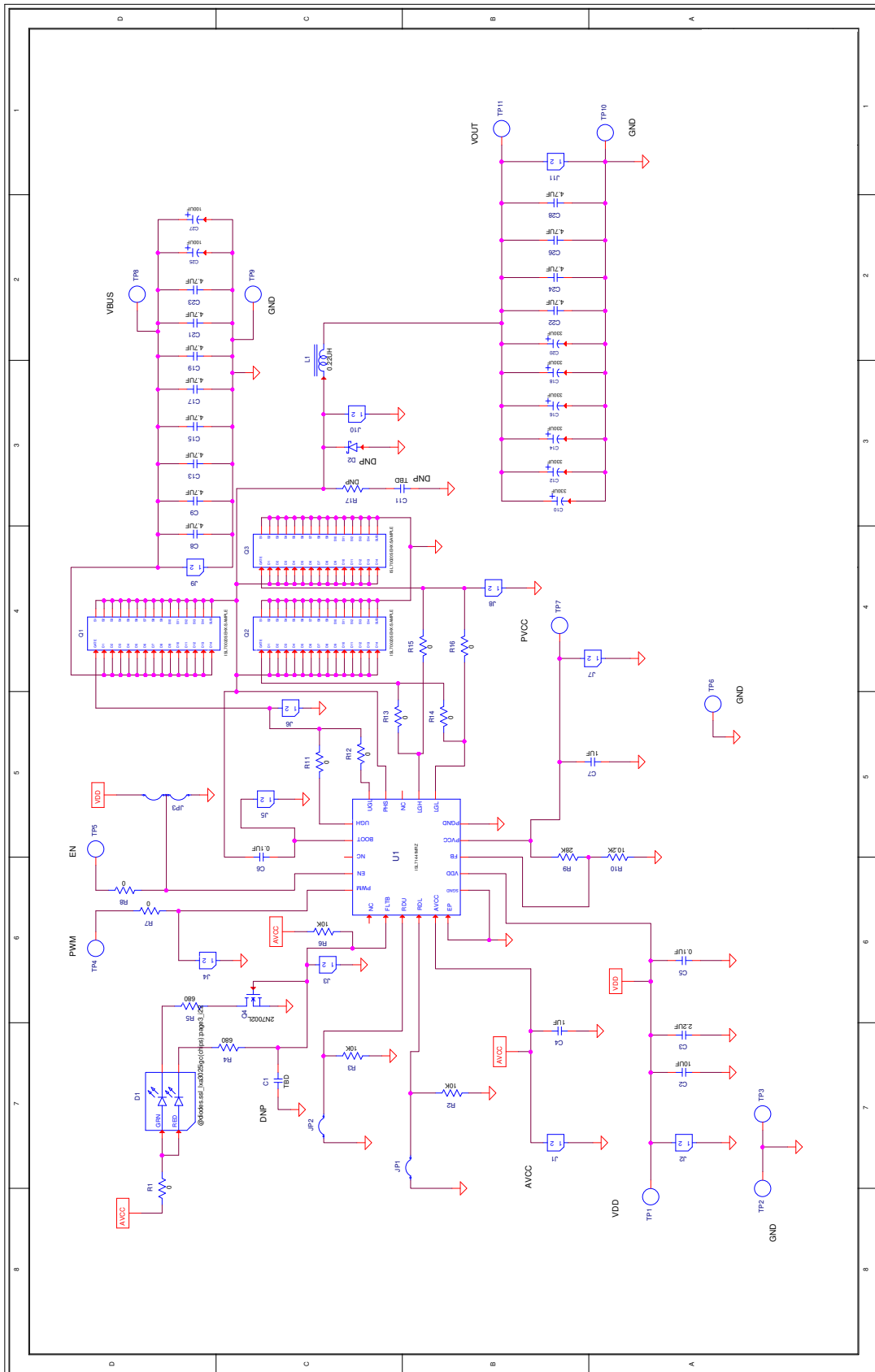

Figure 4. ISL71441MEV1Z Board Schematics

2.3 Bill of Materials

Qty	Reference Designator	Description	Manufacturer	Manufacturer Part
1		PWB-PCB, ISL71441MEV1Z, REVC, ROHS	Imagineering INC	ISL71441MEV1ZREVCPCB
2	C4, C7	CAP, SMD, 0805, 1.0 μ F, 25V, 10%, X7R, ROHS	TDK	C2012X7R1E105K125AB
12	C8, C9, C13, C15, C17, C19, C21, C22, C23, C24, C26, C28	CAP, SMD, 1206, 4.7 μ F, 25V, 10%, X7R, ROHS	TDK	C3216X7R1E475K
1	C2	CAP, SMD, 1210, 10 μ F, 25V, 10%, X7R, ROHS	TDK	C3225X7R1E106K
1	C3	CAP, SMD, 1206, 2.2 μ F, 50V, 10%, X7R, ROHS	Murata	GRM31CR71H225KA88L
1	C6	CAP, SMD, 0603, 0.1 μ F, 16V, 10%, X7R, ROHS	Murata	GCM188R71C104KA37D
1	C5	CAP, SMD, 0603, 0.1 μ F, 25V, 10%, X7R, ROHS	Yageo	CC0603KRX7R8BB104
0	C1, C11	CAP, SMD, 0603, DNP- PLACE HOLDER, ROHS		
2	C25, C27	CAP-TANT, SMD, 7.3x4.3mm, 100 μ F, 25V, 20%, 40m Ω at 100MHz, ROHS	Kemet	T521D107M025ATE040
6	C10, C12, C14, C16, C18, C20	CAP-TANT, SMD, 7.3x4.3x4, 330 μ F, 10V, 20%, 5m Ω , TIN, ROHS	Kemet	T530X337M010ATE005
1	L1	COIL-PWR INDUCT, AEC- Q200, SMD, 11.3x10mm, 0.22 μ H, 20%, 98.8A, ROHS	Coilcraft	XAL1010-221MEB
7	TP1, TP2, TP7, TP8, TP9, TP10, TP11	CONN-DBL TURRET, TH, 0.218x0.078 PCB MNT, TIN/BRASS, ROHS	Keystone	1502-1
2	TP3, TP6	CONN-DBL TURRET, TH, 0.218x0.109 PCB MNT, TIN/BRASS, ROHS	Keystone	1502-2
2	TP4, TP5	CONN-MINI TEST POINT, VERTICAL, WHITE, ROHS	Keystone	5002
1	JP3	CONN-HEADER, 1x3, BRKAWY 1x36, 2.54mm, ST	BERG/FCI	68000-236-1X3
2	JP1, JP2	CONN-HEADER, 1x2, RETENTIVE, 2.54mm, 0.230x0.120, ROHS"	BERG/FCI	69190-202HLF
11	J1-J11	CONN-HEADER, TH, 2x1, BRKAWY, 0.100inCENTER, 0.230x0.200in, ROHS	SAMTEC	TSW-102-08-F-S

Qty	Reference Designator	Description	Manufacturer	Manufacturer Part
1	D1	LED, SMD, 3×2.5mm, 4P, RED/GREEN, 12/20MCD, 2V	LUMEX	SSL-LXA3025IGC-TR
3	Q1, Q2, Q3	IC-SAMPLE DIE, RAD HARD, 40V GAN FET, ROHS	Renesas Electronics America	ISL70020SEHX/SAMPLE
1	U1	IC-GAN FET DRIVER, HALF-BRIDGE, 20P, QFN, ROHS	Renesas Electronics America	ISL71441MRZ
1	Q4	TRANSISTOR-MOS, N-Channel, SMD, SOT23, 60V, 115mA, ROHS	On Semiconductor	2N7002LT1G
2	R4, R5	RES-AEC-Q200, SMD, 0603, 680Ω, 1/10W, 1%, TF, ROHS	Vishay/Dale	CRCW0603680RFKEA
0	R17	RESISTOR, SMD, 0603, 0.1%, MF, DNP-PLACE HOLDER		
9	R1, R7, R8, R11, R12, R13, R14, R15, R16	RES, SMD, 0603, 0Ω, 1/10W, TF, ROHS	Venkel	CR0603-10W-000T
3	R2, R3, R6	RES, SMD, 0603, 10K, 1/10W, 1%, TF, ROHS	Venkel	CR0603-10W-1002FT
1	R10	RES, SMD, 0603, 10.2K, 1/10W, 1%, TF, ROHS	Yageo	9C06031A1022FKHFT
1	R9	RES, SMD, 0603, 28K, 1/10W, 1%, TF, ROHS	Venkel	CR0603-10W-2802FT
4	Four corners top PCB	SCREW, 4-40×1/4in, PHILLIPS, PANHEAD, STAINLESS, ROHS	Building Fasteners	PMSSS 440 0025 PH
4	Four corners bottom PCB	STANDOFF, 4-40×3/4in, F/F, HEX, ALUMINUM, 0.25 OD, ROHS	Keystone	2204
0	D2 (B120B-13-F)	DO NOT POPULATE OR PURCHASE		

2.4 Board Layout

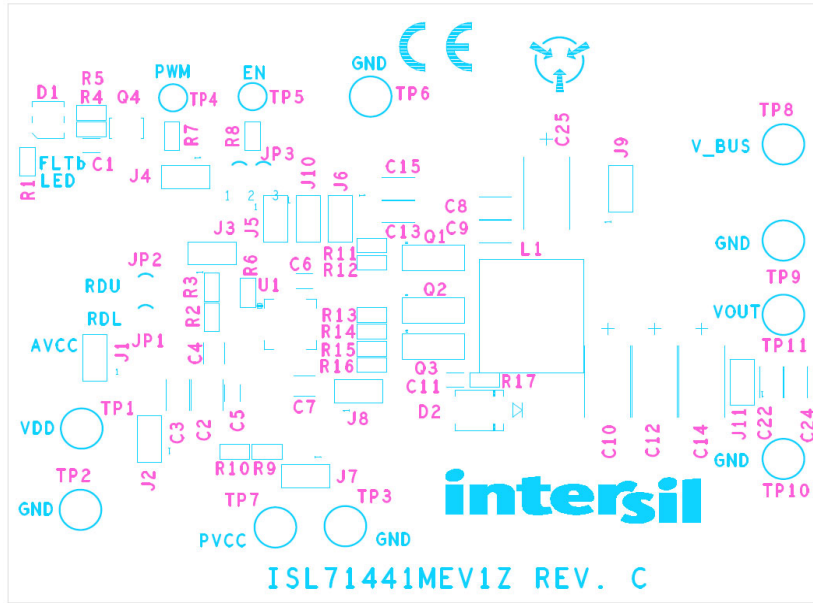

Figure 5. ISL71441MEV1Z Top Silkscreen Layer

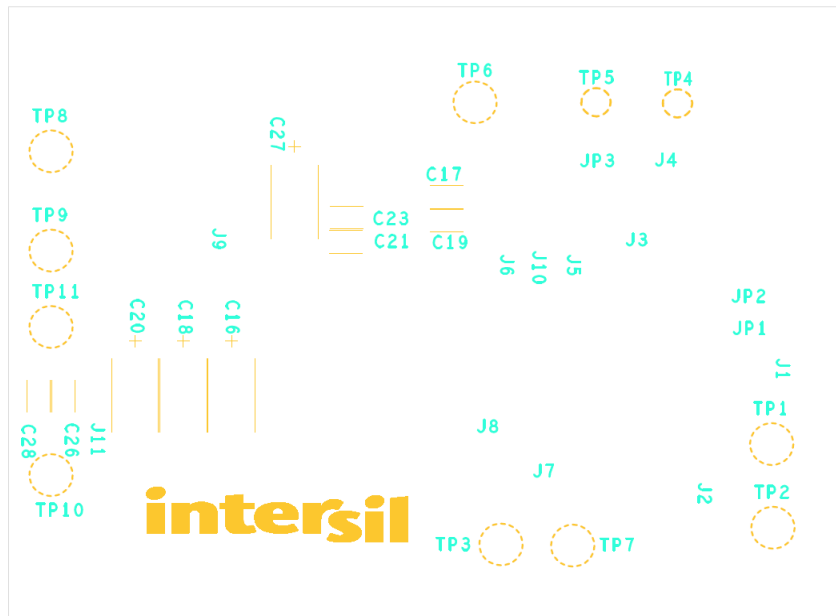

Figure 6. ISL71441MEV1Z Bottom Silkscreen Layer

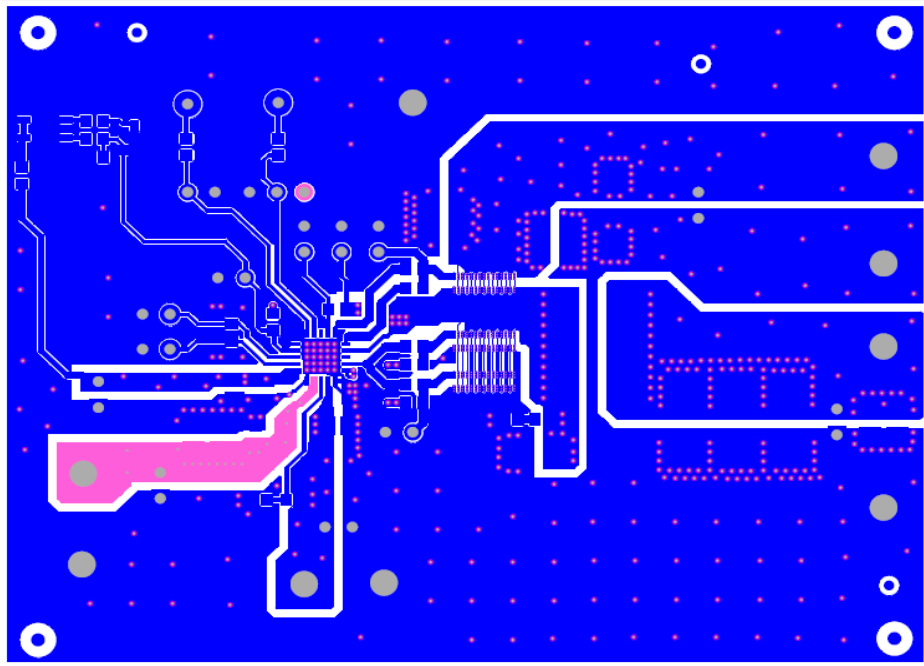

Figure 7. ISL71441MEV1Z Layer 1

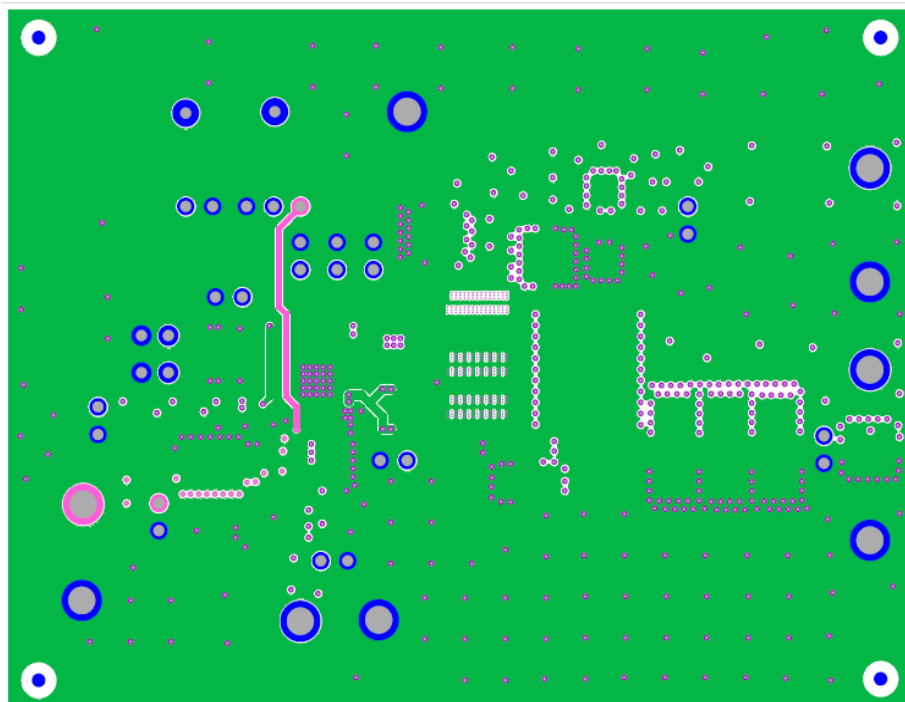

Figure 8. ISL71441MEV1Z Layer 2

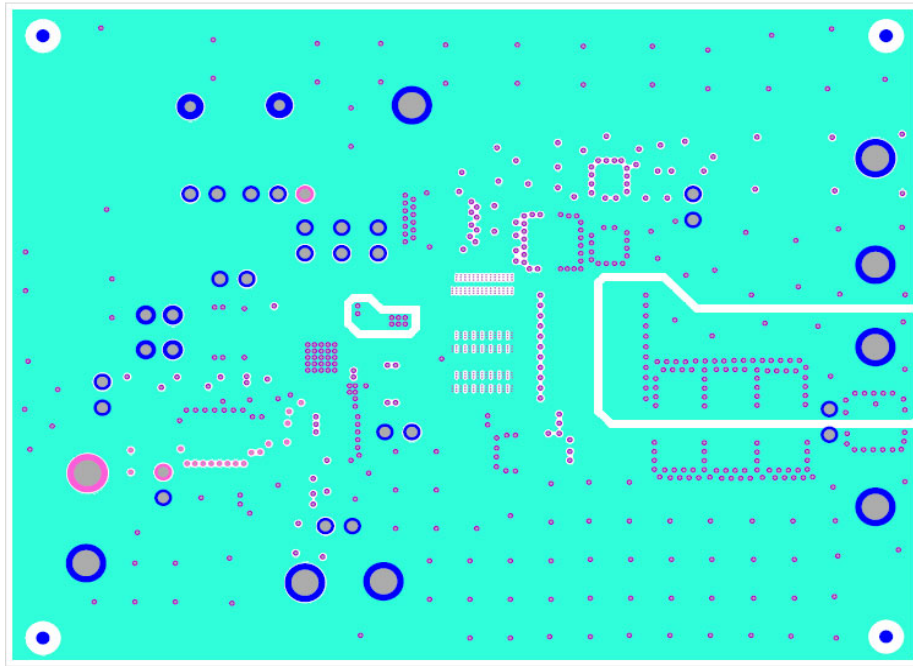

Figure 9. ISL71441MEV1Z Layer 3

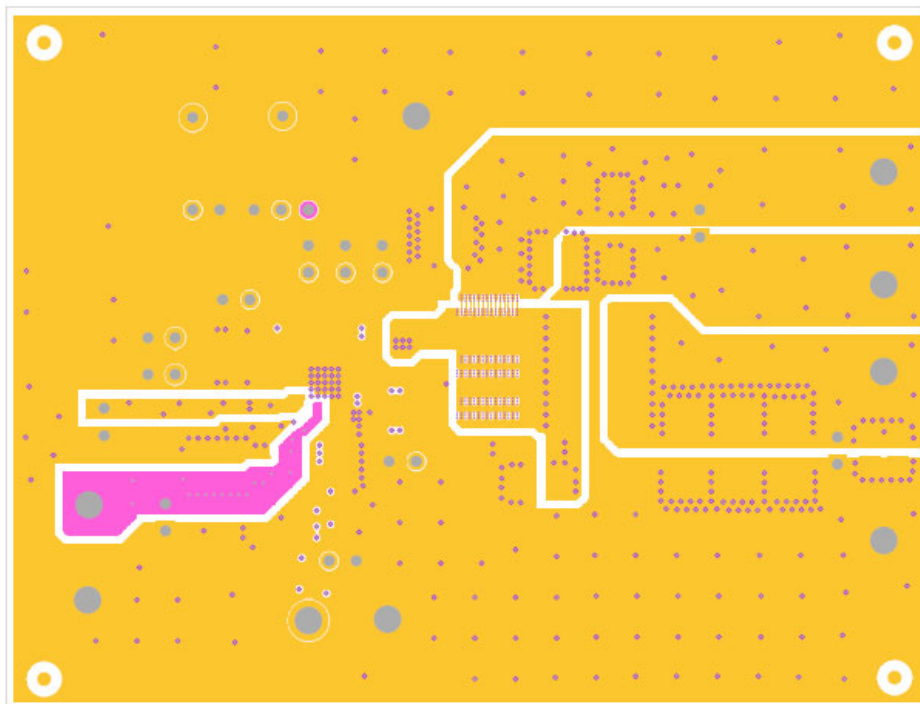

Figure 10. ISL71441MEV1Z Layer 4

3. Typical Performance Curves

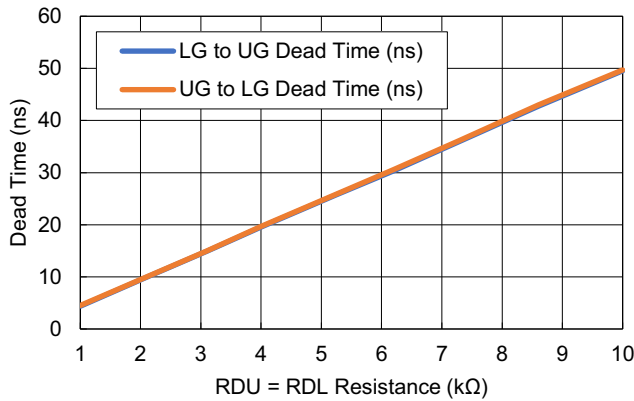

Figure 11. Dead Time vs Resistance; 1kΩ-10kΩ

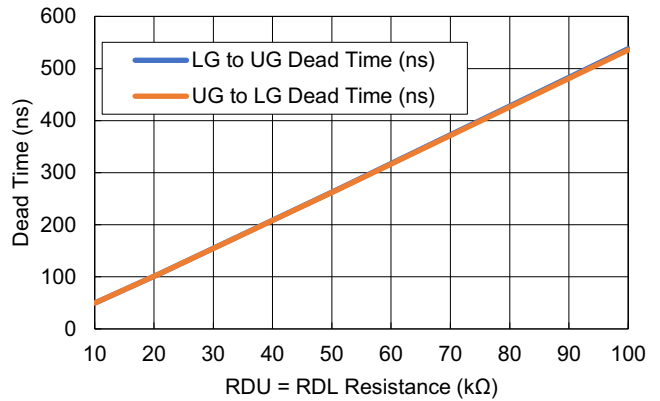

Figure 12. Dead Time vs Resistance; 10kΩ-100kΩ

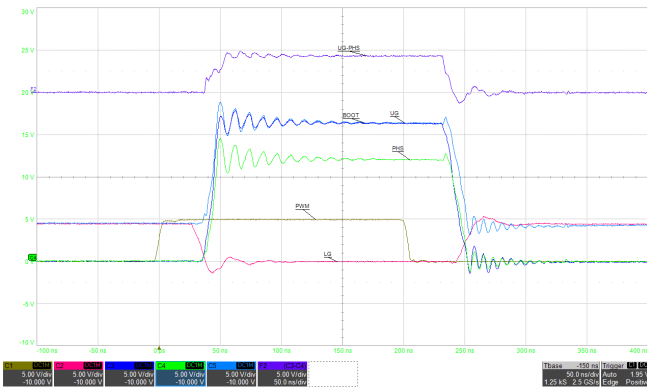

Figure 13. Half Bridge Switching Waveforms;
I_LOAD = 0A

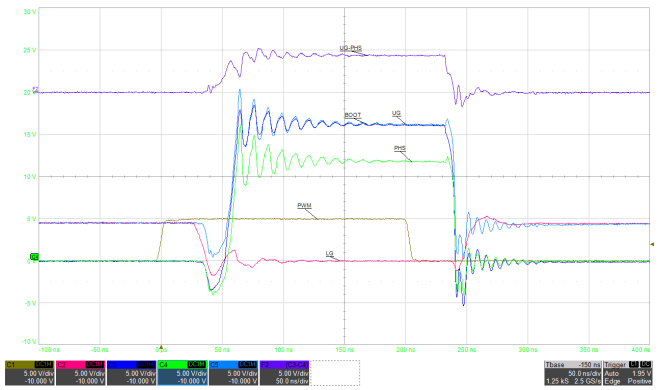

Figure 14. Half Bridge Switching Waveforms;
I_LOAD = 20A

4. Ordering Information

Part Number	Description
ISL71441MEV1Z	ISL71441M 12V GaN Half Bridge Driver Evaluation Board

5. Revision History

Revision	Date	Description
1.00	Jul 3, 2023	Initial release

IMPORTANT NOTICE AND DISCLAIMER

RENESAS ELECTRONICS CORPORATION AND ITS SUBSIDIARIES (“RENESAS”) PROVIDES TECHNICAL SPECIFICATIONS AND RELIABILITY DATA (INCLUDING DATASHEETS), DESIGN RESOURCES (INCLUDING REFERENCE DESIGNS), APPLICATION OR OTHER DESIGN ADVICE, WEB TOOLS, SAFETY INFORMATION, AND OTHER RESOURCES “AS IS” AND WITH ALL FAULTS, AND DISCLAIMS ALL WARRANTIES, EXPRESS OR IMPLIED, INCLUDING, WITHOUT LIMITATION, ANY IMPLIED WARRANTIES OF MERCHANTABILITY, FITNESS FOR A PARTICULAR PURPOSE, OR NON-INFRINGEMENT OF THIRD PARTY INTELLECTUAL PROPERTY RIGHTS.

These resources are intended for developers skilled in the art designing with Renesas products. You are solely responsible for (1) selecting the appropriate products for your application, (2) designing, validating, and testing your application, and (3) ensuring your application meets applicable standards, and any other safety, security, or other requirements. These resources are subject to change without notice. Renesas grants you permission to use these resources only for development of an application that uses Renesas products. Other reproduction or use of these resources is strictly prohibited. No license is granted to any other Renesas intellectual property or to any third party intellectual property. Renesas disclaims responsibility for, and you will fully indemnify Renesas and its representatives against, any claims, damages, costs, losses, or liabilities arising out of your use of these resources. Renesas' products are provided only subject to Renesas' Terms and Conditions of Sale or other applicable terms agreed to in writing. No use of any Renesas resources expands or otherwise alters any applicable warranties or warranty disclaimers for these products.

(Disclaimer Rev.1.0 Mar 2020)

Corporate Headquarters

TOYOSU FORESIA, 3-2-24 Toyosu,
Koto-ku, Tokyo 135-0061, Japan
www.renesas.com

Contact Information

For further information on a product, technology, the most up-to-date version of a document, or your nearest sales office, please visit:
www.renesas.com/contact/

Trademarks

Renesas and the Renesas logo are trademarks of Renesas Electronics Corporation. All trademarks and registered trademarks are the property of their respective owners.