

## ISL73141SEHF7EV1Z, ISL73141SEHFNEV1Z

The ISL73141SEHF7EV1Z and ISL73141SEHFNEV1Z boards evaluate the operation of the Renesas ISL73141SEH radiation hardened 14-Bit 1000kps/750kps SAR ADC. The evaluation boards are intended to be used with the RHADC-FMCEV1Z data capture board.

The ISL73141SEH device on the evaluation board supports operation of the ISL73141SEH with AVCC set to either 5V or 3.3V. DVCC can be set to 2.5V or 3.3V, but the default setting is 2.5V. The reference voltage to the ADC can be set to 3.0V or 4.096V. Setting the reference voltage to 4.096V is only valid for the 5V version of the ISL73141SEH. The I/O voltage of the CPLD can be set to 2.5V or 3.3V operation as well, but should be matched to the DVCC setting. The supply voltage for the CPLD is set to 1.8V. The supply voltages to the analog input amplifier circuit is set to +7.5/-4.5V. These voltages are all derived from the  $\pm 10V$  supply inputs to the board.

### Specifications

- $\pm 10V$  power supply inputs
- VITA 57.1 FMC connector for interoperability
- Supports  $-55^{\circ}C$  to  $+125^{\circ}C$  operation
- Supporting components support  $-40^{\circ}C$  to  $+85^{\circ}C$  operation
- Jumper selectable for +5V or +3.3V AVCC operation
- Jumper selectable for +4.096V or +3V VVREF operation

### Features

These evaluation boards evaluate the common performance metrics of the ISL73141SEH listed in the datasheet for the device. These parameters include:

- Signal-to-Noise Ratio (SNR)
- Signal-to-Noise-and-Distortion Ratio (SINAD)
- Effective Number of Bits (ENOB)
- Total Harmonic Distortion (THD)
- Spurious Free Dynamic Range (SFDR)
- Input voltage range (Analog input)
- REF input voltage range (VREF input)

### Required Equipment

To properly operate the ISL73141SEH board and the RHADC-FMCEV1Z board the following equipment is required:

- Low phase noise analog signal source (such as the Rohde-Schwarz SMA100A or SMA100B)
- Low phase noise clock source (such as the clock synthesis on the Rohde-Schwarz SMA100A or SMA100B)
- $\pm 10V$  DC power supply
- 5V, 3.6A switching power supply (such as the CUI ETSA050360UDC-P5P-SZ supplied with the RHADC-FMCEV1Z data capture board)
- USB 2.0 cable and port on PC
- PC running Windows 10 or greater
- ISL73141SEHF7EV1Z or ISL73141SEHFNEV1Z ADC evaluation board
- [RHADC-FMCEV1Z](#) data capture board
- Renesas [iRADAnalyzer](#) software

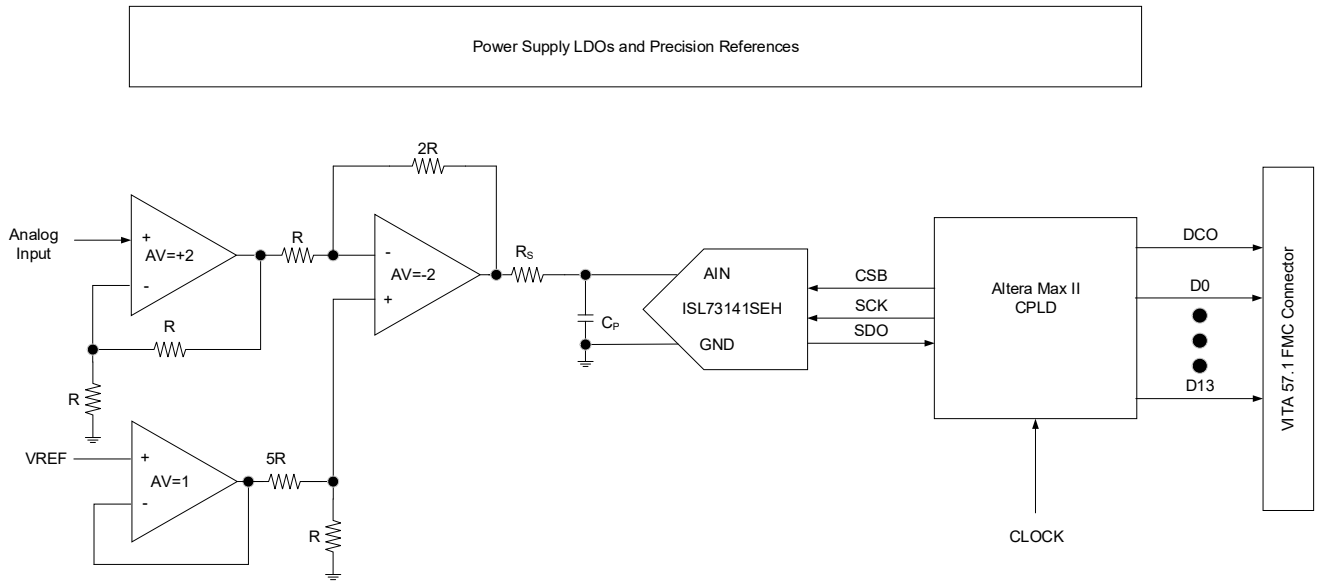

Figure 1. ISL73141SEHF7EV1Z and ISL73141SEHFNEV1Z Block Diagram

## Contents

|  |           |
|--|-----------|
| <b>1. Functional Description</b>                           | <b>3</b>  |
| 1.1 Operating Range  | 4         |
| 1.2 Connecting the Evaluation and Data Capture Boards      | 4         |
| 1.2.1 iRADAnalyzer RHADC-FMCEV1Z Board Initialization      | 6         |
| 1.2.2 iRADAnalyzer Data Capture - FFT                      | 6         |
| 1.2.3 iRADAnalyzer Data Capture - Time Domain              | 7         |
| 1.2.4 iRADAnalyzer - Save Data Files                       | 8         |
| <b>2. PCB Layout Guidelines</b>                            | <b>9</b>  |
| 2.1 ISL73141SEHF7EV1Z, ISL73141SEHFNEV1Z Evaluation Boards | 9         |
| 2.2 Board Schematics                                       | 11        |
| 2.3 Bill of Materials                                      | 17        |
| 2.4 Evaluation Board Layout                                | 20        |
| <b>3. Ordering Information</b>                             | <b>25</b> |
| <b>4. Revision History</b>                                 | <b>25</b> |

# 1. Functional Description

The digitized data from the ADC is passed to the RHADC-FMCEV1Z using the VITA 57.1 FMC mezzanine connector. The iRADAnalyzer application software controls the capture of data and provides FFT performance data of the ADC. [Figure 5](#) shows the GUI interface of the application software.

[Figure 2](#) shows the location and position of the jumpers on the ISL73141SEHFNEV1Z board (AVCC = 3.3V) and [Figure 3](#) shows the jumper location and position for the ISL73141SEHF7EV1Z (AVCC = 5.0V). The default positions of the jumpers select the use of the on-board LDOs to drive the various power supply domains.

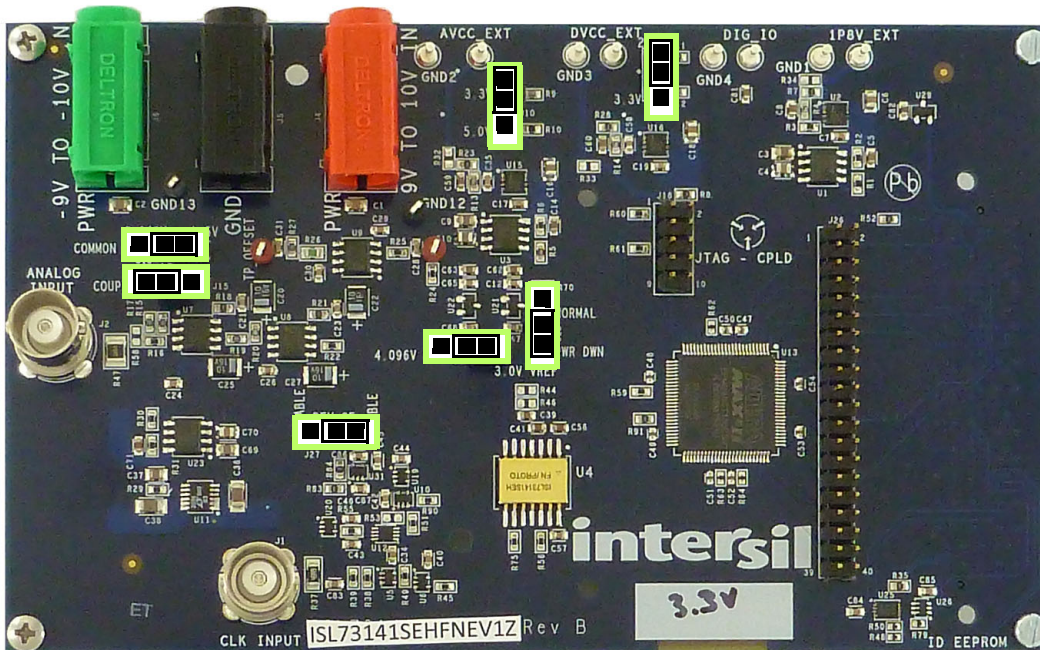

Figure 2. ISL73141SEHFNEV1Z Evaluation Board Jumper Location

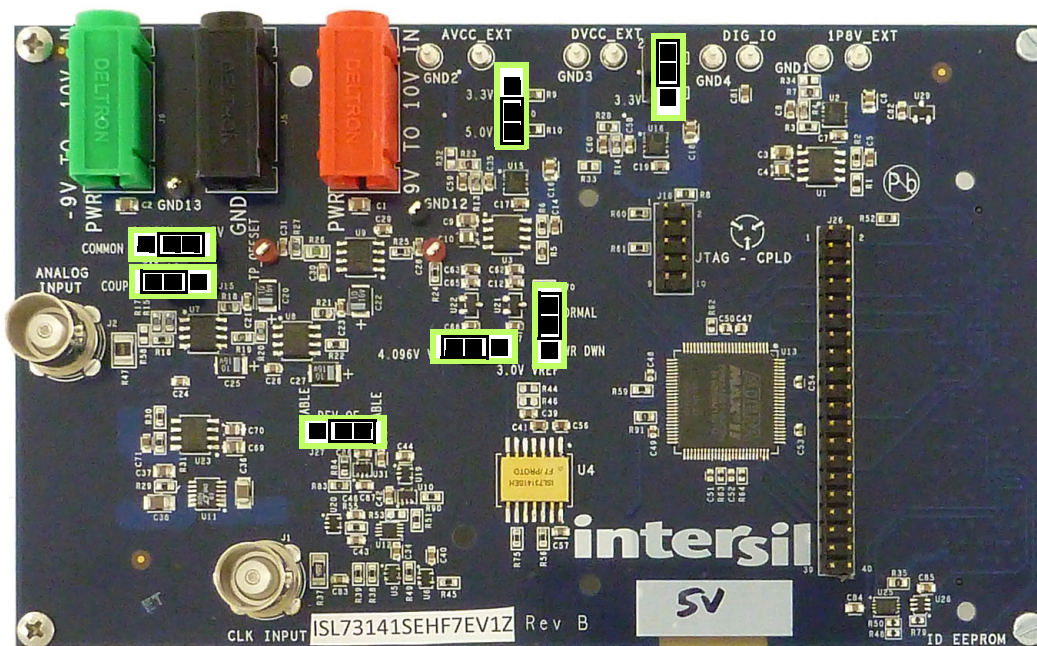

Figure 3. ISL73141SEHF7EV1Z Evaluation Board Jumper Location

Figure 4 provides a view of the ISL73141SEH evaluation board along and the RHADC-FMCEV1Z data capture board with the required external connections. Renesas power products ISL80410 and ISL80505 provide the voltages for the various supply domains while the ISL60002 and X60003 provide the reference voltages for the ADC on the ISL73141SEH evaluation board. An Altera MAXII CPLD is used to capture the serial data from the ADC and parallelize the data to present it at the 40-pin parallel connector and the VITA 57.1 FMC mezzanine connector.

Power for the system is provided by  $\pm 10V$  external power supplies on the three banana jack terminals J4, J5, and J6. The red banana jack, J4, is to be connected to +10V, the black banana jack, J5, is to be connected to ground, and the green banana jack, J6, is to be connected to -10V.

The analog input to the ADC should be provide to the BNC connector (J2). This input is terminated to ground using a 50 $\Omega$  resistor. This input should be a clean, low phase noise input source. A typical input frequency of 105kHz can be used with an amplitude of approximately 1.0V<sub>P-P</sub> which sets the input level to the ADC at -1dBFS. Renesas recommends using a bandpass filter with sufficient stop-band attenuation to limit the harmonic distortion from the analog input source. A Q70 series bandpass filter of 30% bandwidth of less from TTE or equivalent is recommended.

The input clock should be provided to the BNC connector (J1). This is the master clock reference for the ISL73141SEH evaluation board. For 1000ksps sample rate operation of the ISL73141SEH ADC, an input clock rate of 100MHz is required. To achieve a sample rate of 750ksps an input clock of 75MHz is required. To achieve the desired sample rate the input clock should be 100x the desired sample rate. For example, for a 500ksps operation, the input clock should be 50MHz. While the ADC supports sample rates near DC (extremely sparse sampling over time), the evaluation board hardware does not support sample rates below 300ksps.

The Altera Max II CPLD on the ISL73141SEH evaluation board takes the serial ADC data and parallelizes the data. The data output from the CPLD to the FMC connector is delivered to the Virtex 5 FPGA on the RHADC-FMCEV1Z data capture board. It is collected on the data capture board and passed using a USB to the PC to the iRADAnalyzer software application for processing.

The evaluation board can operate in standalone mode where the digitized data from the ADC can be accessed from the 40-pin parallel port connector. In this case, you are required to process the data from the ADC.

### 1.1 Operating Range

The ISL73141SEH device on the evaluation board supports operation from -55°C to +125°C. However, many of the components used on the evaluation board support a commercial temperature range of -40°C to +85°C. This evaluation board as a whole is intended to operate under ambient temperature conditions at 25°C for evaluation purposes. The ISL73141SEH device is heated or cooled across its operating temperature from -55°C to +125°C if an appropriate device (such as a Thermostream or similar) sets the temperature of the device itself.

### 1.2 Connecting the Evaluation and Data Capture Boards

1. Connect the supplied CUI 5V switching power supply to the RHADC-FMCEV1Z then connect a USB cable between the PC and the RHADC-FMCEV1Z. The board should be listed in Device Manager on the PC as Renesas RHADC-FMCEV1Z under Universal Serial Bus Controllers as shown in Figure 5.
2. Connect the ISL73141SEH ADC evaluation board to the RHADC-FMCEV1Z data capture board. There are four standoff guides on the RHADC-FMCEV1Z that fit into alignment holes on the ISL73141SEH evaluation board that help to align the FMC connectors of the two boards. Carefully press the ISL73141SEH evaluation board into place on the RHADCFMCEV1Z board.
3. Make sure the jumpers on the ADC evaluation board are in place as shown in Figure 2 or Figure 3.
4. Supply  $\pm 10V$  and ground to the banana jacks on the ADC evaluation board.
5. Provide a clean, low phase noise 100MHz input clock to the CLK INPUT connector (J1) on the ADC evaluation board. This provides the reference clock to the board, which sets the Convert Start Bar (CSB) signal to the ADC. The sample rate of the ADC is equal to the frequency of this input clock divided by 100.

- Provide a clean, low phase noise 105.3kHz analog input tone to the ANALOG INPUT connector (J2) on the ADC evaluation board through a bandpass filter such as the Q70 series 30% bandwidth TTE bandpass filter.

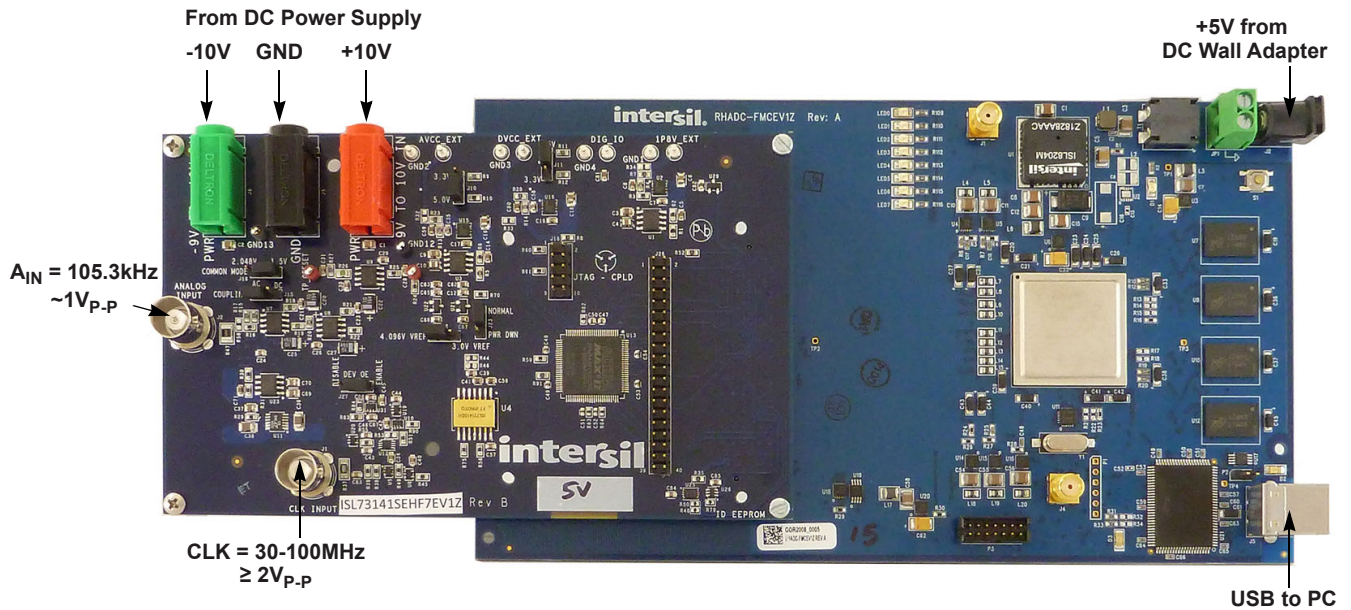

Figure 4. ISL73141SEHF7EV1Z/RHADC-FMCEV1Z Connection Diagram

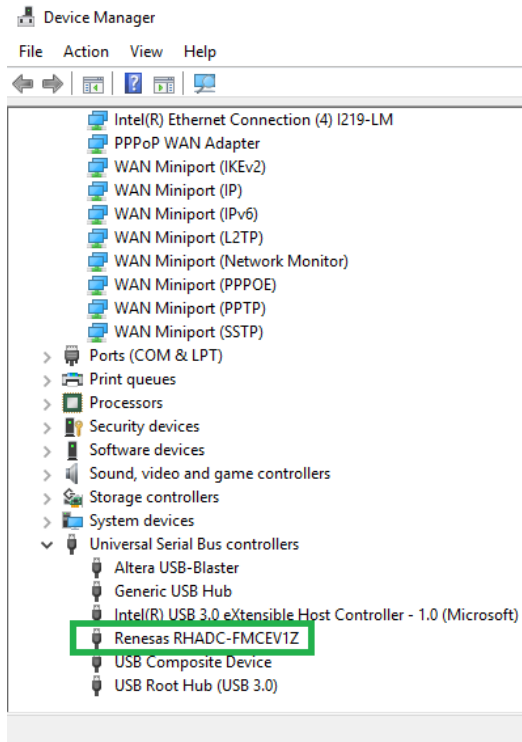

Figure 5. USB Device Driver in Device Manager

### 1.2.1 iRADAnalyzer RHADC-FMCEV1Z Board Initialization

When the ISL73141SEH boards and RHADC-FMCEV1Z boards have been connected and setup properly, open iRADAnalyzer on the PC by clicking **Start**→**Renesas iRADAnalyzer**→**iRADAnalyzer**. When the board is detected and configured by the iRADAnalyzer software application, it should indicate **Board Initialized** in the status window of the GUI as shown in [Figure 6](#).

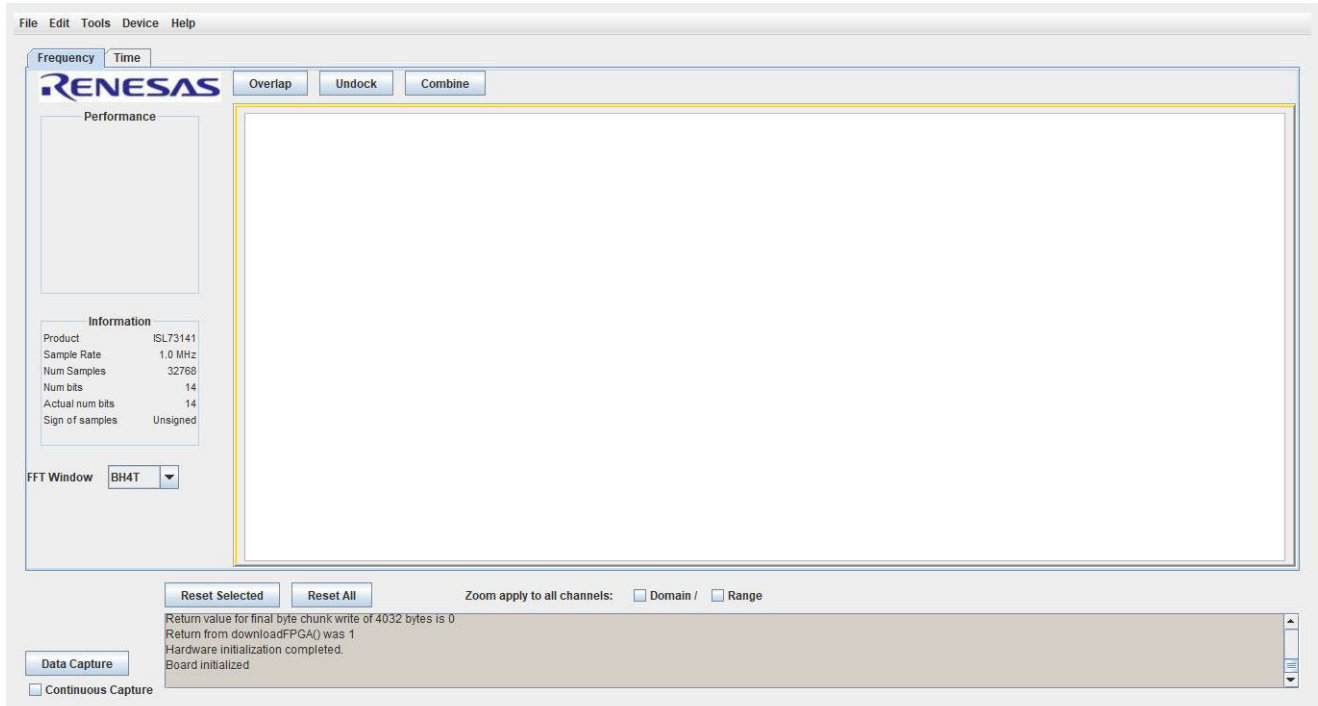

Figure 6. iRADAnalyzer Board Initialization (New Image)

### 1.2.2 iRADAnalyzer Data Capture - FFT

To begin the data capture from the ADC evaluation board click on the **Data Capture** button in the iRADAnalyzer software application. The software captures the data and provides an FFT of the results as shown in [Figure 7](#).

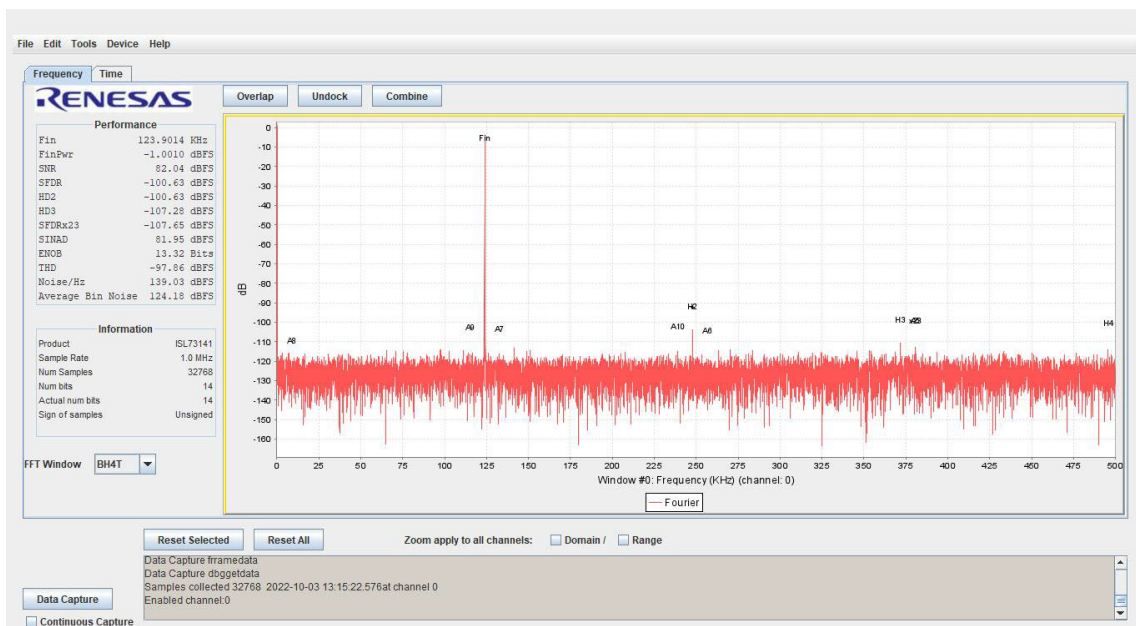

Figure 7. iRADAnalyzer FFT Plot (New Image)

### 1.2.3 iRADAnalyzer Data Capture - Time Domain

The time domain plot of the captured data can also be viewed. To do so click on the Time tab in the iRADAnalyzer GUI. This plots the entire data capture in time domain so Renesas recommends using the mouse to click and drag a zoom box in the time domain plot to be able to see the waveform as shown in Figure 9. *Note:* When using the zoom feature in the time domain plot, the frequency domain (FFT) plot is also zoomed. To restore the view to see the entire data capture click on the **Reset Zoom** button in the GUI. The **Time domain** tab (shown in Figure 9) offers an additional view called Bit Plot, which shows the individual bits plotted over time.

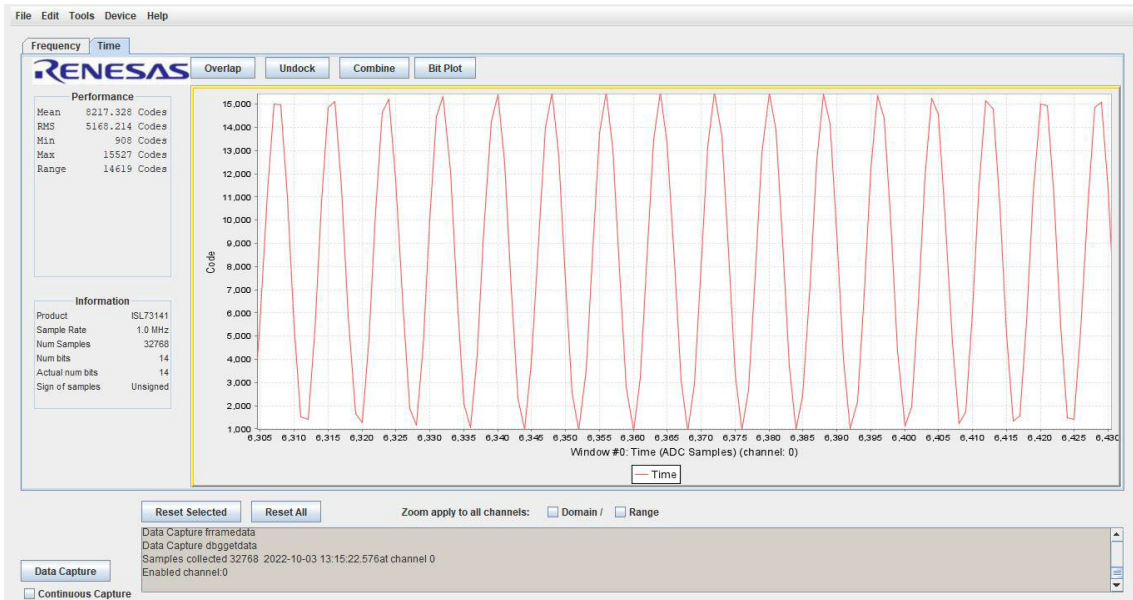

Figure 8. iRADAnalyzer Time Domain Plot (New Image)

To activate the Bit Plot, first select a channel to highlight in yellow. It brings up a separate window as shown in Figure 9. This plot can be zoomed and reset similar to the frequency and time domain plots. Renesas recommends zooming as shown in the figure so that the bits are more easily visible. The individual bits can be separated into separate plots if required by using the **Split** button. When the plots are split, a **Consolidate** button appears and can be used to recombine the bits into the same plot again.

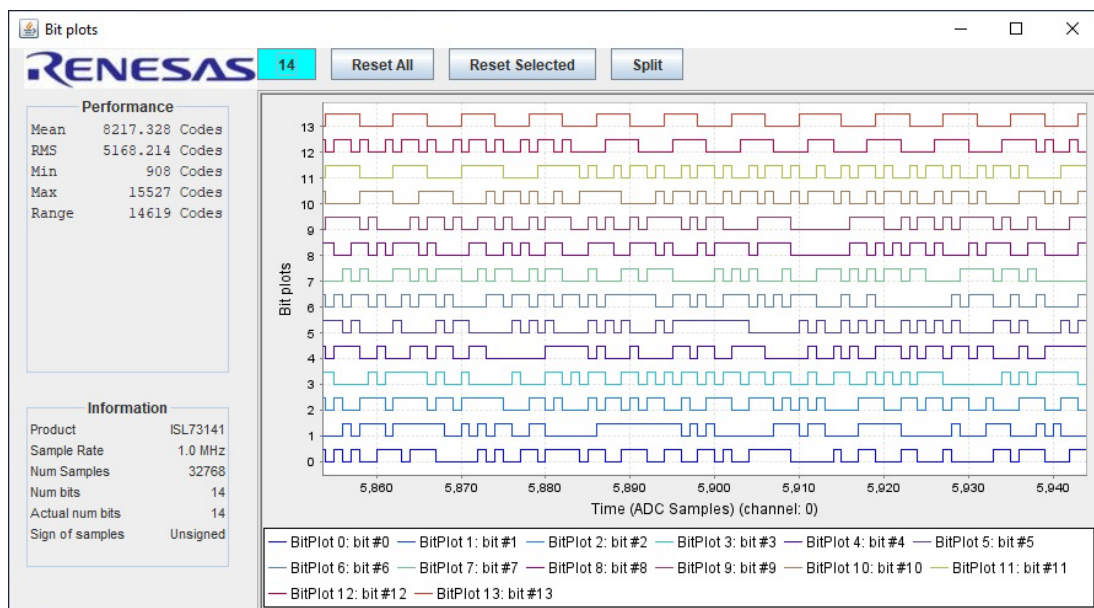

Figure 9. iRADAnalyzer Time Domain Bit Plot

### 1.2.4 iRADAnalyzer - Save Data Files

When the required data is collected, the iRADAnalyzer GUI can save the raw decimal data or the FFT data to a file. To save the raw decimal data to a file select **File**→**Save Data File**→**Save Time Domain**. To save the FFT data to a file select **File**→**Save Data File**→**Save Fourier Domain**. The menu options are shown in [Figure 10](#).

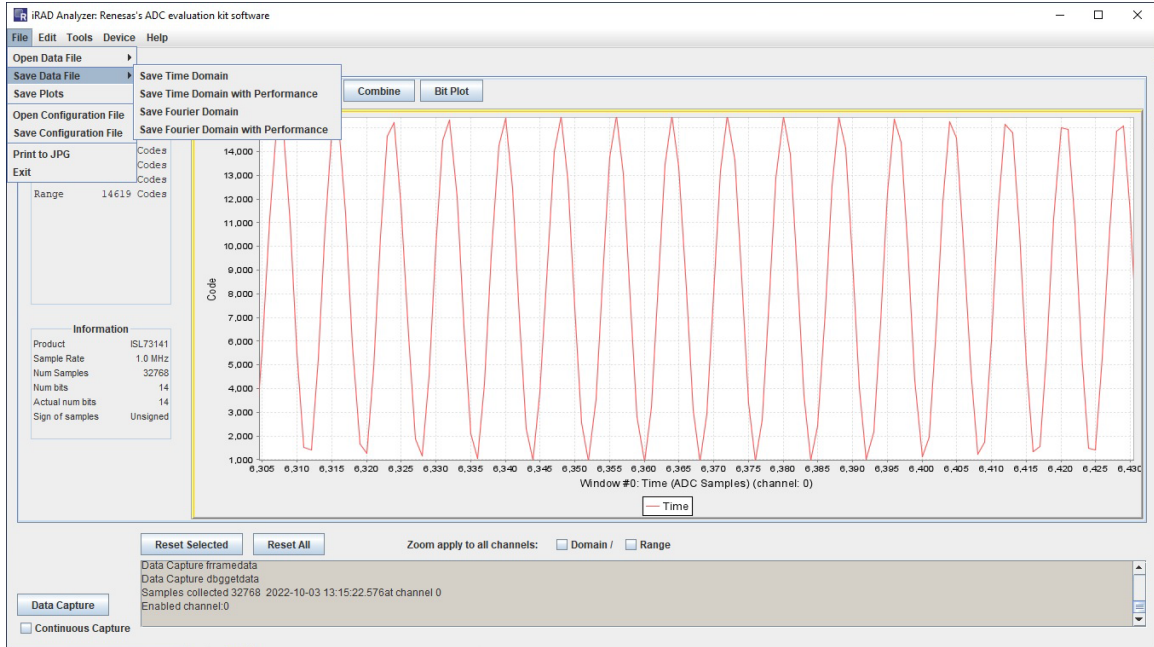

Figure 10. Using iRADAnalyzer to Save Data Files



## 2. PCB Layout Guidelines

### 2.1 ISL73141SEHF7EV1Z, ISL73141SEHFNEV1Z Evaluation Boards

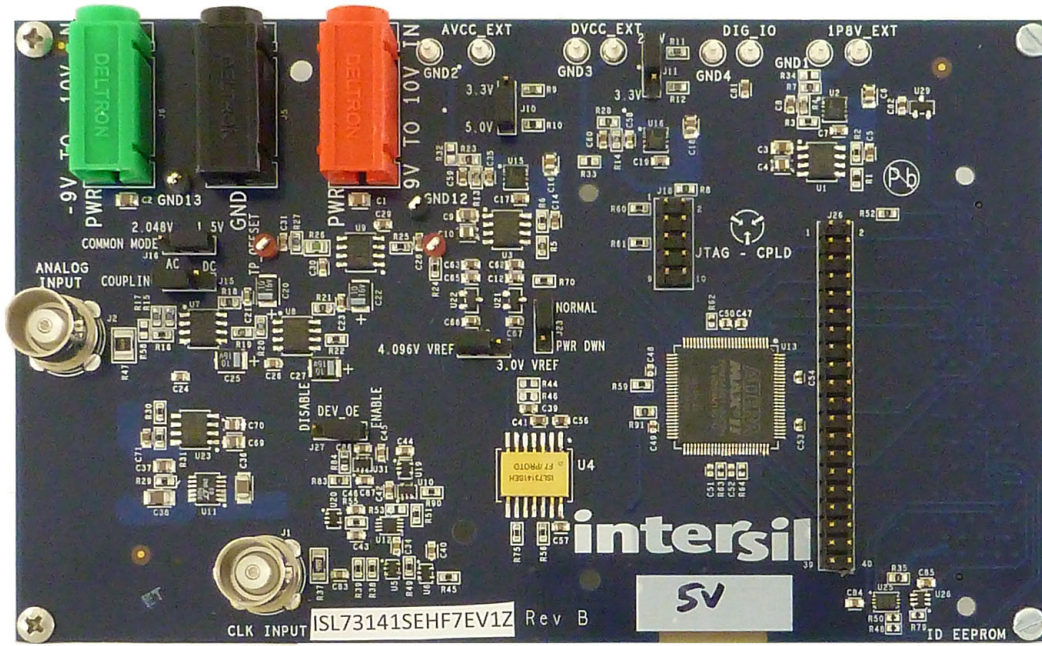

Figure 11. ISL73141SEHF7EV1Z Evaluation Board (Top)

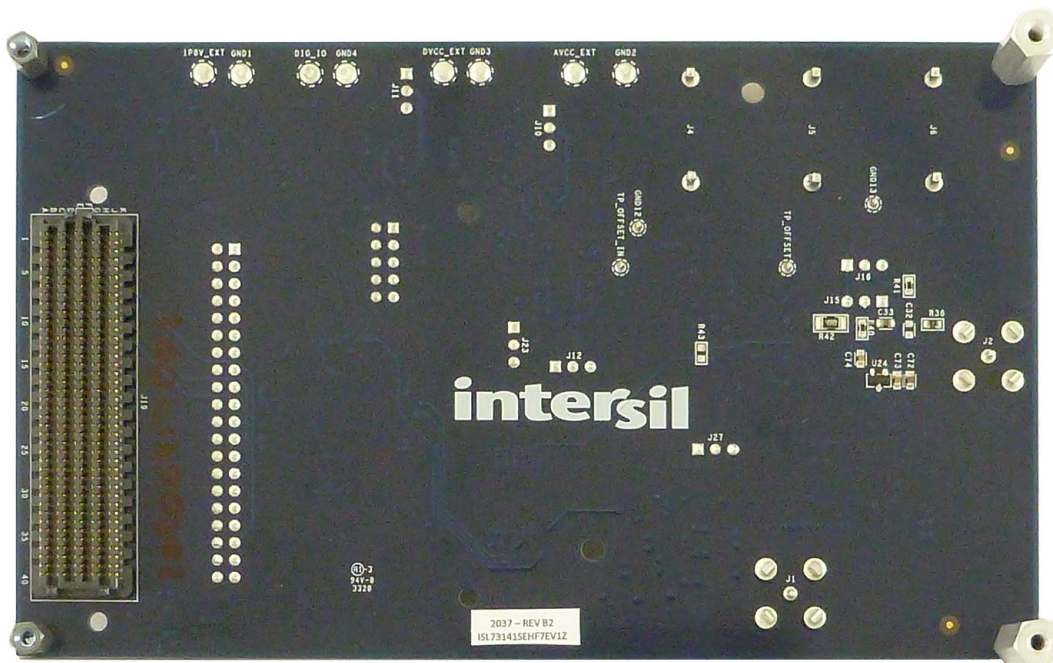

Figure 12. ISL73141SEHF7EV1Z Evaluation Board (Bottom)

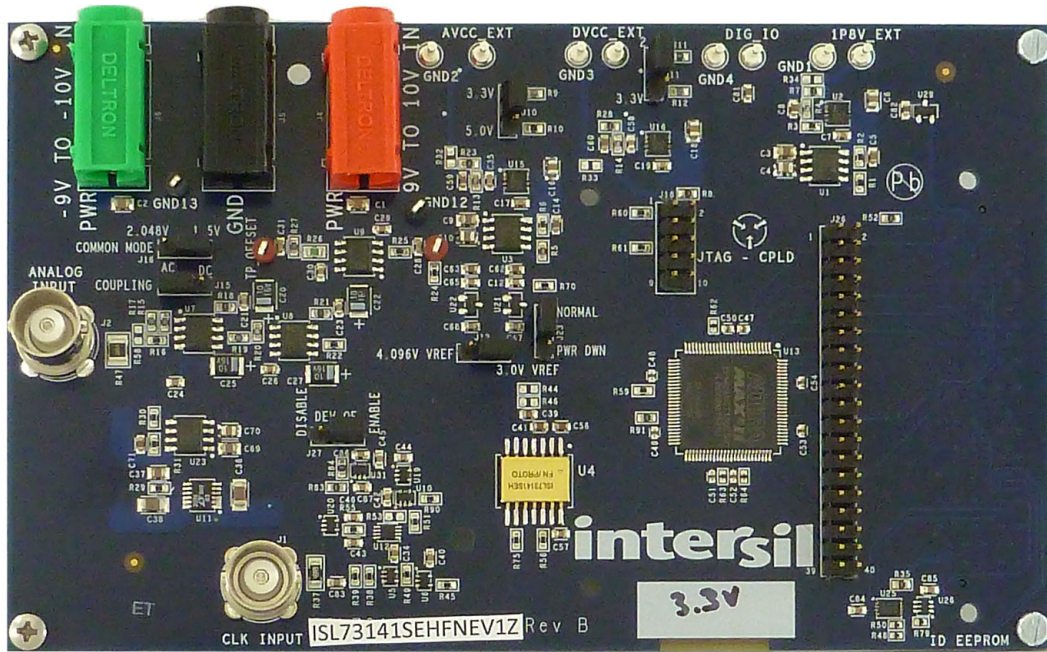

Figure 13. ISL73141SEHFNEV1Z Evaluation Board (Top)

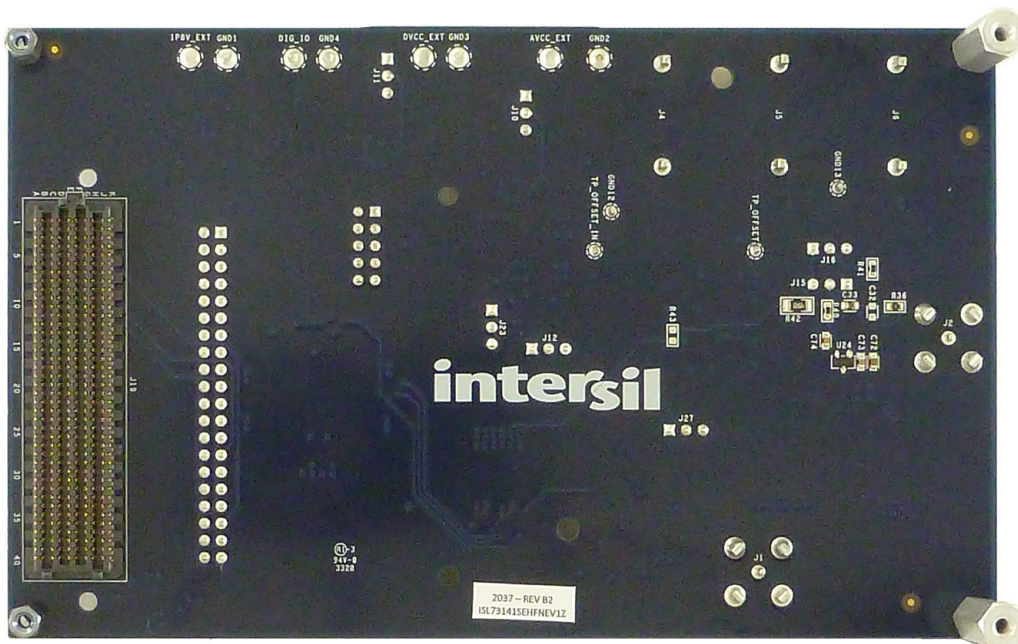

Figure 14. ISL73141SEHFNEV1Z Evaluation Board (Bottom)

## 2.2 Board Schematics

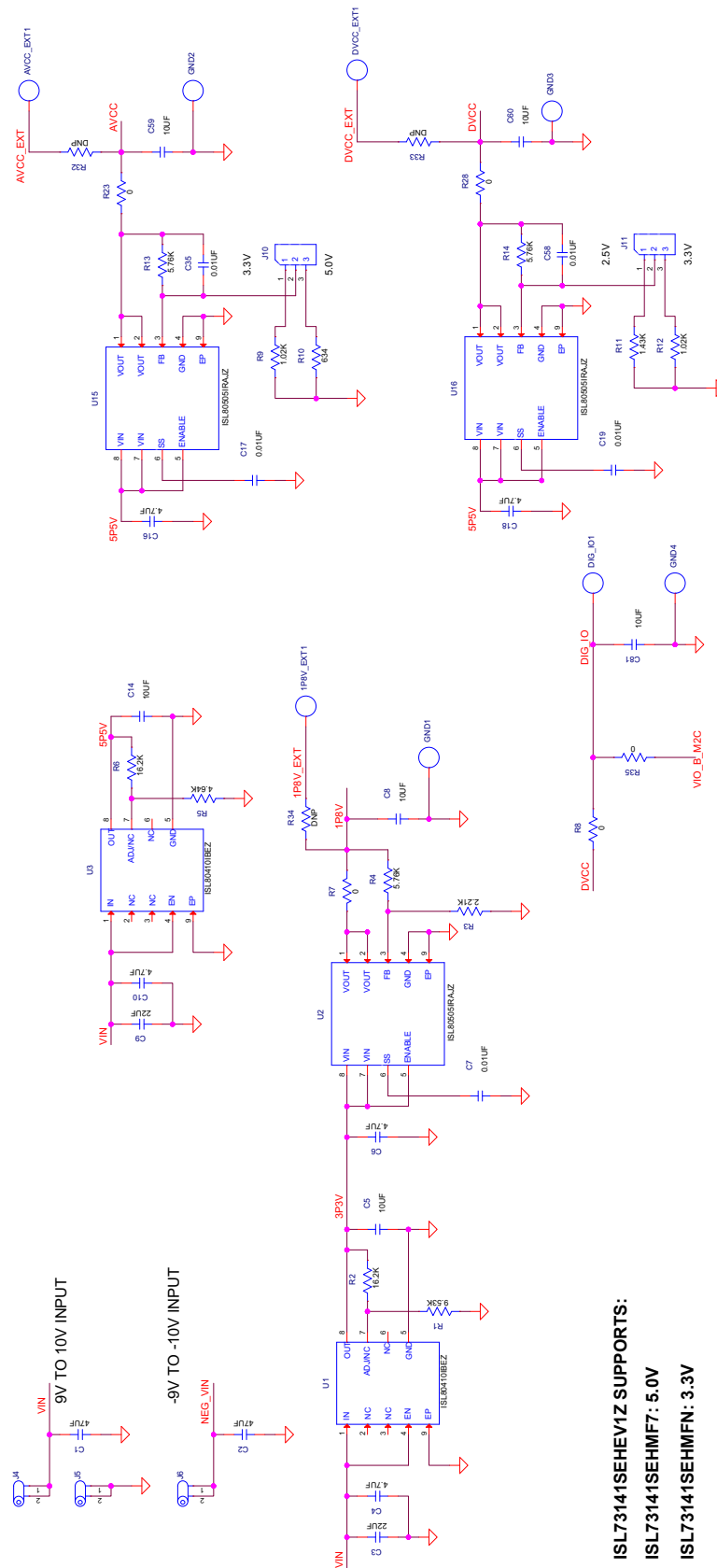

Figure 15. ISL73141SEHF Board Schematic - DUT Power Supply Circuit

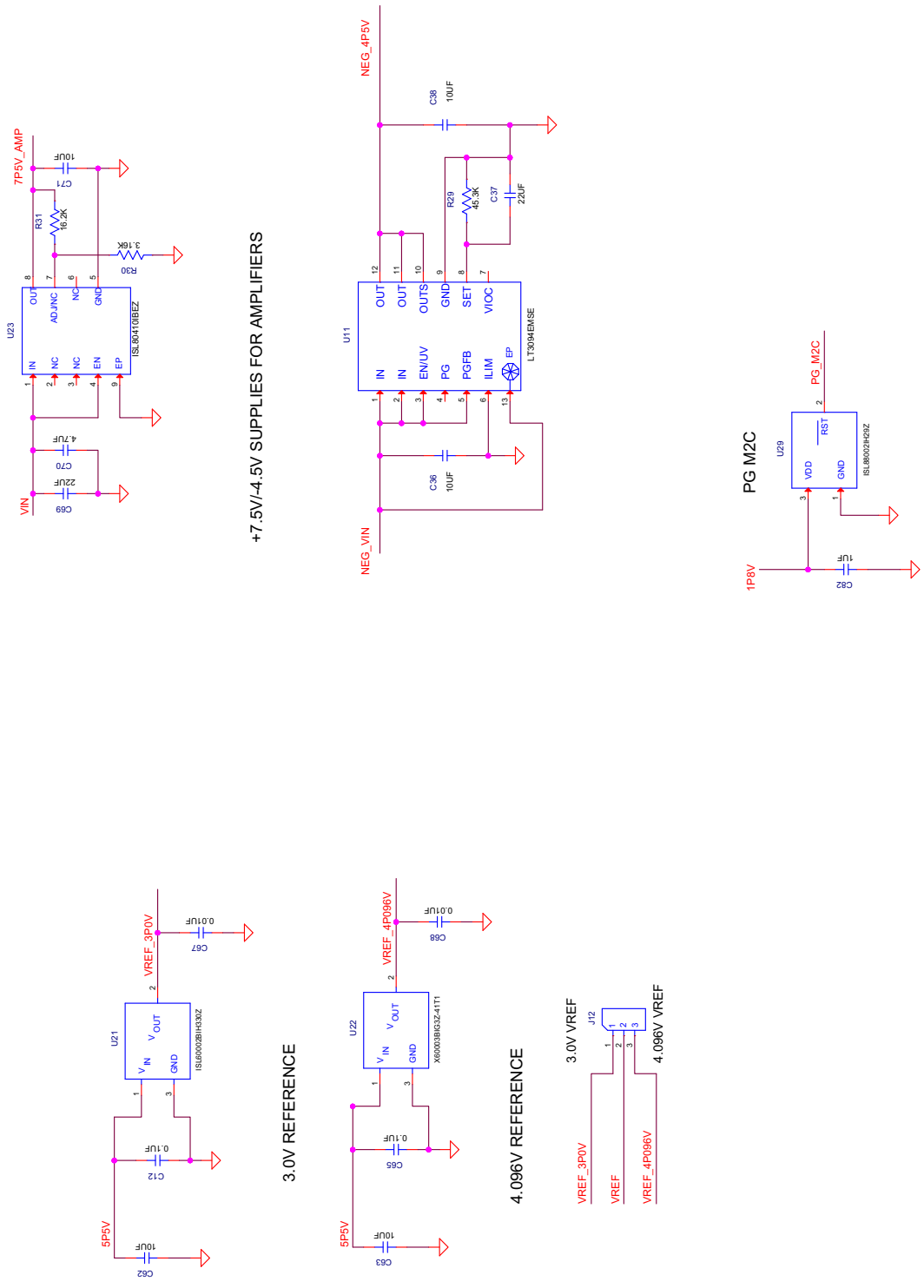

Figure 16. Amplifier Power Supply and VREF Circuits

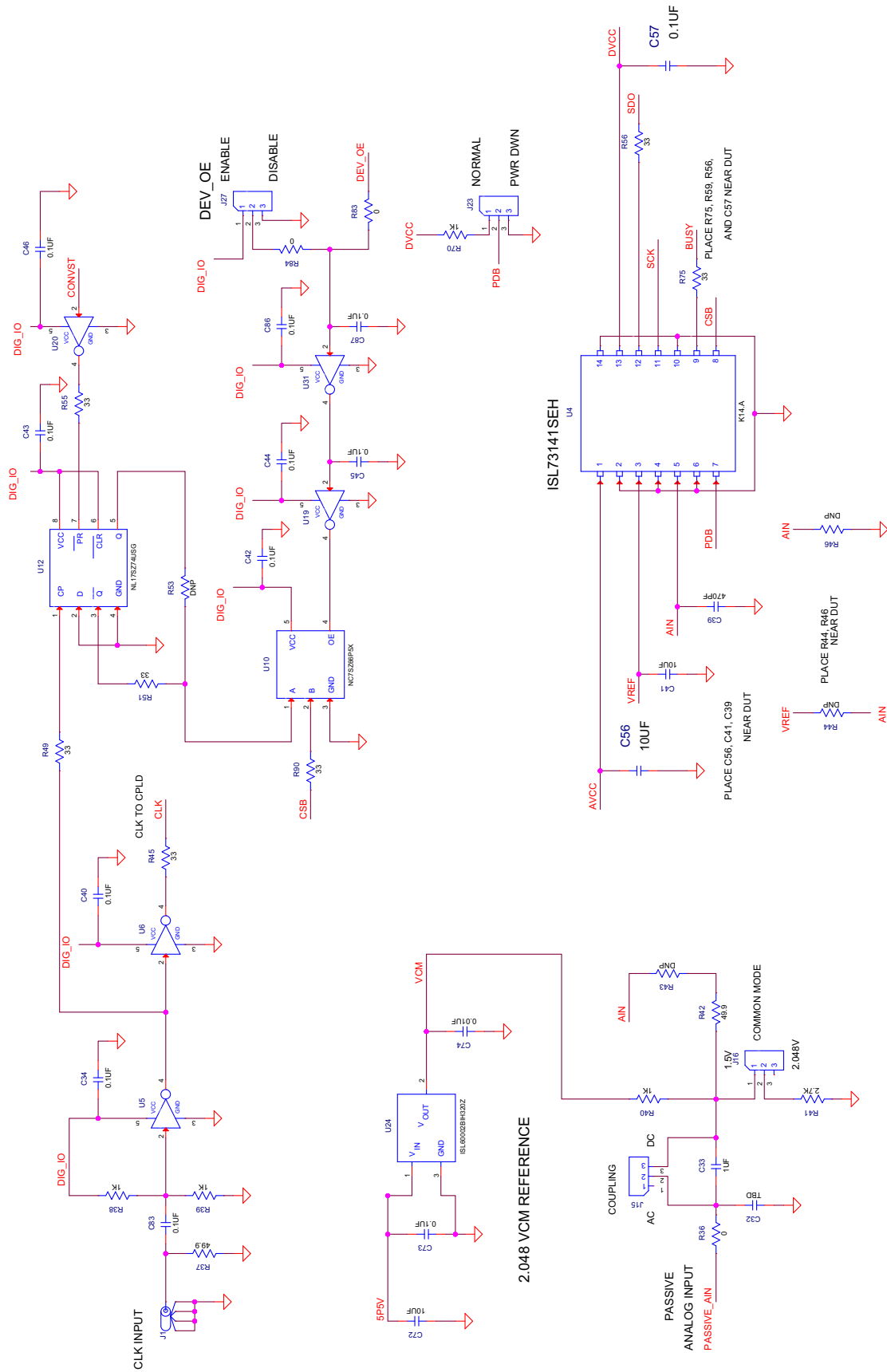

Figure 17. Passive Analog Input and Clock Circuits

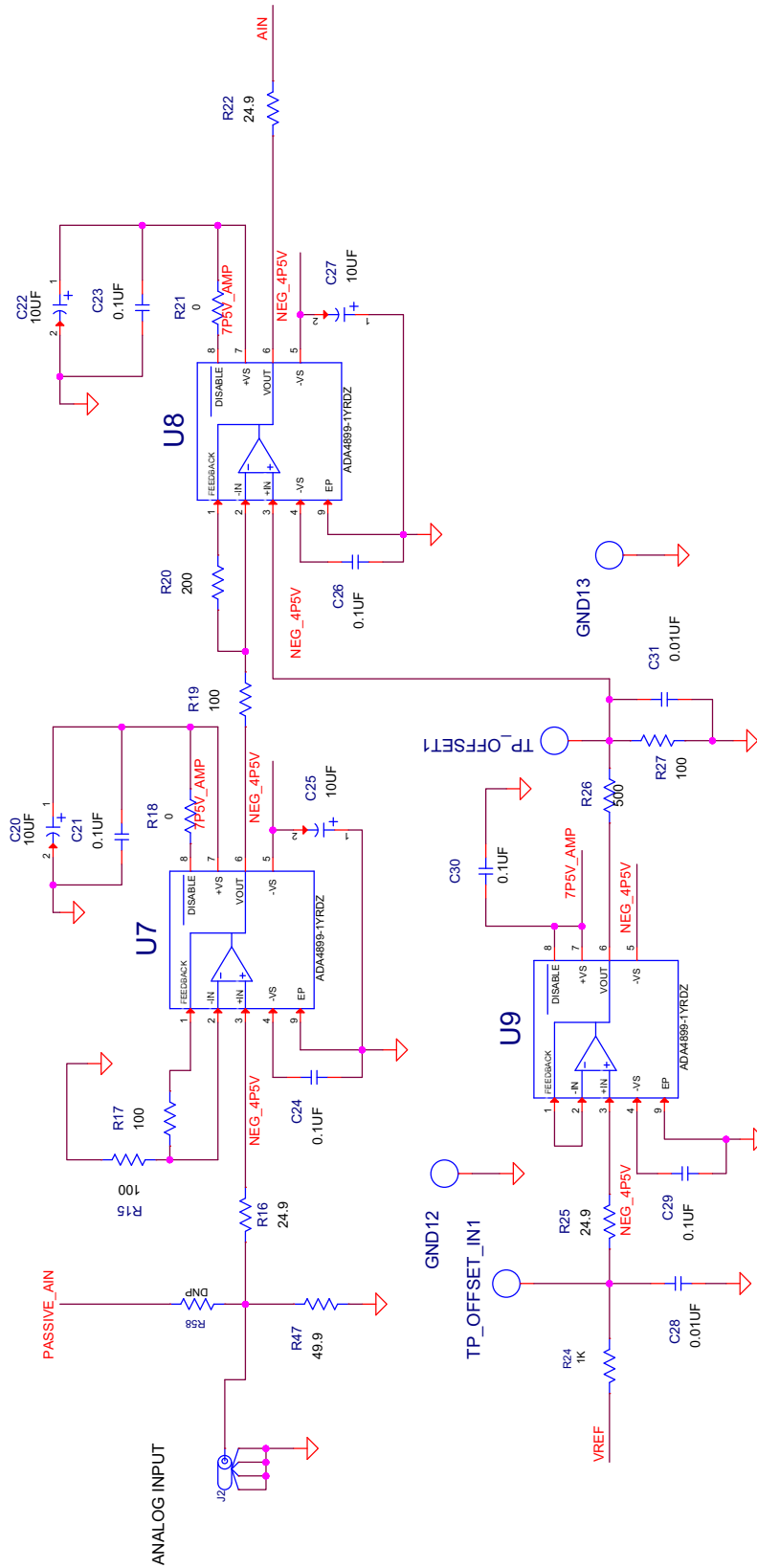

Figure 18. Analog Input Amplifier Circuit

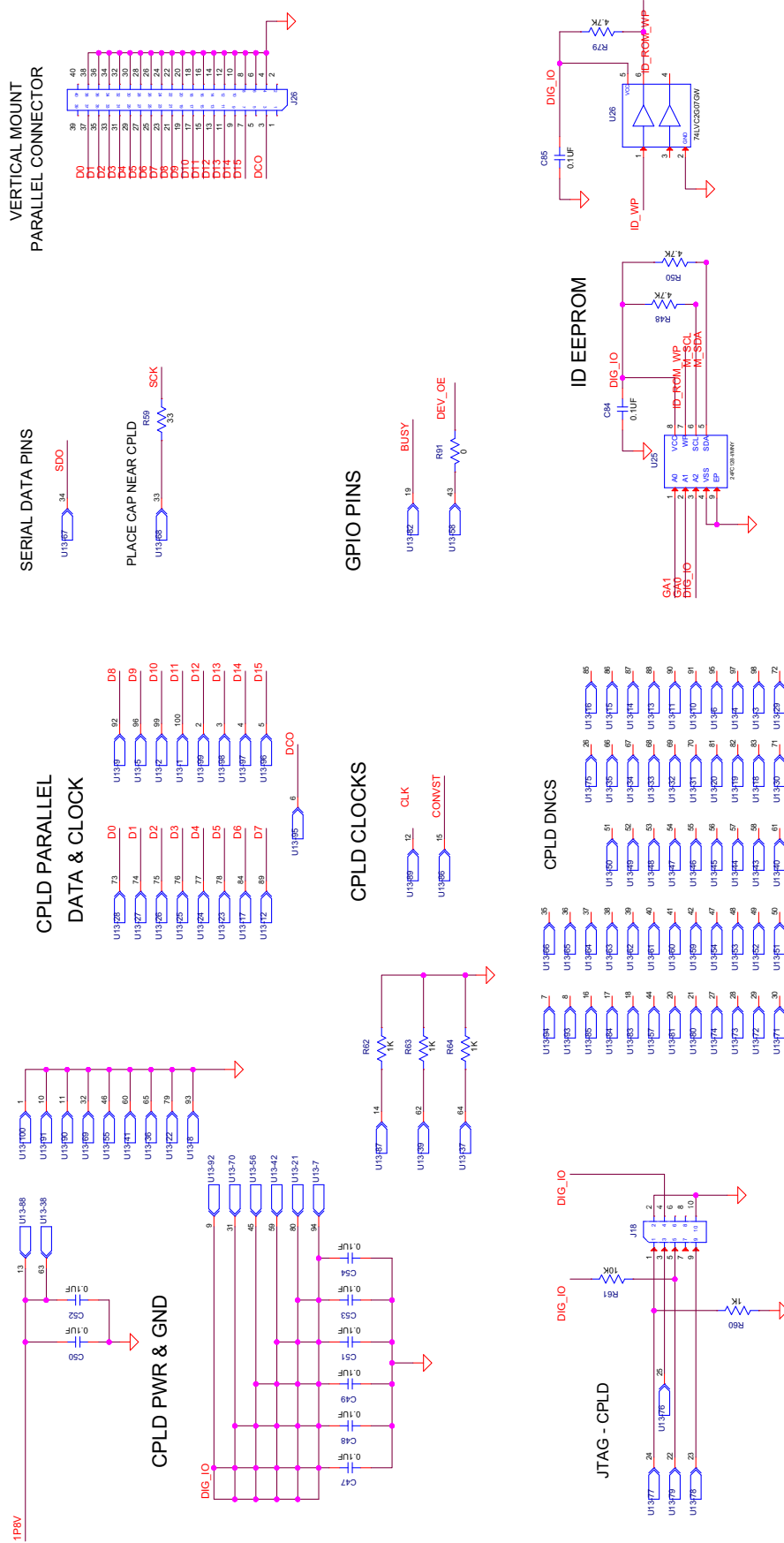

Figure 19. CPLD and Board Connector Circuits

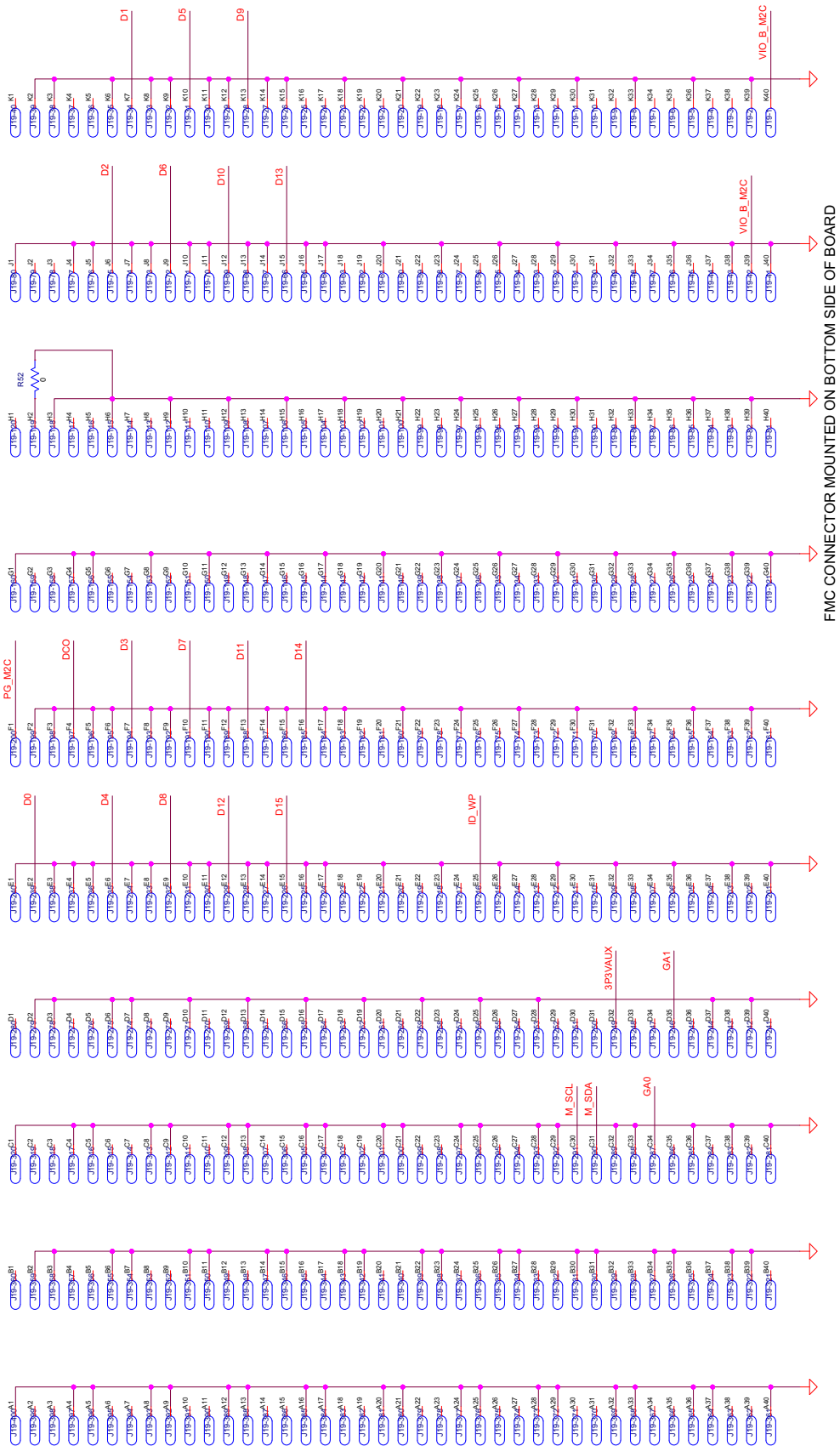

Figure 20. FMC Connector Circuit



## 2.3 Bill of Materials

| Qty | Reference Designator   | Description  | Manufacturer     | Manufacturer Part      |
|-----|--|--|------------------|------------------------|
| 1   |  | PWB-PCB, ISL73141SEHEV1Z, REV B, ROHS                      | Imagineering Inc | ISL73141SEHEV1ZREVBPCB |
| 22  | C12, C21, C23, C24, C26, C29, C30, C34, C40, C42, C43, C44, C45, C46, C57, C65, C73, C83, C84, C85, C86, C87 | CAPACITOR, SMD, 0603, 0.10µF, 50V, 10%, X7R                | TDK              | C1608X7R1H104K         |
| 6   | C4, C6, C10, C16, C18, C70   | CAP-AEC-Q200, SMD, 0805, 4.7µF, 25V, 10%, X7R, ROHS        | TDK              | CGA4J1X7R1E475K125AC   |
| 12  | C5, C8, C14, C41, C56, C59, C60, C62, C63, C71, C72, C81   | CAP, SMD, 0603, 10µF, 16V, 20%, X5R, ROHS                  | Murata           | GRM188R61C106MA73D     |
| 4   | C3, C9, C37, C69   | CAP-AEC-Q200, SMD, 0805, 22µF, 25V, 20%, X5R, ROHS         | Murata           | GRT21BR61E226ME13L     |
| 8   | C47-C54  | CAP, SMD, 0402, 0.1µF, 16V, 10%, X7R, ROHS                 | Venkel           | C0402X7R160-104KNE     |
| 10  | C7, C17, C19, C28, C31, C35, C58, C67, C68, C74  | CAP, SMD, 0603, 0.01µF, 50V, 10%, X7R, ROHS                | AVX              | 06035C103KAT2A         |
| 1   | C39  | CAP, SMD, 0603, 470pF, 50V, 5%, NP0, ROHS                  | Panasonic        | ECJ-1VC1H471J          |
| 0   | C32  | CAP, SMD, 0603, DNP-PLACE HOLDER, ROHS                     |                  |                        |
| 2   | C1, C2   | CAP, SMD, 0805, 47µF, 10V, 20%, X5R, ROHS                  | TDK              | C2012X5R1A476M125AC    |
| 4   | C20, C22, C25, C27   | CAP, TANT, SMD, B, 10µF, 16V, 10%, ROHS                    | Venkel           | TA016TCR106KBR         |
| 2   | C33, C82   | CAP, SMD, 0603, 1.0µF, 25V, 10%, X7R, ROHS                 | Taiyo Yuden      | TMK107B7105KA-T        |
| 2   | C36, C38   | CAP, SMD, 1206, 10µF, 25V, 10%, X7R, ROHS                  | Taiyo Yuden      | TMK316B7106KL-TD       |
| 8   | GND1-GND4, DIG_IO, 1P8V_EXT, AVCC_EXT, DVCC_EXT  | CONN-GEN, TURRET, SILVER, 0.082 LENGTH, 0.076 MOUNT HOLE   | Cambion          | 160-2043-02-01-00      |
| 2   | J1, J2   | CONN-BNC, RECEPTACLE, TH, 4 POST, 50Ω, SILVERCONTACT, ROHS | Amphenol         | 31-5329-51RFX          |
| 2   | TP_OFFSET, TP_OFFSET_IN  | CONN-COMPACT TEST PT, VERTICAL, RED, ROHS                  | Keystone         | 5005                   |
| 2   | GND12, GND13   | CONN-COMPACT TEST PT, VERTICAL, BLK, ROHS                  | Keystone         | 5006                   |
| 1   | J5   | CONN-PLUG, BLACK, 4mm, RA, BANA-INSUL-SDRLESS              | Deltron          | 571-0100               |
| 1   | J6   | CONN-PLUG, GREEN, 4mm, ROHS, RA, BANA-INSUL-SDRLESS        | Deltron          | 571-0400               |

| Qty | Reference Designator        | Description   | Manufacturer                | Manufacturer Part  |
|-----|-----------------------------|---|-----------------------------|--------------------|
| 1   | J4                          | CONN-PLUG, RED, 4mm, RA, BANA-INSUL-SDRLESS                           | Deltron                     | 571-0500           |
| 1   | J26                         | CONN-HEADER, 2x20, BRKAWY-2x36, 2.54mm, ROHS                          | BERG/FCI                    | 67996-272HLF       |
| 1   | J18                         | CONN-HEADER, 2x5, BRKAWY-2x36, 2.54mm, ROHS                           | BERG/FCI                    | 67996-272HLF       |
| 7   | J10-J12, J15, J16, J23, J27 | CONN-HEADER, 1x3, BREAKAWY 1x36, 2.54mm, ROHS                         | BERG/FCI                    | 68000-236HLF       |
| 1   | J19                         | CONN-SOCKET ARRAY, SMD, 400P, 0.05 PITCH, CUSTOM, ROHS                | Samtec                      | ASP-134602-01      |
| 1   | U25                         | IC-MEMORY, I <sup>2</sup> C SERIAL EEPROM, 128k, 1MHz, 8P, TDFN, ROHS | Microchip Technology        | 24FC128-I/MNY      |
| 1   | U26                         | IC-BUFFER/LINE DRIVER, NON-INVERT, OPEN DRAIN, 6P, TSSOP, ROHS        | NXP Semiconductor           | 74LVC2G07GW, 125   |
| 3   | U7-U9                       | IC-OP AMP, HI SPEED, LOW NOISE, 8P, SOIC, ROHS                        | Analog Devices              | ADA4899-1YRDZ      |
| 1   | U13                         | IC-COMPLEX PROGRAMMABLE LOGIC, 100P, TQFP, ROHS                       | Altera                      | EPM240GT100C5N     |
| 1   | U24                         | IC-2.048V PREC.VOLT.REFERENCE, SMD, 3P, SOT-23, ROHS                  | Renesas Electronics America | ISL60002BIH320Z-TK |
| 1   | U21                         | IC-3.0V PREC.VOLT.REFERENCE, SMD, 3P, SOT-23, ROHS                    | Renesas Electronics America | ISL60002BIH330Z-TK |
| 3   | U1, U3, U23                 | IC-40V, 150mA LDO REGULATOR, 8P, EPSONIC, ROHS                        | Renesas Electronics America | ISL80410IBEZ       |
| 3   | U2, U15, U16                | IC-Single 500mA, AdjVout LDO, 3x3, 8ld, DFN, Pb-FREE W/ANNEAL         | Renesas Electronics America | ISL80505IRAJZ      |
| 1   | U29                         | IC-2.92V VOLTAGE SUPERVISOR, SMD, 3P, SOT 23, ROHS                    | Renesas Electronics America | ISL88002IH29Z      |
| 1   | U11                         | IC-500mA, -2.3V, ADJ. VOLTAGE REGULATOR, 12P, MSOP, ROHS              | Linear Tech/Analog Devices  | LT3094EMSE#PBF     |
| 1   | U5                          | IC-INVERTER, SINGLE CIRCUIT/INPUT, SMD, 5P, SC70-5, ROHS              | On Semiconductor            | NC7S04P5X          |
| 4   | U6, U19, U20, U31           | IC-INVERTER, SINGLE CIRCUIT/INPUT, SMD, 5P, SC70-5, ROHS              | On Semiconductor            | NC7SVU04P5X        |
| 1   | U10                         | IC-BUS SWITCH, SPST, SMD, 5P, SC70-5, ROHS                            | On Semiconductor            | NC7SZ66P5X         |

| Qty | Reference Designator   | Description  | Manufacturer                   | Manufacturer Part |
|-----|--|--|--------------------------------|-------------------|
| 1   | U12  | IC-FLIP FLOP, 1 ELEMENT<br>D-TYPE, 8P, VFSOP, ROHS               | On Semiconductor               | NL17SZ74USG       |
| 1   | U22  | IC-4.096V,<br>PREC.VOLT.REFERENCE,<br>SMD, 3P, SOT-23, ROHS      | Renesas Electronics<br>America | X60003BIG3Z-41T1  |
| 4   | R15, R17, R19, R27   | RES-AEC-Q200, SMD, 0603,<br>100Ω, 1/10W, 0.1%, THINFILM,<br>ROHS | Panasonic                      | ERA-3AEB101V      |
| 0   | R32, R33, R34, R43,<br>R44, R46, R53, R58                      | RESISTOR, SMD, 0603, 0.1%,<br>MF, DNP-PLACE HOLDER               |                                |                   |
| 3   | R62-R64  | RES, SMD, 0402, 1k, 1/16W,<br>1%, TF, ROHS                       | Venkel                         | CR0402-16W-1001FT |
| 3   | R48, R50, R79  | RES, SMD, 0402, 4.7k, 1/16W,<br>1%, TF, ROHS                     | Venkel                         | CR0402-16W-4701FT |
| 8   | R45, R49, R51, R55,<br>R56, R59, R75, R90                      | RES, SMD, 0603, 33Ω, 1/10W,<br>1%, TF, ROHS                      | Venkel                         | CR0603-10W-33R0FT |
| 12  | R7, R8, R18, R21, R23,<br>R28, R35, R36, R52,<br>R83, R84, R91 | RES, SMD, 0603, 0Ω, 1/10W,<br>TF, ROHS                           | Venkel                         | CR0603-10W-000T   |
| 6   | R24, R38-R40, R60, R70   | RES, SMD, 0603, 1k, 1/10W,<br>1%, TF, ROHS                       | Panasonic                      | ERJ-3EKF1001V     |
| 1   | R61  | RES, SMD, 0603, 10k, 1/10W,<br>1%, TF, ROHS                      | Venkel                         | CR0603-10W-1002FT |
| 2   | R9, R12  | RES, SMD, 0603, 1.02k, 1/10W,<br>1%, TF, ROHS                    | Yageo                          | RC0603FR-071K02L  |
| 1   | R11  | RES, SMD, 0603, 1.43k, 1/10W,<br>1%, TF, ROHS                    | Panasonic                      | ERJ-3EKF1431V     |
| 3   | R2, R6, R31  | RES, SMD, 0603, 16.2k, 1/10W,<br>1%, TF, ROHS                    | Panasonic                      | ERJ-3EKF1622V     |
| 1   | R20  | RES, SMD, 0603, 200Ω, 1/10W,<br>1%, TF, ROHS                     | Venkel                         | CR0603-10W-2000FT |
| 1   | R3   | RES, SMD, 0603, 2.21k, 1/10W,<br>1%, TF, ROHS                    | Yageo                          | RC0603FR-072K21L  |
| 3   | R16, R22, R25  | RES, SMD, 0603, 24.9Ω, 1/10W,<br>1%, TF, ROHS                    | Panasonic                      | ERJ-3EKF24R9V     |
| 1   | R41  | RES, SMD, 0603, 2.7k, 1/10W,<br>1%, TF, ROHS                     | Venkel                         | CR0603-10W-2701FT |
| 1   | R30  | RES, SMD, 0603, 3.16k, 1/10W,<br>1%, TF, ROHS                    | Panasonic                      | ERJ-3EKF3161V     |
| 1   | R29  | RES, SMD, 0603, 45.3k, 1/10W,<br>1%, TF, ROHS                    | Yageo                          | RC0603FR-0745K3L  |
| 1   | R5   | RES, SMD, 0603, 4.64k, 1/10W,<br>1%, TF, ROHS                    | Yageo                          | 9C06031A4641FKHFT |
| 3   | R4, R13, R14   | RES, SMD, 0603, 5.76k, 1/10W,<br>1%, TF, ROHS                    | Venkel                         | CR0603-10W-5761FT |
| 1   | R10  | RES, SMD, 0603, 634Ω, 1/10W,<br>1%, TF, ROHS                     | Yageo                          | RC0603FR-07634RL  |

| Qty | Reference Designator | Description  | Manufacturer                | Manufacturer Part  |
|-----|----------------------|--|-----------------------------|--|
| 1   | R1                   | RES, SMD, 0603, 9.53k, 1/10W, 1%, TF, ROHS               | Venkel                      | CR0603-10W-9531FT  |
| 2   | R37, R42             | RES, SMD, 1206, 49.9Ω, 1/4W, 1%, TF, ROHS                | Vishay/Dale                 | CRCW120649R9FKEA   |
| 1   | R47                  | RES, SMD, 1210, 49.9Ω, 1/4W, 1%, TF, ROHS                | Venkel                      | CR1210-4W-49R9FT   |
| 1   | R26                  | RES, SMD, 0805, 500Ω, 1/10W, 0.1%, 25ppm, THINFILM, ROHS | KOA                         | RN732ATTD5000B25   |
| 4   | See Document #1      | SCREW, 4-40x1/4in, PHILLIPS, PANHEAD, STAINLESS, ROHS    | Building Fasteners          | PMSSS 440 0025 PH  |
| 4   | See Document #1      | STANDOFF, 4-40x5/8in, F/F, HEX, ALUMINUM, 1/4in.OD, ROHS | Mcmaster-Carr               | 91780A165  |
| 1   | U4                   | 14-bit 750/1000kspcs Precision SAR ADC                   | Renesas Electronics America | ISL73141SEHFN (3.3V Version)<br>or<br>ISL73141SEHF7 (5V Version) |

## 2.4 Evaluation Board Layout

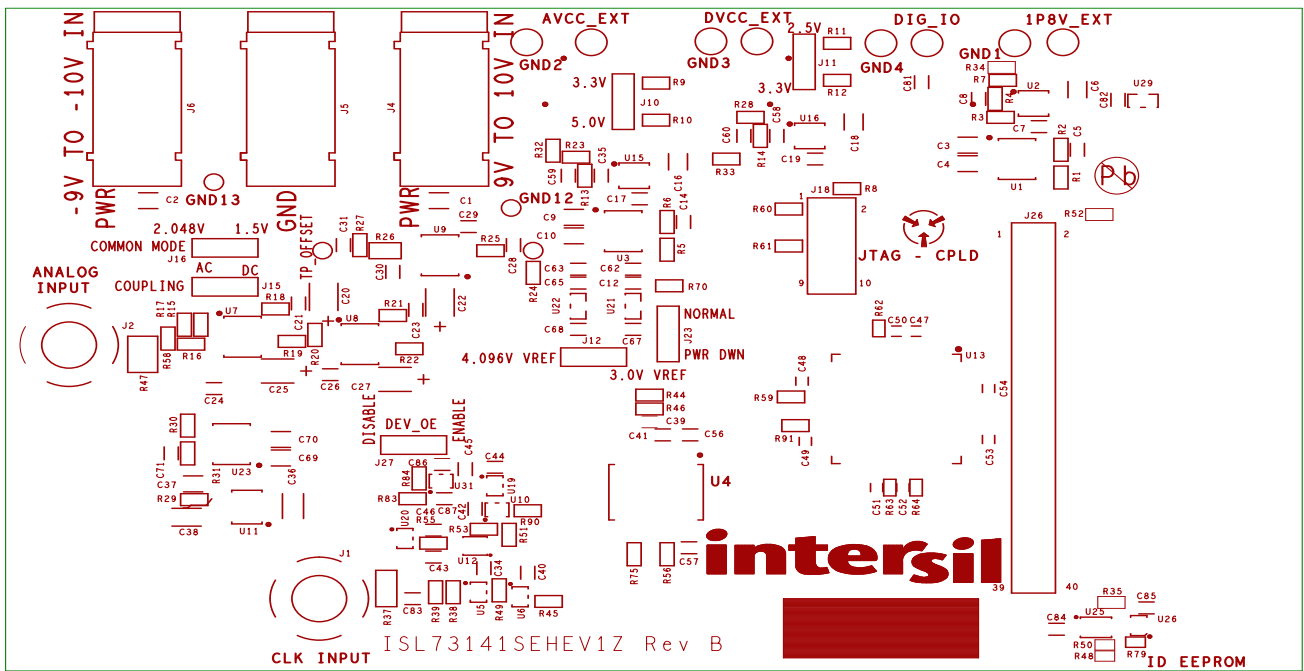

Figure 21. Top Silkscreen

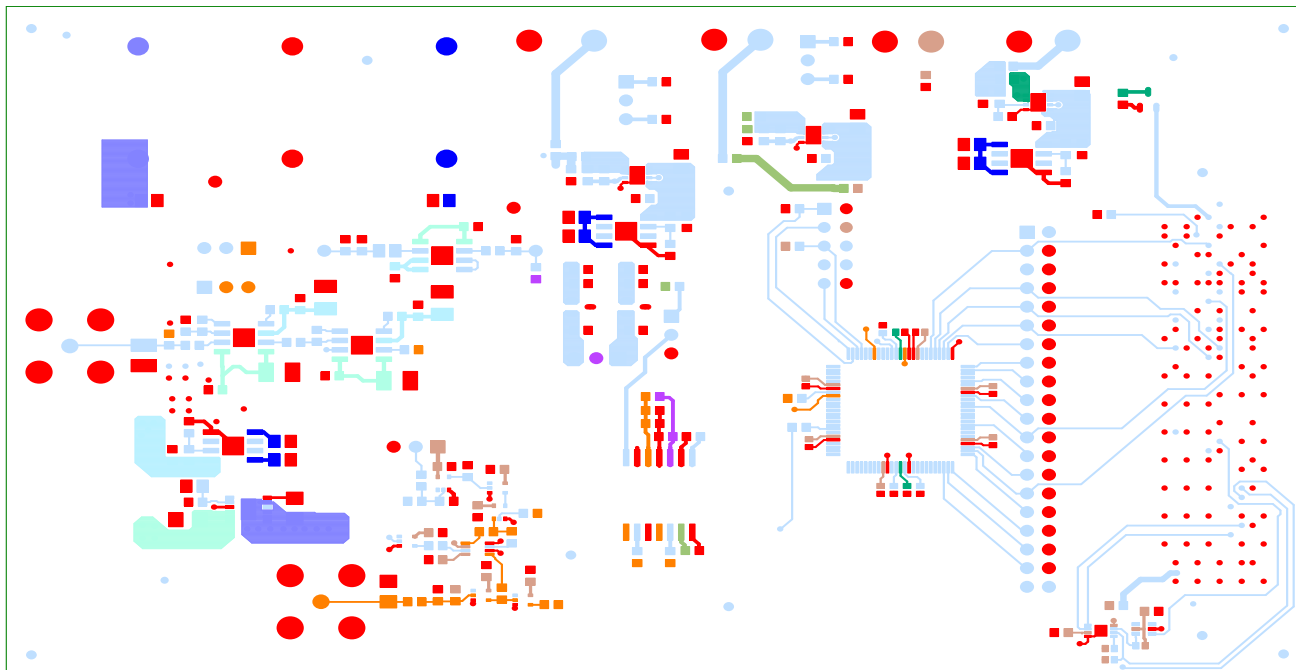

Figure 22. Top Layer

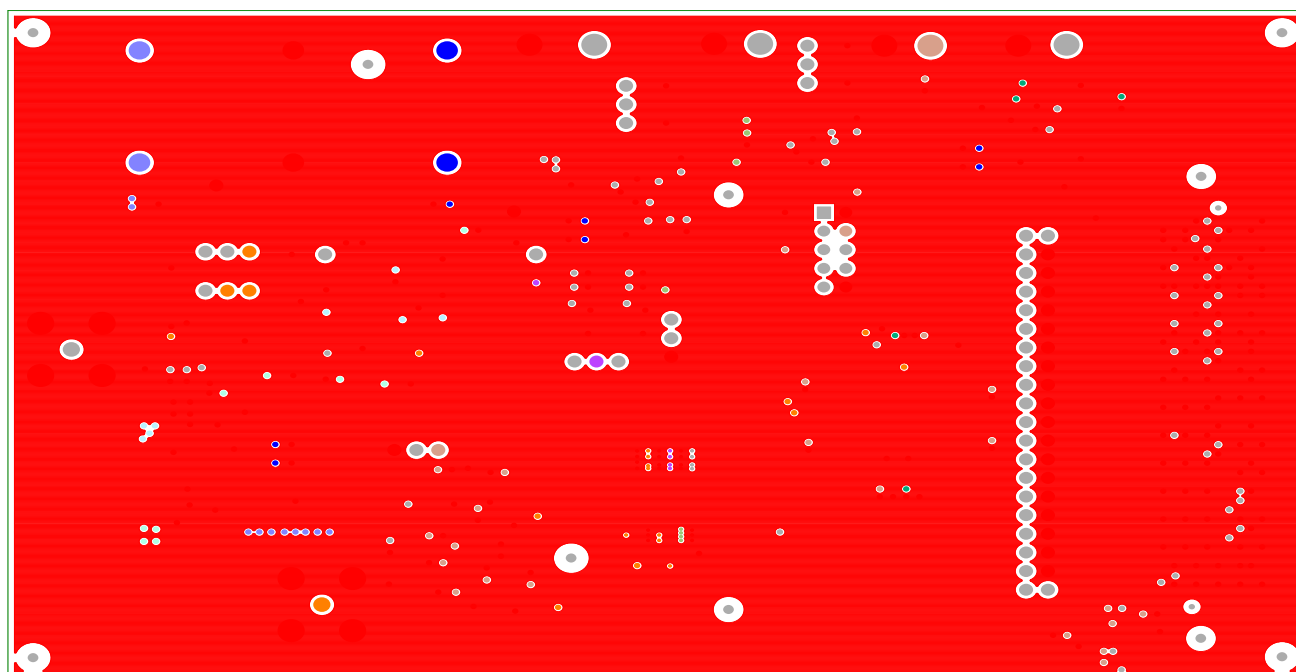

Figure 23. Layer 2

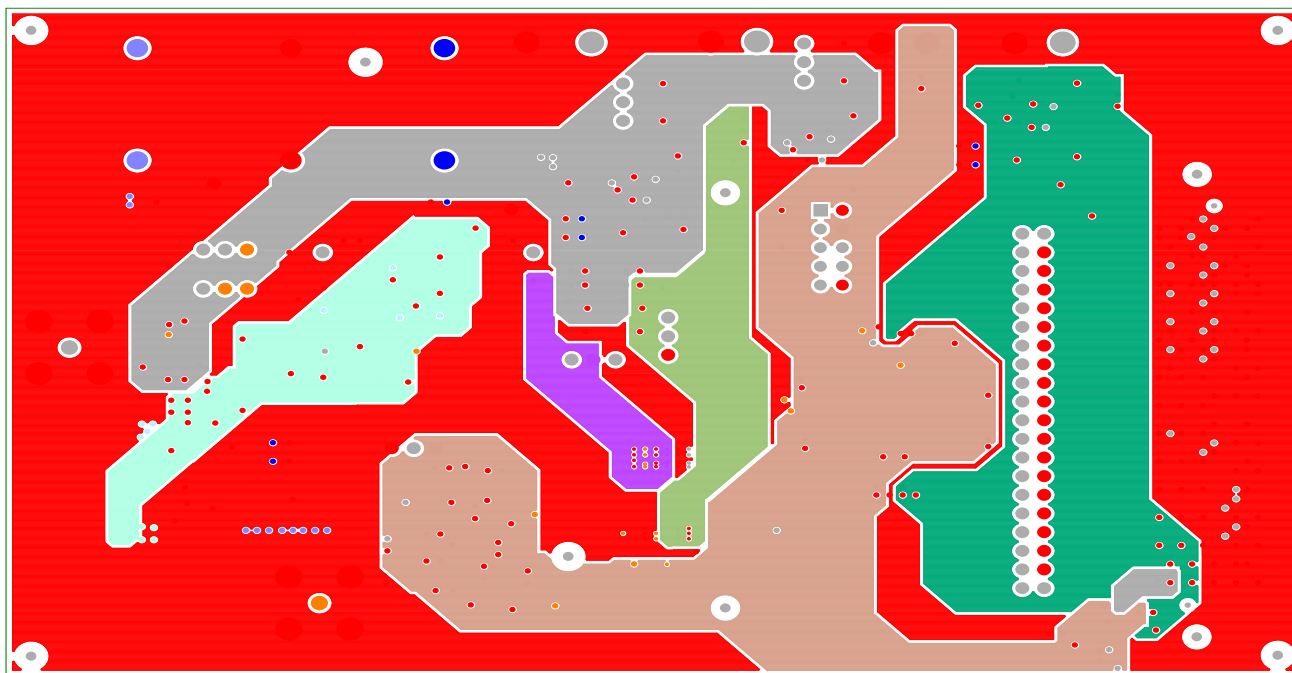

Figure 24. Layer 3

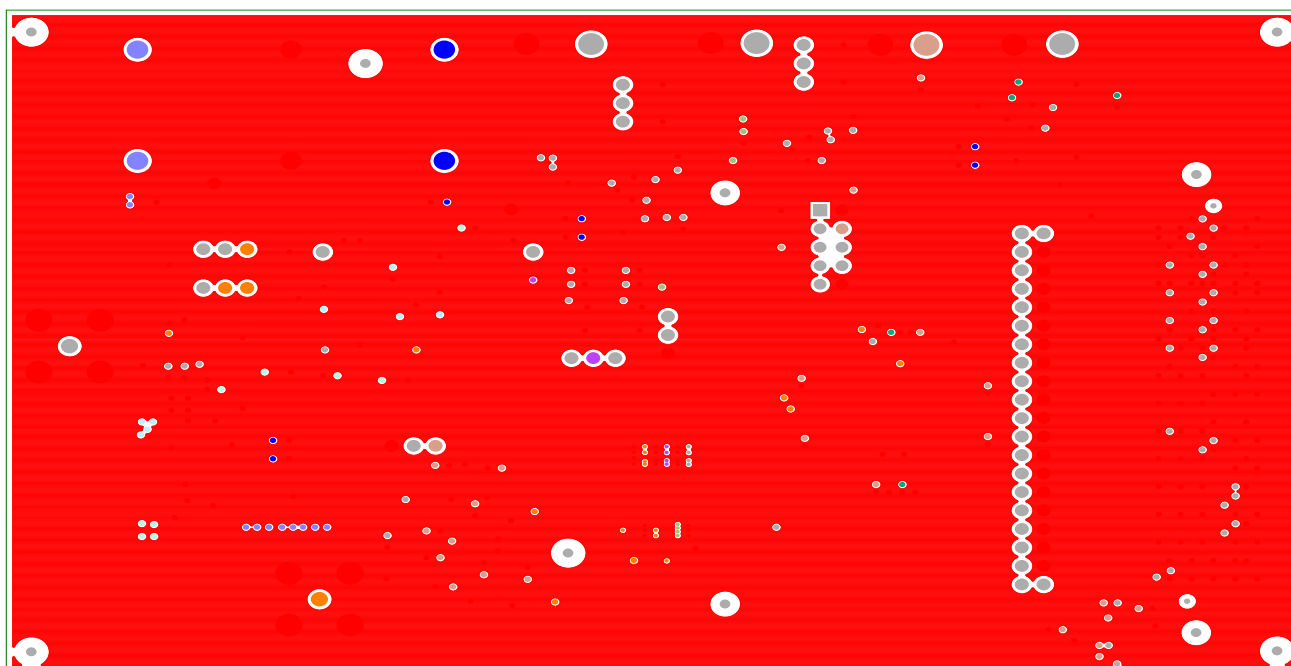

Figure 25. Layer 4

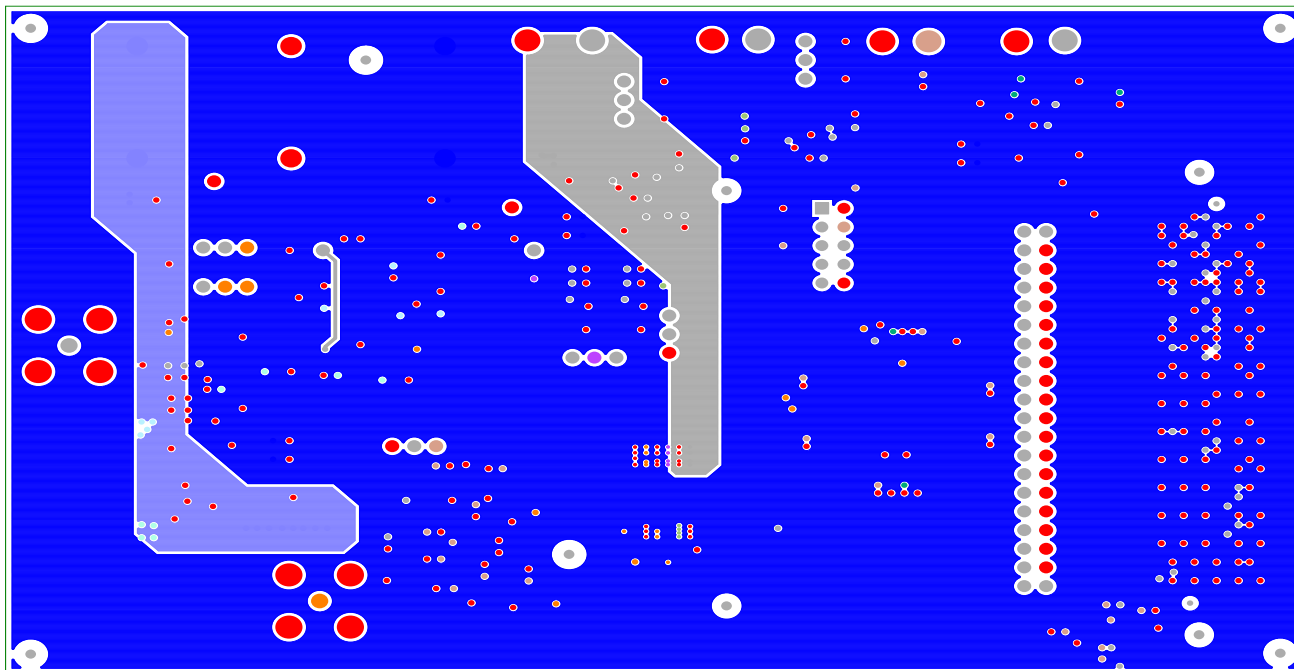

Figure 26. Layer 5

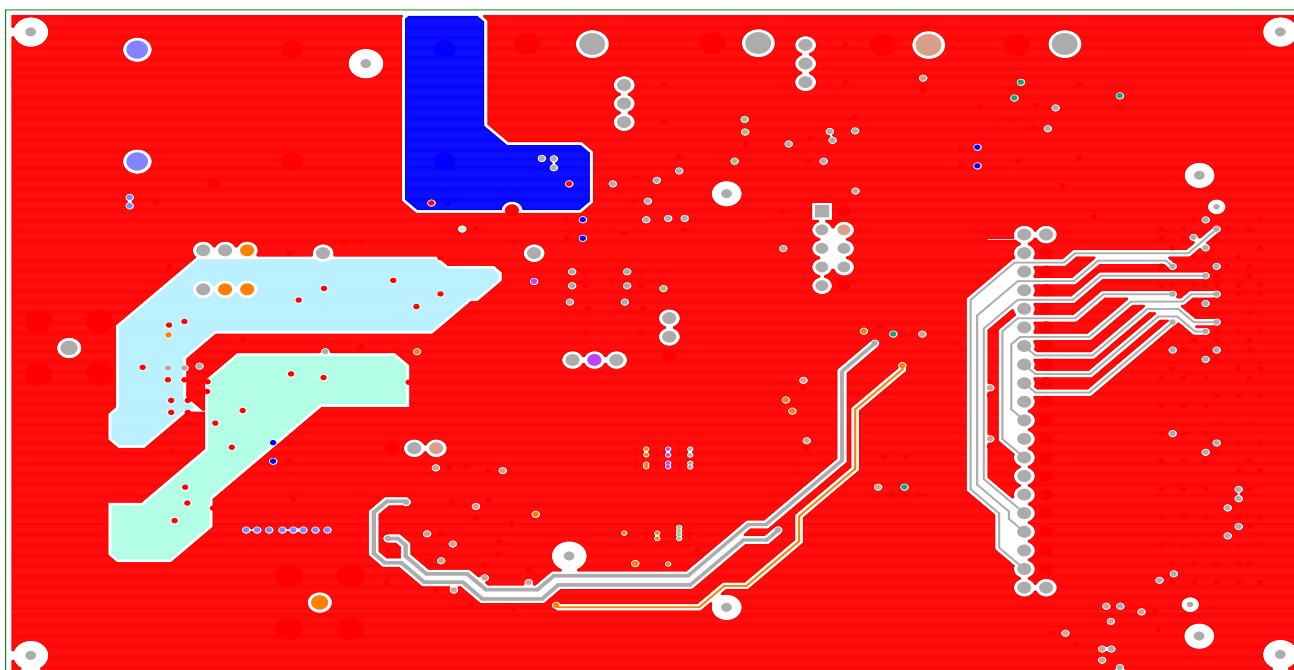

Figure 27. Layer 6

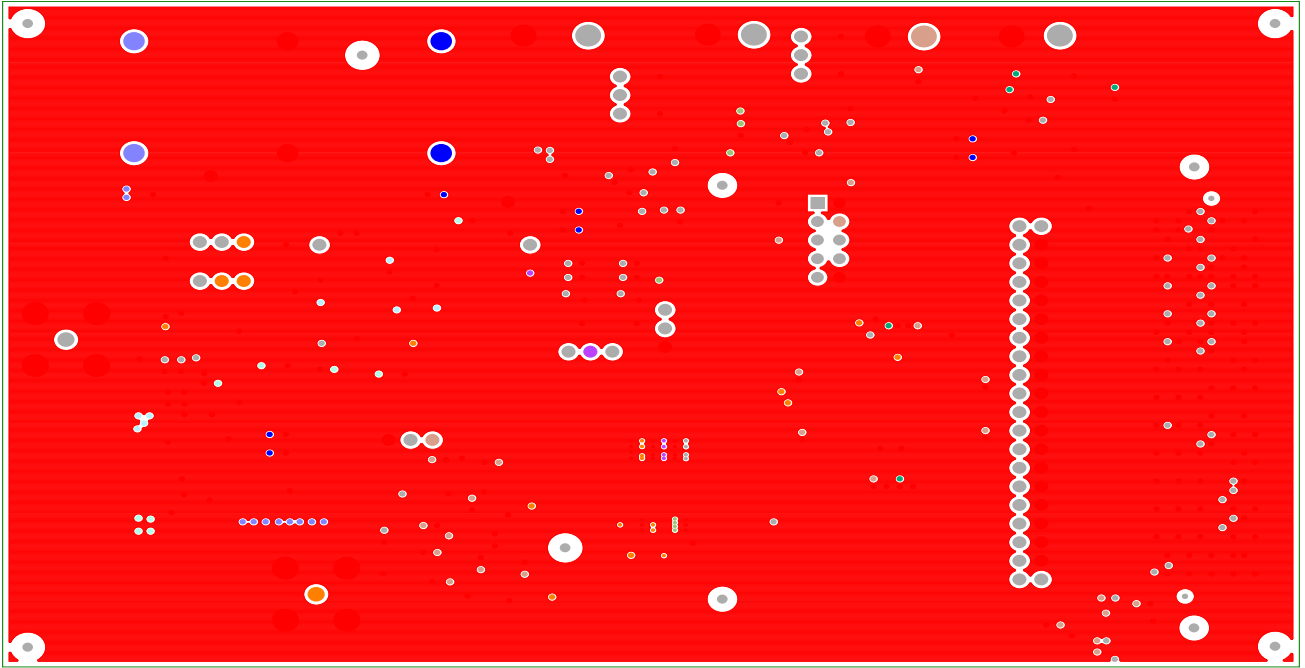

Figure 28. Layer 7

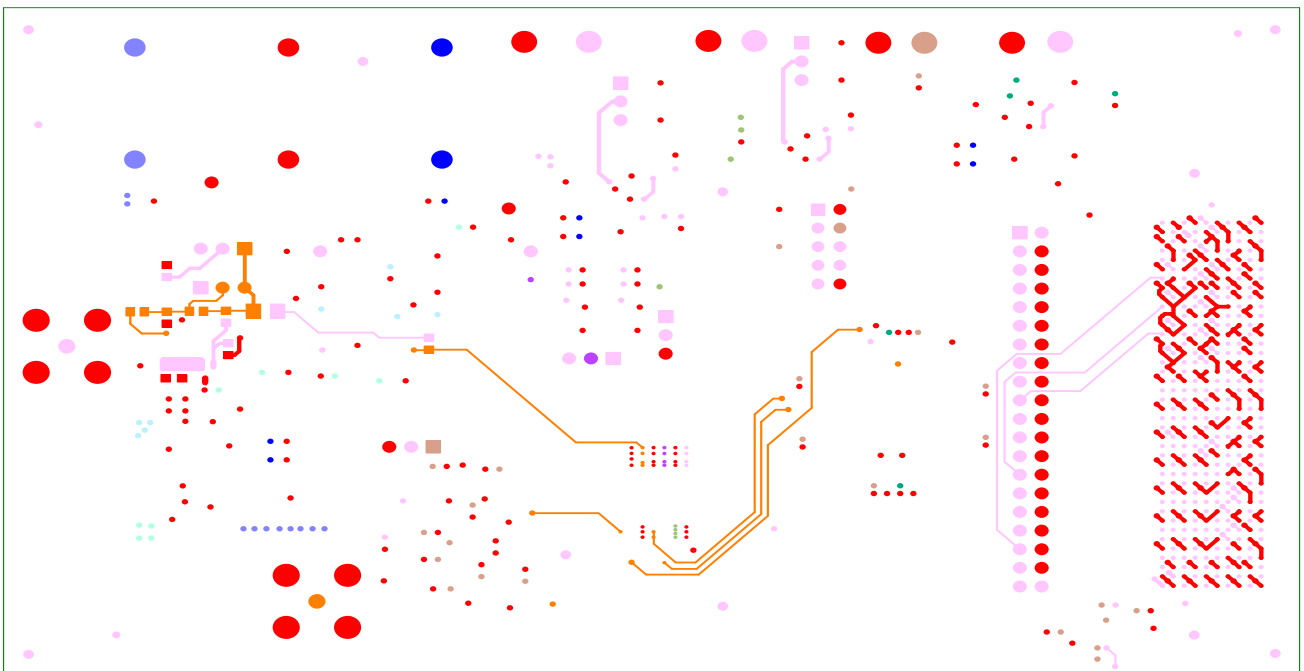

Figure 29. Bottom Layer



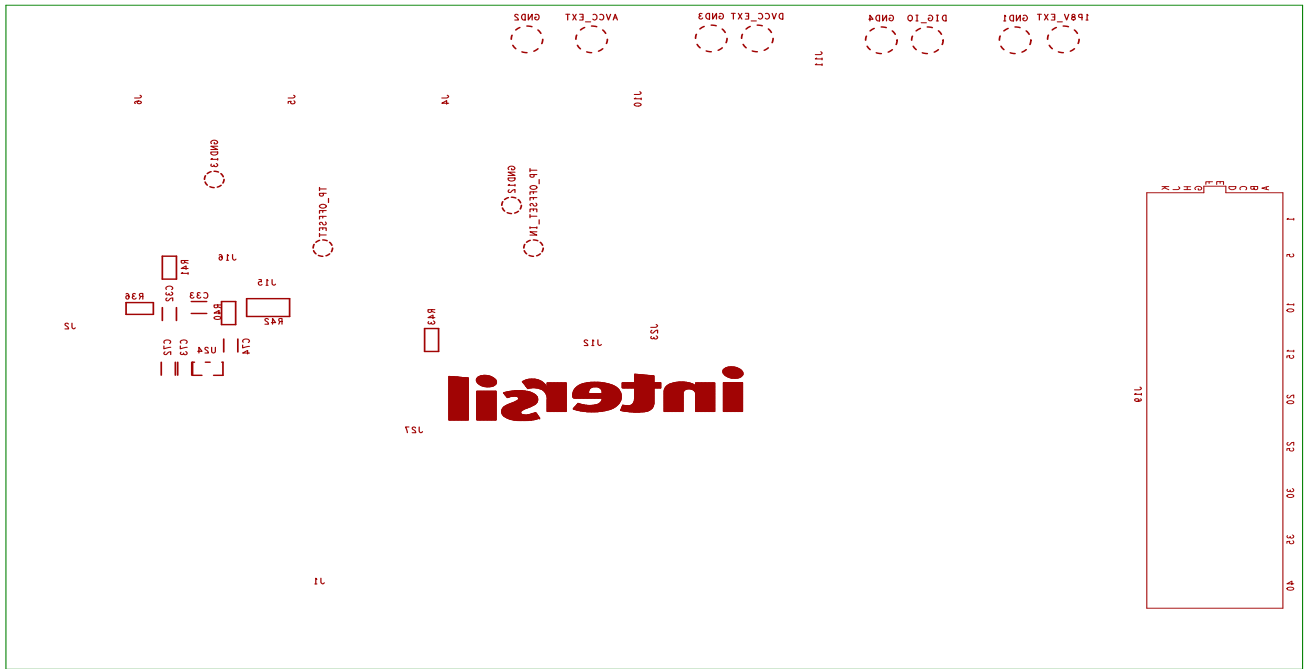

Figure 30. Bottom Silkscreen

### 3. Ordering Information

| Part Number       | Description   |
|-------------------|---|
| ISL73141SEHF7EV1Z | ISL73141SEH 14-Bit 1000ksp/740ksp SAR ADC evaluation board 5V version   |
| ISL73141SEHFNEV1Z | ISL73141SEH 14-Bit 1000ksp/740ksp SAR ADC evaluation board 3.3V version |

### 4. Revision History

| Rev. | Date         | Description  |
|------|--------------|--|
| 1.03 | Jun 18, 2024 | Applied latest template.<br>Updated Required Equipment section.  |
| 1.02 | Oct 13, 2022 | Updated Required Equipment section.<br>Updated Functional Description section.<br>Updated Connecting the Evaluation and Data Capture Boards section.<br>Updated iRADAnalyzer Data Capture - Time Domain section.<br>Updated Figures 6, 7, 8, and 10. |
| 1.01 | Apr 16, 2021 | Updated Figure 5.  |
| 1.00 | Oct 21, 2020 | Initial Release  |

## IMPORTANT NOTICE AND DISCLAIMER

RENESAS ELECTRONICS CORPORATION AND ITS SUBSIDIARIES (“RENESAS”) PROVIDES TECHNICAL SPECIFICATIONS AND RELIABILITY DATA (INCLUDING DATASHEETS), DESIGN RESOURCES (INCLUDING REFERENCE DESIGNS), APPLICATION OR OTHER DESIGN ADVICE, WEB TOOLS, SAFETY INFORMATION, AND OTHER RESOURCES “AS IS” AND WITH ALL FAULTS, AND DISCLAIMS ALL WARRANTIES, EXPRESS OR IMPLIED, INCLUDING, WITHOUT LIMITATION, ANY IMPLIED WARRANTIES OF MERCHANTABILITY, FITNESS FOR A PARTICULAR PURPOSE, OR NON-INFRINGEMENT OF THIRD-PARTY INTELLECTUAL PROPERTY RIGHTS.

These resources are intended for developers who are designing with Renesas products. You are solely responsible for (1) selecting the appropriate products for your application, (2) designing, validating, and testing your application, and (3) ensuring your application meets applicable standards, and any other safety, security, or other requirements. These resources are subject to change without notice. Renesas grants you permission to use these resources only to develop an application that uses Renesas products. Other reproduction or use of these resources is strictly prohibited. No license is granted to any other Renesas intellectual property or to any third-party intellectual property. Renesas disclaims responsibility for, and you will fully indemnify Renesas and its representatives against, any claims, damages, costs, losses, or liabilities arising from your use of these resources. Renesas' products are provided only subject to Renesas' Terms and Conditions of Sale or other applicable terms agreed to in writing. No use of any Renesas resources expands or otherwise alters any applicable warranties or warranty disclaimers for these products.

(Disclaimer Rev.1.01 Jan 2024)

### Corporate Headquarters

TOYOSU FORESIA, 3-2-24 Toyosu,  
Koto-ku, Tokyo 135-0061, Japan  
[www.renesas.com](http://www.renesas.com)

### Trademarks

Renesas and the Renesas logo are trademarks of Renesas Electronics Corporation. All trademarks and registered trademarks are the property of their respective owners.

### Contact Information

For further information on a product, technology, the most up-to-date version of a document, or your nearest sales office, please visit [www.renesas.com/contact-us/](http://www.renesas.com/contact-us/).