

ISL73141TSREFEVKIT1Z

Temperature Sensor Reference Design

The [ISL73141TSREFEVKIT1Z](#) evaluation kit and iRADNavigator software GUI are used to demonstrate the ISL73141SEH 14-bit SAR ADC in a temperature monitoring application.

The ISL73141TSREFEV1Z temperature sensor reference board evaluates the operation of the Renesas [ISL73141SEH](#) radiation hardened 14-bit 1000ksp/s SAR ADC paired with two [ISL71590SEH](#) integrated-circuit temperature sensing transducers and the [ISL71091SEH40](#) precision voltage reference. The Vorago VA41620 MCU evaluation board must be mated to the ISL73141TSREFEV1Z evaluation board to acquire data and control the heater voltage and temperature sensor configuration.

The ISL71590SEH produces an output current proportional to the absolute temperature. The device acts as a high impedance constant current regulator passing $1\mu\text{A}/\text{Kelvin}$ for supply voltages between +4V and +33V. This current creates a voltage across a $5\text{k}\Omega$ load impedance that is input to the analog input of the ISL73141SEH. The ISL71091SEH40 provides the reference voltage for the ADC (4.096V). [Figure 1](#) shows the block diagram of the reference design circuit.

This evaluation board supports three types of temperature sensing applications: 1) single temperature sensor, 2) lowest temperature in an array, and 3) average temperature in an array. The configuration of the temperature sensors is controlled using the iRADNavigator software.

The two ISL71590SEH sensors are potted with resistor heaters in MG Chemicals 8329TCS adhesive to simulate an installed application. There are two jumpers, HEATER 1 (JP1) and HEATER 2 (JP10), on the evaluation board that connect voltage into the circuit to allow current to flow through these resistors and provide a source of heat to either one or both of the temperature sensors. The iRADNavigator software is used to select the required heater voltage that is applied to the resistors. The four different voltages that can be applied are 3V, 5V, 7V, and 9V. The amount of heat generated is proportional to the voltage applied and results in a range of temperatures of approximately 29°C at 3V up to approximately 45°C at 9V in a still-air environment with an ambient temperature of 27°C .

Key Features

This evaluation board demonstrates an example signal chain used to acquire the temperature in an application while highlighting the accuracy of all three main system components: the temperature sensor, the instrumentation amplifier, and the SAR ADC.

- Accurate temperature measurement
- Multiple temperature sensor configurations
- User-friendly software GUI

Specifications

- +12V power supply input (from included DC wall power supply)
- Main system components support -55°C to $+125^\circ\text{C}$ operation
- Supporting components support -40°C to $+85^\circ\text{C}$ operation

Kit Contents

- ISL73141TSREFEV1Z ADC evaluation board
- Vorago VA41620 MCU Board
- 12V DC wall power supply - CUI SMI18-12-V-P6 or similar
- USB 2.0 cable and port on PC
- USB 2.0 cable with UART adapter - DTech DT-6554 or similar

Required Equipment

To properly operate the ISL73141TSREFEV1Z board, the following equipment is required:

- Renesas [iRADNavigator software](#)
- PC running Windows 10 or greater

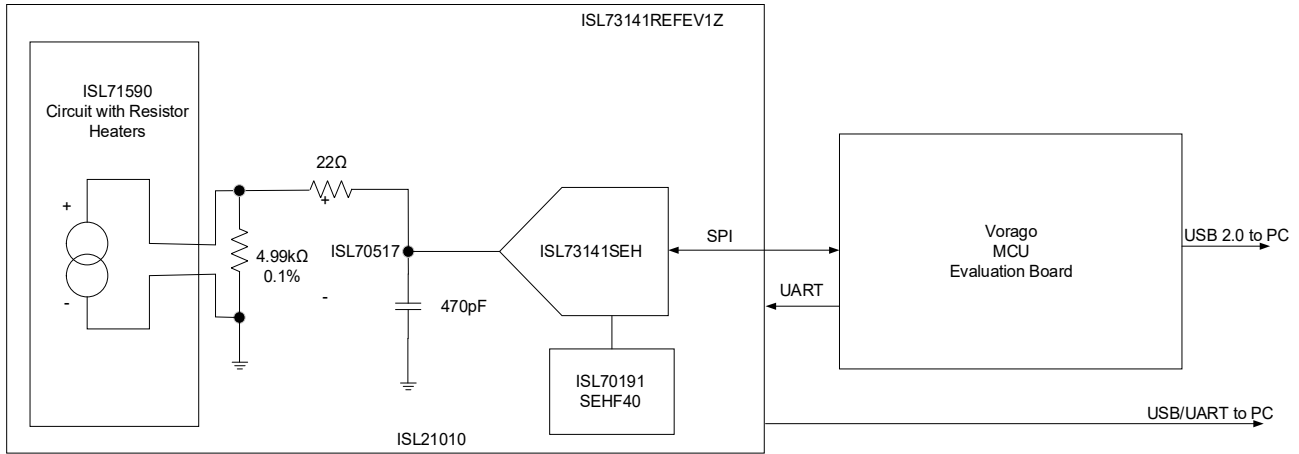

Figure 1. Block Diagram

Contents

1. Functional Description	3
1.1 Evaluation Board Operation	5
1.2 Connecting the Temperature Sensor and MCU Evaluation Boards	7
1.2.1 iRADNavigator Board Selection	8
1.2.2 iRADNavigator Temp Sensor Calibration	10
1.2.3 iRADNavigator Temperature Measurements	12
1.2.4 iRADNavigator Feature Control	14
1.2.5 iRADNavigator Temperature Sensor Configurations	17
1.3 iRADNavigator MCU Firmware Update	17
2. Board Design	20
2.1 Schematics	21
2.2 Bill of Materials	25
2.3 Board Layout	28
3. Ordering Information	31
4. Revision History	31

1. Functional Description

The ISL73141REF1Z temperature sensor reference design board can be configured for three temperature monitoring applications: 1) single sensor temperature, 2) lowest temperature, or 3) average temperature. These configurations are described further in [Table 1](#). This manual discusses the three applications, illustrating important observations from each. All observations are done at ambient room temperature (~27°C) and in still air. The default configuration in iRADNavigator is a single-sensor configuration.

Table 1. ISL73141TSREFEV1Z Temperature Sensor Configurations^[1]

Single Sensor Temperature	Lowest Temperature (Series)	Average Temperature (Parallel)
Connects U1 to R3	Connects U1 and U2 in series to R3	Connects U1 and U2 in parallel to R3

1. Install HEATER 1 (JP1) and/or HEATER 2 (JP10) jumpers to heat U1 (left) and U2 (right) ISL71590SEH, respectively.

Figure 2 shows the top side of the ISL73141TSREFEV1Z board. *Note:* The ISL71590SEH temperature sensors (U1 and U2) are located along the top of the board. These sensors reside underneath the [MG Chemicals 8329TCS](#) thermal adhesive and the heater resistors (R1 and R6). The ISL73141SEH SAR ADC and the ISL71091SEH40 precision reference are below and to the right of the temperature sensors. These parts are easily identifiable by their gold lids, branded with their respective part numbers.

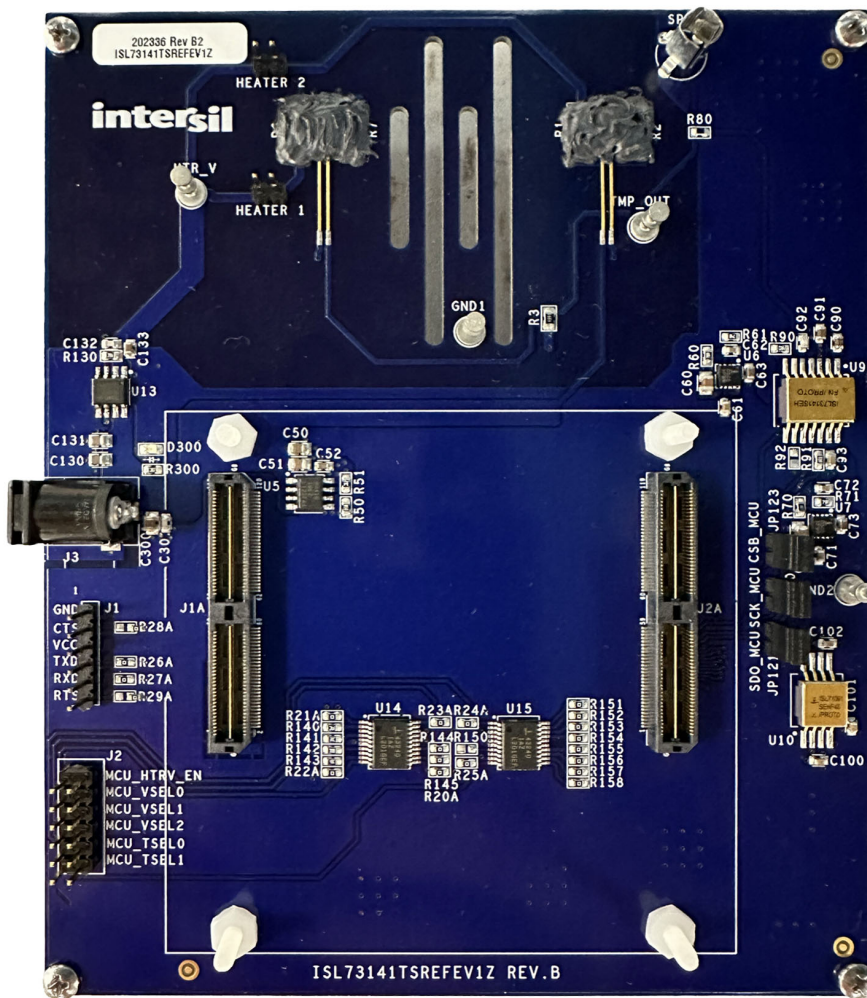

Figure 2. ISL73141TSREFEV1Z Evaluation Board Top

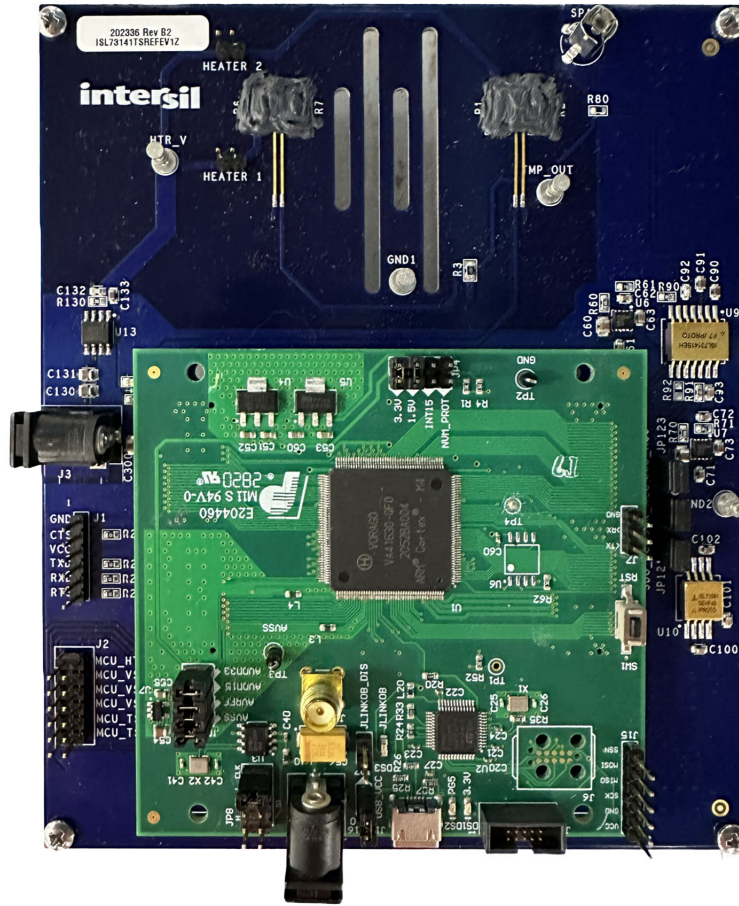

Figure 3. ISL73141TSREFEV1Z Evaluation Board with Vorago VA41620 MCU Evaluation Board

Figure 3 shows the Vorago VA41620 evaluation board mated to the ISL73141TSREFEV1Z temperature sensor evaluation board. Renesas power products ISL80410 and ISL80505 provide the voltages for the various supply domains, while the ISL71091SEH40 precision reference provides the reference voltage for the ISL73141SEH. These main signal chain components are radiation hardened products in ceramic hermetic packages from the temperature sensor to the precision reference and the ADC. The Vorago VA41620 MCU is also radiation hardened by design. The remaining components are commercial products that are not radiation hardened nor support extended temperatures used in a typical space application.

Power for the temperature sensor evaluation board is provided by a 12V DC wall supply, which is connected to J3. A USB 2.0 to UART cable is connected to J1 to collect the ADC data from the MCU, which is subsequently processed in the iRADNavigator software GUI. Power is provided through the USB 2.0 cable that connects to J17 for the Vorago VA41620 evaluation board.

1.1 Evaluation Board Operation

The ISL71590SEH temperature sensor highlighted by this evaluation board produces a current converted to a voltage by R_3 , a precision 4.99k Ω resistor with a 0.1% tolerance. This connection is highlighted in Figure 4. The current is proportional to the absolute temperature; therefore, for a room temperature environment of approximately 27°C, the absolute temperature is 300K, and the current from the temperature sensor is 300 μ A, which produces an output voltage of approximately 300mV across the 4.99k Ω load resistor.

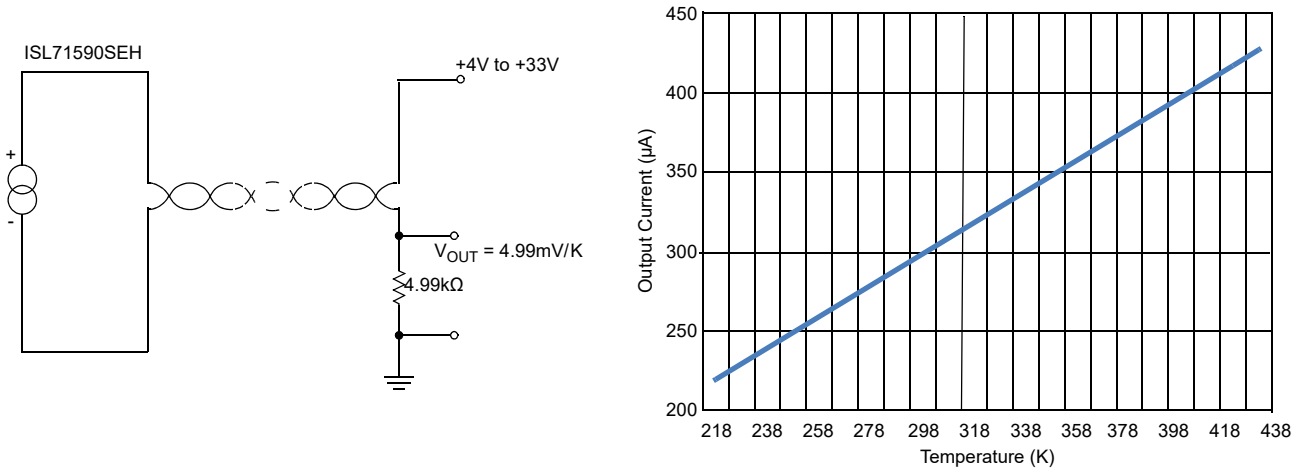

Figure 4. ISL71590SEH Single Sensor Example Circuit and Current vs Temperature Plot

The single sensor configuration of the ISL73141TSREFEV1Z evaluation board connects the ISL71590SEH temperature sensor, as shown in Figure 4. The voltage generator across the 4.99k Ω load resistor (R_3) is input to the ISL73141SEH SAR ADC. The ADC has its full-scale value set with $V_{REF} = 4.096V$ by the ISL71091SEH40 precision reference. Setting the reference voltage to 4.096V allows the ADC to sample positive and negative temperatures from the ISL71590SEH temperature sensor. For the case of the single temperature sensor configuration on the ISL73141TSREFEV1Z evaluation board, sensor U1 is selected, and sensor U2 is disconnected from the circuit.

The ISL71590SEH temperature sensors can also be configured into an average temperature sensing scheme, as shown in Figure 5. Connecting several of these temperature sensors in parallel results in the sum of the individual currents flowing through the load resistor R_3 . This allows the average temperature of the parallel temperature sensors to be expressed as a voltage and can be found by dividing the voltage on the load resistor by the number of sensors in the parallel array. If two temperature sensors are connected in parallel and are at an ambient temperature of 25°C this results in a total current of 596 μ A through the 4.99k Ω load resistor R_3 produces a voltage of 2.97404V across the 4.99k Ω load resistor R_3 . To find the average voltage and, therefore, the temperature, in this case, the measured voltage is divided by two, resulting in a voltage of 1.48702V, which is 298K or 25°C.

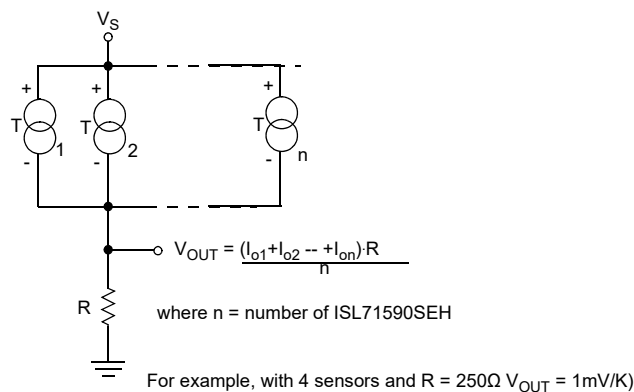

Figure 5. ISL71590SEH Parallel Sensor Example Circuit

The ISL73141TSREFEV1Z evaluation board also allows the two ISL71590SEH temperature sensors to be connected in a series circuit configuration. In a series circuit configuration, as shown in Figure 6, the temperature sensor reading the lowest temperature dominates and sets the circuit current. As the higher temperature sensor(s) tries to output more current, it is limited by the series current of the sensor with the lowest temperature. *Note:* The maximum number of sensors connected in series equals the voltage applied divided by 4V because each temperature sensor requires 4V to be adequately biased when the temperature is the same or similar across all the temperature sensors. For more temperature sensor configuration examples, refer to the [ISL71590SEHEV1Z](#) manual.

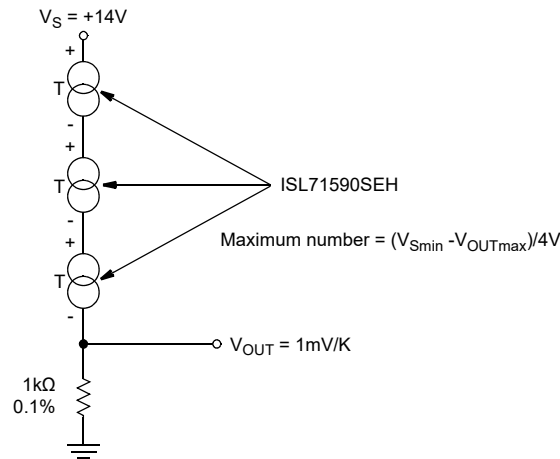

Figure 6. ISL71590SEH Series Sensor Example Circuit

The voltage from the R_3 load resistor in the temperature sensor circuit is connected to the analog input of the ISL73141SEH. The ISL73141SEH input range is set by its VREF input, which the ISL71091SEH40 drives to 4.096V. With the 4.99kΩ precision resistor, the output voltage range from the temperature sensor circuit can range from 1.08720V at -55°C with a single sensor to 3.97204V at +125°C with the two sensors connected in parallel. This is well within the usable input range of 0 to 4.096V for the ISL73141SEH.

The ISL73141SEH, ISL71590SEH, and ISL71091SEH40 devices on the evaluation board support operation from -55°C to +125°C. However, many of the components used on the evaluation board support a commercial temperature range of -40°C to +85°C. This evaluation board operates under ambient temperature conditions at or near 25°C for evaluation purposes.

1.2 Connecting the Temperature Sensor and MCU Evaluation Boards

1. Connect the supplied Vorago VA41620 MCU evaluation board to the ISL73141TSREFEV1Z board.
2. Connect the supplied USB Type A to Micro USB cable from the PC to the Vorago VA41620 MCU evaluation board.
3. Connect the supplied CUI 12V switching power supply to the ISL73141TSREFEV1Z board.
4. Wait for the LED DS2 to begin flashing on the Vorago VA41620 MCU board.
5. Connect the supplied DTech FTDI USB to the UART cable from the PC to the ISL73141TSREFEV1Z board.
6. Press the reset button on the Vorago VA41620 MCU evaluation board to load the firmware from the MRAM into the VA41620 MCU.

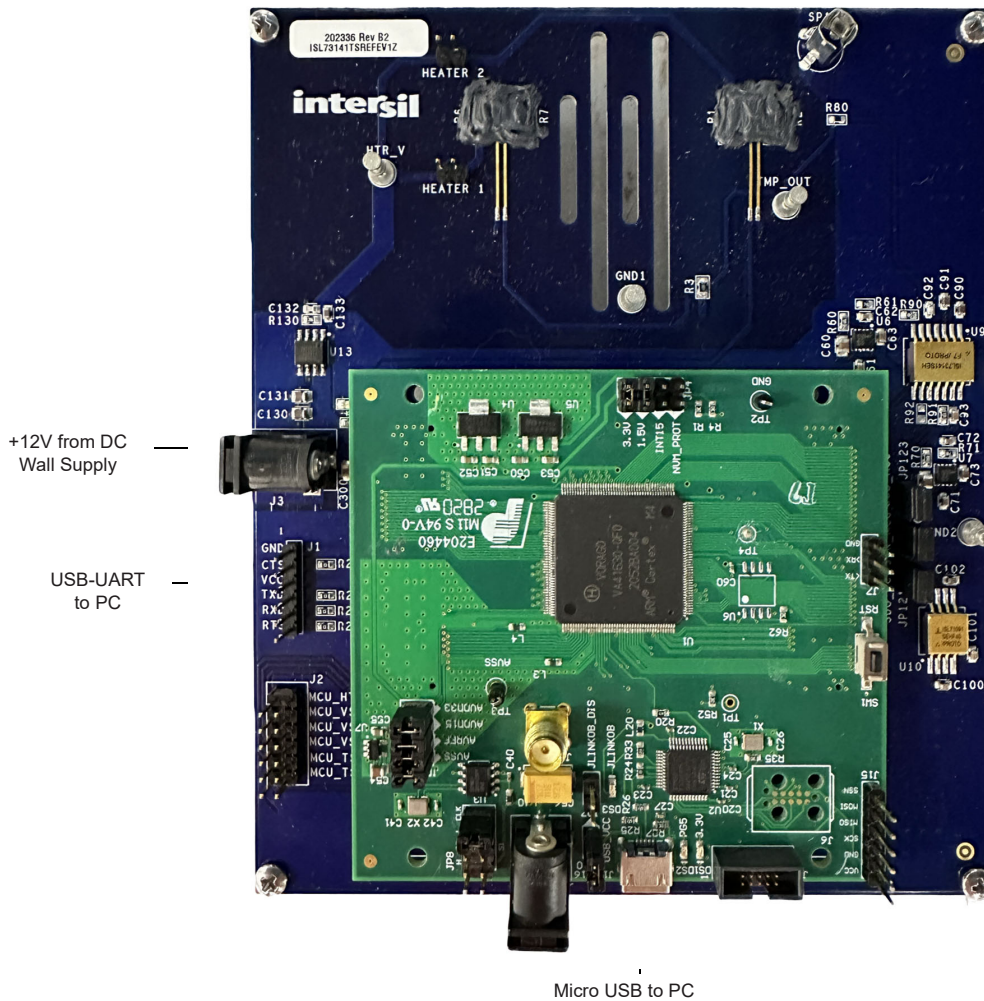

Figure 7. ISL73141TSREFEV1Z/VA41620 Connection Diagram

1.2.1 iRADNavigator Board Selection

Double click on the **iRADNavigator** icon from the desktop on the PC to open the **iRADNavigator** software. In the **Available Hardware** box click to expand the list of ADC Reference designs list. Select *ISL73141_Temp_Sensor* from the list and then click the **Select** button.

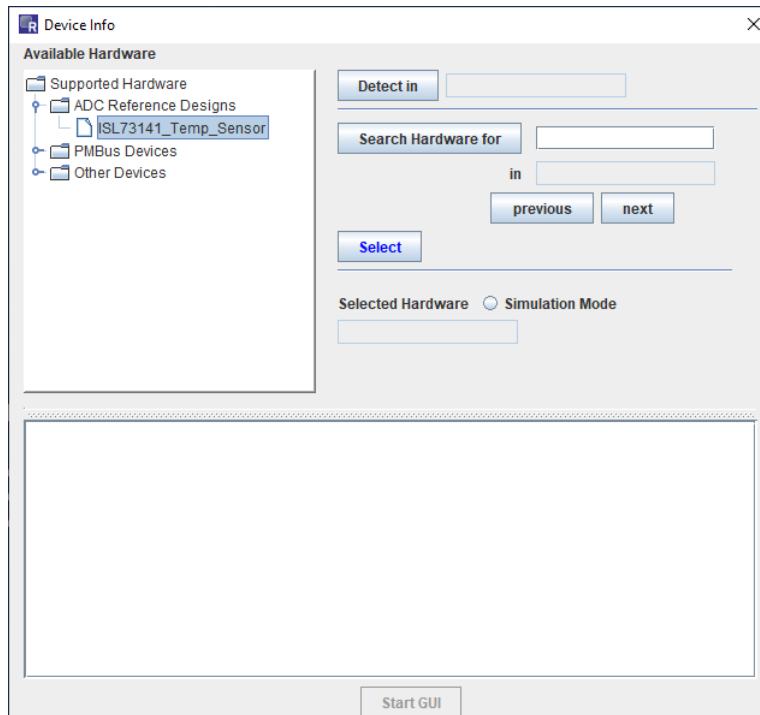

Figure 8. iRADNavigator Board Selection

After clicking **Select**, the GUI loads the screen shown in [Figure 9](#), which shows the ISL73141 Temp Sensor board is selected and the available board communication options. Click **Connect** to connect the GUI to the board.

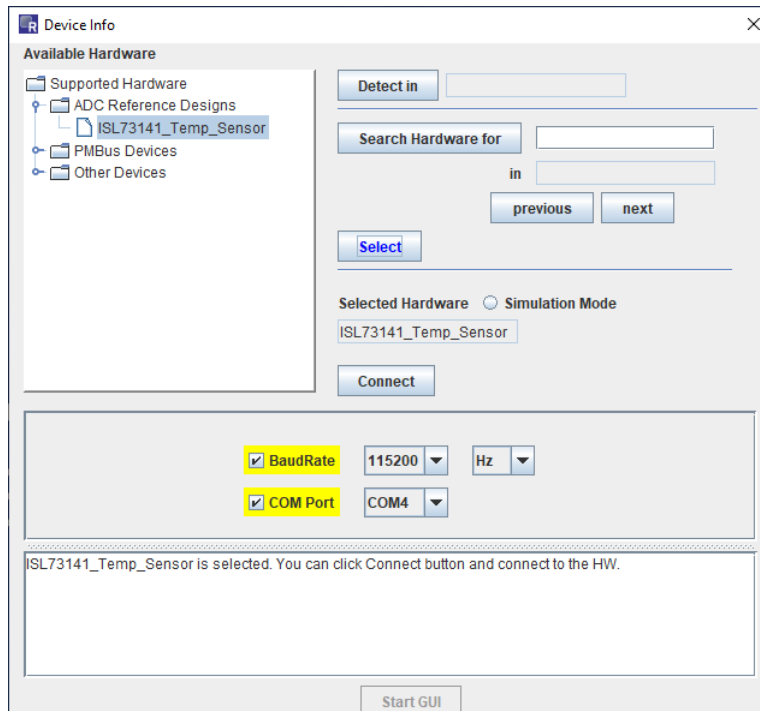

Figure 9. iRADNavigator Board Selection and Communication Options

After clicking the **Connect** button, iRADNavigator communicates with the Vorago MCU board to ensure the latest firmware is loaded into the Vorago MCU. If not, a pop-up window opens prompting the update of the firmware. If the Vorago MCU firmware is up to date, this pop-up window does not open.

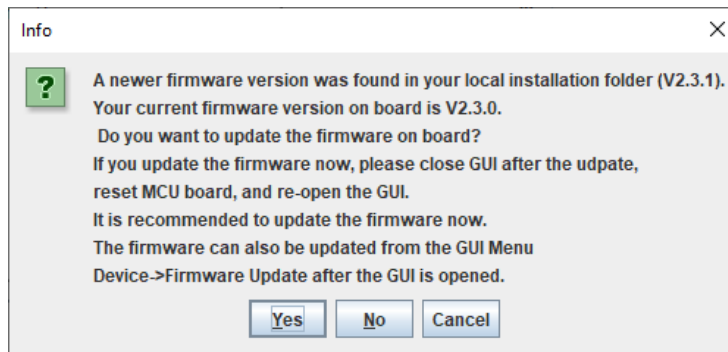

Figure 10. iRADNavigator Firmware Update Prompt

When the firmware update is complete, another pop-up window opens to state that the Vorago MCU firmware has been updated. Click **OK** to acknowledge the firmware update.

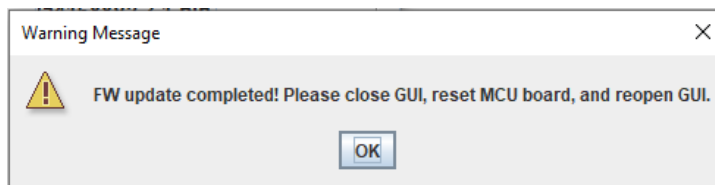

Figure 11. iRADNavigator Firmware Update Complete

After clicking **OK**, close iRADNavigator, press the reset button on the Vorago MCU board, and reopen the GUI. Select the ISL73141_Temp_Sensor from the selection tree and click **Connect**.

When communication is established to the ISL73141 Temp Sensor board, the **Start GUI** button illuminates. Click the **Start GUI** button to proceed.

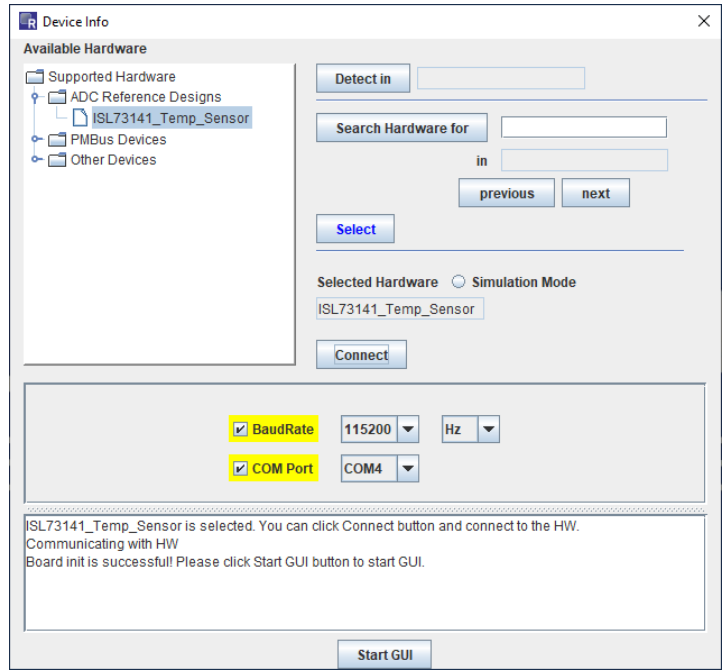

Figure 12. iRADNavigator Start GUI

1.2.2 iRADNavigator Temp Sensor Calibration

When the **Start GUI** button is clicked, the GUI window changes, allowing temperature calibration for the ISL73141 Temp Sensor board. This step is extremely important so that temperature measurements made by the board are accurate. The board should be configured as instructed in the GUI with no jumpers on HEATER 1 (JP1) and HEATER 2 (JP10) so that no voltage is applied to the heating resistors on the board. During calibration, both sensors should also be at the same temperature. Ensure that HEATER 1 (JP1) and HEATER 2 (JP10) are not populated on the board and that the boxes for Jumper 1 and Jumper 10 are checked. Click **Execute** to perform the temperature calibration.

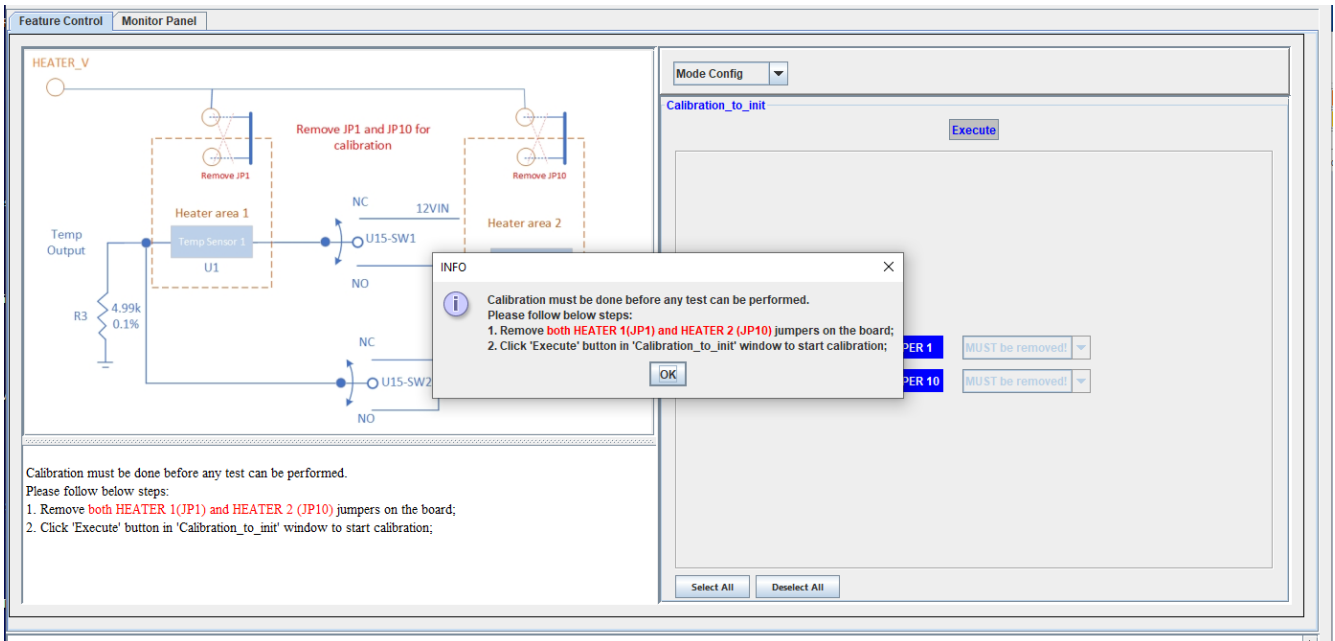

Figure 13. iRADNavigator Board Temperature Calibration Configuration

When calibration is complete, a window indicates that the calibration is successful. Click the **OK** button to proceed with configuring the required measurement.

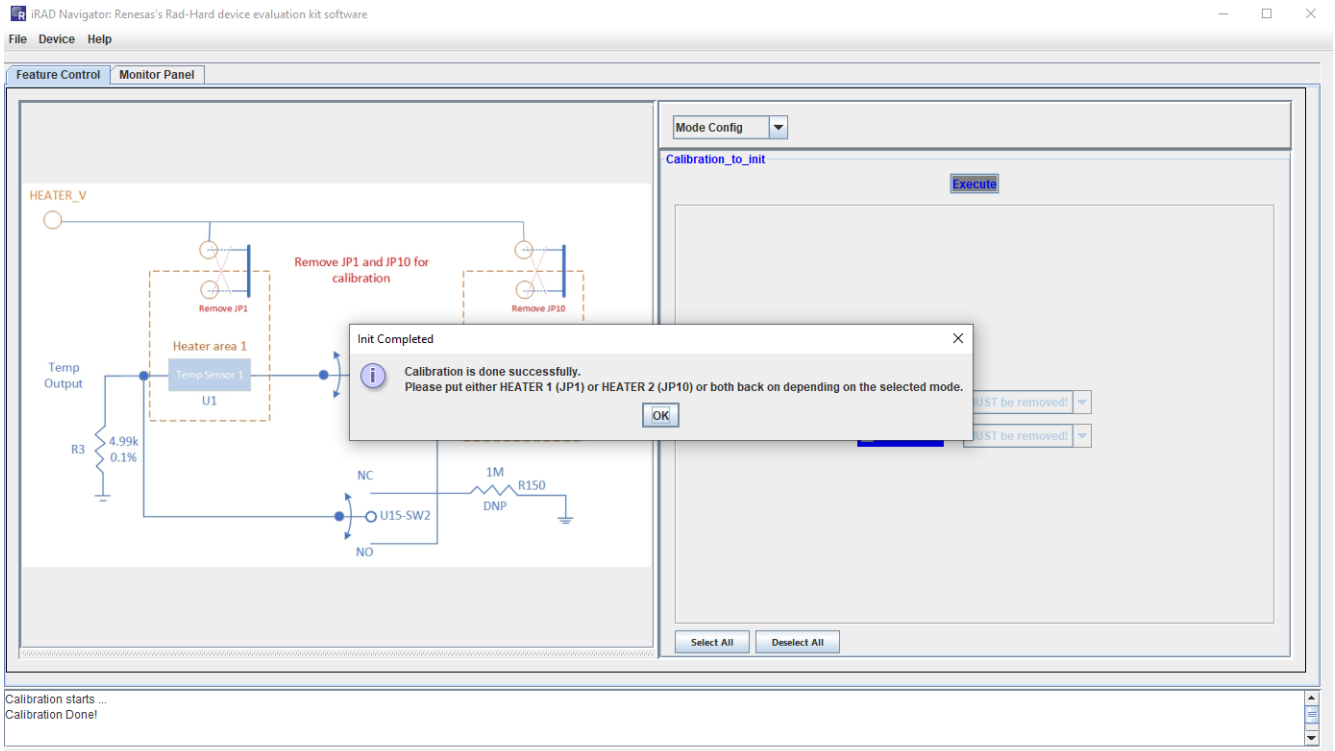

Figure 14. iRADNavigator Temperature Calibration Complete

The GUI updates to show available measurements that can be configured and added to the Monitor.

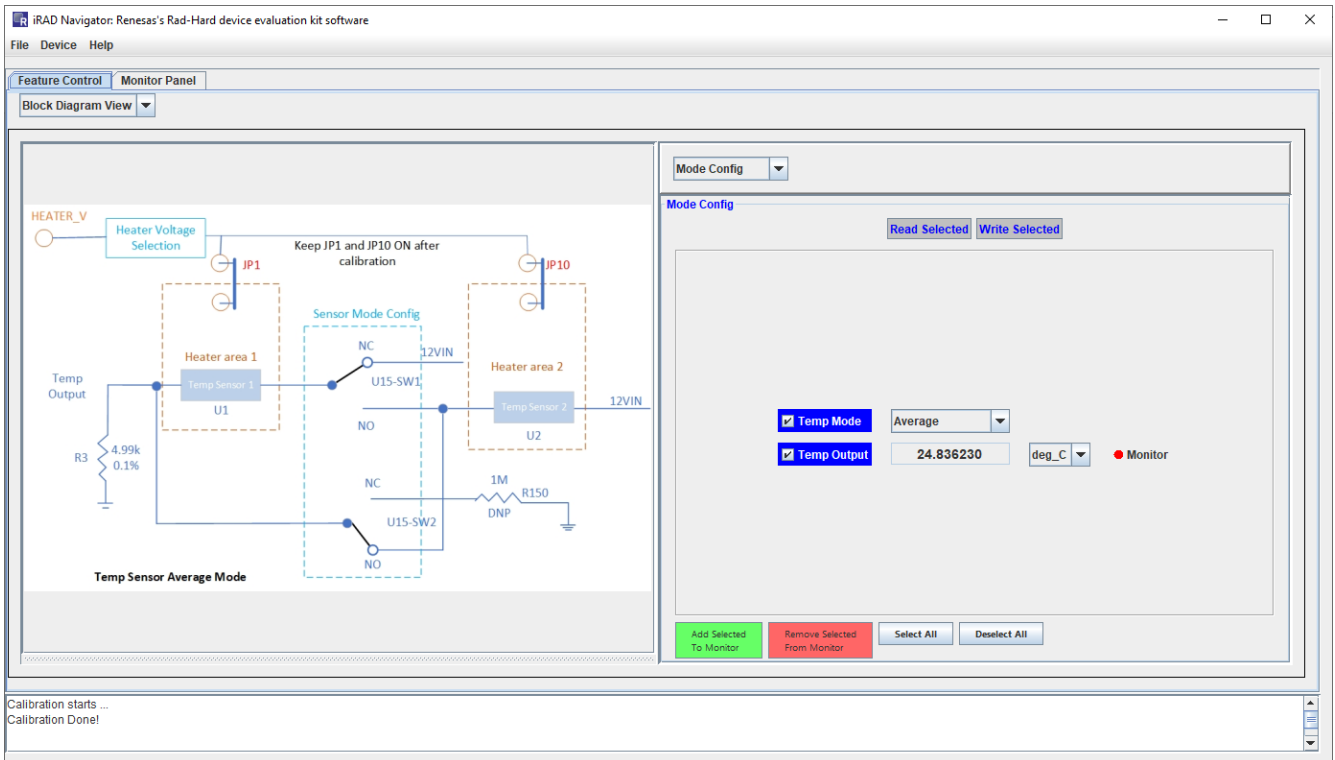

Figure 15. iRADNavigator Available Temperature Measurements

1.2.3 iRADNavigator Temperature Measurements

In this example, the single temperature sensor measurement is looked at, which is selected by default. When the calibration is complete, the next step is adding the measurement to the monitor by clicking the green button in the GUI labeled **Add Selected To Monitor**. When the measurement is added to the monitor, click on the Monitor Panel tab to view the monitoring options. To see only text output, click **Start Monitor** and the text box in the middle of the screen periodically updates with the current temperature value. In this example, the current temperature is plotted. To plot this, click on the green button **Add Plot**. The dot beside **Plot** in the middle of the screen should illuminate green when the measurement is ready to plot. It illuminates red if there is nothing selected for plotting. Click **Start Monitor** to begin plotting the temperature measurement.

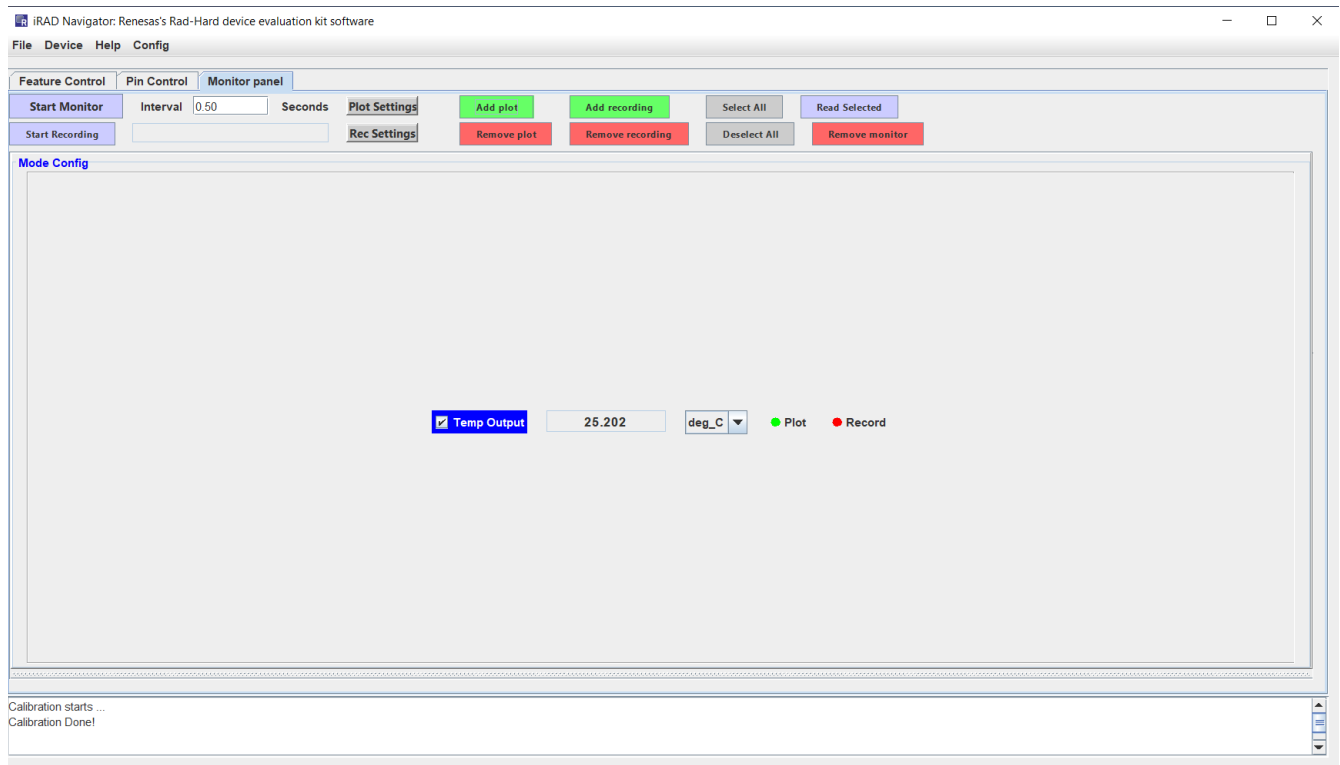

Figure 16. iRADNavigator Monitor Panel Options

Click **Start Monitor** to begin plotting the temperature measurement. A separate window appears, and the selected temperature measurement plotting begins.

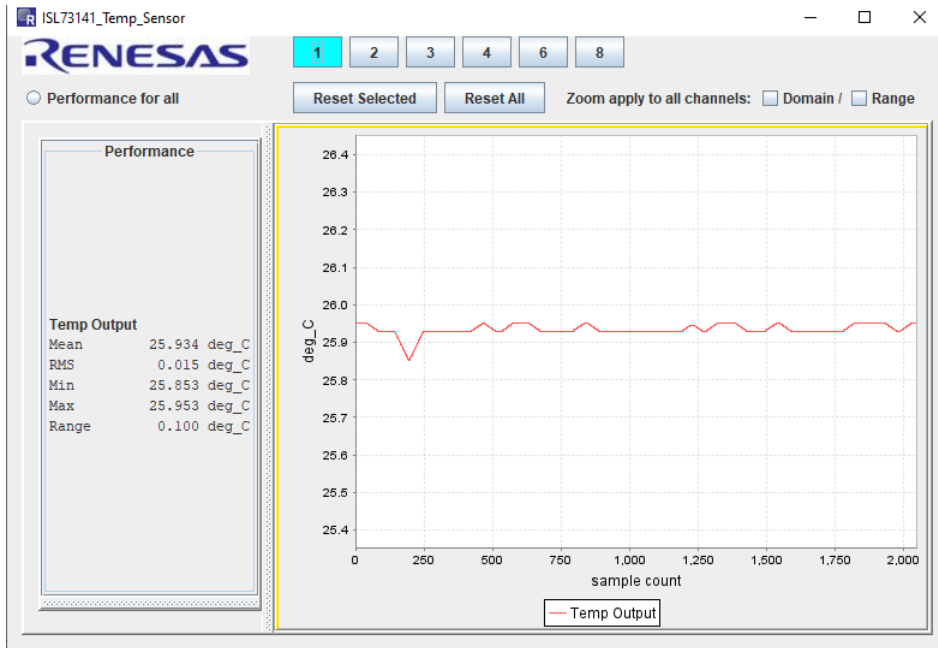

Figure 17. iRADNavigator Temperature Measurement Plot

In this example, the room temperature is 27°C, so the plot shows a measurement of this value. Use freeze spray to cool off the sensor to see a temperature change. In the plot shown in Figure 18, two bursts of freeze spray are applied to the leftmost temperature sensor U1. Two distinct drops in temperature followed by a slow rise as the temperature sensor begins to return to room temperature are shown. Alternatively, use the heater resistors to change the temperature. This option is discussed in the next section.

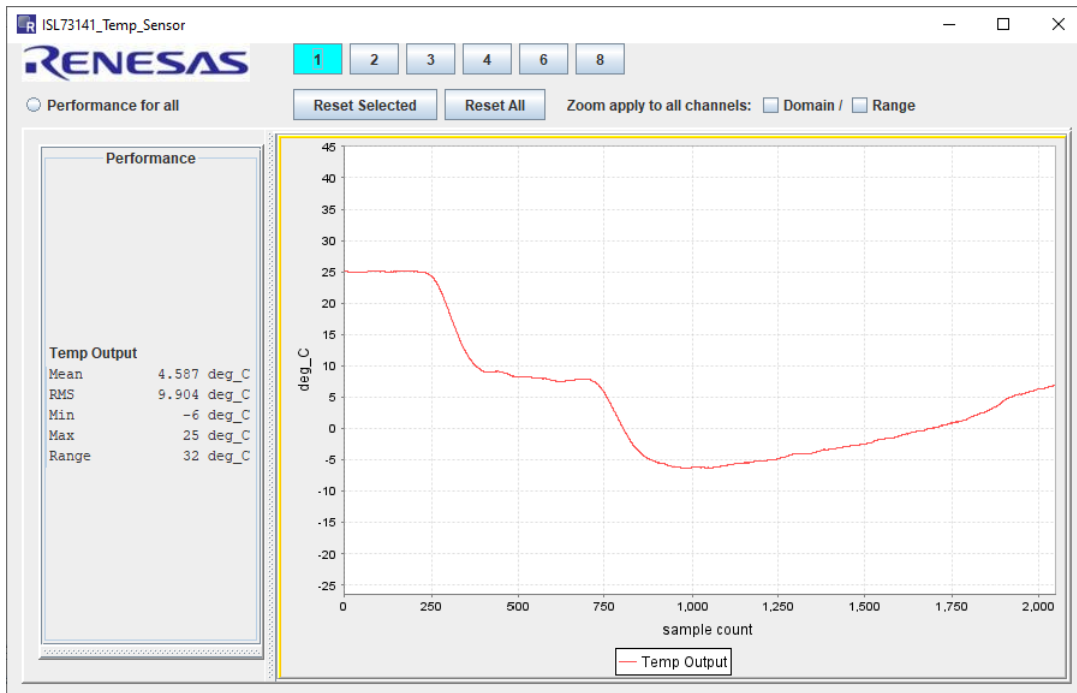

Figure 18. iRADNavigator Temperature Change Measurement Plot

1.2.4 iRADNavigator Feature Control

The ISL73141SEH Temp Sensor board has heater resistors that can heat the temperature sensors on the board. Under the **Feature Control** tab, click on drop-down menu in the right half of the window and then click on **Heater Select**, as shown in Figure 19. This allows the voltage selection to be applied to the heater resistors. Jumpers HEATER 1 (JP1) and HEATER 2 (JP10) connect this voltage to temperature sensors U1 (left) and U2 (right). Connect the appropriate jumper for the voltage to be applied to the heater resistor to heat the required temperature sensor. In this example, HEATER 1 (JP1) is populated to provide voltage to the heater resistor for temperature sensor U1 on the left.

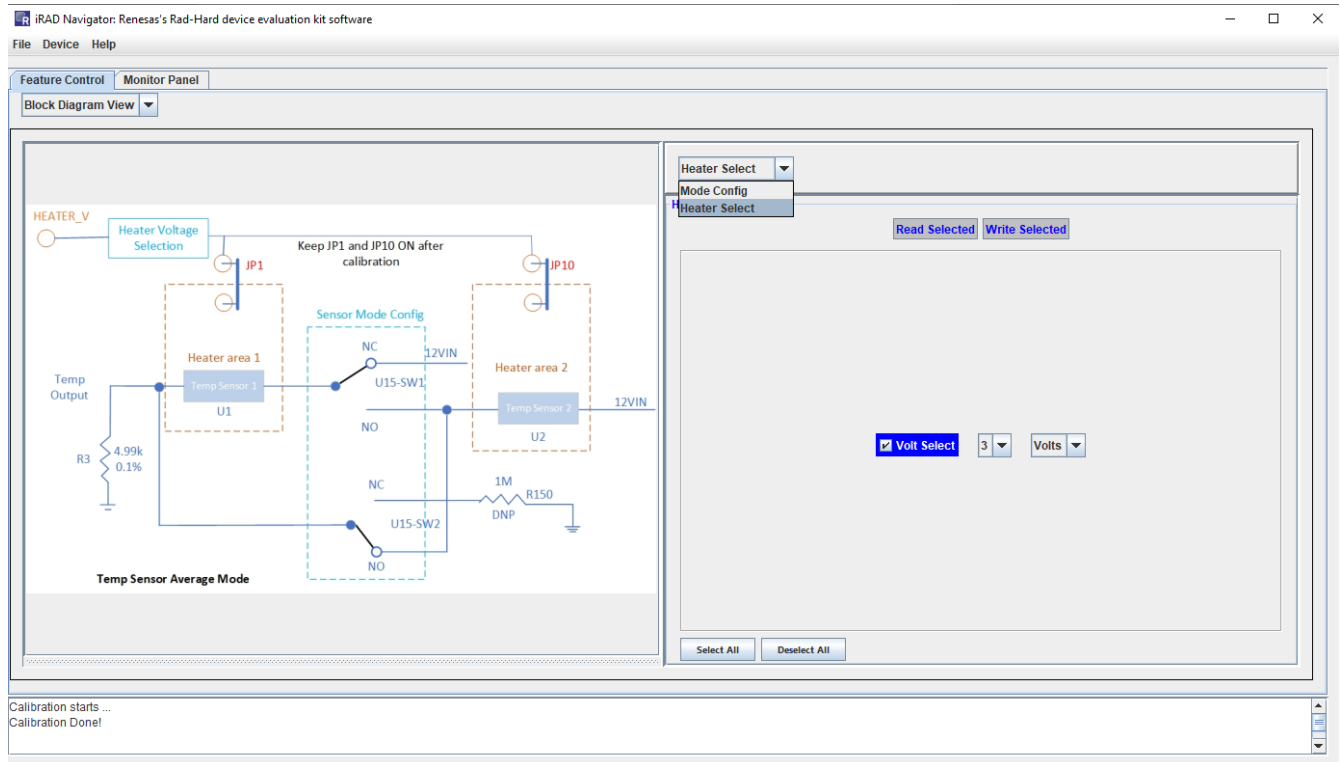

Figure 19. iRADNavigator Function Selection

There are four different voltage selections that can be used to heat the temperature sensor. The higher the voltage the more the heater resistor heats the temperature sensor. Voltage values of 3V, 5V, 7V, and 9V are available.

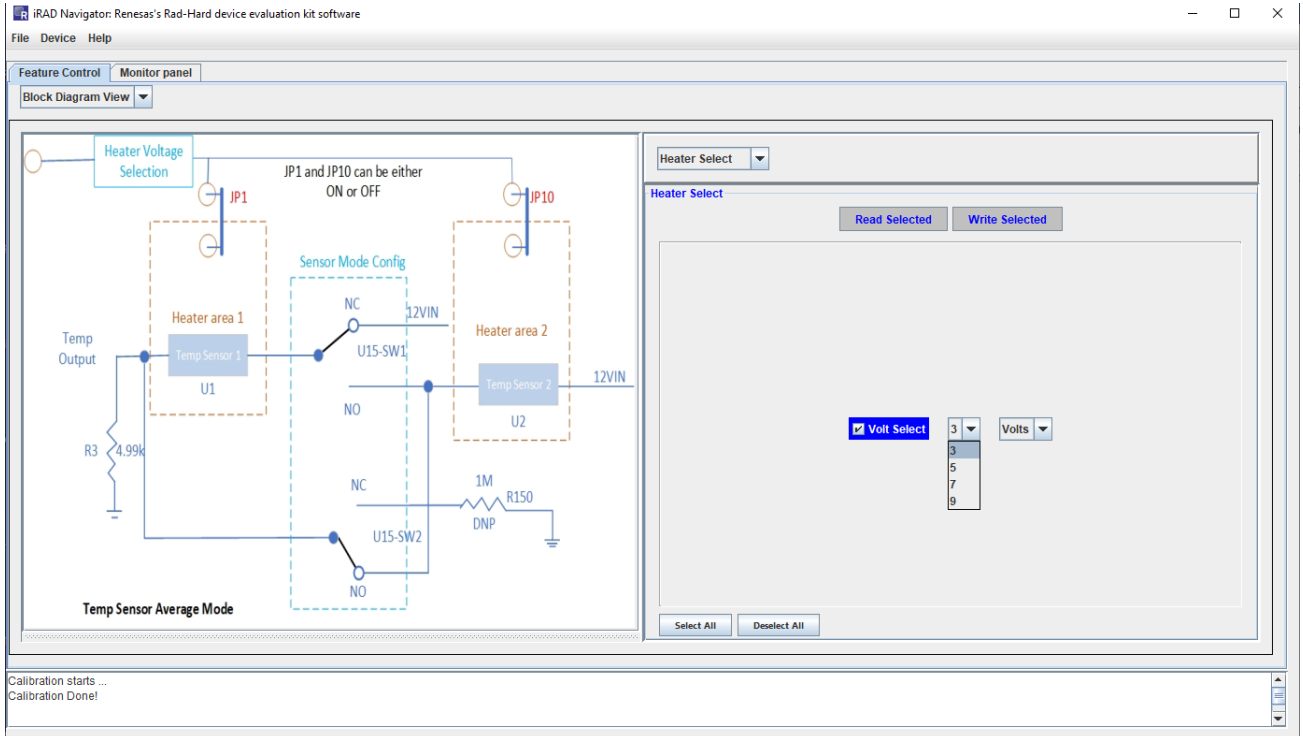

Figure 20. iRADNavigator Heater Voltage Selection

With the heater selection voltage set to 3V, the average temperature when the sensor is fully heated should be approximately 29°C. Heater voltages of 5V, 7V, and 9V result in approximate temperatures of 32.5°C, 38°C, and 45°C, respectively.

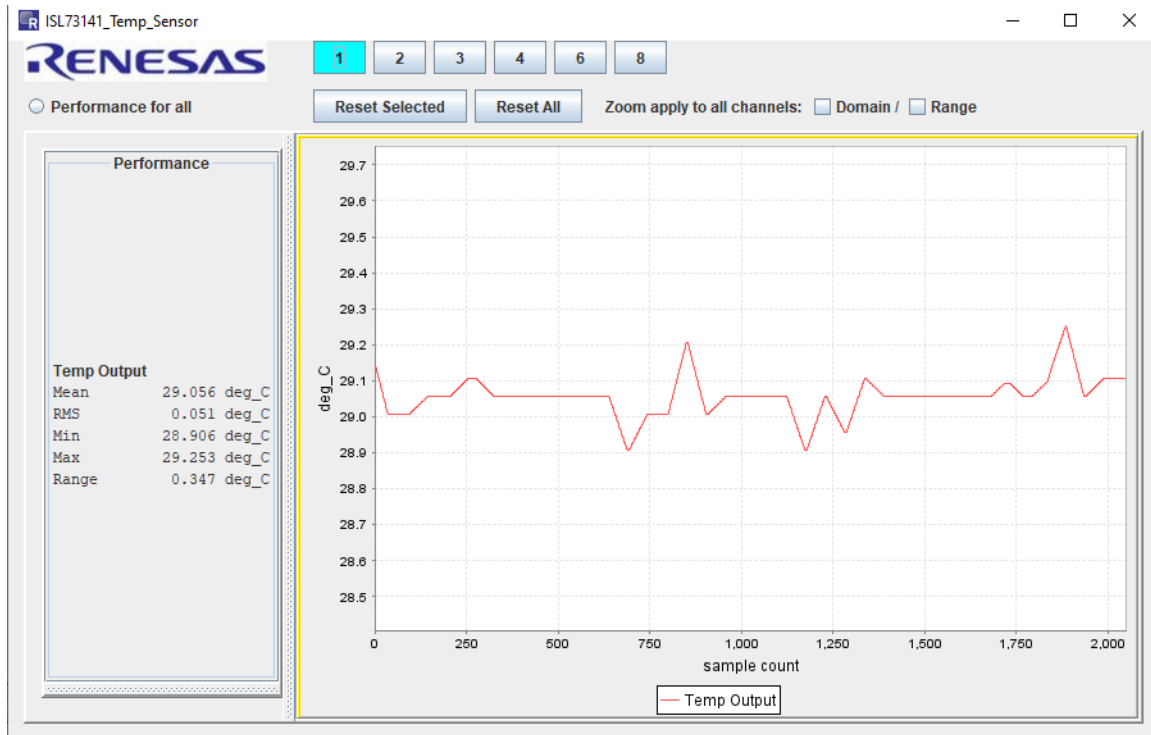

Figure 21. iRADNavigator Temperature with 3V Heater Voltage

The plot window has several user-controlled settings. The sampling mode can be continuous or single. Adjustments include the plot window size (default nearest 2^N samples), the top margin and bottom margin around the measured value (default 20), time and/or sample limit, and the sample rate (100sps recommended).

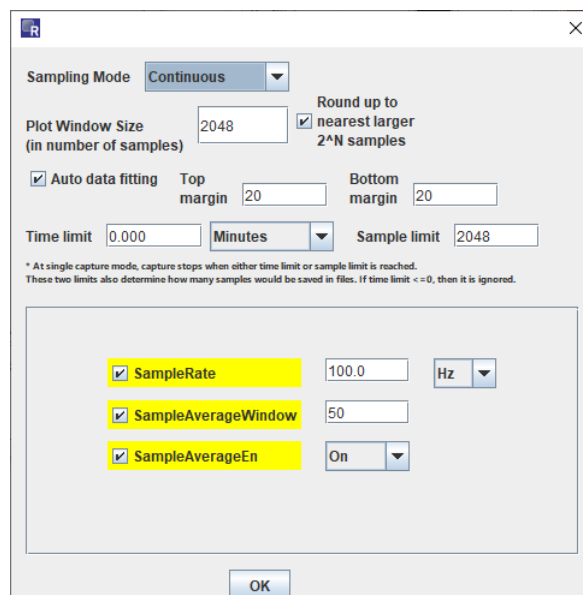

Figure 22. iRADNavigator Plot Settings

1.2.5 iRADNavigator Temperature Sensor Configurations

The examples previously mentioned have focused on operating in Single mode and performing single sensor measurements, which use sensor U1 on the left exclusively. iRADNavigator can also be configured to operate the two temperature sensors together in either the lowest or average mode.

The two temperature sensors are configured in series when operating in Lowest mode. In this configuration, the temperature sensor with the lowest temperature dominates the series current flowing through the load resistor R_{80} , resulting in the measurement result giving the lowest temperature of the two temperature sensors.

The two temperature sensors are configured in parallel when operating in Average mode. In this configuration, the two temperature sensors are connected in parallel, resulting in their current summing and flowing through the load resistor R80. In this case, iRADNavigator reads the output value and performs an average calculation to determine the average temperature of the two temperature sensors.

In the same way that the Single measurements were adjusted, the Lowest and Average measurements can be added to the monitor and displayed as values or in a plot window. Select only one measurement type at a time.

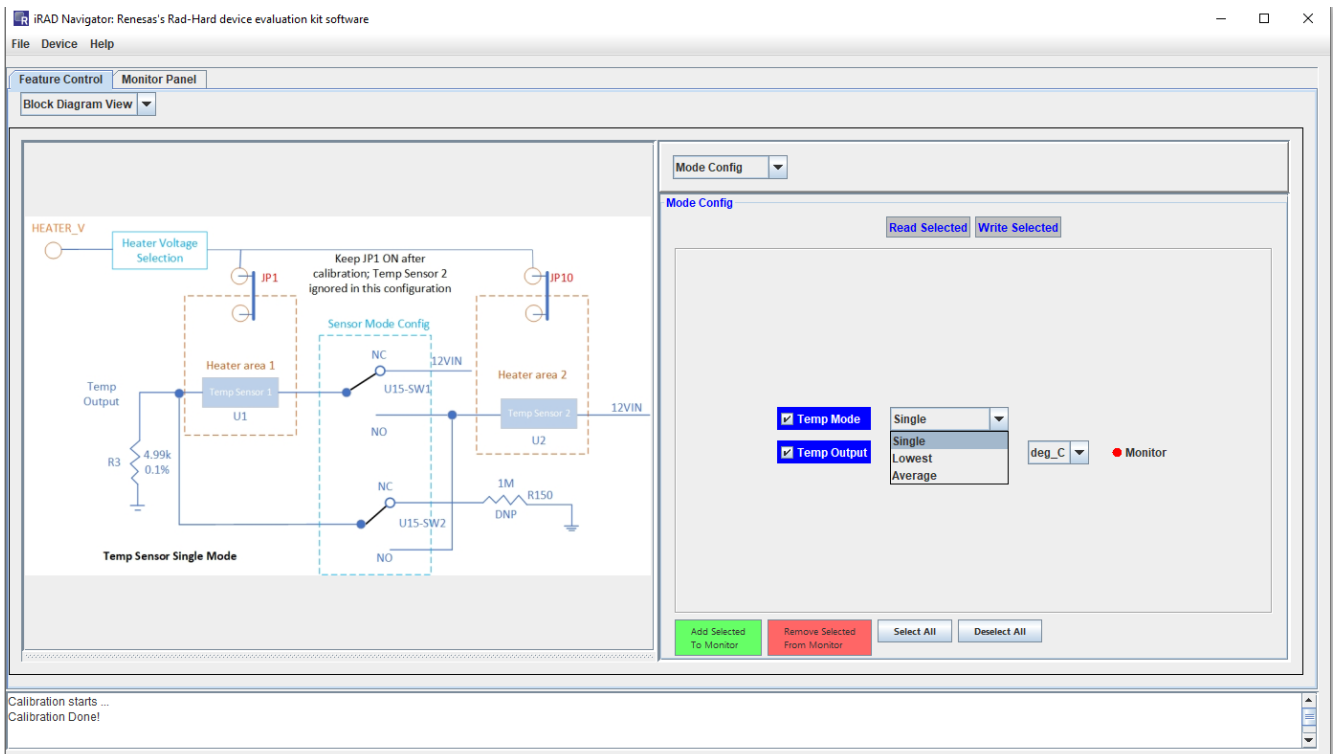

Figure 23. iRADNavigator Temperature Sensor Configurations

1.3 iRADNavigator MCU Firmware Update

The Vorago MCU firmware can be updated from within the iRADNavigator software GUI to ensure that the latest firmware is present in the MCU. To perform an update, select **Device** then **Firmware Update** from the menu bar.

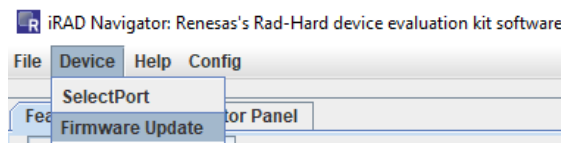

Figure 24. iRADNavigator MCU Firmware Update Selection

A pop-up window opens, which allows reading the current firmware version, performing an online update, or performing a local update. The latest firmware should be installed along with the most recent iRADNavigator installation, but an online update might be required to have the most recent version of MCU firmware.

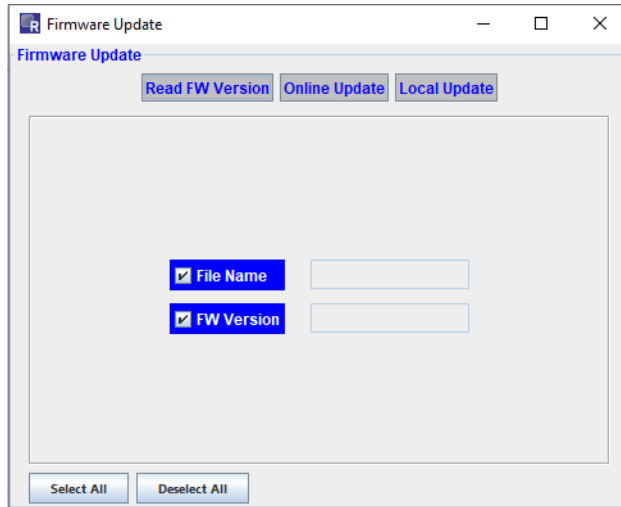

Figure 25. iRADNavigator MCU Firmware Update Action Window

If performing an online update, the GUI looks for the latest MCU firmware on the Renesas website when **Online Update** is selected. Renesas recommends using the online update; however, the firmware can be downloaded from the Renesas website and stored locally and then a local update can be performed. After selecting **Online Update**, the GUI searches for the latest firmware on the Renesas website and reports back the latest version found as shown in [Figure 26](#). Click **Yes** to proceed with updating the firmware.



Figure 26. iRADNavigator MCU Firmware Online Update

Click Yes to update the firmware. After the firmware is downloaded, a GUI prompt opens in a pop-up window to confirm programming the new firmware into the board. Click **Yes** again to program the firmware.



Figure 27. iRADNavigator MCU Firmware Online Update - Program Firmware

After the firmware is programmed into the board, the GUI prompts that it is complete. Click **OK** and then close the GUI, reset the MCU board, and then reopen the GUI.



Figure 28. iRADNavigator MCU Firmware Online Update - Program Firmware

When selecting Local Update, point iRADNavigator to the installation folder to find the firmware or to the folder where the firmware is stored if it was downloaded previously from the Renesas website. Figure 29 shows the typical installation path.

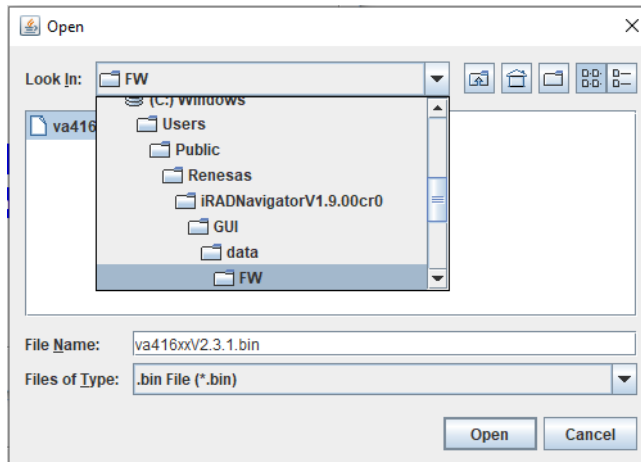

Figure 29. iRADNavigator MCU Firmware Location on Local Computer

Select the latest firmware in this location and click **Open**. Figure 30 shows the next prompt to confirm that programming the selected firmware into the MCU is required.



Figure 30. iRADNavigator MCU Firmware Confirmation

When the MCU firmware is installed into the MCU, the window in Figure 31 opens to alert that the installation is complete. Click **OK** and then close iRADNavigator. Press the reset button on the Vorago MCU board and reopen iRADNavigator.



Figure 31. iRADNavigator MCU Firmware Update Complete

2. Board Design

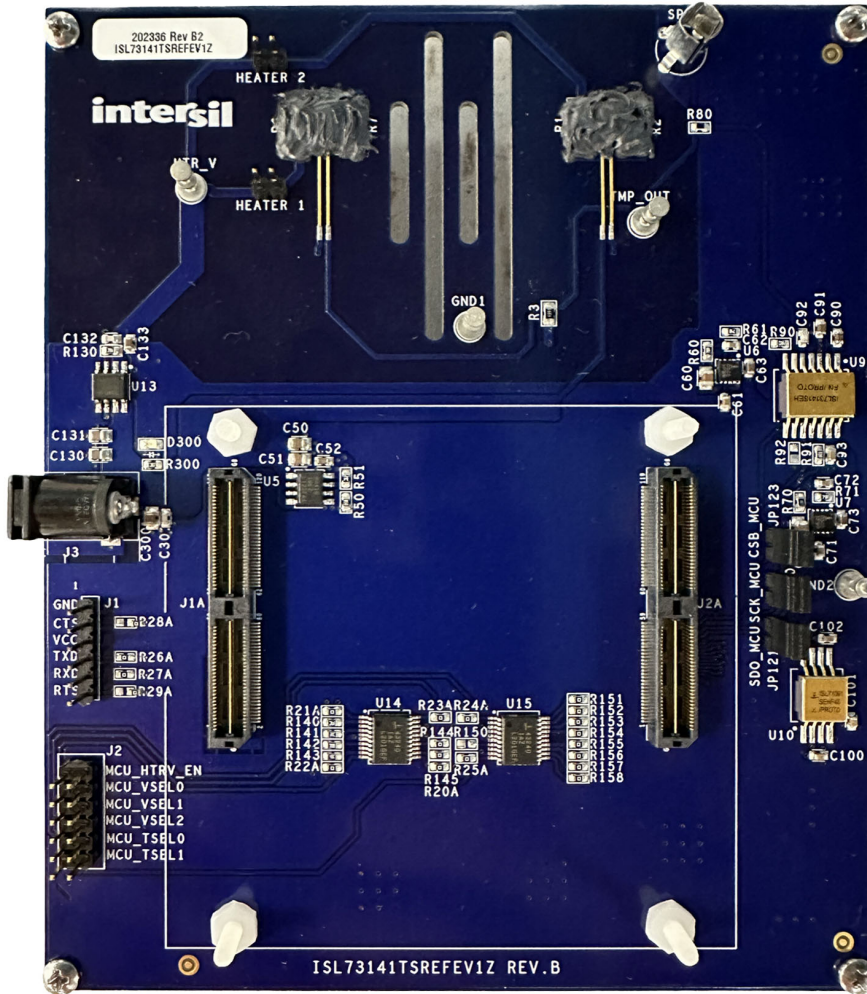

Figure 32. ISL73141TSREFEV1Z Evaluation Board (Top)

2.1 Schematics

POWER SUPPLY AND VREF CIRCUITRY

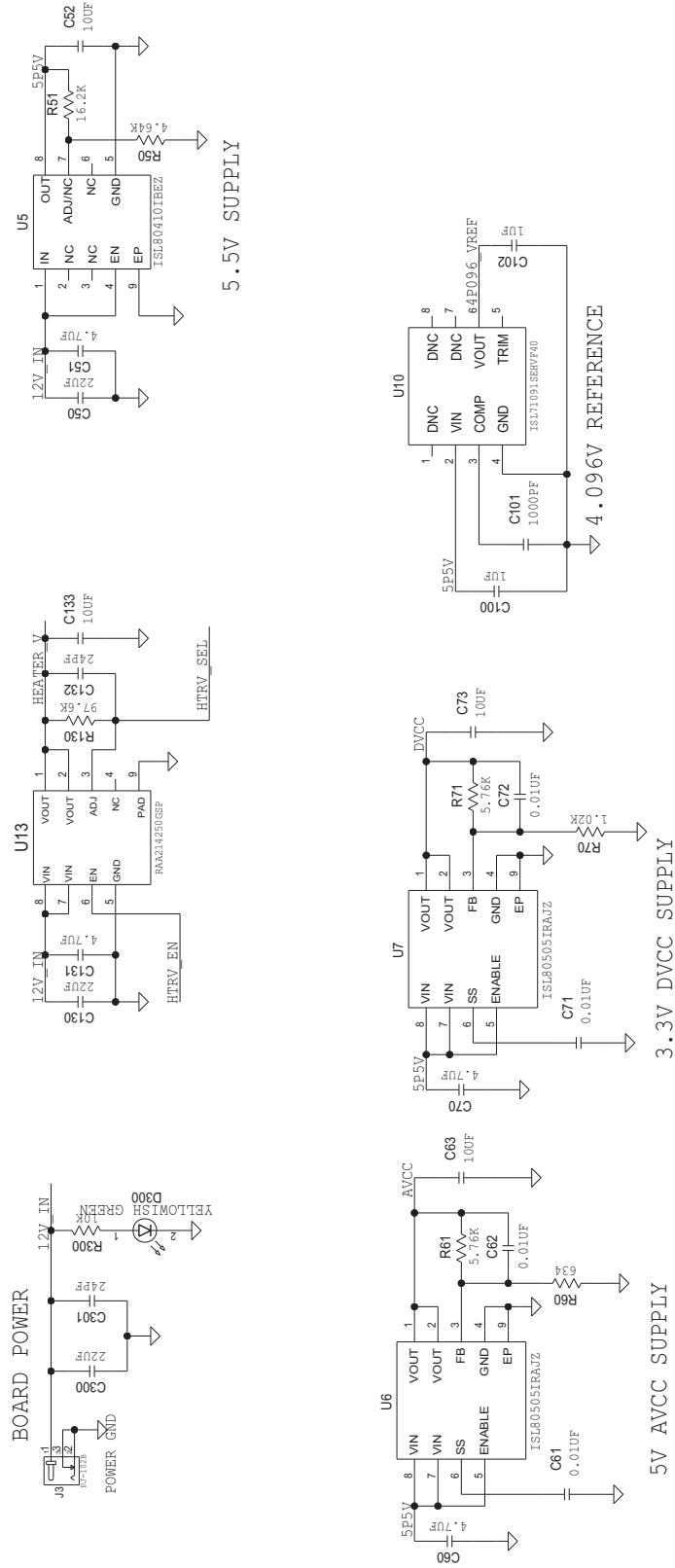

Figure 33. Power Supply and VREF Circuitry

CONFIGURATION CIRCUITRY

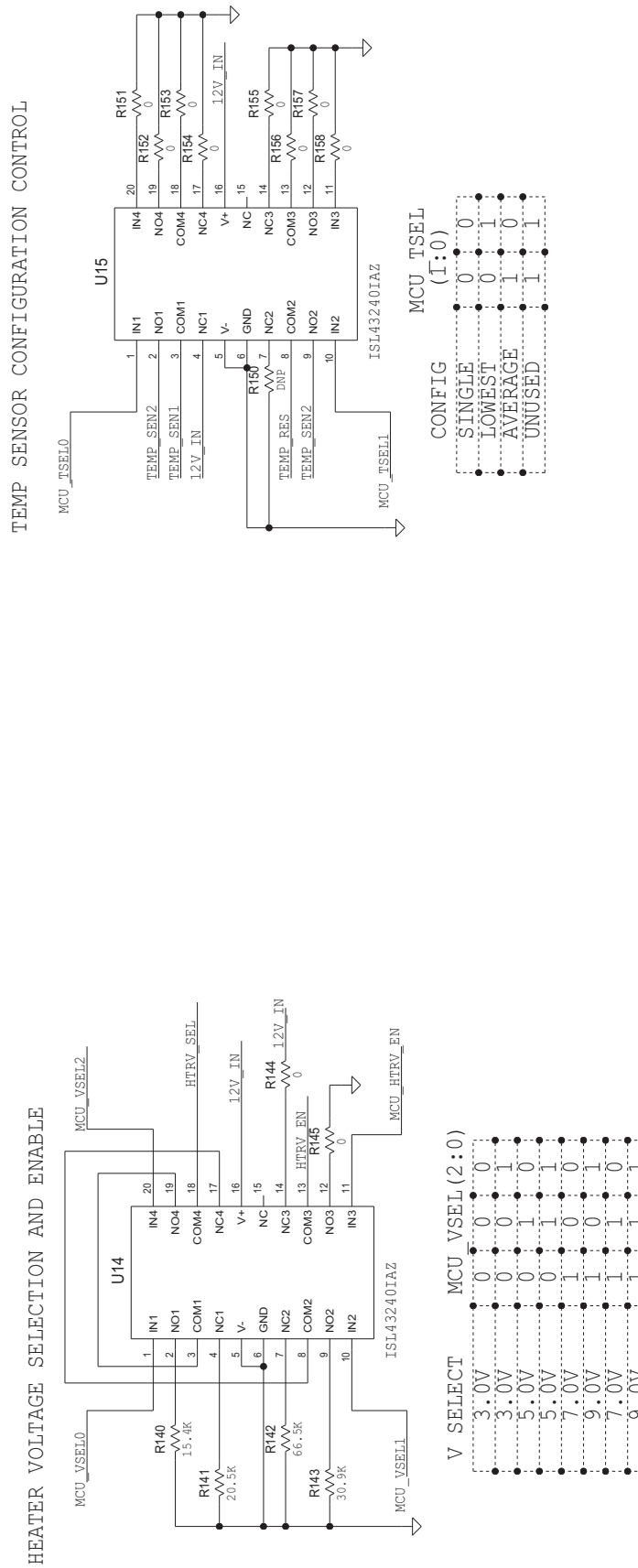

Figure 35. Configuration Circuitry

BOARD CONNECTORS

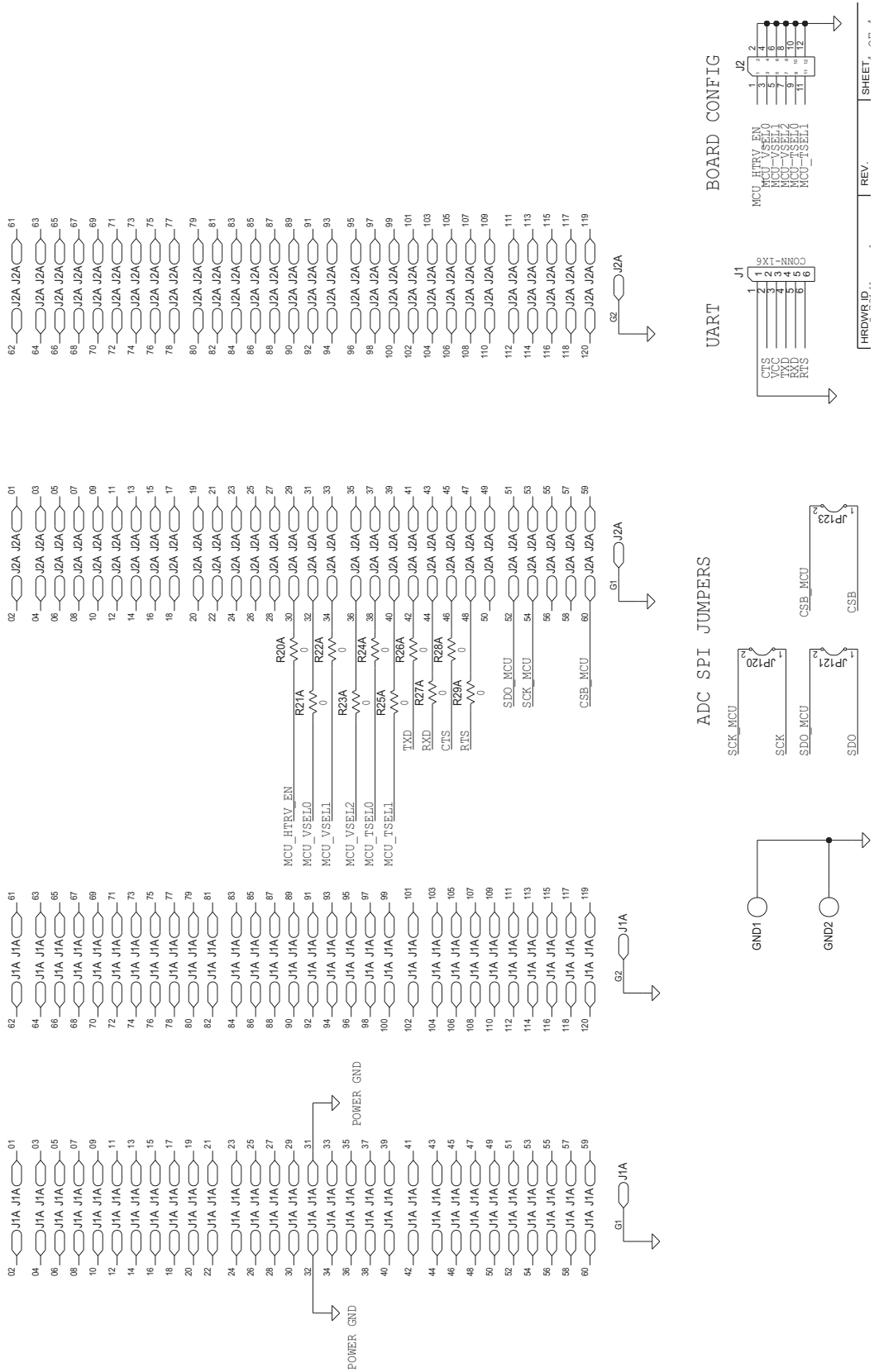

Figure 36. Board Connectors

2.2 Bill of Materials

Qty	Reference Designator	Description	Manufacturer	Manufacturer Part
1	-	PWB-PCB, ISL73141TSREFEV1Z, REVA, ROHS	Imagineering Inc	ISL73141TSREFEV1ZREVBPCB
1	C101	CAP, SMD, 0603, 1000pF, 16V, 10%, X7R, ROHS	Kyocera/AVX	0603YC102KAT2A-T
1	C93	CAP, SMD, 0603, 0.1µF, 50V, 10%, X7R, ROHS	TDK	C1608X7R1H104K-T
1	C92	CAP, SMD, 0603, 470pF, 50V, 5%, COG/NP0, ROHS	Yageo	CC0603JRNPO9BN471-T
4	C61, C62, C71, C72	CAP-AEC-Q200, SMD, 0603, 0.01µF, 50V, 10%, X7R, ROHS	TDK	CGA3E2X7R1H103K080AA-T
4	C51, C60, C70, C131	CAP-AEC-Q200, SMD, 0805, 4.7µF, 25V, 10%, X7R, ROHS	TDK	CGA4J1X7R1E475K125AC-T
2	C100, C102	CAP-AEC-Q200, SMD, 0603, 1µF, 25V, 10%, X7R, ROHS	Murata	GCJ188R71E105KA01D-T
2	C132, C301	CAP, SMD, 0603, 24pF, 50V, 5%, COG/NP0, ROHS	Murata	GRM1885C1H240JA01D-T
6	C52, C63, C73, C90, C91, C133	CAP, SMD, 0603, 10µF, 16V, 20%, X5R, ROHS	Murata	GRM188R61C106MA73D-T
3	C50, C130, C300	CAP-AEC-Q200, SMD, 0805, 22µF, 25V, 20%, X5R, ROHS	Murata	GRT21BR61E226ME13L-T
0	R92	CAP, SMD, 0603, DNP-PLACE HOLDER, ROHS	-	-
1	SP1	CONN-SCOPE PROBE TEST PT, COMPACT, ROHS	Tektronix	131-4353-00
4	GND1, GND2, HTR_V, TMP_OUT	CONN-TURRET, TERMINAL POST, TH, ROHS	Keystone Electronics	1514-2
1	J2	CONN-HEADER, 2×6, BRKAWY-2×36, 2.54mm, ROHS	Amphenol	67996-272HLF-2X6
1	J1	CONN-HEADER, 1×6, BRKAWY 1×36, 2.54mm, ROHS	Amphenol	68000-236HLF-1X6
5	JP1, JP10, JP120, JP121, JP123	CONN-HEADER, 1×2, RETENTIVE, 2.54mm, ROHS	Amphenol	69190-202HLF
1	J3	CONN-2.5A PWR JACK, TH, 2.5×5.5mm, R/A, BLK, ROHS	CUI Devices	PJ-102B
1	D300	LED, SMD, 0805, GREEN/CLEAR, 2.2V, 20mA, 25MCD, ROHS	Rohm Semiconductor	SML-H12M8TT86-T
2	U14, U15	IC-QUAD SPDT ANALOG SWITCH, 20P, SSOP, ROHS	Renesas	ISL43240IAZ

ISL73141TSREFEVKIT1Z Evaluation Kit Manual

Qty	Reference Designator	Description	Manufacturer	Manufacturer Part
1	U10	IC-4.096V RH PREC.VOLT.REFERENCE, 8P, CFP, ROHS	Renesas	ISL71091SEHF40/PROTO
2	U1, U2 *SEE DOCUMENT #1	IC-TEMPERATURE TRANSDUCER, 2P, FLATPACK, ROHS	Renesas	ISL71590SEHF/PROTO
1	U9	IC-5V RAD HARD, 14-BIT, ADC, 14P, CDFP, ROHS	Renesas	ISL73141SEHF7/PROTO
1	U5	IC-40V, 150mA LDO REGULATOR, 8P, EPSONIC, ROHS	Renesas	ISL80410IBEZ
2	U6, U7	IC-SINGLE 500mA, ADJ., LDO, 3x3, 8P, DFN, ROHS	Renesas	ISL80505IRAJZ
1	U13	IC-20V, 500mA LDO REGULATOR, 8P, SOIC, ROHS	Renesas	RAA2142504GSP#HA0
1	R80	RES-AEC-Q200, SMD, 0603, 22Ω, 1/10W, 1%, TF, ROHS	Vishay/Dale	CRCW060322R0FKEA-T
4	R1, R2, R6, R7 *SEE DOCUMENT #1	RES, SMD, 2512, 200Ω, 1W, 5%, TF, ROHS	Panasonic	ERJ-1TYJ201U-T
0	R150	RESISTOR, SMD, 0603, 0.1%, MF, DNP-PLACE HOLDER	-	-
1	R300	RES, SMD, 0603, 10K, 1/10W, 1%, TF, ROHS	Yageo	RC0603FR-0710KL-T
1	R140	RES, SMD, 0603, 15.4K, 1/10W, 1%, TF, ROHS	Yageo	RC0603FR-0715K4L-T
1	R51	RES, SMD, 0603, 16.2K, 1/10W, 1%, TF, ROHS	Yageo	RC0603FR-0716K2L-T
1	R70	RES, SMD, 0603, 1.02K, 1/10W, 1%, TF, ROHS	Yageo	RC0603FR-071K02L-T
1	R90	RES, SMD, 0603, 1K, 1/10W, 1%, TF, ROHS	Yageo	RC0603FR-071KL-T
1	R141	RES, SMD, 0603, 20.5K, 1/10W, 1%, TF, ROHS	Yageo	RC0603FR-0720K5L-T
1	R143	RES, SMD, 0603, 30.9K, 1/10W, 1%, TF, ROHS	Yageo	RC0603FR-0730K9L-T
1	R91	RES, SMD, 0603, 33Ω, 1/10W, 1%, TF, ROHS	Yageo	RC0603FR-0733RL-T
1	R50	RES, SMD, 0603, 4.64K, 1/10W, 1%, TF, ROHS	Yageo	RC0603FR-074K64L-T
2	R61, R71	RES, SMD, 0603, 5.76K, 1/10W, 1%, TF, ROHS	Yageo	RC0603FR-075K76L-T
1	R60	RES, SMD, 0603, 634Ω, 1/10W, 1%, TF, ROHS	Yageo	RC0603FR-07634RL-T

Qty	Reference Designator	Description	Manufacturer	Manufacturer Part
1	R142	RES, SMD, 0603, 66.5K, 1/10W, 1%, TF, ROHS	Yageo	RC0603FR-0766K5L-T
1	R130	RES, SMD, 0603, 97.6K, 1/10W, 1%, TF, ROHS	Yageo	RC0603FR-0797K6L-T
20	R20A-R29A, R144, R145, R151-R158	RES, SMD, 0603, 0Ω, 1/10W, TF, ROHS	Yageo	RC0603JR-070RL-T
1	R3	RES-AEC-Q200, SMD, 0805, 4.99K, 1/8W, 0.1%, THINFILM, ROHS	Susumu	RG2012P-4991-B-T5
4	Four corners top PCB	SCREW, 4-40×1/4in, PHILLIPS, PANHEAD, SS, ROHS	Building Fasteners	4-40X1/4-SCREW-SS
4	Four corners bottom PCB	STANDOFF, 4-40×5/8in, F/F, HEX, ALUMINUM, ROHS	McMaster-Carr	4-40X5/8-STANDOFF-ALUM
5	JP1, JP10, JP120, JP121, JP123	CONN-JUMPER, SHUNT, 2P, 2.54mm PITCH, BLK, 6mm, OPEN, ROHS	Sullins	SPC02SYAN
2	U1, U2, R1, R2, R6, R7 *See Document #1	ADHESIVE, 2-PART EPOXY, HIGH THERMAL, 4 HOUR CURE,	MG Chemicals	8329TCS
2	J1A, J2A	CONN-HEADER, GND PLANE TERMINAL STRIP, SMD120P, ROHS	Samtec	QTH-060-01-F-D-A
4	TOP PCB See Document #2	NUT, 4-40, HEX, NYLON, ROHS	Essentra Components	0400440HN
4	TOP PCB See Document #2	SCREW, 4-40×7/16, PANHEAD, SLOTTED, NYLON	Essentra Components	010440P043

2.3 Board Layout

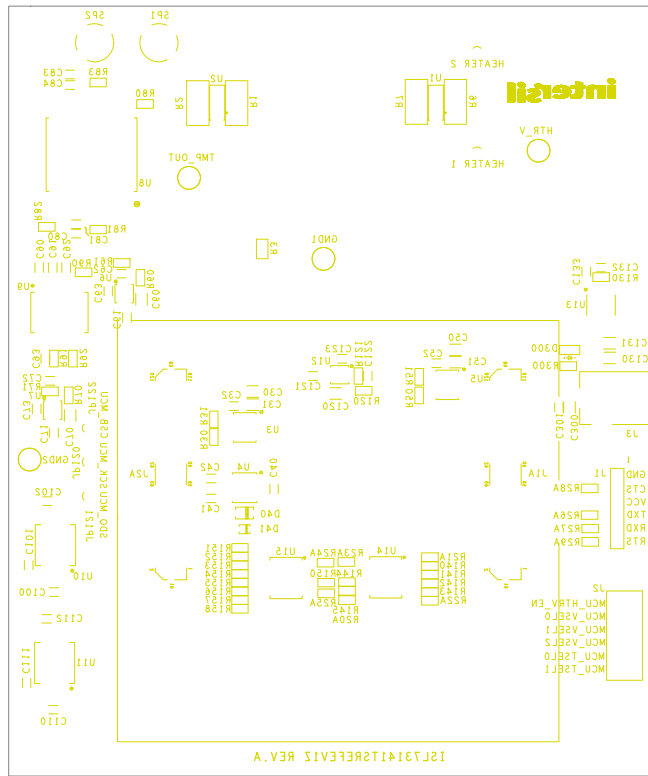

Figure 37. Top Silkscreen

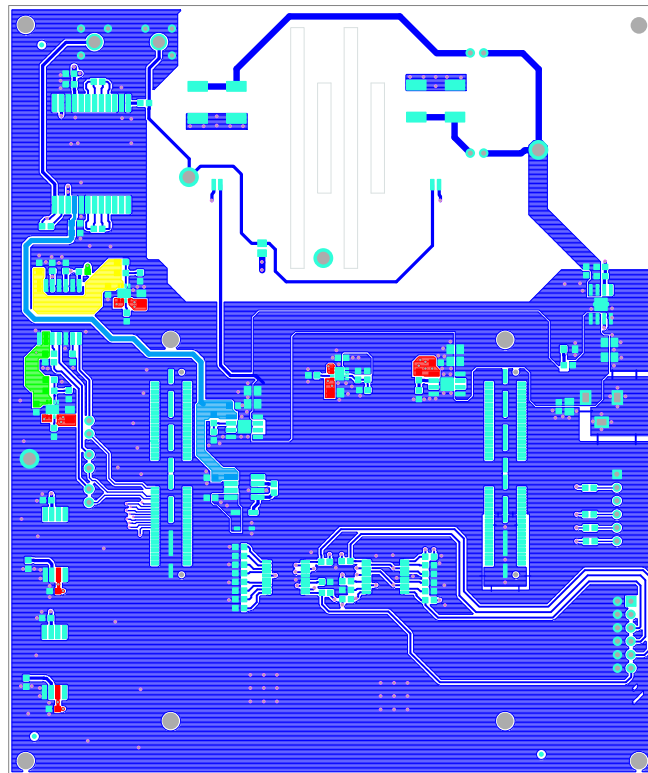

Figure 38. Top Layer

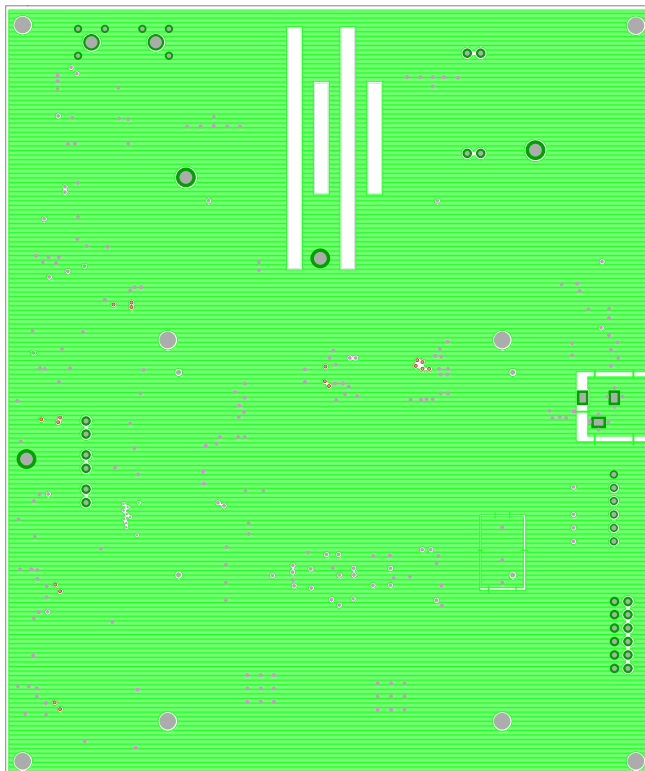

Figure 39. Layer 2

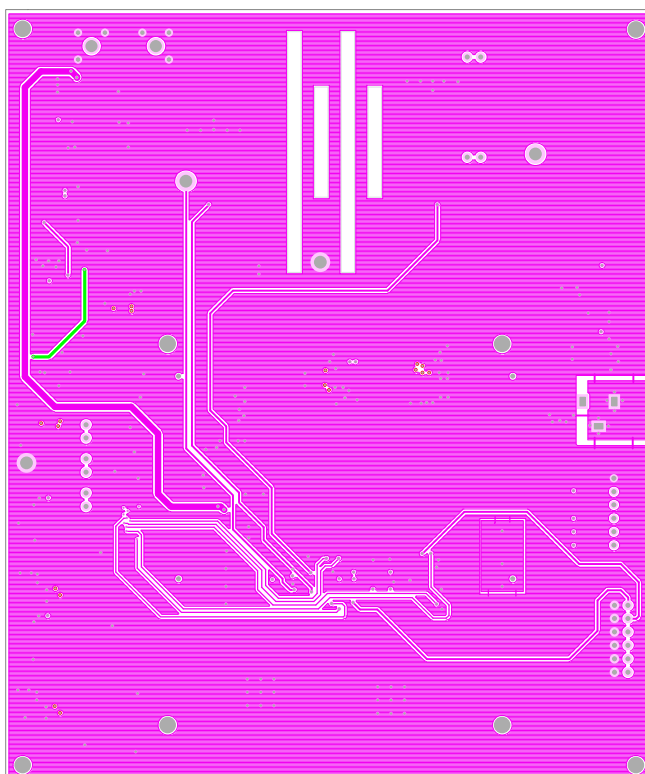

Figure 40. Layer 3

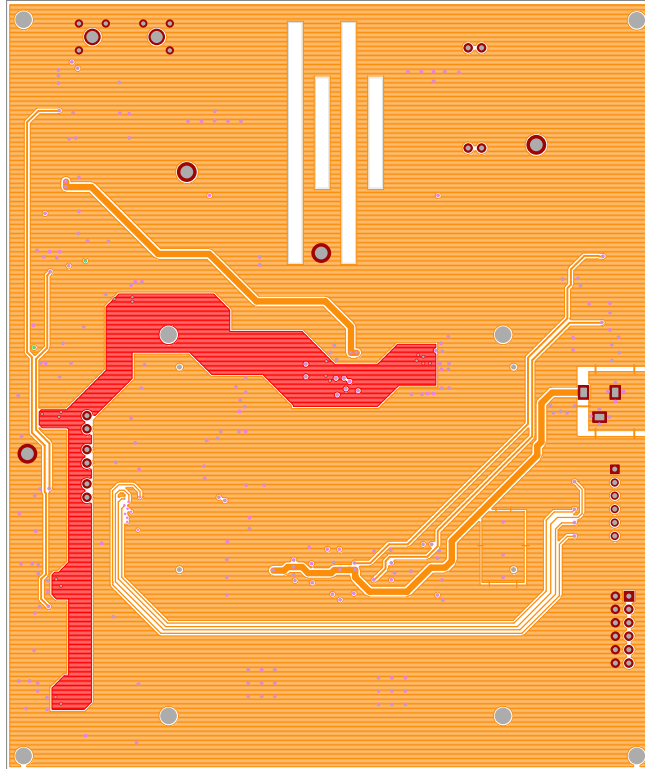

Figure 41. Bottom Layer

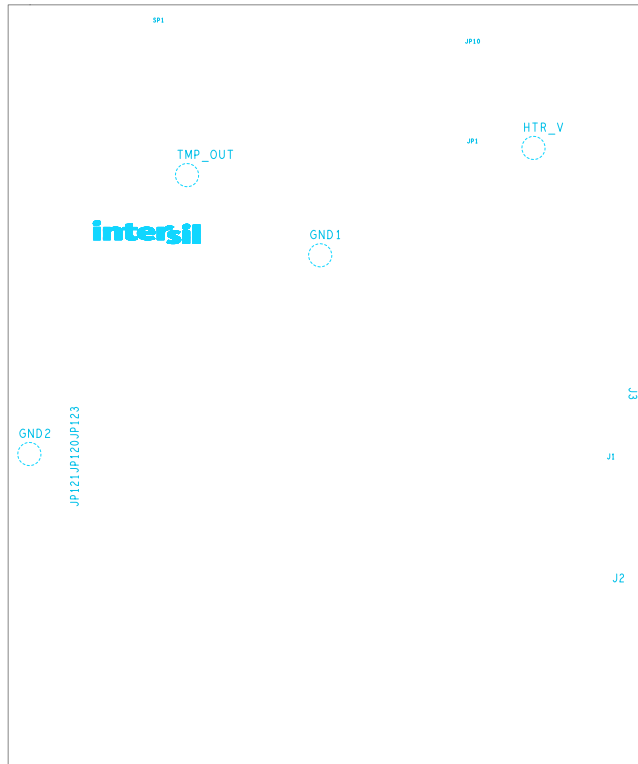

Figure 42. Bottom Silkscreen

3. Ordering Information

Part Number	Description
ISL73141TSREFEVKIT1Z	ISL73141SEH Temperature Sensing Reference Design Kit
ISL73141TSREFEV1Z	ISL73141SEH Temperature Sensing Reference Board

4. Revision History

Rev.	Date	Description
1.03	Nov 4, 2024	Updated iRADNavigator Board Selection section. Updated Figure 23. Added iRADNavigator MCU Firmware Update section.
1.02	Jun 12, 2024	Added link on page 1.
1.01	Jan 31, 2024	Updated Page 1 information. Updated Figures 2, 3, 7, 22, and 24. Updated Ordering Information.
1.00	Jan 10, 2024	Initial release

IMPORTANT NOTICE AND DISCLAIMER

RENESAS ELECTRONICS CORPORATION AND ITS SUBSIDIARIES (“RENESAS”) PROVIDES TECHNICAL SPECIFICATIONS AND RELIABILITY DATA (INCLUDING DATASHEETS), DESIGN RESOURCES (INCLUDING REFERENCE DESIGNS), APPLICATION OR OTHER DESIGN ADVICE, WEB TOOLS, SAFETY INFORMATION, AND OTHER RESOURCES “AS IS” AND WITH ALL FAULTS, AND DISCLAIMS ALL WARRANTIES, EXPRESS OR IMPLIED, INCLUDING, WITHOUT LIMITATION, ANY IMPLIED WARRANTIES OF MERCHANTABILITY, FITNESS FOR A PARTICULAR PURPOSE, OR NON-INFRINGEMENT OF THIRD-PARTY INTELLECTUAL PROPERTY RIGHTS.

These resources are intended for developers who are designing with Renesas products. You are solely responsible for (1) selecting the appropriate products for your application, (2) designing, validating, and testing your application, and (3) ensuring your application meets applicable standards, and any other safety, security, or other requirements. These resources are subject to change without notice. Renesas grants you permission to use these resources only to develop an application that uses Renesas products. Other reproduction or use of these resources is strictly prohibited. No license is granted to any other Renesas intellectual property or to any third-party intellectual property. Renesas disclaims responsibility for, and you will fully indemnify Renesas and its representatives against, any claims, damages, costs, losses, or liabilities arising from your use of these resources. Renesas' products are provided only subject to Renesas' Terms and Conditions of Sale or other applicable terms agreed to in writing. No use of any Renesas resources expands or otherwise alters any applicable warranties or warranty disclaimers for these products.

(Disclaimer Rev.1.01 Jan 2024)

Corporate Headquarters

TOYOSU FORESIA, 3-2-24 Toyosu,
Koto-ku, Tokyo 135-0061, Japan
www.renesas.com

Trademarks

Renesas and the Renesas logo are trademarks of Renesas Electronics Corporation. All trademarks and registered trademarks are the property of their respective owners.

Contact Information

For further information on a product, technology, the most up-to-date version of a document, or your nearest sales office, please visit www.renesas.com/contact-us/.