

ISL73847MDEMO1Z

The ISL73847MDEMO1Z demonstration board demonstrates the performance of the [ISL73847M](#) dual-phase buck controller. The board is optimized for a 4.5V to 15V input operation to generate a 50A max, 1V output.

**Features**

- Power-Good LED indicator
- Integrated LDO (VCC)
- Droop regulation set by a single resistor

**Specifications**

- Input voltage supply ( $V_{IN}$ ): 4.5V to 15V
- Preset output voltage ( $V_{OUT}$ ): 1V
- Preset switching frequency: 500kHz
- Maximum load current: 50A
- Preset droop regulation

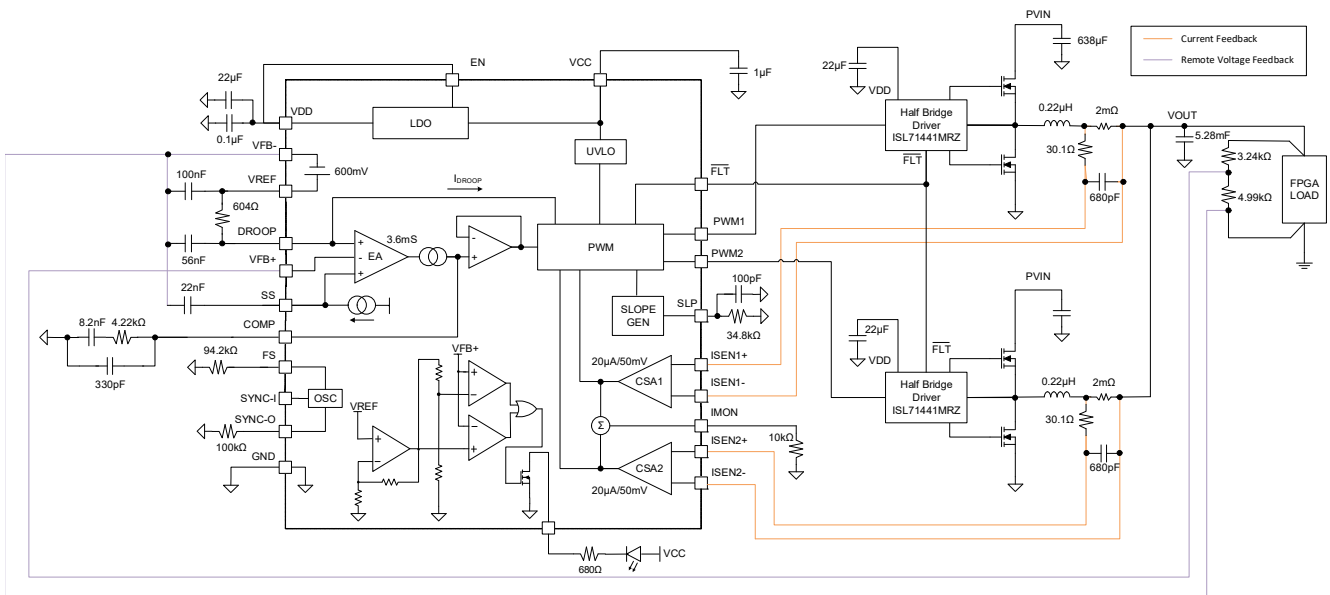

Figure 1. ISL73847MDEMO1Z Block Diagram

## Contents

<b>1. Functional Description</b>	<b>3</b>
1.1 Operating Range	3
1.2 Before Starting	3
1.3 Quick-Start Guide	3
1.4 Changing the Switching Frequency	4
1.5 Soft-Start Adjustment	4
1.6 Droop Regulation	4
1.7 IMON	4
1.8 Enabling/Disabling	5
<b>2. Board Design</b>	<b>5</b>
2.1 Layout Guidelines	5
2.2 Schematic Diagrams	6
2.3 Bill of Materials	8
2.4 Board Layout	10
<b>3. Typical Performance Graphs</b>	<b>15</b>
<b>4. Ordering Information</b>	<b>16</b>
<b>5. Revision History</b>	<b>16</b>

# 1. Functional Description

## 1.1 Operating Range

The ISL73847MDEMO1Z board requires one input supply ( $V_{IN}$ ) to operate properly. This supply powers the ISL73847M controller analog supply input, plus additional supporting circuitry and the onboard buck power supply input. You can set the  $V_{IN}$  supply from 4.5V to 15V. The buck regulator circuit is preset for a 1V output voltage and a switching frequency of 500kHz with a 0.22 $\mu$ H output inductor and 2.64mF output capacitance per phase with the option of being synchronized to an external clock using SYNC-I.

## 1.2 Before Starting

The board does not come with any connectors. To properly use the board, you must solder connectors to the  $V_{IN}$ , GND, and  $V_{OUT}$  solder pads.

## 1.3 Quick-Start Guide

1. Apply a 4.5V to 15V voltage to  $V_{IN}$  connectors, as shown in [Figure 2](#). To use 4w sense lines from a power supply or a voltmeter to monitor the input voltage, solder a jumper to TP1.
2. If required, a resistor or electronic load can be connected to the  $V_{OUT}$  connectors, as shown in [Figure 2](#). To use 4w sense lines from an electronic load, solder a jumper to TP2.

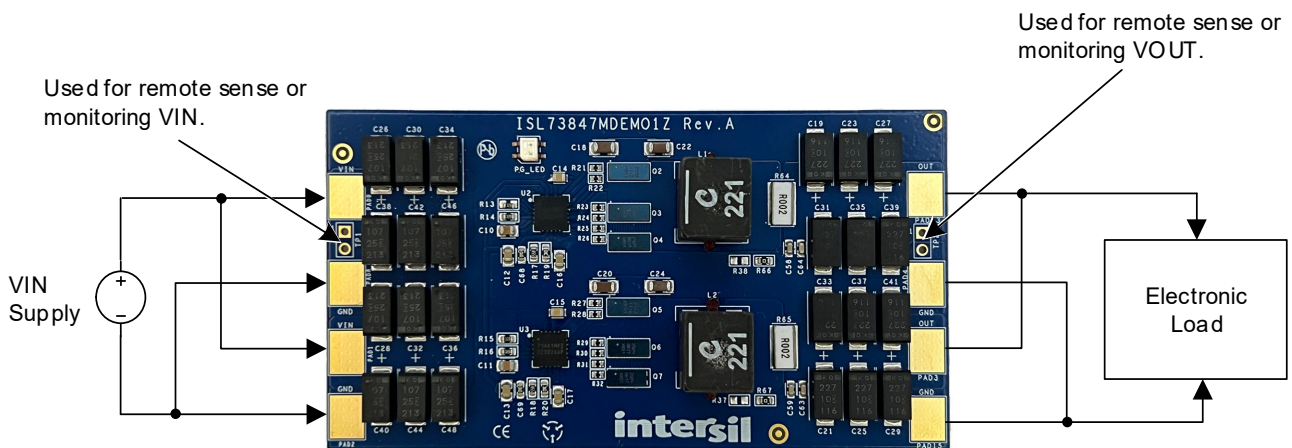

Figure 2. ISL73847MDEMO1Z Board Setup

## 1.4 Changing the Switching Frequency

The ISL73847MDEMO1Z is configured for a 500kHz switching frequency by a 94.2k $\Omega$  pull-down resistor ( $R_2$ ) on the FS pin. The demonstration board includes a 0.22 $\mu$ H inductor and an array of output bypass capacitors for a 2.64mF output capacitance per phase, which makes up the LC filter. If you need to select a different switching frequency, see [Figure 3](#) for choosing the appropriate  $R_2$  value on FS. For more information about the FS pin, refer to the *ISL73847M datasheet*.

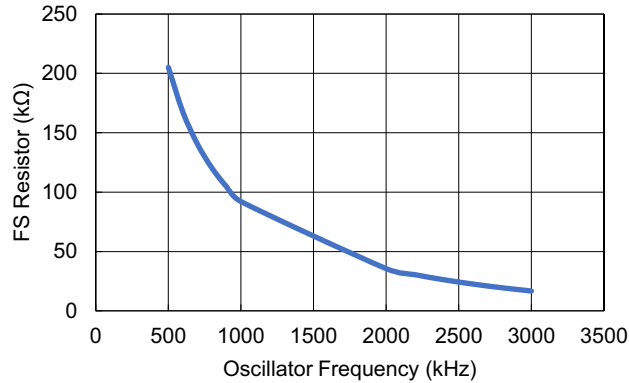

Figure 3.  $R_{FS}$  vs Frequency

## 1.5 Soft-Start Adjustment

The ISL73847MDEMO1Z is configured for a 2ms soft-start (SS) time by a 22nF bypass capacitor ( $C_2$ ) connected to the SS pin. The SS time can be adjusted from 2ms to 200ms by changing the  $C_2$  capacitor. If you must select a different soft-start time, use [Equation 1](#) to calculate the capacitance given the required soft-start time. For more information on SS, refer to the *ISL73847M datasheet*.

$$(EQ. 1) \quad C_{SS} = \frac{t_{SS} \times 1 \times 10^{-5}}{V_{REF}}$$

where:

- $C_{SS}$  is the soft-start capacitance in Farads
- $t_{SS}$  is the required soft-start time in seconds
- $V_{REF}$  is the reference voltage, which is nominally 0.6V

## 1.6 Droop Regulation

The ISL73847MDEMO1Z minimizes peak-to-peak transient response excursions by using a 604 $\Omega$  resistor ( $R_1$ ) connected between the VREF and DROOP pins. If droop regulation is unnecessary, replace the 604 $\Omega$  with a 0 $\Omega$  resistor to short the VREF and DROOP pins together. For more information about the droop regulation, refer to the *ISL73847M datasheet*.

## 1.7 IMON

The ISL73847MDEMO1Z monitors the average current through the inductor as a voltage on the IMON pin. A 10k $\Omega$  pull-down resistor ( $R_{10}$ ) is connected to the IMON pin. A 100pF bypass capacitor is added in parallel to  $R_{10}$  to improve averaging. For more information about the IMON pin, refer to the *ISL73847M datasheet*.

## 1.8 Enabling/Disabling

The ISL73847MDEMO1Z automatically enables when VDD reaches a certain voltage on power-up by a 4.99kΩ resistor (R<sub>6</sub>) connected between EN and VDD. For more information about enabling and disabling the controller, refer to the *ISL73847M datasheet*.

## 2. Board Design

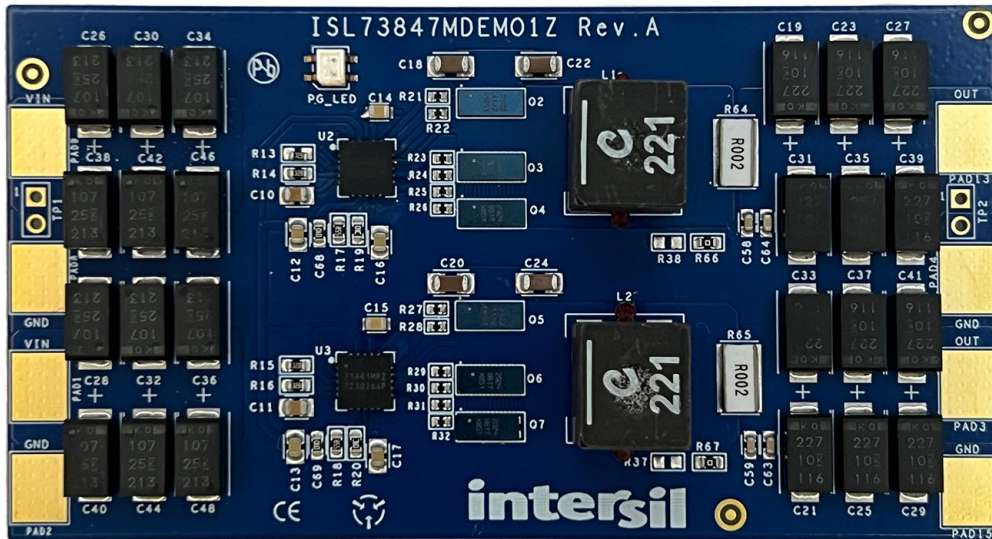

Figure 4. ISL73847MDEMO1Z Evaluation Board (Top)

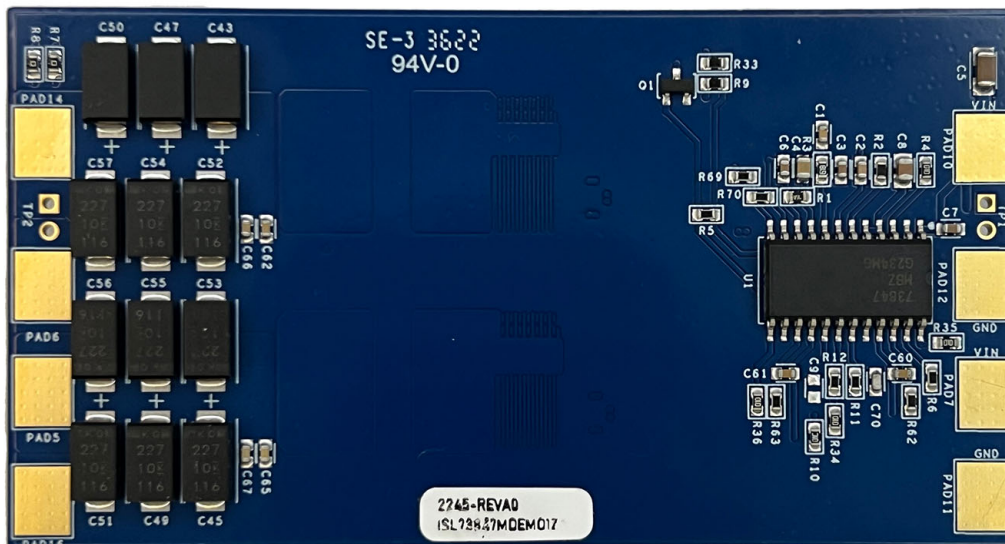

Figure 5. ISL73847MDEMO1Z Evaluation Board (Bottom)

## 2.1 Layout Guidelines

For detailed information about layout guidelines, refer to the *ISL73847M Datasheet*.

## 2.2 Schematic Diagrams

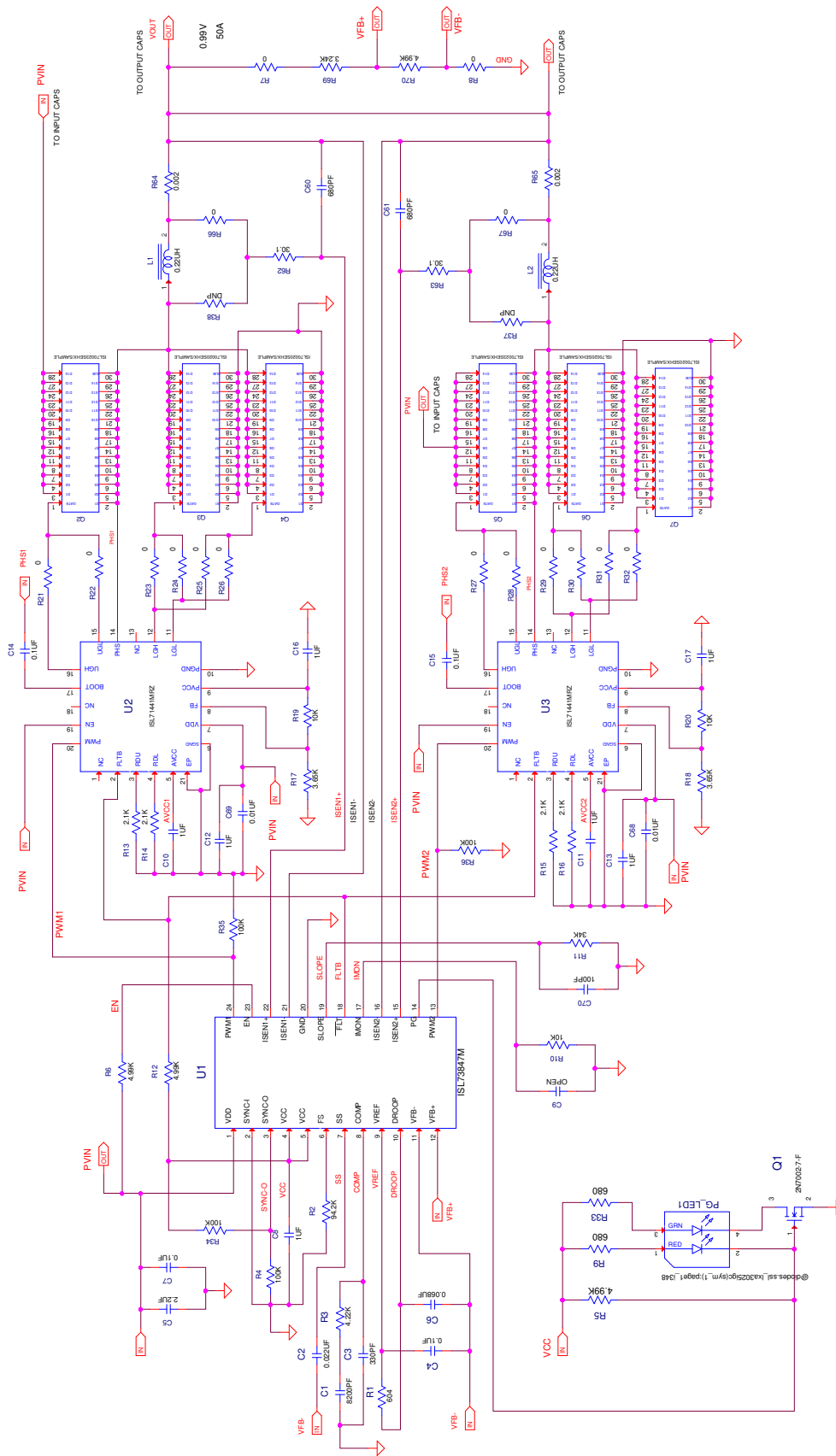

Figure 6. ISL73847MDEMO1Z Schematic (Page 1)

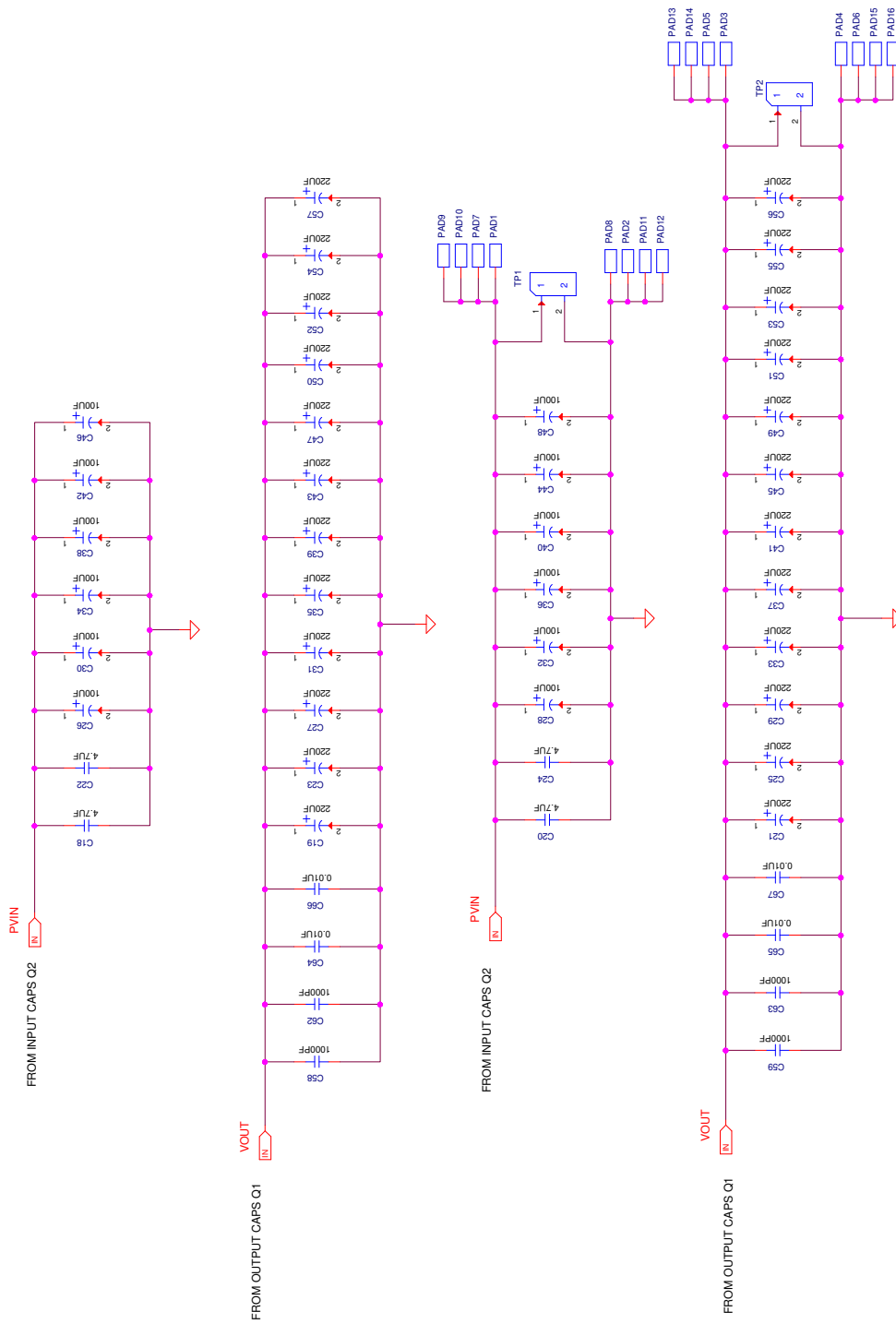

Figure 7. ISL73847MDEMO1Z Schematic (Page 2)

## 2.3 Bill of Materials

Qty	Reference Designator	Description	Manufacturer	Manufacturer Part
1		PWB-PCB, ISL73847MDEMO1Z, REVB, ROHS	Imagineering Inc	ISL73847MDEMO1ZREVBPCB
1	C6	CAP, SMD, 0603, 0.056 $\mu$ F, 50V, 10%, X7R, ROHS	Kemet	C0603X563K5RAC7867
3	C8, C10, C11	CAP, SMD, 0805, 1.0 $\mu$ F, 25V, 10%, X7R, ROHS	TDK	C2012X7R1E105K
1	C5	CAP-AEC-Q200, SMD,1206, 2.2 $\mu$ F, 25V, 10%, X7R, ROHS	Murata	GCJ31MR71E225KA12L
1	C70	CAP, SMD, 0603, 100pF, 25V, 10%, X7R, ROHS	Kemet	C0603C101K3RAC7867
4	C58, C59, C62, C63	CAP, SMD, 0603, 1000pF, 16V, 10%, X7R, ROHS	Venkel	C0603X7R160102KNE
4	C64-C67	CAP, SMD, 0603, 0.01 $\mu$ F, 16V, 10%, X7R, ROHS	Venkel	C0603X7R160-103KNE
2	C68, C69	CAP, SMD, 0603, 0.01 $\mu$ F, 25V, 10%, X7R, ROHS	Venkel	C0603X7R250-103KNE
3	C4, C14, C15	CAP, SMD, 0603, 0.1 $\mu$ F, 25V, 10%, X7R, ROHS	Yageo	CC0603KRX7R8BB104
1	C7	CAP, SMD, 0603, 0.1 $\mu$ F, 50V, 10%, X7R, ROHS	AVX	06035C104KAT2A
1	C2	CAP, SMD, 0603, 0.022 $\mu$ F, 16V, 10%, X7R, ROHS	Venkel	C0603X7R160-223K
1	C3	CAP, SMD, 0603, 330pF, 50V, 10%, X7R, ROHS	Yageo	CC0603KRX7R8BB104
2	C60, C61	CAP, SMD, 0603, 680pF, 50V, 10%, X7R, ROHS	Murata	GRM188R71H681KA01D
1	C9	CAP, SMD, 0603, DNP- PLACE HOLDER, ROHS		
4	C12, C13, C16, C17	CAP, SMD, 0805, 1.0 $\mu$ F, 25V, 10%, X5R, ROHS	AVX	08053D105KAT4A
24	C19, C21, C23, C25, C27, C29, C31, C33, C35, C37, C39, C41, C43, C45, C47, C49, C50, C51, C52, C53, C54, C55, C56, C57	CAP-TANT, SMD, 7.3 $\times$ 4.3 $\times$ 2.8, 220 $\mu$ F, 10V, 20%, 6m $\Omega$ , ROHS	Kemet	T521X107M025ATE030
1	C1	CAP, SMD, 0603, 8200pF, 50V, 5%, X7R, ROHS	Vishay/Vitramon	VJ0603Y822JXACW1BC
2	L1, L2	COIL-PWR INDUCT, AEC- Q200, SMD, 11.3 $\times$ 10mm, 0.22 $\mu$ H, 20%, 98.8A, ROHS	Coilcraft	XAL1010-221MEB
1	PG_LED	LED, SMD, 3 $\times$ 2.5mm, 4P, RED/GREEN, 12/20MCD, 2V	Lumex	SSL-LXA3025IGC-TR



Qty	Reference Designator	Description	Manufacturer	Manufacturer Part
4	Q3, Q4, Q6, Q7	TRANSISTOR, RAD HARD, 40V GAN FET, 4P, CLCC, ROHS	Renesas Electronics	ISL70020SEHX/SAMPLE
2	Q2, Q5	IC-PROTO, RAD-HARD, 100V, GAN FET, 4P, CLCC, ROHS	Renesas Electronics	ISL70023SEHX/SAMPLE
2	U2, U3	IC-GAN FET DRIVER, HALF-BRIDGE, 20P, QFN, ROHS	Renesas Electronics	ISL71441MRZ
1	U1	IC-RAD LIGHT BUCK CONTROLLER, 24P, FP, ROHS	Renesas Electronics	ISL73847MBZ
1	Q1	TRANSISTOR, N-CHANNEL, 3LD, SOT-23, 60V, 115mA, ROHS	Diodes, Inc.	2N7002-7-F
12	R21-R32	RES-AEC-Q200, SMD, 0402, 0Ω, 1/16W, TF, ROHS	Vishay/Dale	CRCW04020000Z0ED
2	R9, R33	RES-AEC-Q200, SMD, 0603, 680Ω, 1/10W, 1%, TF, ROHS	Vishay/Dale	CRCW0603680RFKEA
2	R19, R20	RES, SMD, 0402, 10K, 1/16W, 1%, TF, ROHS	Panasonic	ERJ-2RKF1002X
2	R17, R18	RES, SMD, 0402, 3.65K, 1/16W, 1%, TF, ROHS	Panasonic	ERJ-2RKF3651
2	R7, R8	RES, SMD, 0603, 0Ω, 1/10W, TF, ROHS	Venkel	CR0603-10W-000T
1	R10	RES, SMD, 0603, 10K, 1/10W, 1%, TF, ROHS	Venkel	CR0603-10W-1002FT
4	R4, R34-36	RES, SMD, 0603, 100K, 1/10W, 1%, TF, ROHS	Venkel	CR0603-10W-1003FT
4	R13-R16	RES, SMD, 0603, 2.1K, 1/10W, 1%, TF, ROHS	Panasonic	ERJ-3EKF2101V
2	R62, R63	RES, SMD, 0603, 30.1Ω, 1/10W, 1%, TF, ROHS	Yageo	RC0603FR-0730R1L
1	R69	RES, SMD, 0603, 3.24K, 1/10W, 1%, TF, ROHS	Panasonic	ERJ-3EKF3241V
1	R11	RES, SMD, 0603, 34.8K, 1/10W, 1%, TF, ROHS	Venkel	CR0603-10W-3482FT
1	R3	RES, SMD, 0603, 4.22K, 1/10W, 1%, TF, ROHS	Rohm	MCR03EZPFX4221
4	R5, R6, R12, R70	RES, SMD, 0603, 4.99K, 1/10W, 1%, TF, ROHS	Panasonic	ERJ-3EKF4991V
1	R1	RES, SMD, 0603, 604Ω, 1/10W, 1%, TF, ROHS	Panasonic	ERJ-3EKF6040V
1	R2	RES, SMD, 0603, 94.2K, 1/10W, 0.1%, THINFILM, ROHS	Yageo	RT0603BRD0794K2L

Qty	Reference Designator	Description	Manufacturer	Manufacturer Part
4	Four corners	BUMPONS,0.44inWx0.20in H,CYLINDRICAL DOME,BLK,ROHS	3M	SJ-5003 (BLACK)
0	TP1, TP2	DNP		

## 2.4 Board Layout

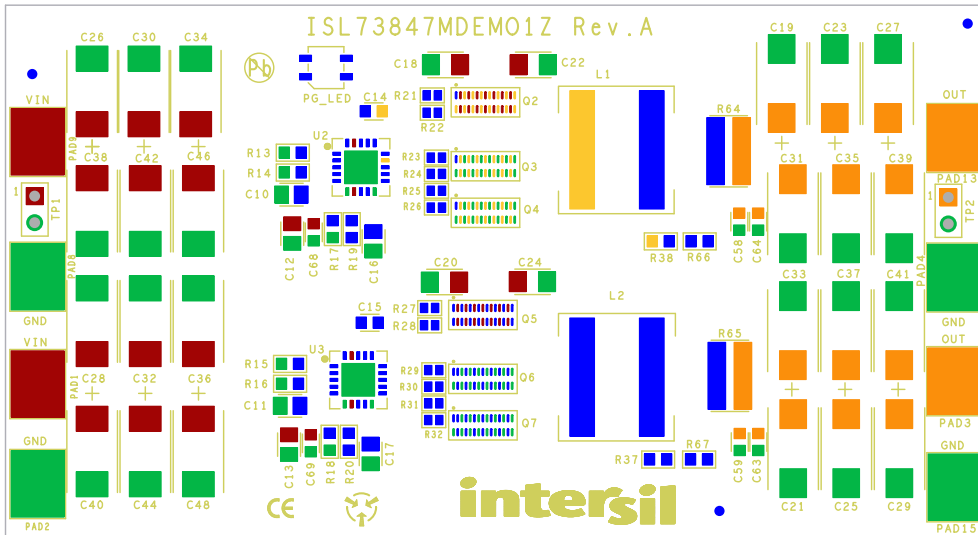

Figure 8. Silkscreen Top Layer

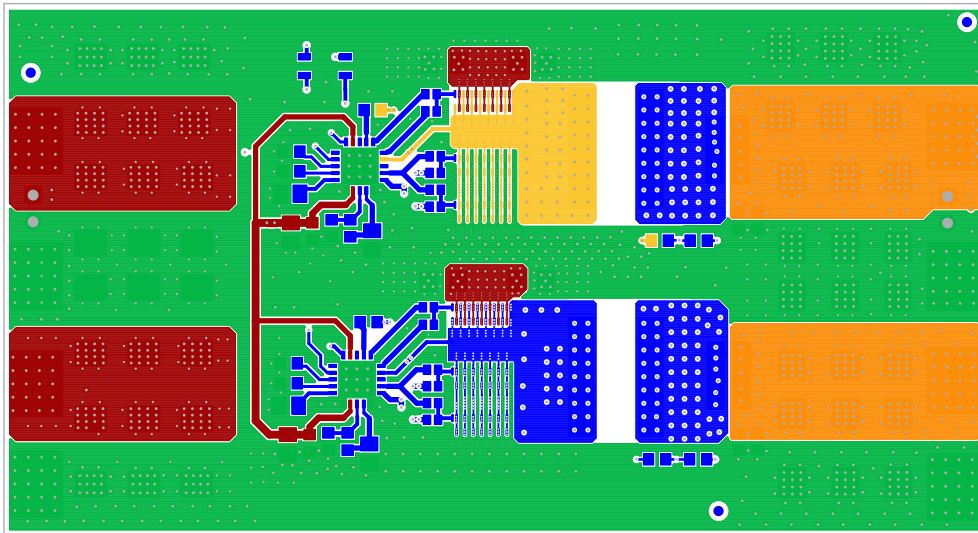

Figure 9. Top Layer

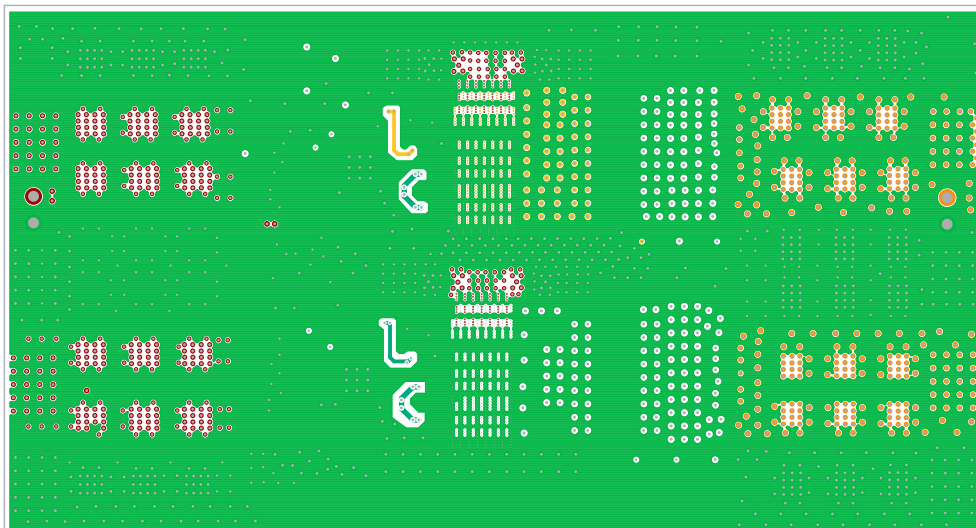

Figure 10. Layer 2

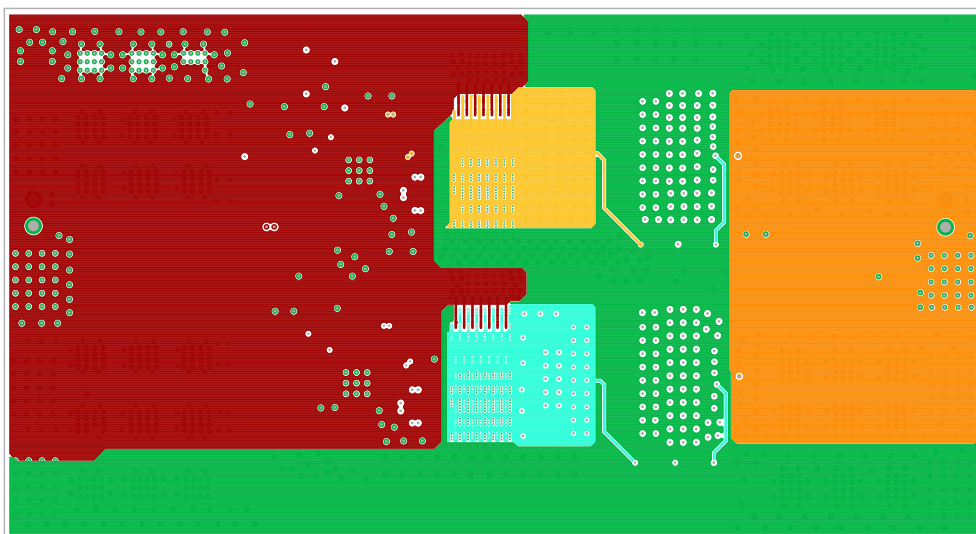

Figure 11. Layer 3

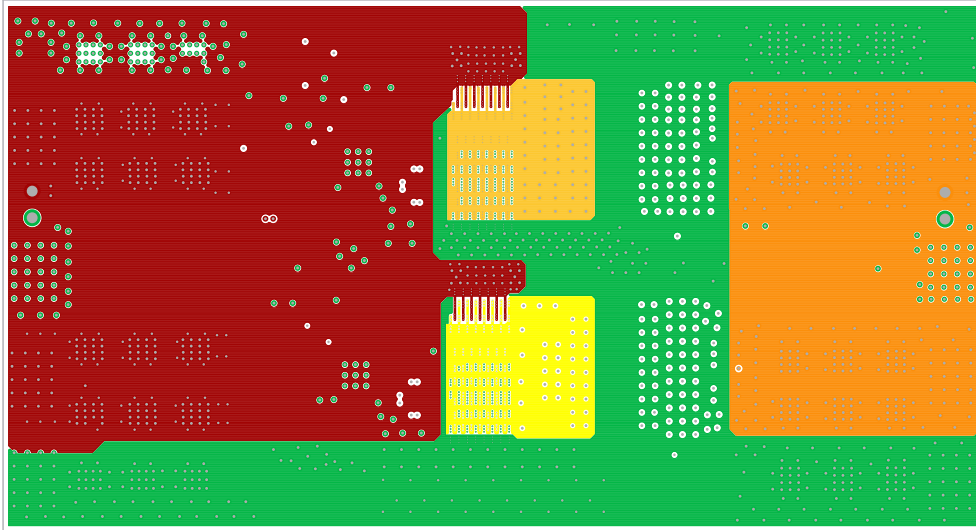

Figure 12. Layer 4

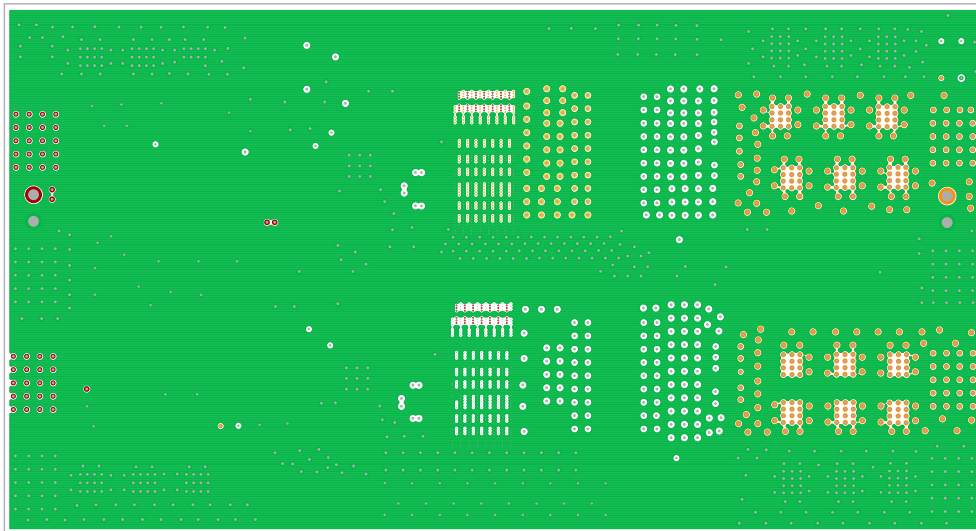

Figure 13. Layer 5

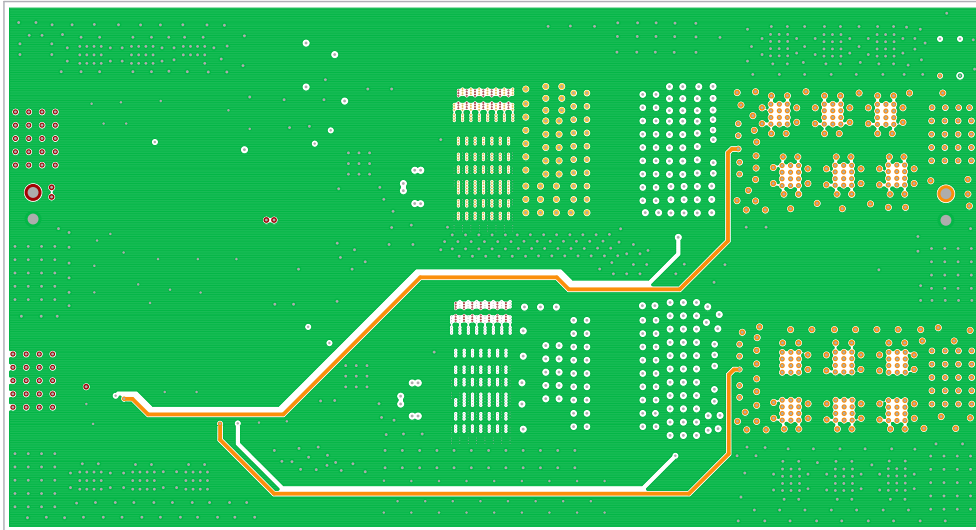

Figure 14. Layer 6

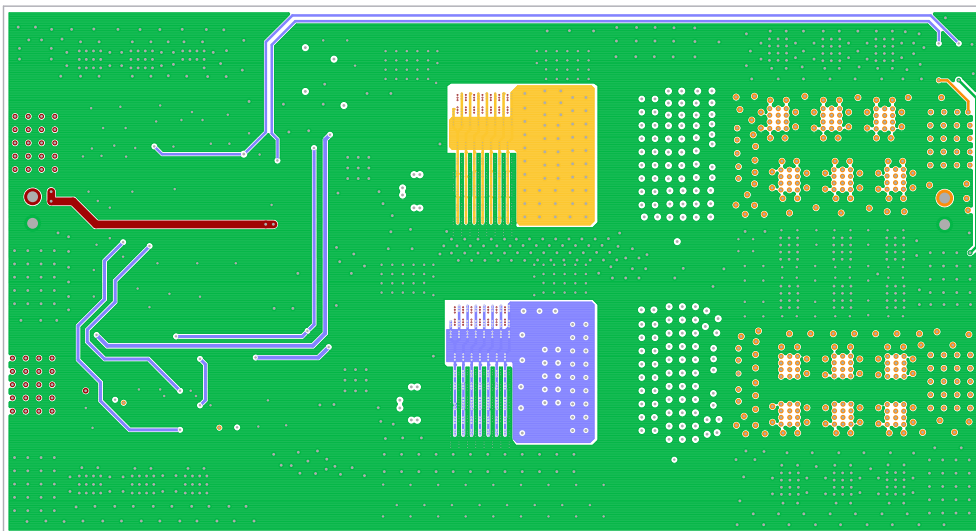

Figure 15. Layer 7

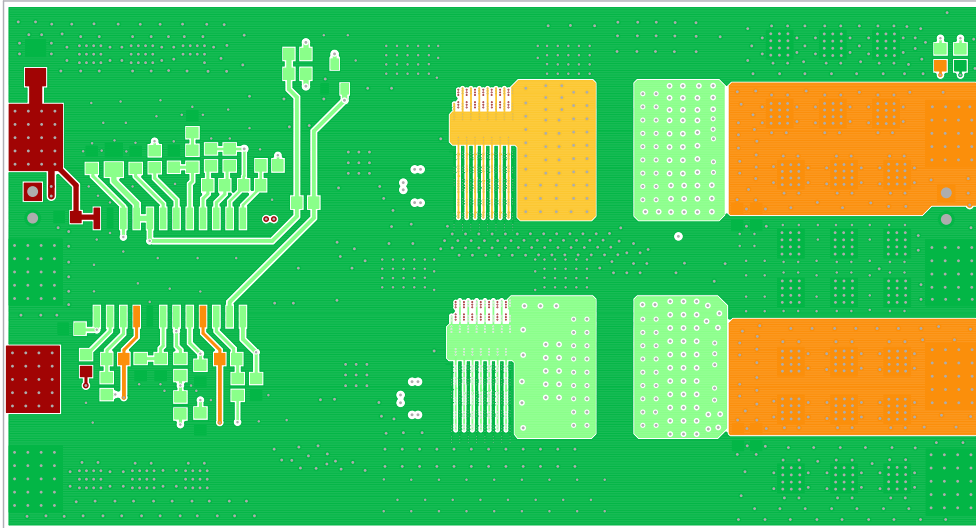

Figure 16. Bottom Layer

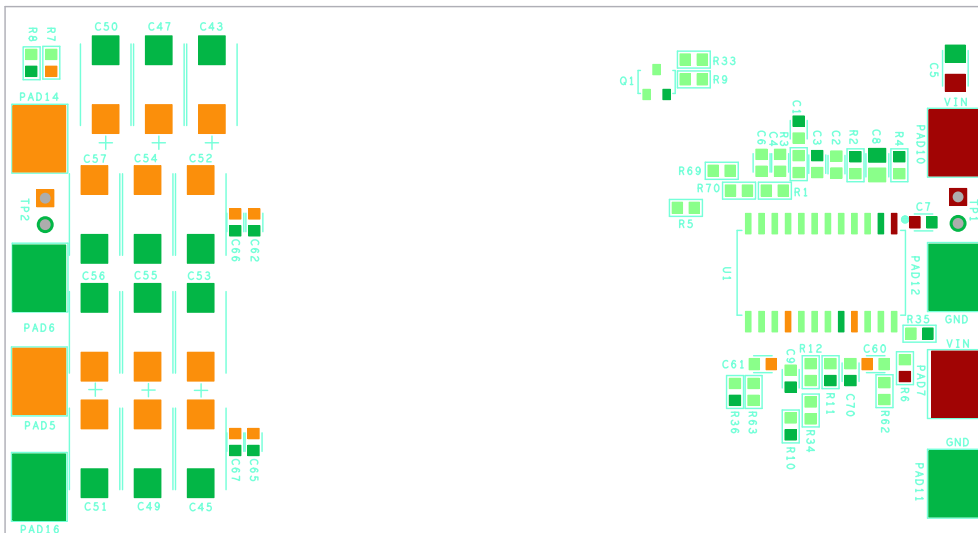
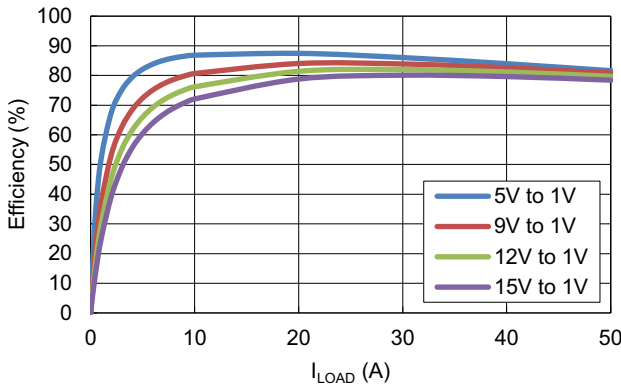

Figure 17. Silkscreen Bottom Layer

### 3. Typical Performance Graphs

Unless otherwise noted,  $V_{OUT} = 1V$ ;  $L_{OUT} = 220nH$  per phase,  $C_{OUT} = 2.64mF$  per phase,  $C_{DROOP} = 56nF$ ,  $C_{VREF} = 100nF$ ,  $R_{DROOP} = 0\Omega$ ,  $R_{FS} = 94.2k\Omega$ ,  $C_{SS} = 22nF$ ,  $C_{COMP} = 8.2nF$ ,  $R_{COMP} = 4.22k\Omega$ ,  $C_{POLE} = 330pF$ ,  $C_{VCC} = 1\mu F$ ,  $R_{SLP} = 34.8k\Omega$ ,  $C_{SLP} = 100pF$ ,  $T_A = +25^\circ C$



**Figure 18. Conversion Efficiency for Various  $V_{IN}$**   
 ( $f_{SW} = 500kHz$ , ISL70020SEHX, ISL70023SEHX,  
 XAL1010-221ME)

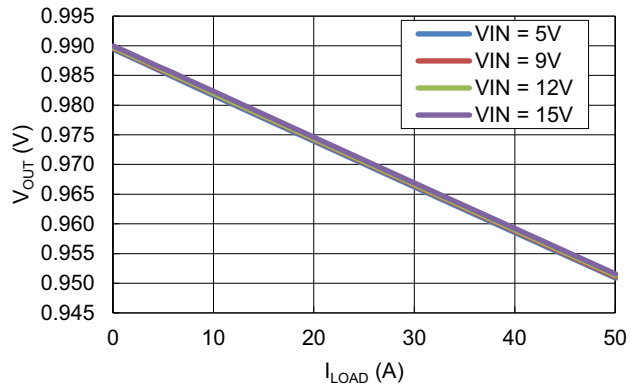

**Figure 19. Droop Regulation for Various  $V_{IN}$**   
 ( $R_{DROOP} = 604\Omega$ )

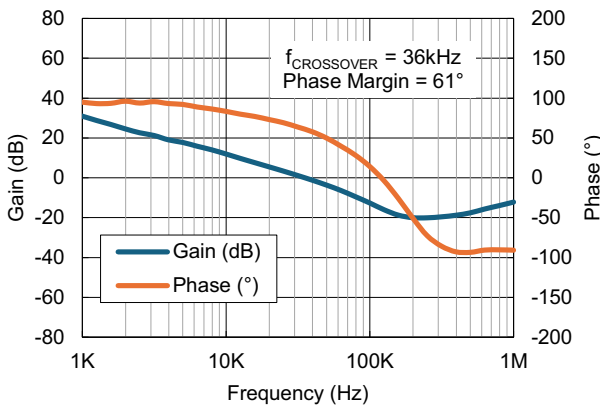

**Figure 20. Gain and Phase vs Frequency ( $V_{IN} = 5V$ ,  
 $I_{LOAD} = 0A$ ,  $f_{SW} = 500kHz$ )**

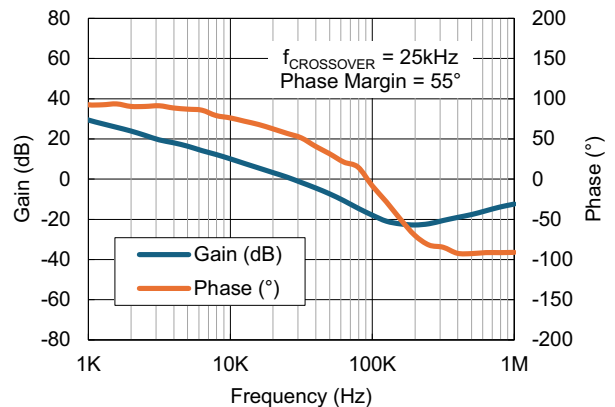

**Figure 21. Gain and Phase vs Frequency ( $V_{IN} = 12V$ ,  
 $I_{LOAD} = 0A$ ,  $f_{SW} = 500kHz$ )**

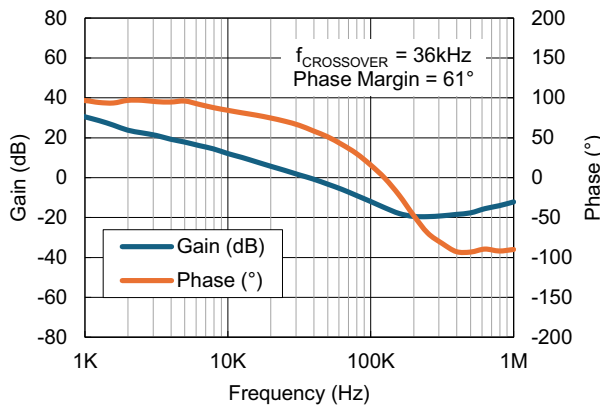

**Figure 22. Gain and Phase vs Frequency ( $V_{IN} = 5V$ ,  
 $I_{LOAD} = 25A$ ,  $f_{SW} = 500kHz$ )**

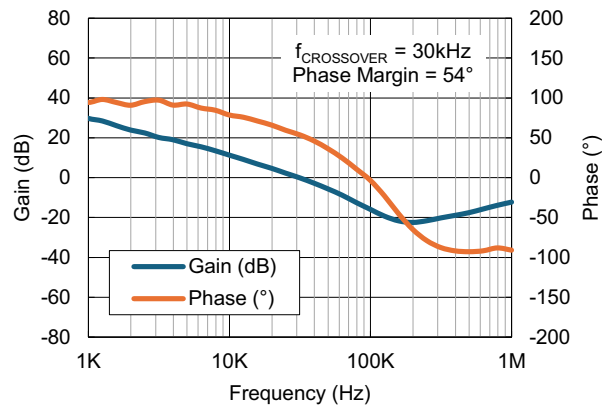

**Figure 23. Gain and Phase vs Frequency ( $V_{IN} = 12V$ ,  
 $I_{LOAD} = 25A$ ,  $f_{SW} = 500kHz$ )**

Unless otherwise noted,  $V_{OUT} = 1V$ ;  $L_{OUT} = 220nH$  per phase,  $C_{OUT} = 2.64mF$  per phase,  $C_{DROOP} = 56nF$ ,  $C_{VREF} = 100nF$ ,  $R_{DROOP} = 0\Omega$ ,  $R_{FS} = 94.2k\Omega$ ,  $C_{SS} = 22nF$ ,  $C_{COMP} = 8.2nF$ ,  $R_{COMP} = 4.22k\Omega$ ,  $C_{POLE} = 330pF$ ,  $C_{VCC} = 1\mu F$ ,  $R_{SLP} = 34.8k\Omega$ ,  $C_{SLP} = 100pF$ ,  $T_A = +25^\circ C$  (Cont.)

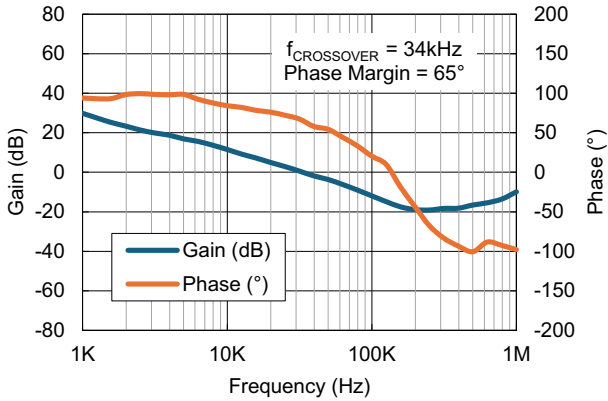

Figure 24. Gain and Phase vs Frequency ( $V_{IN} = 5V$ ,  $I_{LOAD} = 50A$ ,  $f_{SW} = 500kHz$ )

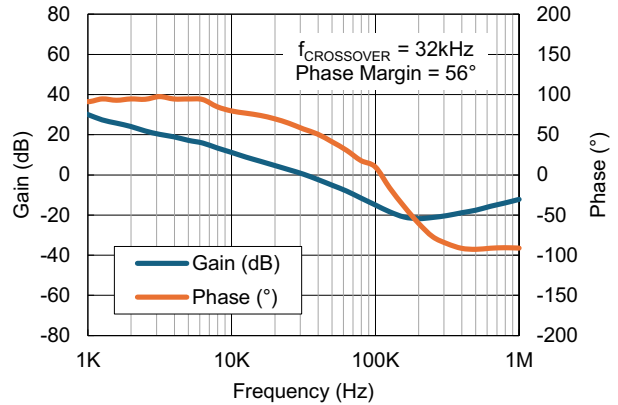

Figure 25. Gain and Phase vs Frequency ( $V_{IN} = 12V$ ,  $I_{LOAD} = 50A$ ,  $f_{SW} = 500kHz$ )

## 4. Ordering Information

Part Number	Description
ISL73847MDEMO1Z	ISL73847M demonstration board

## 5. Revision History

Revision	Date	Description
1.01	May 13, 2024	Added Figures 20 through 25.
1.00	Apr 14, 2023	Initial release



## IMPORTANT NOTICE AND DISCLAIMER

RENESAS ELECTRONICS CORPORATION AND ITS SUBSIDIARIES (“RENESAS”) PROVIDES TECHNICAL SPECIFICATIONS AND RELIABILITY DATA (INCLUDING DATASHEETS), DESIGN RESOURCES (INCLUDING REFERENCE DESIGNS), APPLICATION OR OTHER DESIGN ADVICE, WEB TOOLS, SAFETY INFORMATION, AND OTHER RESOURCES “AS IS” AND WITH ALL FAULTS, AND DISCLAIMS ALL WARRANTIES, EXPRESS OR IMPLIED, INCLUDING, WITHOUT LIMITATION, ANY IMPLIED WARRANTIES OF MERCHANTABILITY, FITNESS FOR A PARTICULAR PURPOSE, OR NON-INFRINGEMENT OF THIRD-PARTY INTELLECTUAL PROPERTY RIGHTS.

These resources are intended for developers who are designing with Renesas products. You are solely responsible for (1) selecting the appropriate products for your application, (2) designing, validating, and testing your application, and (3) ensuring your application meets applicable standards, and any other safety, security, or other requirements. These resources are subject to change without notice. Renesas grants you permission to use these resources only to develop an application that uses Renesas products. Other reproduction or use of these resources is strictly prohibited. No license is granted to any other Renesas intellectual property or to any third-party intellectual property. Renesas disclaims responsibility for, and you will fully indemnify Renesas and its representatives against, any claims, damages, costs, losses, or liabilities arising from your use of these resources. Renesas' products are provided only subject to Renesas' Terms and Conditions of Sale or other applicable terms agreed to in writing. No use of any Renesas resources expands or otherwise alters any applicable warranties or warranty disclaimers for these products.

(Disclaimer Rev.1.01 Jan 2024)

### Corporate Headquarters

TOYOSU FORESIA, 3-2-24 Toyosu,  
Koto-ku, Tokyo 135-0061, Japan  
[www.renesas.com](http://www.renesas.com)

### Trademarks

Renesas and the Renesas logo are trademarks of Renesas Electronics Corporation. All trademarks and registered trademarks are the property of their respective owners.

### Contact Information

For further information on a product, technology, the most up-to-date version of a document, or your nearest sales office, please visit [www.renesas.com/contact-us/](http://www.renesas.com/contact-us/).