

ISL78692EVAL1Z

Evaluation Board User Guide

UG001
Rev 0.00
September 10, 2014

Description

The ISL78692EVAL1Z is a complete platform for the evaluation on all datasheet specifications and functionalities. The onboard 8-bit DIP switch facilitates battery charge current programming, setting EN input, temperature monitoring status, and so on. The four jumpers can set up input source selection, USB mode selection, and can be used to make other necessary connections.

The ISL78692EVAL1Z board is intended to provide an evaluation platform for the 3mmx3mm DFN ISL78692 package, single-cell Li-ion battery charger.

The device along with key components constitute a complete charger solution, demonstrating the space saving advantage of the ISL78692 in limited space applications.

LEDs connected to STATUS and FAULT pins will indicate the normal charging status or fault condition.

Onboard jumpers and a DIP switch allow the different operating conditions for the charger.

Specifications

- Ambient temperature range, -40°C to +85°C
- Supply voltage, V_{IN} = 4.3V to 5.5V
- Output voltage, V_{BAT} = 4.1V
- Trickle charge voltage, 2.8V
- Recharge threshold voltage, 3.9V
- Constant charge current, 0.5A

Key Features

- Complete charger for single-cell Li-ion batteries
- Integrated pass element and current sensor
- No external blocking diode required
- 1% voltage accuracy
- Programmable current limit up to 0.5A
- NTC thermistor interface for battery temperature monitor, 8-bit DIP switch for conveniently setting up charging current, battery thermal status, EN input, and so on.
- Different jumpers for input source selection, USB mode selection, and the convenience of current measurement.
- Test points provided for STATUS, FAULT, TIME, EN, V2P8 and TEMP functional pins to allow for monitoring the device pins.
- Board size 3.5" x 2.5" for the convenience of evaluation
- Eight thermal vias in the thermal pad
- RoHS compliant

References

- [ISL78692](#) datasheet

Ordering Information

PART #	DESCRIPTION
ISL78692EVAL1Z	Evaluation Board for the 3x3 DFN Package Part

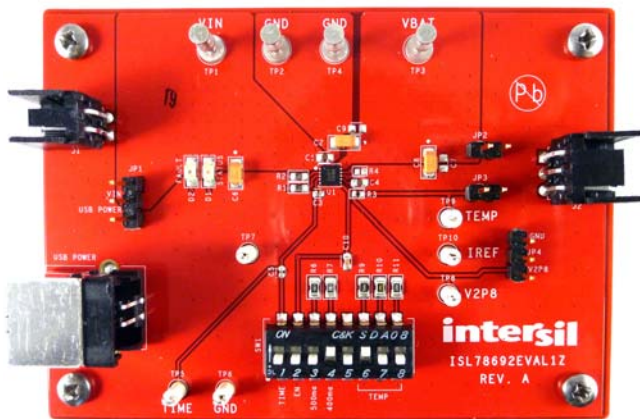

FIGURE 1. TOP VIEW



FIGURE 2. BOTTOM VIEW

What Is Inside

The Evaluation Kit contains:

- ISL78692EVAL1Z board
- The ISL78692 Datasheet
- This ISL78692EVAL1Z User Guide

What Is Needed

The following instruments will be needed to perform testing:

- Power supplies:
 - PS1: DC 20V/5A,
 - PS2: DC (sinks current) 20V/5A, such as Agilent 6654A
- Electronic load: 20V/5A
- Multimeters
- Function generator
- Oscilloscope
- Cables and wires

Quick Setup Guide

Step 1: Switch on bit 4 and bit 7 of the DIP-switch. Leave all other bits off, see [Figure 3](#).

DO NOT APPLY POWER UNTIL STEP 6

Step 2: Connect 5V to VIN.

Step 3: Connect 3.7V to VBAT.

Step 4: Connect 1.2A electronic load to VBAT.

Step 5: Verify that no shunts are connected across all jumpers.

Step 6: Turn on Power Supplies and electronic load.

Step 7: Green LED should be on, indicating normal charging operation.

Step 8: If current meter is in series with VIN, it shall read 400mA as the charging current.

DIP Switch Settings

A 9-bit DIP switch is provided to set up voltage, current reference, end-of-charge (EOC) current, and so on. The functionality of the bits are described in [Table 2](#).

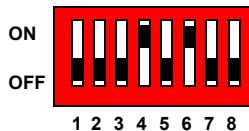

FIGURE 3. INITIAL DIP SWITCH SETTINGS

TABLE 1. JUMPER SETTINGS

JUMPER	POSITION	FUNCTION
JP1	USB TO VIN	USB connection
	WALL CUBE TO VIN	Wall adapter connection
JP2	Installed	Connect VBAT pin to battery Current meter can replace shunt
JP3	Not installed	Default
	Installed	Battery attached to Thermistor at J2
JP4	IREF and V2P8	USB 500mA
	IREF and GND	USB 100mA

TABLE 2. DIP SWITCH PIN DESCRIPTIONS

BIT	DESCRIPTION	ON	OFF	REMARK
1	Adjustable TIMEOUT	5 hours 50 mins	3 hours 30 mins	
2	Charger enable/disable	Charger disabled	Charger enabled	
3	IREF setting 1	Add 0.5A		
4	IREF setting 2	Add 0.4A		
5				Not connected
6	TEMP normal	Normal		All off simulates battery removal
7	TEMP high	Too hot		
8	TEMP low	Too cold		

Initial Board Jumper Positioning (Refer to “Schematic” on page 4)

JP1 - Selects the VIN pin connection to a wall adapter, or to USB connector. If J1 connector is being used, a shunt must be installed across JP1-1, 2 or if J3 (USB) connector is being used a shunt must be installed across JP1-2, 3. J1, J3 and JP1 can be ignored if power supply is connected directly to VIN test point, which is directly connected to the VIN pin of the IC. A current meter can replace the shunt mentioned above, so as to measure the input current.

JP2 - Connects the VBAT pin to the battery. If the J2 connector is being used, a shunt must be installed across JP2. A current meter can also replace the shunt to measure the VBAT current.

JP3 - Connects the TEMP pin to the battery. Usually no shunt is needed for JP3, as the evaluation board can simulate various battery thermal conditions. Only when a battery attached with a thermistor is applied on J2 does it become necessary to install a shunt across JP3, and at the same time, bits 6, 7, 8 on the DIP switch all need to be turned off.

JP4 - Selects USB modes: a shunt across IREF and V2P8 will set USB 500mA mode, a shunt across IREF and GND will set USB 100mA mode. When the charge current is programmed by the resistors connected to IREF pin, no shunt should be installed on JP4.

PCB Layout Recommendations

The ISL78692 internal thermal foldback function limits the charge current when the internal temperature reaches approximately +100°C. In order to maximize the current capability, it is very important that the exposed pad under the package is properly soldered to the board and is connected to other layers through thermal vias. More thermal vias and more

copper attached to the exposed pad usually result in better thermal performance. On the other hand, the number of vias is limited by the size of the pad. The 3x3 DFN package allows 9 vias be placed in three rows. Since the pins on the 3x3 DFN package are on only two sides, as much top layer copper as possible should be connected to the exposed pad to minimize the thermal impedance. Refer to [“PCB Layout”](#) starting on [page 6](#).

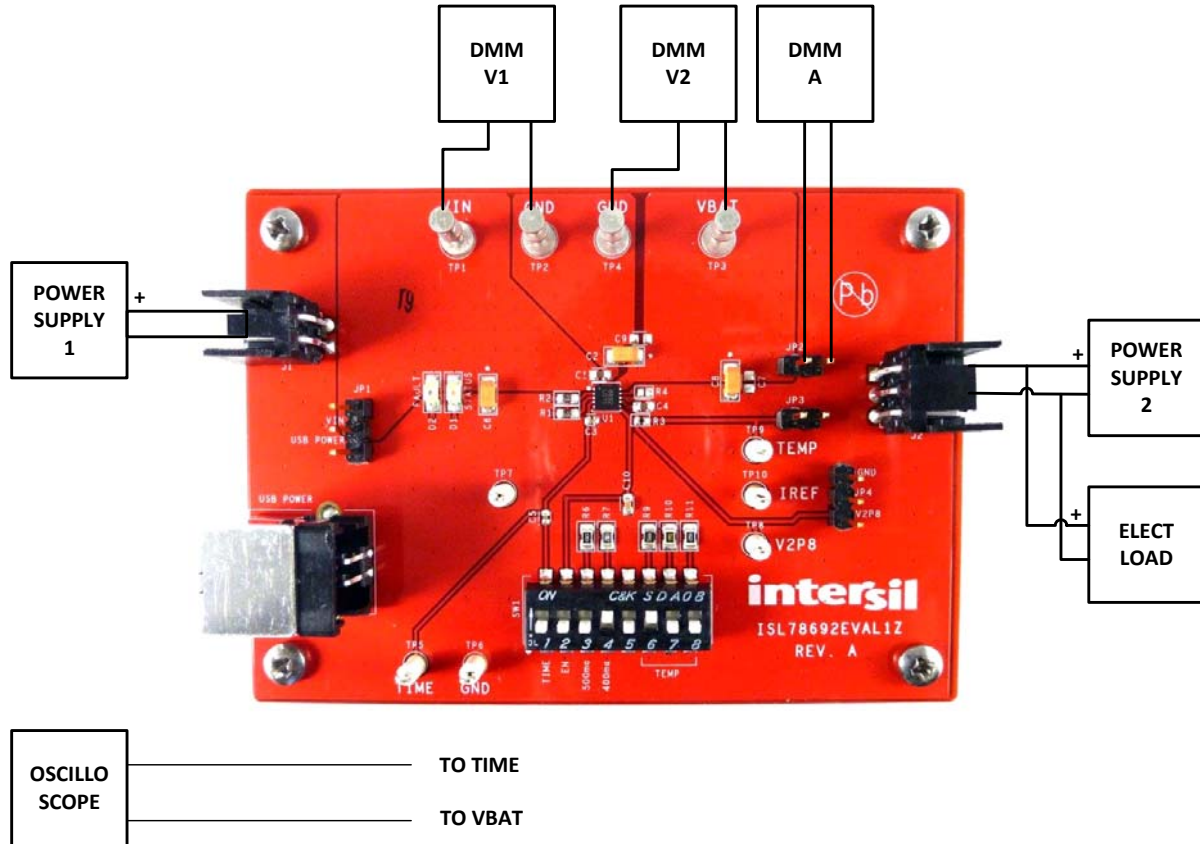
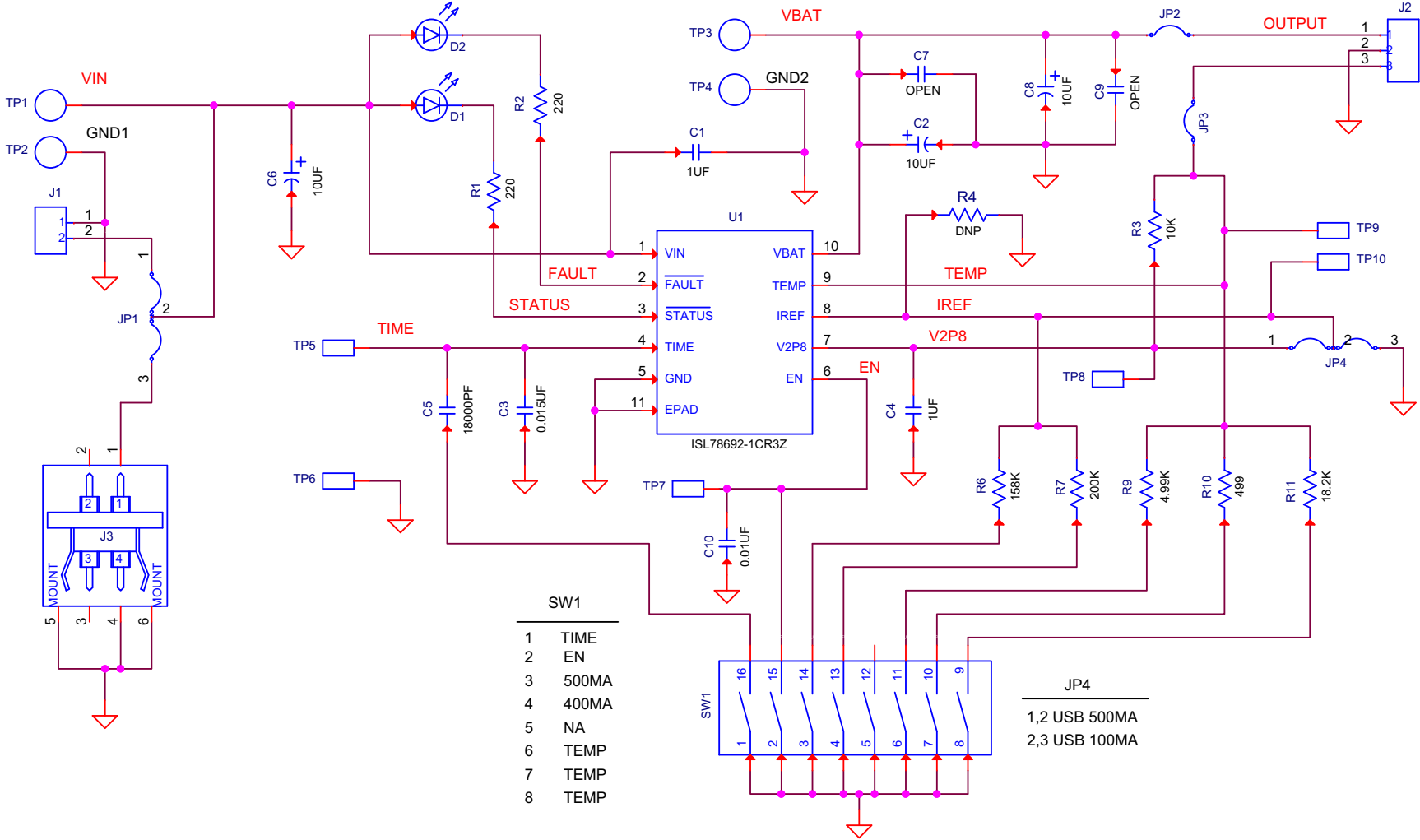

FIGURE 4. CONNECTION OF INSTRUMENTS

Schematic



SW1

1	TIME
2	EN
3	500MA
4	400MA
5	NA
6	TEMP
7	TEMP
8	TEMP

JP4

1,2	USB 500MA
2,3	USB 100MA

Bill of Materials

QTY	UNITS	REFERENCE DESIGNATOR	DESCRIPTION	MANUFACTURER	MANUFACTURER PART NUMBER
1	ea		PWB-PCB, ISL78692EVAL1Z, REVA, ROHS		ISL78692EVAL1ZREVAPCB
2	ea	C1, C4	CAP, SMD, 0603, 1.0µF, 16V, 10%, X7R, ROHS	TDK	C1608X7R1C105K
1	ea	C3	CAP, SMD, 0402, 0.015µF, 16V, 10%, X7R, ROHS	PANASONIC	ECJ-0EB1C153K
1	ea	C5	CAP, SMD, 0402, 0.018µF, 16V, 10%, X7R, ROHS	MURATA	GRM155R71C183KA01D
1	ea	C10	CAP, SMD, 0603, .01µF, 16V, 10%, X7R, ROHS	VENKEL	C0603X7R160-103KNE
0	ea	C7, C9	CAP, SMD, 0603, DNP-PLACE HOLDER, ROHS		
3	ea	C2, C6, C8	CAP-TANT, LOW ESR, SMD, A, 10µF, 16V, 20%, 200mΩ, ROHS	AVX	TCJA106M016R0200
4	ea	TP1-TP4	CONN-TURRET, TERMINAL POST, TH, ROHS	KEYSTONE	1514-2
1	ea	J1	CONN-HEADER, 2P, SHROUDED, 2.54mm, RT.ANGLE, ROHS	AMP/TYCO	2-644803-2
1	ea	J2	CONN-HEADER, 3P,SHROUDED, 2.54mm, RT.ANGLE, ROHS	AMP/TYCO	2-644803-3
1	ea	J3	CONN-TYPE B RECEPTACLE, TH,4 POS, RT.ANGLE, ROHS	AMP/TYCO	292304-1
6	ea	TP5-TP10	CONN-MINI TEST POINT, VERTICAL, WHITE, ROHS	KEYSTONE	5002
2	ea	JP1, JP4	CONN-HEADER, 1x3, BREAKAWY 1X36, 2.54mm, ROHS	BERG/FCI	68000-236HLF
2	ea	JP2, JP3	CONN-HEADER, 1X2, RETENTIVE, 2.54mm, 0.230X 0.120, ROHS"	BERG/FCI	69190-202HLF
1	ea	D2	LED, SMD, 1206, RED, 30mA, 60mW, 17mcd, ROHS	DIALIGHT	597-3111-407F
1	ea	D1	LED, SMD, 1206 ,GREEN, 75mW, 3mcd, Pb-Free	DIALIGHT	597-3311-407F
1	ea	U1	IC-4.1V LI-ION/LI POLYMER CHARGER, 10LD DFN 3X3, ROHS	INTERSIL	ISL78692-1CR3Z
1	ea	R3	RES, SMD, 0402, 10k, 1/16W, 1%, TF, ROHS	PANASONIC	ERJ-2RKF1002X
0	ea	R4	RES, SMD, 0402, DNP, DNP, DNP, TF, ROHS		
2	ea	R1, R2	RES, SMD, 0603, 220Ω, 1/10W, 1%, TF, ROHS	YAGEO	9C06031A2200FKHFT
1	ea	R6	RES, SMD, 0805, 158k, 1/8W, 1%, TF, ROHS	YAGEO	RC0805FR-07158KL
1	ea	R11	RES, SMD, 0805, 18.2k, 1/10W, 1%, TF, ROHS	PANASONIC	ERJ-6ENF1822V
1	ea	R7	RES, SMD, 0805, 200k, 1/8W, 1%, TF, ROHS	VENKEL	CR0805-8W-2003FT
1	ea	R10	RES, SMD, 0805, 499Ω, 1/8W, 1%, TF, ROHS	YAGEO	RC0805FR-07499RL
1	ea	R9	RES, SMD, 0805, 4.99k, 1/8W, 1%, TF, ROHS	PANASONIC	ERJ-6ENF4991V
1	ea	SW1	SWITCH-DIP, SMD, 8POS, TOP SLIDE, SPST, 24V, ROHS	C&K COMPONENTS	SDA08H1SBD
4	ea	Four corners	SCREW, 4-40X1/4in, PAN, SS, PHILLIPS		
4	ea	Four corners	STANDOFF, 4-40X3/4in, F/F, HEX, ALUMINUM, ROHS	KEYSTONE	2204 (.250 OD)

PCB Layout

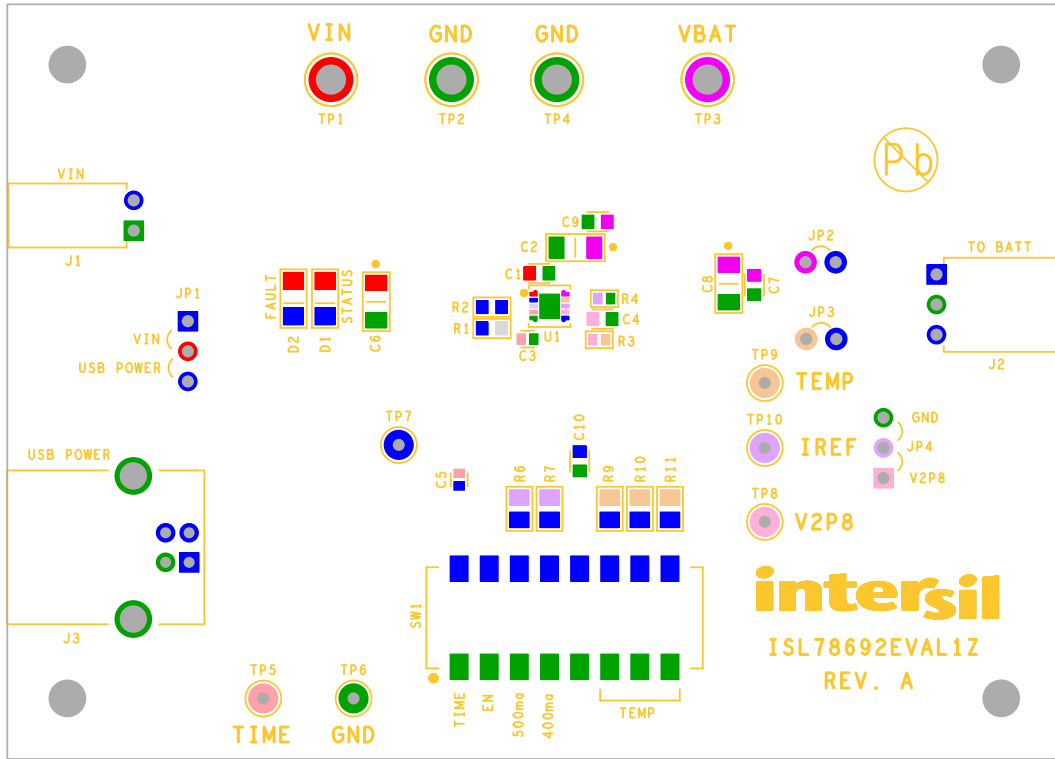

FIGURE 5. SILK LAYER TOP

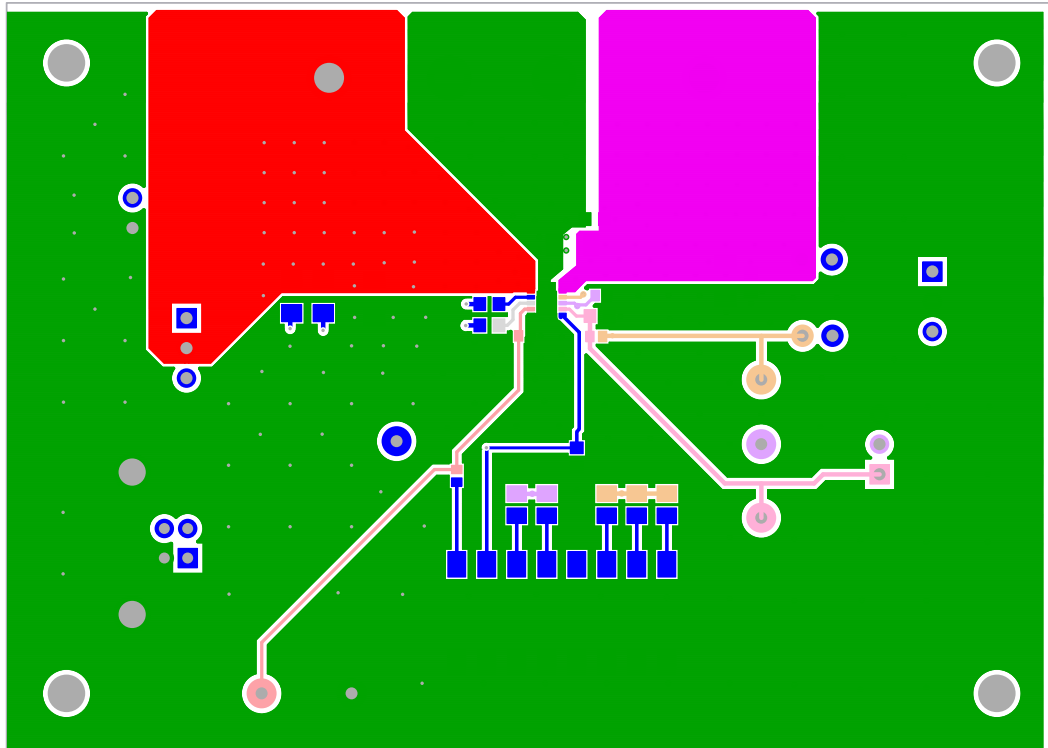

FIGURE 6. TOP LAYER COMPONENT SIDE

PCB Layout (Continued)

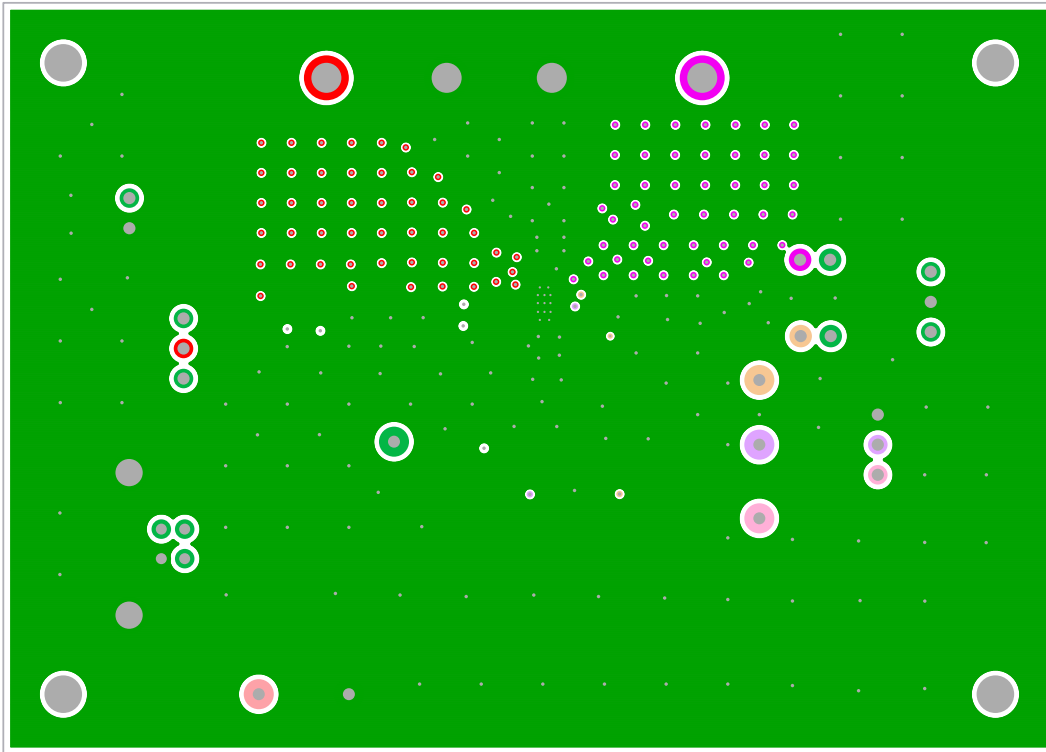

FIGURE 7. INTERNAL (LAYER 2)

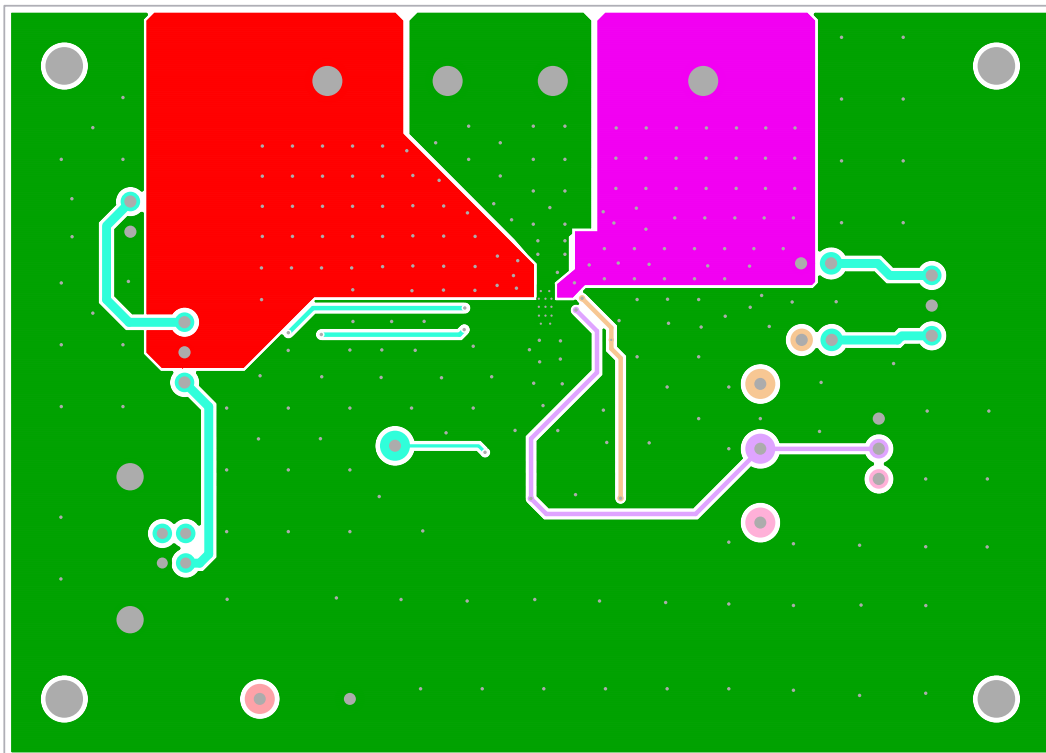

FIGURE 8. INTERNAL (LAYER 3)

PCB Layout (Continued)

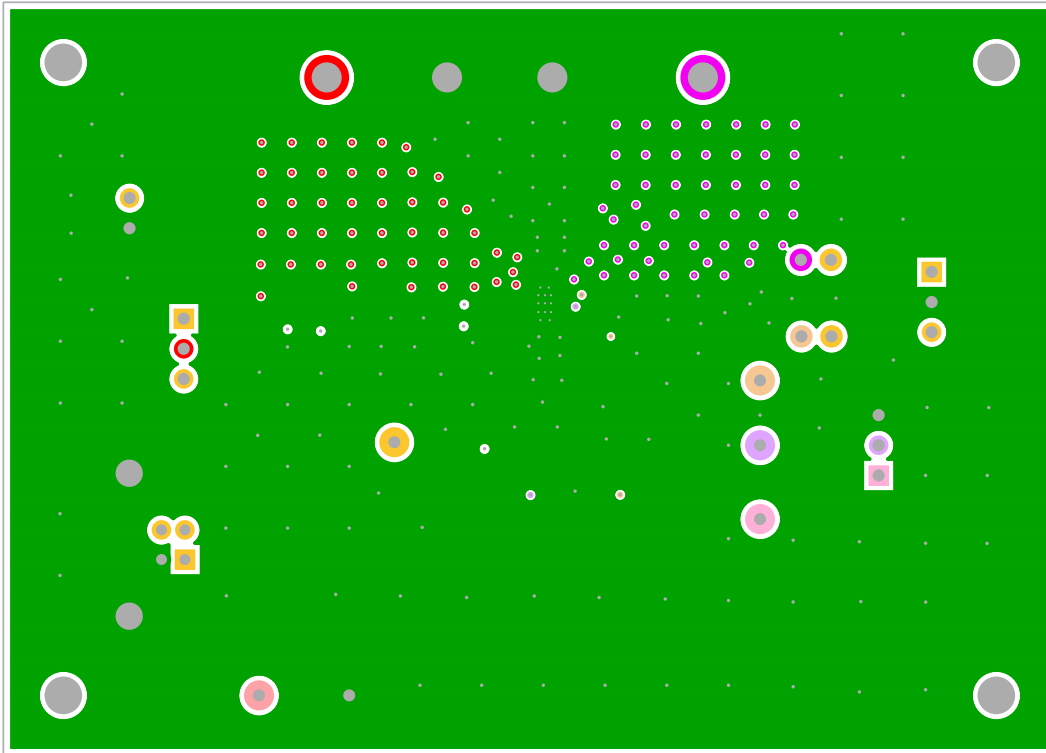

FIGURE 9. BOTTOM LAYER SOLDER SIDE

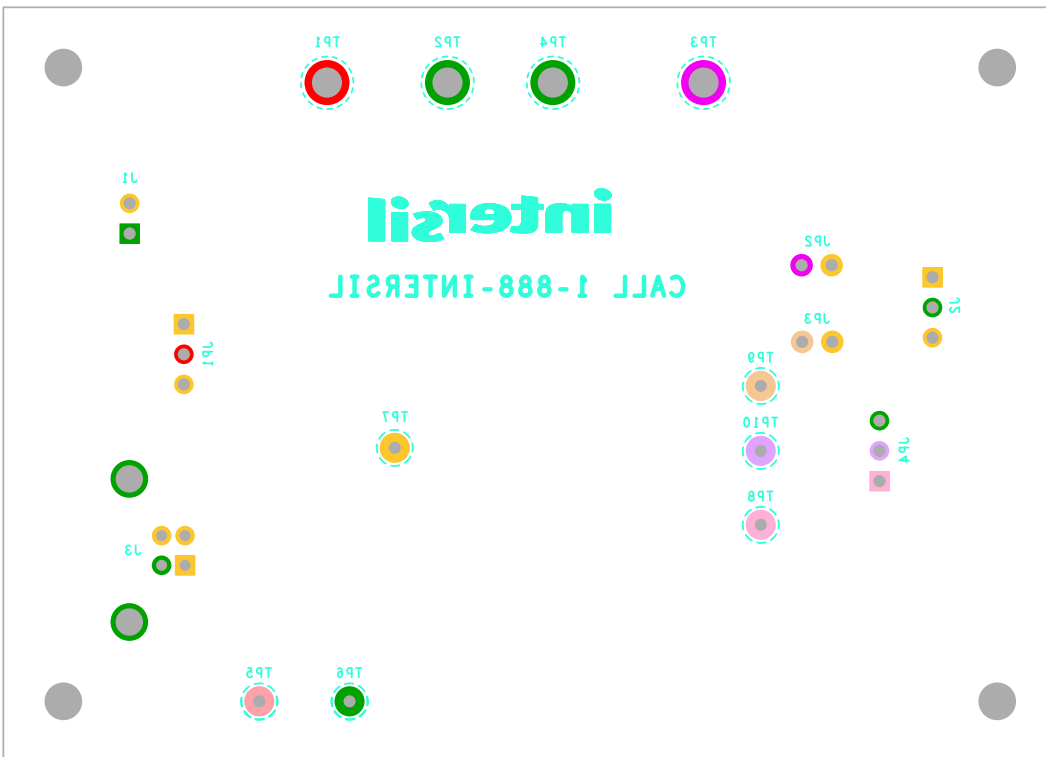
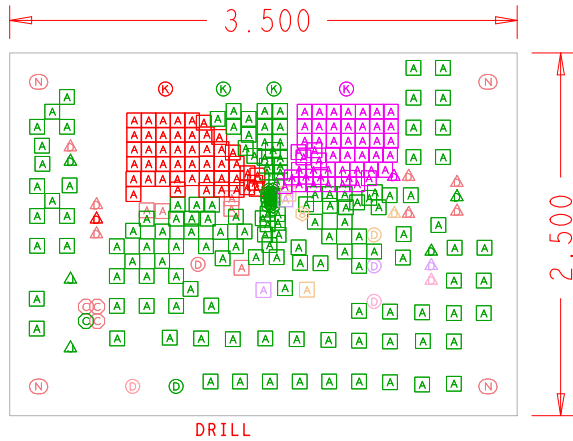
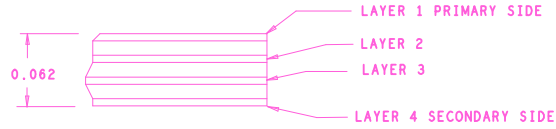

FIGURE 10. SILKSCREEN BOTTOM

PCB Layout (Continued)



DRILL CHART: TOP to BOTTOM			
ALL UNITS ARE IN MILS			
FIGURE	SIZE	PLATED	QTY
⊗	8.0	PLATED	14
⊠	12.0	PLATED	242
⊙	37.0	PLATED	4
⊚	40.0	PLATED	6
△	41.0	PLATED	15
△	91.0	PLATED	2
⊗	100.0	PLATED	4
⊗	125.0	NON-PLATED	4

- NOTES:
1. THIS BOARD IS RoHS COMPLIANT.
 2. PRINTED WIRING BOARD DESIGN AND ACCEPTANCE CRITERIA SHALL BE IAW WITH THE REQUIREMENTS OF IPC-D-275 AND IPC-A-600.
 3. MATERIAL: FR4 (RoHS COMPLIANT), 1 OZ COPPER.
 4. APPLY SOLDER MASK, BOTH SIDES OVER BARE COPPER IAW IPC-SM-840, CLASS 2 (LPI) (INTERSIL RED MASK).
 5. ALL PATTERNS ARE VIEWED FROM THE PRIMARY SIDE LOOKING THROUGH THE BOARD.
 6. UNLESS OTHERWISE SPECIFIED ALL HOLE DIAMETERS ARE AFTER PLATING.
 7. APPLY SILKSCREEN USING WHITE NON-CONDUCTIVE EPOXY BASED INK.
 8. PWB MUST BE 100% ELECTRICALLY TESTED FOR SHORTS AND CONTINUITY. USE NETLIST PROVIDED ISL78691EVALIZA_IPC356.IPC IAW IPC-D-356.
 9. MARK DATE CODE AND MANUFACTURES IDENTIFICATION ON SOLDER SIDE PER IPC-6011 AND IPC-6012.
 10. TOLERANCE ON ALL DRILL HOLES SHALL BE IAW IPC-D-2221 & 2222 UNLESS OTHERWISE SPECIFIED.

FIGURE 11A. PCB AND DRILL SPECIFICATIONS

Typical Performance Curves

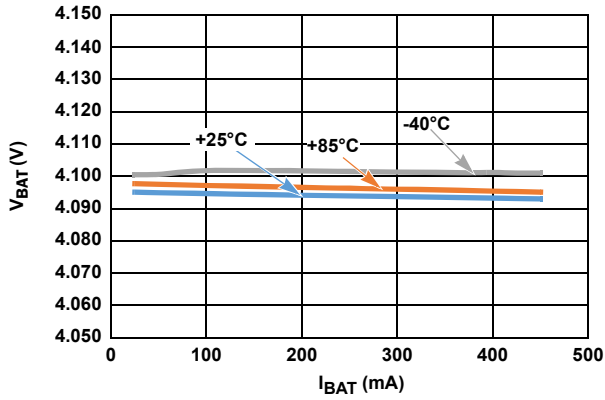

FIGURE 12. VOLTAGE REGULATION vs CHARGE CURRENT

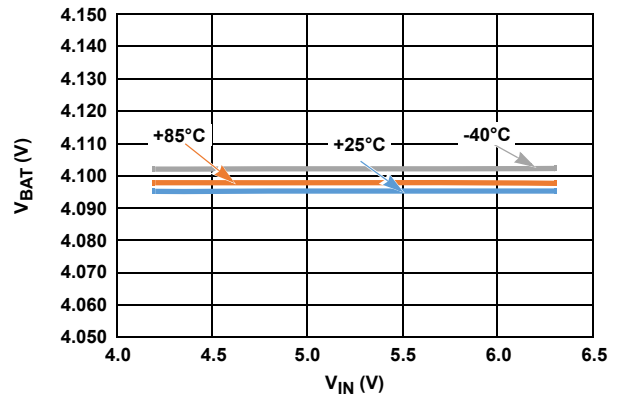

FIGURE 13. NO LOAD VOLTAGE vs TEMPERATURE

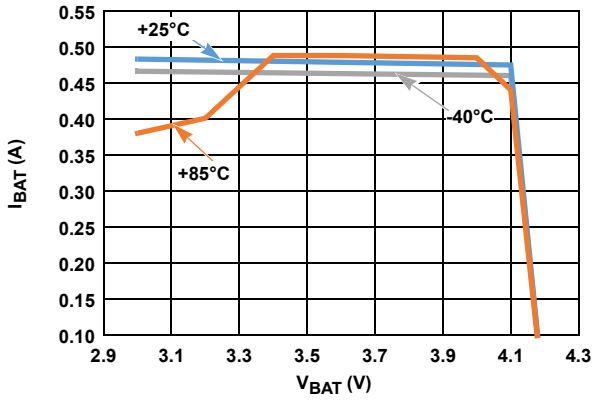

FIGURE 14. CHARGE CURRENT vs OUTPUT VOLTAGE, $R_{IREF} = 158k$

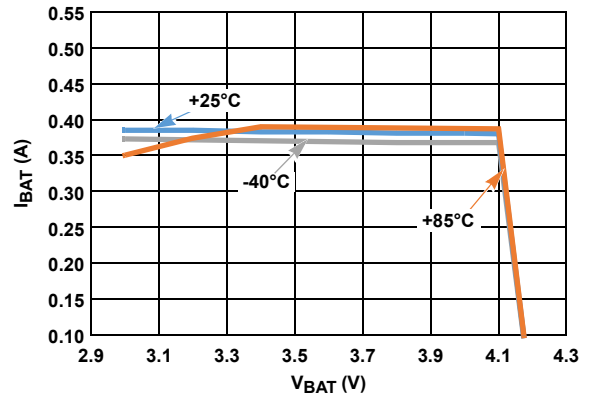

FIGURE 15. CHARGE CURRENT vs OUTPUT VOLTAGE, $R_{IREF} = 200k$

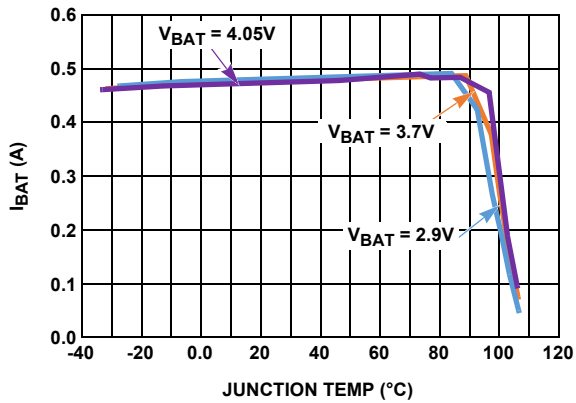

FIGURE 16. CHARGE CURRENT vs JUNCTION TEMPERATURE, $R_{IREF} = 158k$

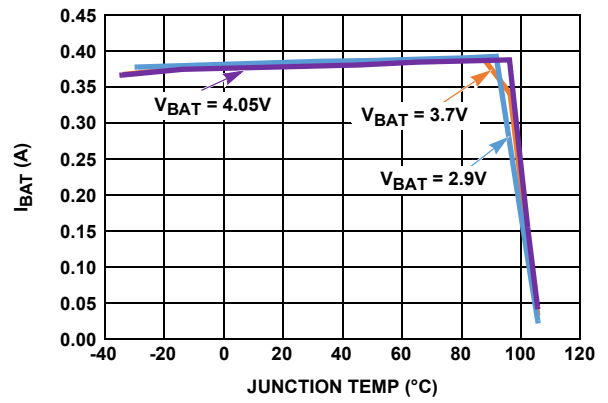

FIGURE 17. CHARGE CURRENT vs JUNCTION TEMPERATURE, $R_{IREF} = 200k$

Typical Performance Curves

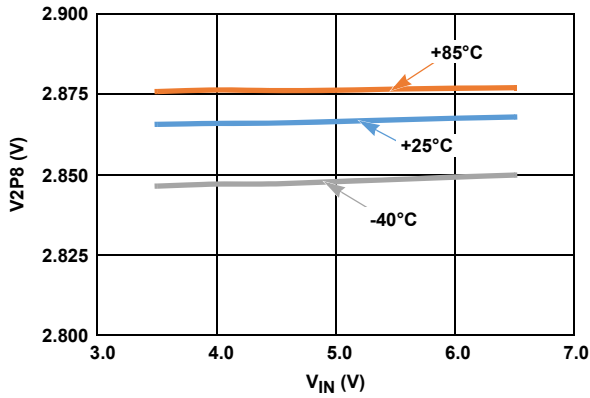

FIGURE 18. V2P8 OUTPUT vs INPUT VOLTAGE AT NO LOAD

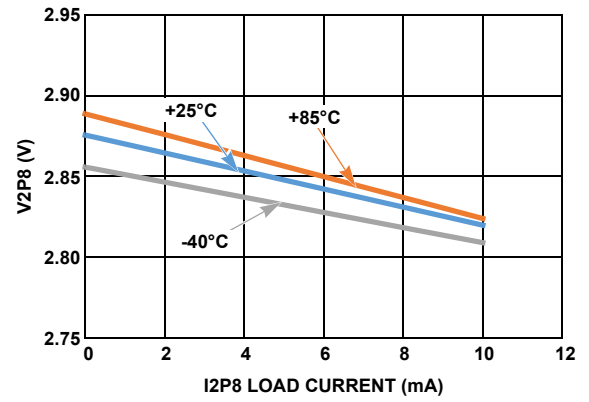

FIGURE 19. V2P8 OUTPUT vs LOAD CURRENT

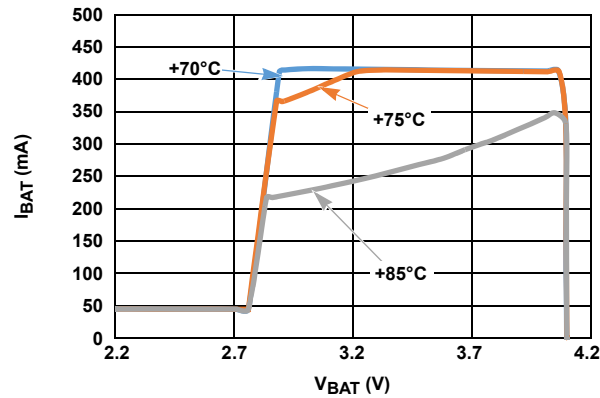

FIGURE 20. V_{BAT} vs I_{BAT} vs AMBIENT TEMPERATURE, R_{IREF} = 200k, V_{IN} = 5.5V, AIR FLOW = 0 LFM, MEASURED ON THE ISL78692EVAL1Z BOARD

Notice

1. Descriptions of circuits, software and other related information in this document are provided only to illustrate the operation of semiconductor products and application examples. You are fully responsible for the incorporation or any other use of the circuits, software, and information in the design of your product or system. Renesas Electronics disclaims any and all liability for any losses and damages incurred by you or third parties arising from the use of these circuits, software, or information.
2. Renesas Electronics hereby expressly disclaims any warranties against and liability for infringement or any other claims involving patents, copyrights, or other intellectual property rights of third parties, by or arising from the use of Renesas Electronics products or technical information described in this document, including but not limited to, the product data, drawings, charts, programs, algorithms, and application examples.
3. No license, express, implied or otherwise, is granted hereby under any patents, copyrights or other intellectual property rights of Renesas Electronics or others.
4. You shall not alter, modify, copy, or reverse engineer any Renesas Electronics product, whether in whole or in part. Renesas Electronics disclaims any and all liability for any losses or damages incurred by you or third parties arising from such alteration, modification, copying or reverse engineering.
5. Renesas Electronics products are classified according to the following two quality grades: "Standard" and "High Quality". The intended applications for each Renesas Electronics product depends on the product's quality grade, as indicated below.
"Standard": Computers; office equipment; communications equipment; test and measurement equipment; audio and visual equipment; home electronic appliances; machine tools; personal electronic equipment; industrial robots; etc.
"High Quality": Transportation equipment (automobiles, trains, ships, etc.); traffic control (traffic lights); large-scale communication equipment; key financial terminal systems; safety control equipment; etc.
Unless expressly designated as a high reliability product or a product for harsh environments in a Renesas Electronics data sheet or other Renesas Electronics document, Renesas Electronics products are not intended or authorized for use in products or systems that may pose a direct threat to human life or bodily injury (artificial life support devices or systems; surgical implantations; etc.), or may cause serious property damage (space system; undersea repeaters; nuclear power control systems; aircraft control systems; key plant systems; military equipment; etc.). Renesas Electronics disclaims any and all liability for any damages or losses incurred by you or any third parties arising from the use of any Renesas Electronics product that is inconsistent with any Renesas Electronics data sheet, user's manual or other Renesas Electronics document.
6. When using Renesas Electronics products, refer to the latest product information (data sheets, user's manuals, application notes, "General Notes for Handling and Using Semiconductor Devices" in the reliability handbook, etc.), and ensure that usage conditions are within the ranges specified by Renesas Electronics with respect to maximum ratings, operating power supply voltage range, heat dissipation characteristics, installation, etc. Renesas Electronics disclaims any and all liability for any malfunctions, failure or accident arising out of the use of Renesas Electronics products outside of such specified ranges.
7. Although Renesas Electronics endeavors to improve the quality and reliability of Renesas Electronics products, semiconductor products have specific characteristics, such as the occurrence of failure at a certain rate and malfunctions under certain use conditions. Unless designated as a high reliability product or a product for harsh environments in a Renesas Electronics data sheet or other Renesas Electronics document, Renesas Electronics products are not subject to radiation resistance design. You are responsible for implementing safety measures to guard against the possibility of bodily injury, injury or damage caused by fire, and/or danger to the public in the event of a failure or malfunction of Renesas Electronics products, such as safety design for hardware and software, including but not limited to redundancy, fire control and malfunction prevention, appropriate treatment for aging degradation or any other appropriate measures. Because the evaluation of microcomputer software alone is very difficult and impractical, you are responsible for evaluating the safety of the final products or systems manufactured by you.
8. Please contact a Renesas Electronics sales office for details as to environmental matters such as the environmental compatibility of each Renesas Electronics product. You are responsible for carefully and sufficiently investigating applicable laws and regulations that regulate the inclusion or use of controlled substances, including without limitation, the EU RoHS Directive, and using Renesas Electronics products in compliance with all these applicable laws and regulations. Renesas Electronics disclaims any and all liability for damages or losses occurring as a result of your noncompliance with applicable laws and regulations.
9. Renesas Electronics products and technologies shall not be used for or incorporated into any products or systems whose manufacture, use, or sale is prohibited under any applicable domestic or foreign laws or regulations. You shall comply with any applicable export control laws and regulations promulgated and administered by the governments of any countries asserting jurisdiction over the parties or transactions.
10. It is the responsibility of the buyer or distributor of Renesas Electronics products, or any other party who distributes, disposes of, or otherwise sells or transfers the product to a third party, to notify such third party in advance of the contents and conditions set forth in this document.
11. This document shall not be reprinted, reproduced or duplicated in any form, in whole or in part, without prior written consent of Renesas Electronics.
12. Please contact a Renesas Electronics sales office if you have any questions regarding the information contained in this document or Renesas Electronics products.
(Note 1) "Renesas Electronics" as used in this document means Renesas Electronics Corporation and also includes its directly or indirectly controlled subsidiaries.
(Note 2) "Renesas Electronics product(s)" means any product developed or manufactured by or for Renesas Electronics.

(Rev.4.0-1 November 2017)



SALES OFFICES

Renesas Electronics Corporation

<http://www.renesas.com>

Refer to "<http://www.renesas.com/>" for the latest and detailed information.

Renesas Electronics America Inc.
1001 Murphy Ranch Road, Milpitas, CA 95035, U.S.A.
Tel: +1-408-432-8888, Fax: +1-408-434-5351

Renesas Electronics Canada Limited
9251 Yonge Street, Suite 8309 Richmond Hill, Ontario Canada L4C 9T3
Tel: +1-905-237-2004

Renesas Electronics Europe Limited
Dukes Meadow, Millboard Road, Bourne End, Buckinghamshire, SL8 5FH, U.K.
Tel: +44-1628-651-700, Fax: +44-1628-651-804

Renesas Electronics Europe GmbH
Arcadiastrasse 10, 40472 Düsseldorf, Germany
Tel: +49-211-6503-0, Fax: +49-211-6503-1327

Renesas Electronics (China) Co., Ltd.
Room 1709 Quantum Plaza, No.27 ZhichunLu, Haidian District, Beijing, 100191 P. R. China
Tel: +86-10-8235-1155, Fax: +86-10-8235-7679

Renesas Electronics (Shanghai) Co., Ltd.
Unit 301, Tower A, Central Towers, 555 Langao Road, Putuo District, Shanghai, 200333 P. R. China
Tel: +86-21-2226-0888, Fax: +86-21-2226-0999

Renesas Electronics Hong Kong Limited
Unit 1601-1611, 16/F., Tower 2, Grand Century Place, 193 Prince Edward Road West, Mongkok, Kowloon, Hong Kong
Tel: +852-2265-6688, Fax: +852-2886-9022

Renesas Electronics Taiwan Co., Ltd.
13F, No. 363, Fu Shing North Road, Taipei 10543, Taiwan
Tel: +886-2-8175-9600, Fax: +886-2-8175-9670

Renesas Electronics Singapore Pte. Ltd.
80 Bendemeer Road, Unit #06-02 Hyflux Innovation Centre, Singapore 339949
Tel: +65-6213-0200, Fax: +65-6213-0300

Renesas Electronics Malaysia Sdn.Bhd.
Unit 1207, Block B, Menara Amcorp, Amcorp Trade Centre, No. 18, Jln Persiaran Barat, 46050 Petaling Jaya, Selangor Darul Ehsan, Malaysia
Tel: +60-3-7955-9390, Fax: +60-3-7955-9510

Renesas Electronics India Pvt. Ltd.
No.777C, 100 Feet Road, HAL 2nd Stage, Indiranagar, Bangalore 560 038, India
Tel: +91-80-67208700, Fax: +91-80-67208777

Renesas Electronics Korea Co., Ltd.
17F, KAMCO Yangjae Tower, 262, Gangnam-daero, Gangnam-gu, Seoul, 06265 Korea
Tel: +82-2-558-3737, Fax: +82-2-558-5338