

# ISL81601DEMO2Z

## User's Manual: MCU Part and GUI

### Industrial Analog and Power

All information contained in these materials, including products and product specifications, represents information on the product at the time of publication and is subject to change by Renesas Electronics Corp. without notice. Please review the latest information published by Renesas Electronics Corp. through various means, including the Renesas Electronics Corp. website (<http://www.renesas.com>).

ISL81601DEMO2Z

MCU Part and GUI Software

The RL78/G14 MCU outputs four channels of PWM to control the input voltage, input current, output voltage, and output current of the ISL81601DEMO2Z demonstration board and uses two channels of A/D sampling to monitor the output voltage and the input voltage to realize the overvoltage and undervoltage protections. It gets the measured values in high-precision of the input voltage, input current, output voltage, and output current from two ISL28022 chips by IIC. The RL78/G14 also provides the communication with the GUI.

The GUI named "ISL81601DEMO2Z.exe" helps you control and monitor the ISL81601DEMO2Z board intuitively.

Specifications

Table 1. MCU Rating

Parameter	Rating
PWM Frequency	100kHz
MCU Voltage	3.3V

Related Literature

For a full list of related documents, visit our website:

- [ISL81601](#) device page

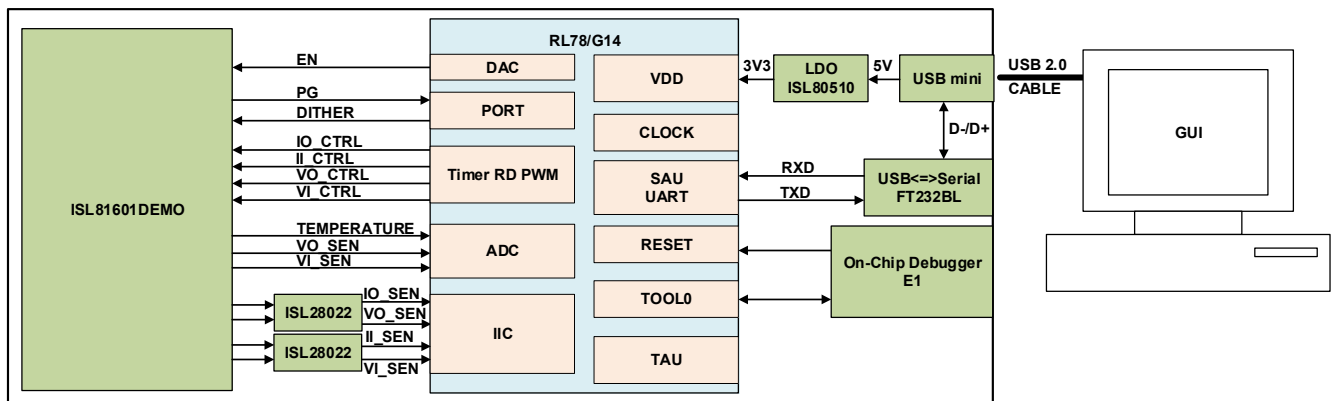

Figure 1. Block Diagram

# 1. Quick GUI Setup Guide

1. Set up the hardware as shown in [Figure 2](#).

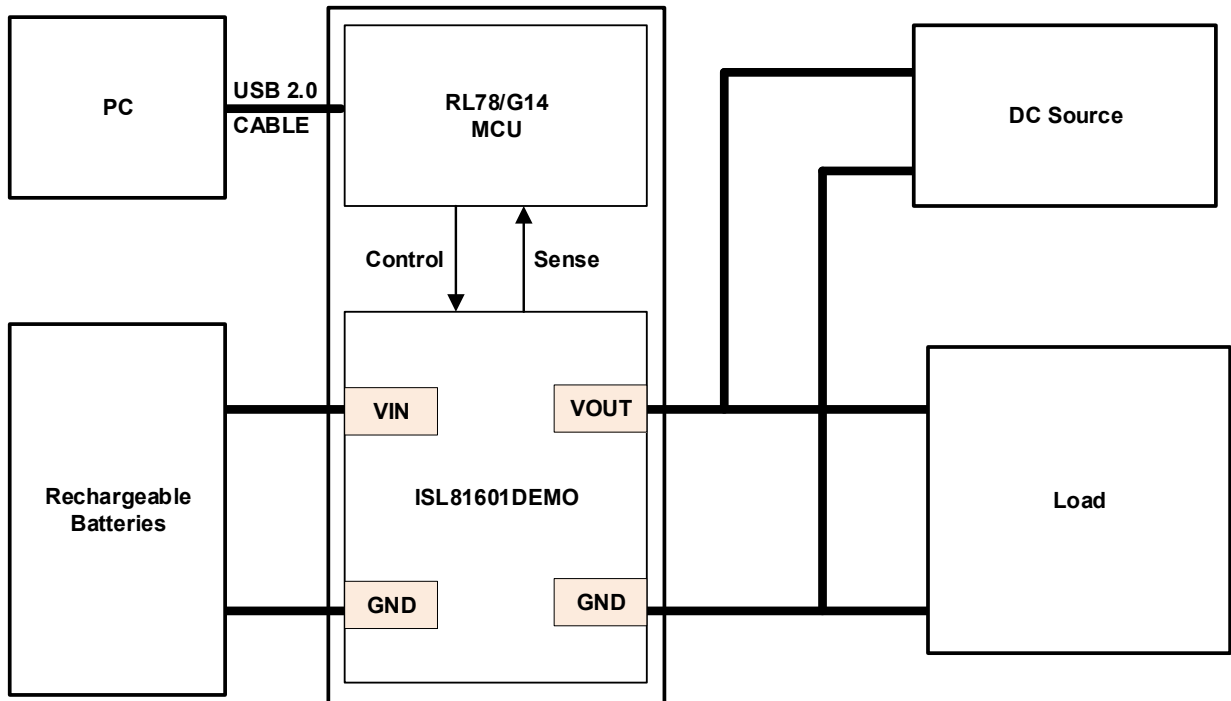

Figure 2. Hardware Connection

2. When the board is connected to the PC through the USB cable, start the GUI program.
3. Click on **CONNECT**.

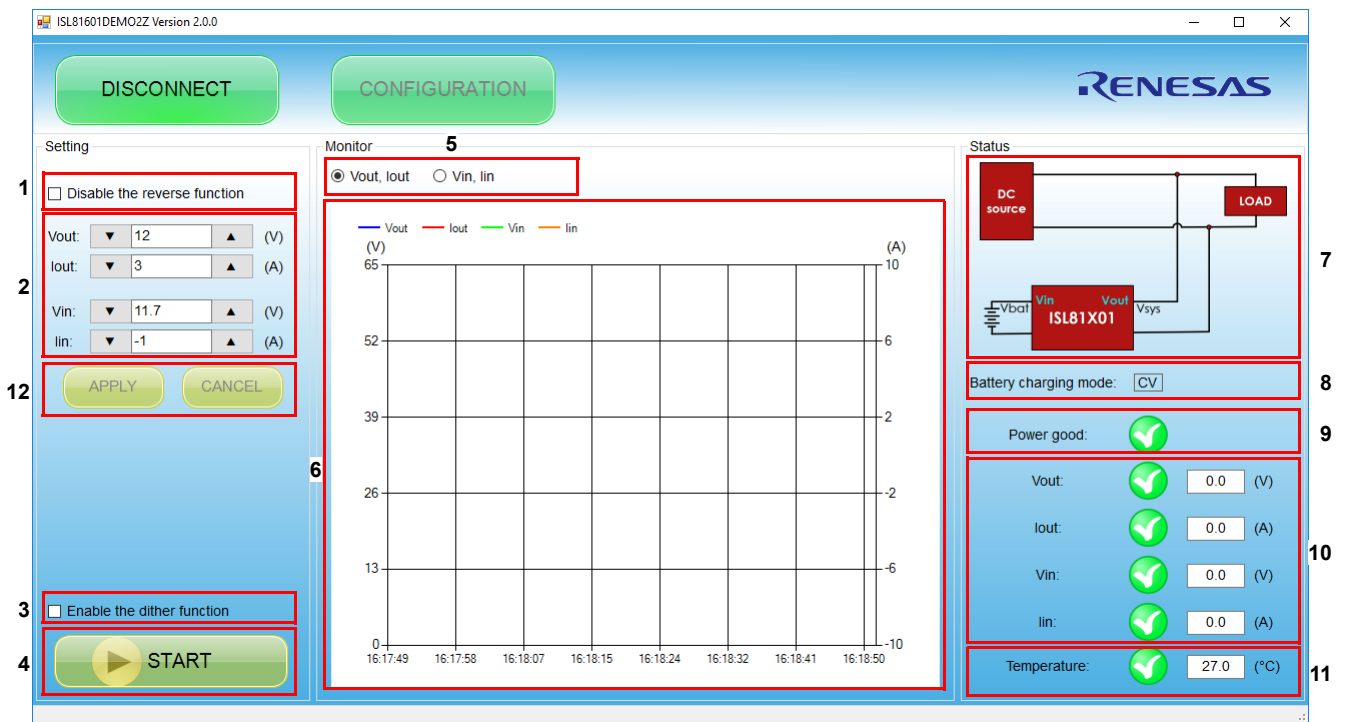
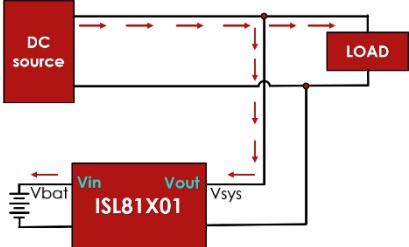
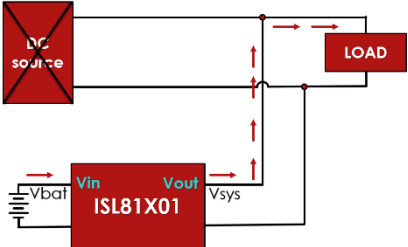





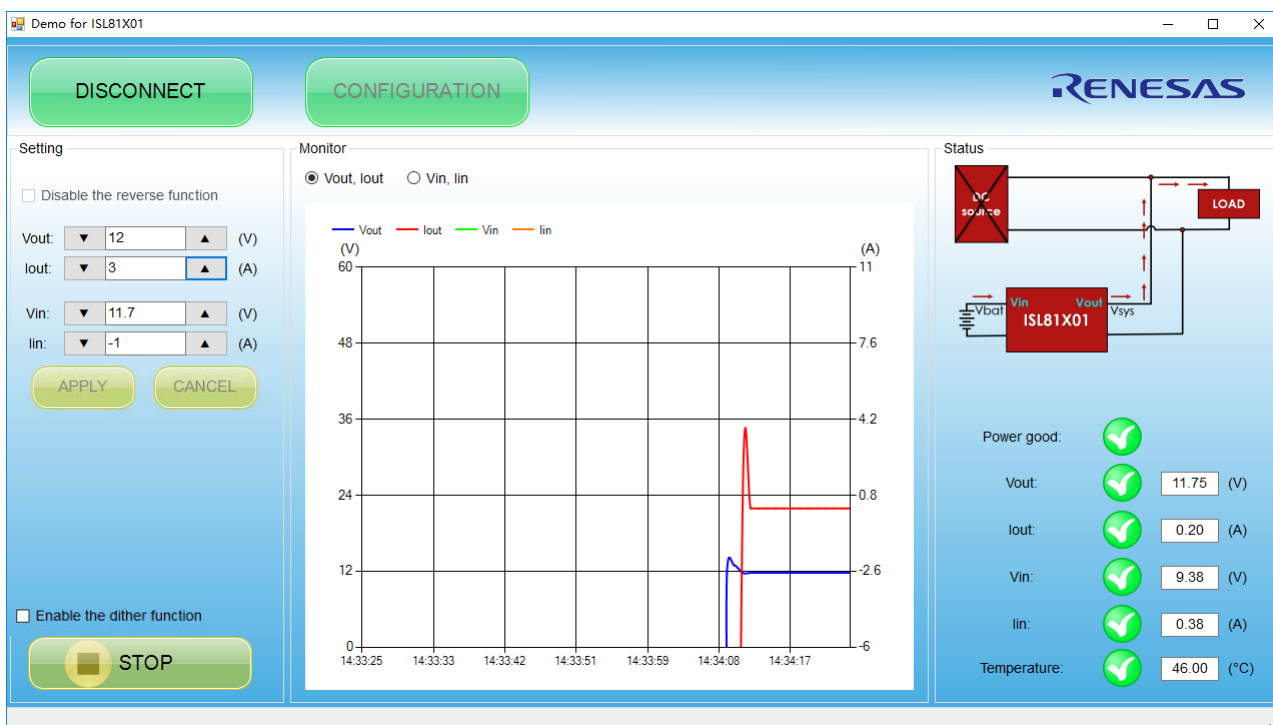

Figure 3.

Number	Description
1	Unchecked: Enables the reverse function. Checked: Disables the reverse function. <b>Note:</b> This function only can be changed when the ISL81601DEMO2Z is disabled.
2	The setting values. Vout: Sets the object value for the constant-voltage regulator on terminal J4 (Vout). Iout: Sets the threshold for the constant-current OCP on terminal J4 (Vout). Vin: Sets the threshold for the constant-voltage OVP on terminal J1 (Vin). Iin: Sets the threshold for the constant-current OCP on terminal J1 (Vin).
3	Checked: Enable the frequency dither function. Unchecked: Disable the frequency dither function.
4	Click <b>START</b> to enable the ISL81601DEMO2Z board. Then the button turns to <b>STOP</b> . Click <b>STOP</b> to disable the ISL81601DEMO2Z board. Then the button turns to <b>START</b> .
5	<b>Vout, Iout</b> checked: Displays the output voltage and output current waveforms in the chart. <b>Vin, Iin</b> checked: Displays the input voltage and input current waveforms in the chart.
6	Displays the voltage and current waveforms.
7	Show the current direction. <div style="display: flex; justify-content: space-around; align-items: center;">  <span>or</span>  </div>
8	Displays the charging status of the batteries: "CC" or "CV".
9	 : Power good  : Power fail
10	Displays the real-time output voltage, output current, input voltage, and input current values.  : The detection value is within the setting range.  : The detection value is out of the setting range.
11	Displays the real-time temperature value.  : The temperature is within the range from -40°C to +85°C.  : The temperature is out of the range from -40°C to +85°C.
12	During the start operation, change the setting value with the keyboard and click the <b>APPLY</b> button, the control value is changed by step automatically.

4. After configuring the settings, click **START**.



5. Click **STOP**. A file named *ISL81601DEMO2Z\_yyyymmddhhmmss.csv* is created in the directory where this program is located. This file logs the run time information.

Time	Set Vout (V)	Actual Vout (V)	Set Iout (A)	Actual Iout (A)	Set Vin (V)	Actual Vin (V)	Set Iin (A)	Actual Iin (A)	Temp (degC)
2018/9/5 14:34:09	12	11.65	3	-96.41	11.7	9.45	-1	-69.69	247
2018/9/5 14:34:10	12	12.94	3	-48.39	11.7	9.18	-1	-34.69	46
2018/9/5 14:34:11	12	11.73	3	0.2	11.7	9.38	-1	0.3	46
2018/9/5 14:34:12	12	11.75	3	0.2	11.7	9.38	-1	0.3	46
2018/9/5 14:34:13	12	11.75	3	0.2	11.7	9.38	-1	0.3	46
2018/9/5 14:34:14	12	11.75	3	0.2	11.7	9.38	-1	0.3	46
2018/9/5 14:34:15	12	11.75	3	0.2	11.7	9.38	-1	0.3	46
2018/9/5 14:34:16	12	11.75	3	0.2	11.7	9.38	-1	0.3	46
2018/9/5 14:34:17	12	11.75	3	0.2	11.7	9.38	-1	0.3	46
2018/9/5 14:34:18	12	11.75	3	0.2	11.7	9.38	-1	0.3	46
2018/9/5 14:34:19	12	11.75	3	0.2	11.7	9.38	-1	0.3	46
2018/9/5 14:34:20	12	11.75	3	0.2	11.7	9.38	-1	0.3	46
2018/9/5 14:34:21	12	11.75	3	0.2	11.7	9.38	-1	0.3	46
2018/9/5 14:34:22	12	11.75	3	0.2	11.7	9.38	-1	0.3	46
2018/9/5 14:34:23	12	11.75	3	0.2	11.7	9.38	-1	0.3	46
2018/9/5 14:34:24	12	11.75	3	0.2	11.7	9.38	-1	0.38	46
2018/9/5 14:34:25	12	11.75	3	0.2	11.7	9.38	-1	0.3	46
2018/9/5 14:34:26	12	11.75	3	0.2	11.7	9.38	-1	0.3	46
2018/9/5 14:34:27	12	11.75	3	0.2	11.7	9.38	-1	0.3	46
2018/9/5 14:34:28	12	11.75	3	0.2	11.7	9.38	-1	0.3	46
2018/9/5 14:34:29	12	11.75	3	0.2	11.7	9.38	-1	0.3	46
2018/9/5 14:34:30	12	11.75	3	0.2	11.7	9.38	-1	0.3	46
2018/9/5 14:34:31	12	11.75	3	0.2	11.7	9.38	-1	0.3	46
2018/9/5 14:34:32	12	11.75	3	0.2	11.7	9.38	-1	0.3	46
2018/9/5 14:34:33	12	11.75	3	0.2	11.7	9.38	-1	0.3	46

---

## 2. Revision History

Rev.	Date	Description
1.00	Oct.7.19	Initial release

## General Precautions in the Handling of Microprocessing Unit and Microcontroller Unit Products

The following usage notes are applicable to all Microprocessing unit and Microcontroller unit products from Renesas. For detailed usage notes on the products covered by this document, refer to the relevant sections of the document as well as any technical updates that have been issued for the products.

### 1. Handling of Unused Pins

Handle unused pins in accordance with the directions given under Handling of Unused Pins in the manual.

- The input pins of CMOS products are generally in the high-impedance state. In operation with an unused pin in the open-circuit state, extra electromagnetic noise is induced in the vicinity of LSI, an associated shoot-through current flows internally, and malfunctions occur due to the false recognition of the pin state as an input signal become possible. Unused pins should be handled as described under Handling of Unused Pins in the manual.

### 2. Processing at Power-on

The state of the product is undefined at the moment when power is supplied.

- The states of internal circuits in the LSI are indeterminate and the states of register settings and pins are undefined at the moment when power is supplied.

In a finished product where the reset signal is applied to the external reset pin, the states of pins are not guaranteed from the moment when power is supplied until the reset process is completed.

In a similar way, the states of pins in a product that is reset by an on-chip power-on reset function are not guaranteed from the moment when power is supplied until the power reaches the level at which resetting has been specified.

### 3. Prohibition of Access to Reserved Addresses

Access to reserved addresses is prohibited.

- The reserved addresses are provided for the possible future expansion of functions. Do not access these addresses; the correct operation of LSI is not guaranteed if they are accessed.

### 4. Clock Signals

After applying a reset, only release the reset line after the operating clock signal has become stable. When switching the clock signal during program execution, wait until the target clock signal has stabilized.

- When the clock signal is generated with an external resonator (or from an external oscillator) during a reset, ensure that the reset line is only released after full stabilization of the clock signal. Moreover, when switching to a clock signal produced with an external resonator (or by an external oscillator) while program execution is in progress, wait until the target clock signal is stable.

### 5. Differences between Products

Before changing from one product to another, i.e. to a product with a different part number, confirm that the change will not lead to problems.

- The characteristics of Microprocessing unit or Microcontroller unit products in the same group but having a different part number may differ in terms of the internal memory capacity, layout pattern, and other factors, which can affect the ranges of electrical characteristics, such as characteristic values, operating margins, immunity to noise, and amount of radiated noise. When changing to a product with a different part number, implement a system-evaluation test for the given product.

## Notice

1. Descriptions of circuits, software and other related information in this document are provided only to illustrate the operation of semiconductor products and application examples. You are fully responsible for the incorporation or any other use of the circuits, software, and information in the design of your product or system. Renesas Electronics disclaims any and all liability for any losses and damages incurred by you or third parties arising from the use of these circuits, software, or information.
2. Renesas Electronics hereby expressly disclaims any warranties against and liability for infringement or any other claims involving patents, copyrights, or other intellectual property rights of third parties, by or arising from the use of Renesas Electronics products or technical information described in this document, including but not limited to, the product data, drawings, charts, programs, algorithms, and application examples.
3. No license, express, implied or otherwise, is granted hereby under any patents, copyrights or other intellectual property rights of Renesas Electronics or others.
4. You shall not alter, modify, copy, or reverse engineer any Renesas Electronics product, whether in whole or in part. Renesas Electronics disclaims any and all liability for any losses or damages incurred by you or third parties arising from such alteration, modification, copying or reverse engineering.
5. Renesas Electronics products are classified according to the following two quality grades: "Standard" and "High Quality". The intended applications for each Renesas Electronics product depends on the product's quality grade, as indicated below.
  - "Standard": Computers; office equipment; communications equipment; test and measurement equipment; audio and visual equipment; home electronic appliances; machine tools; personal electronic equipment; industrial robots; etc.
  - "High Quality": Transportation equipment (automobiles, trains, ships, etc.); traffic control (traffic lights); large-scale communication equipment; key financial terminal systems; safety control equipment; etc.Unless expressly designated as a high reliability product or a product for harsh environments in a Renesas Electronics data sheet or other Renesas Electronics document, Renesas Electronics products are not intended or authorized for use in products or systems that may pose a direct threat to human life or bodily injury (artificial life support devices or systems; surgical implantations; etc.), or may cause serious property damage (space system; undersea repeaters; nuclear power control systems; aircraft control systems; key plant systems; military equipment; etc.). Renesas Electronics disclaims any and all liability for any damages or losses incurred by you or any third parties arising from the use of any Renesas Electronics product that is inconsistent with any Renesas Electronics data sheet, user's manual or other Renesas Electronics document.
6. When using Renesas Electronics products, refer to the latest product information (data sheets, user's manuals, application notes, "General Notes for Handling and Using Semiconductor Devices" in the reliability handbook, etc.), and ensure that usage conditions are within the ranges specified by Renesas Electronics with respect to maximum ratings, operating power supply voltage range, heat dissipation characteristics, installation, etc. Renesas Electronics disclaims any and all liability for any malfunctions, failure or accident arising out of the use of Renesas Electronics products outside of such specified ranges.
7. Although Renesas Electronics endeavors to improve the quality and reliability of Renesas Electronics products, semiconductor products have specific characteristics, such as the occurrence of failure at a certain rate and malfunctions under certain use conditions. Unless designated as a high reliability product or a product for harsh environments in a Renesas Electronics data sheet or other Renesas Electronics document, Renesas Electronics products are not subject to radiation resistance design. You are responsible for implementing safety measures to guard against the possibility of bodily injury, injury or damage caused by fire, and/or danger to the public in the event of a failure or malfunction of Renesas Electronics products, such as safety design for hardware and software, including but not limited to redundancy, fire control and malfunction prevention, appropriate treatment for aging degradation or any other appropriate measures. Because the evaluation of microcomputer software alone is very difficult and impractical, you are responsible for evaluating the safety of the final products or systems manufactured by you.
8. Please contact a Renesas Electronics sales office for details as to environmental matters such as the environmental compatibility of each Renesas Electronics product. You are responsible for carefully and sufficiently investigating applicable laws and regulations that regulate the inclusion or use of controlled substances, including without limitation, the EU RoHS Directive, and using Renesas Electronics products in compliance with all these applicable laws and regulations. Renesas Electronics disclaims any and all liability for damages or losses occurring as a result of your noncompliance with applicable laws and regulations.
9. Renesas Electronics products and technologies shall not be used for or incorporated into any products or systems whose manufacture, use, or sale is prohibited under any applicable domestic or foreign laws or regulations. You shall comply with any applicable export control laws and regulations promulgated and administered by the governments of any countries asserting jurisdiction over the parties or transactions.
10. It is the responsibility of the buyer or distributor of Renesas Electronics products, or any other party who distributes, disposes of, or otherwise sells or transfers the product to a third party, to notify such third party in advance of the contents and conditions set forth in this document.
11. This document shall not be reprinted, reproduced or duplicated in any form, in whole or in part, without prior written consent of Renesas Electronics.
12. Please contact a Renesas Electronics sales office if you have any questions regarding the information contained in this document or Renesas Electronics products.

(Note1) "Renesas Electronics" as used in this document means Renesas Electronics Corporation and also includes its directly or indirectly controlled subsidiaries.

(Note2) "Renesas Electronics product(s)" means any product developed or manufactured by or for Renesas Electronics.

(Rev.4.0-1 November 2017)

## Corporate Headquarters

TOYOSU FORESIA, 3-2-24 Toyosu,  
Koto-ku, Tokyo 135-0061, Japan  
[www.renesas.com](http://www.renesas.com)

## Contact Information

For further information on a product, technology, the most up-to-date version of a document, or your nearest sales office, please visit:  
[www.renesas.com/contact/](http://www.renesas.com/contact/)

## Trademarks

Renesas and the Renesas logo are trademarks of Renesas Electronics Corporation. All trademarks and registered trademarks are the property of their respective owners.



ISL81601DEMO2Z