

## ISL81805EVAL2Z

The ISL81805EVAL2Z dual-output evaluation board (shown in [Figure 4](#)) features the [ISL81805](#), an 80V high voltage dual synchronous boost controller that offers external soft-start, independent enable functions, and integrates UV/OV/OC/OT protection. A programmable switching frequency ranging from 100kHz to 1MHz helps to optimize inductor size while the strong gate driver delivers up to 3A for Channel 1 and 5A for Channel 2.

### Specifications

The ISL81805EVAL2Z dual output evaluation board is designed for high output voltage applications. The current rating of the ISL81805EVAL2Z is limited by the FETs and inductor selected. The ISL81805EVAL2Z electrical ratings listed in [Table 1](#).

**Table 1. ISL81805EVAL2Z Electrical Ratings**

Parameter	Rating
Input Voltage 1	9V to 36V
Input Voltage 2	9V to 20V
Switching Freq	200kHz
Output Voltage 1	48V
Output Current 1	3A
Output Voltage 2	24V
Output Current 2	5A
OCP Set Point 1 (input average)	Minimum 13.8A at ambient room temperature
OCP Set Point 2 (input average)	Minimum 12.6A at ambient room temperature

### Features

- Wide input range: 9V to 36V for 48V output, 9V to 20V for 24V output
- High light-load efficiency in pulse skipping DEM operation
- Programmable soft-start
- Optional DEM/PWM operation
- Optional CC/HICCUP OCP protection
- Supports pre-bias output with soft-start
- PGOOD indicator
- OVP, OTP, and UVP protection
- External bias to improve efficiency
- Optional input/output average OCP

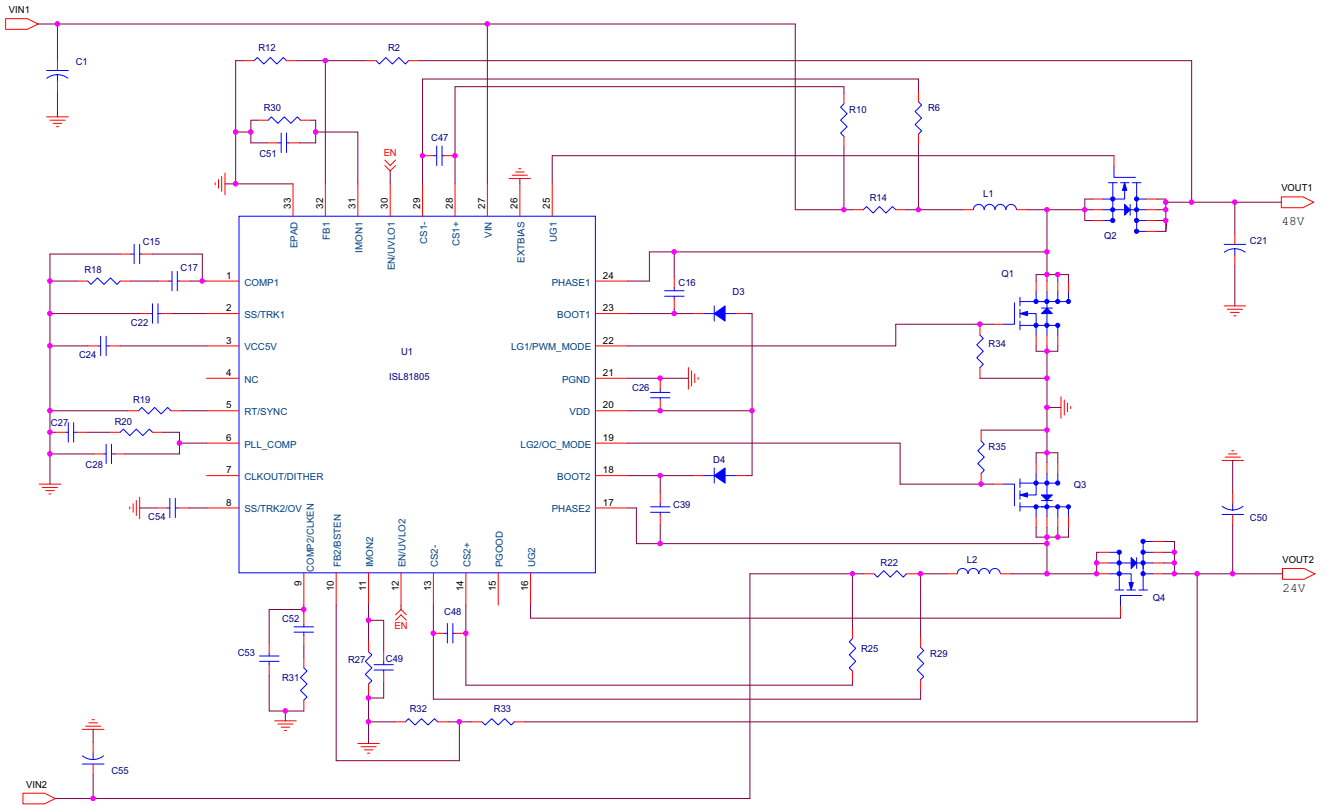

Figure 1. ISL81805EVAL2Z Block Diagram

## Contents

<b>1. Functional Description</b>	<b>4</b>
1.1 Recommended Testing Equipment	4
1.2 Operating Range	4
1.3 Quick Test Guide	4
<b>2. Board Design</b>	<b>6</b>
2.1 PCB Layout Guidelines	7
2.2 Schematic Drawing	8
2.3 Bill of Materials	9
2.4 Board Layout	11
2.5 Design Procedure	14
2.5.1 Design Requirements	14
2.5.2 Frequency Setting	14
2.5.3 Output Voltage Setting	15
2.5.4 UVLO Setting	15
2.5.5 Soft-Start Capacitor	15
2.5.6 MOSFET Considerations	16
2.5.7 Inductor Selection	16
2.5.8 Output Capacitor Selection	17
2.5.9 Input Capacitor Selection	17
2.5.10 First Level Peak Current Limit and Sense Resistor Selection	17
2.5.11 Second Level Hiccup Peak Current Protection	18
2.5.12 Input Average Overcurrent Protection and $R_{IM}$ Selection	18
2.5.13 PWM Mode Selection	18
2.5.14 Overcurrent Protection Mode Selection	18
2.5.15 Phase Lock Loop (PLL)	18
2.5.16 Feedback Loop Compensation	19
<b>3. Typical Performance Curves</b>	<b>22</b>
<b>4. Ordering Information</b>	<b>25</b>
<b>5. Revision History</b>	<b>25</b>

# 1. Functional Description

The ISL81805EVAL2Z is the same test board used by Renesas application engineers and IC designers to evaluate the performance of the ISL81805 TQFN IC. The board provides an easy and complete evaluation of all the IC and board functions.

As shown in [Figure 3](#), the 9V to 36V  $V_{IN1}$  is supplied to J1 (+) and J2 (-). The regulated 48V output  $V_{O1}$  is on J4 (+) and J5 (-). Because of the high-power efficiency, Channel 1 can run at 3A continuously without airflow at ambient room temperature conditions. The 9V to 20V  $V_{IN2}$  is supplied to J20 (+) and J21 (-). The regulated 24V output  $V_{OUT2}$  is on J17 (+) and J16 (-). Because of the high-power efficiency, Channel 2 can run at 5A continuously without airflow at ambient room temperature conditions.

Test points TP1 through TP26 provide easy access to the IC pin and external signal injection terminals.

As shown in [Table 2](#), connector J6 provides a selection of either Forced PWM mode (shorting Pin 1 and Pin 2) or DEM mode (shorting Pin 2 and Pin 3). Connector J7 provides a selection of either constant current limit (shorting Pin 1 and Pin 2) or HICCUP OCP (shorting Pin 2 and Pin 3). Connector J3 and J19 provide an option to disable each output respectively by shorting their Pin 1 and Pin 2.

## 1.1 Recommended Testing Equipment

The following materials are recommended for testing:

- 0V to 40V power supply with at least 25A source current capability
- Electronic loads capable of sinking current up to 7A
- Digital Multimeters (DMMs)
- 100MHz quad-trace oscilloscope

## 1.2 Operating Range

The input voltage range is from 9V to 36V for the 48V output, while the input voltage range is from 9V to 20V for the 24V output. If the output voltage is set to a lower value, the minimum  $V_{IN}$  can be reset to a lower value by changing the ratio of  $R_1$  and  $R_5$ . The minimum EN threshold that  $V_{IN}$  can be set to is 4.5V.

The rated load currents for each output are 3A and 5A with the input OCP point set at a minimum 13.8A for Channel 1 and 12.6A for Channel 2 at ambient room temperature conditions. The operating temperature range of this board is -40°C to +85°C.

**Note:** Airflow is needed for higher ambient temperature conditions.

## 1.3 Quick Test Guide

1. Jumper J6 provides the option to select PWM or DEM. Jumper J7 provides the option to select a constant current limit or HICCUP. See [Table 2](#) for the operating options. Ensure that the circuit is correctly connected to the supply and electronic loads before applying any power. See [Figure 3](#) for the proper setup.
2. Turn on the power supply.
3. Adjust the input voltage ( $V_{IN}$ ) within the specified range and observe the output voltage. The output voltage variation should be within 3%.
4. Adjust the load current within the specified range and observe the output voltage. The output voltage variation should be within 3%.
5. Use an oscilloscope to observe output voltage ripple and phase node ringing. For accurate measurement, see [Figure 2](#) for the proper test setup.

**Note:** Renesas recommends adding a minimum 0.1A load current if configured as DEM.

**Table 2. Operating Options**

Jumper	Position	Function
3	EN1-GND	Disable 48V output
	EN1 Floating	Enable 48V output
19	EN2-GND	Disable 24V output
	EN2 Floating	Enable 24V output
6	Pin 1-2	PWM
	Pin 2-3	DEM
7	Pin 1-2	Constant current limit
	Pin 2-3	HICCUP

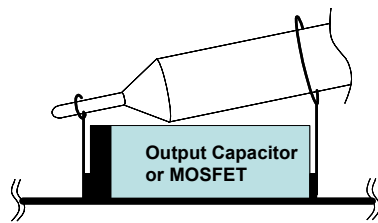

**Figure 2. Proper Probe Setup to Measure Output Ripple and Phase Node Ringing**

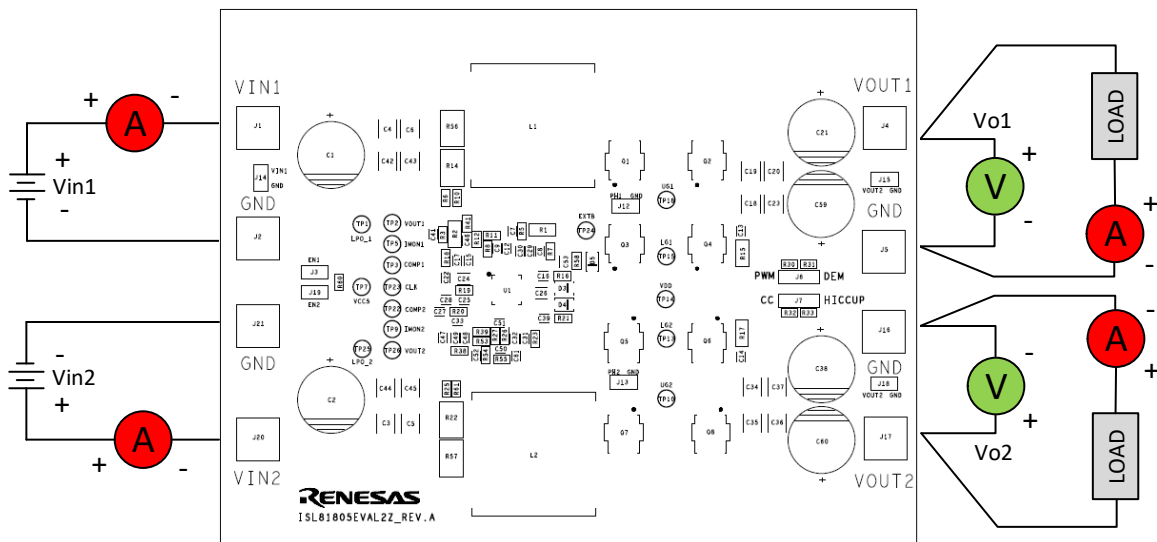

**Figure 3. Proper Test Setup**

## 2. Board Design

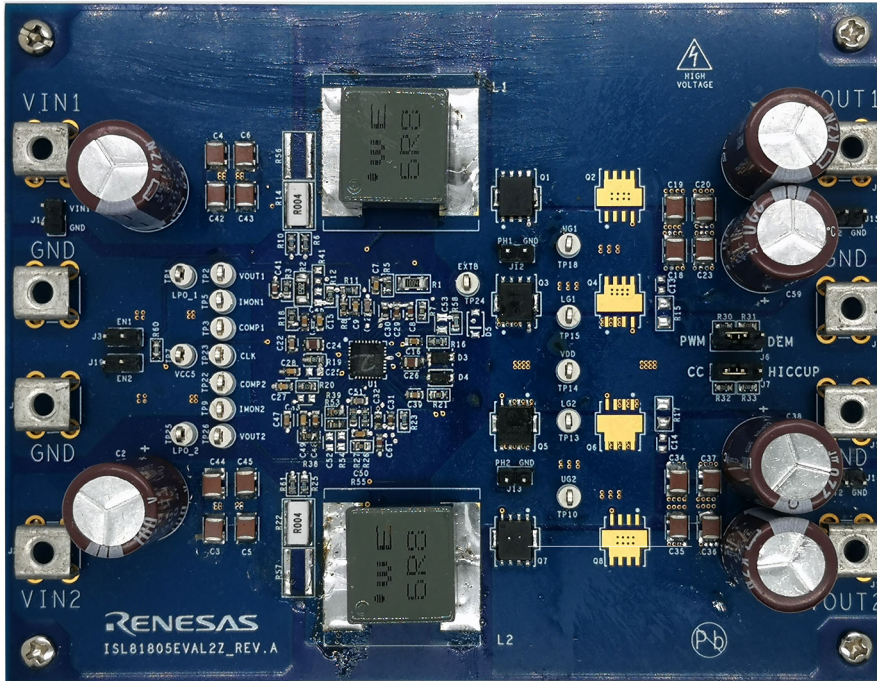

Figure 4. ISL81805EVAL2Z Evaluation Board, Top View

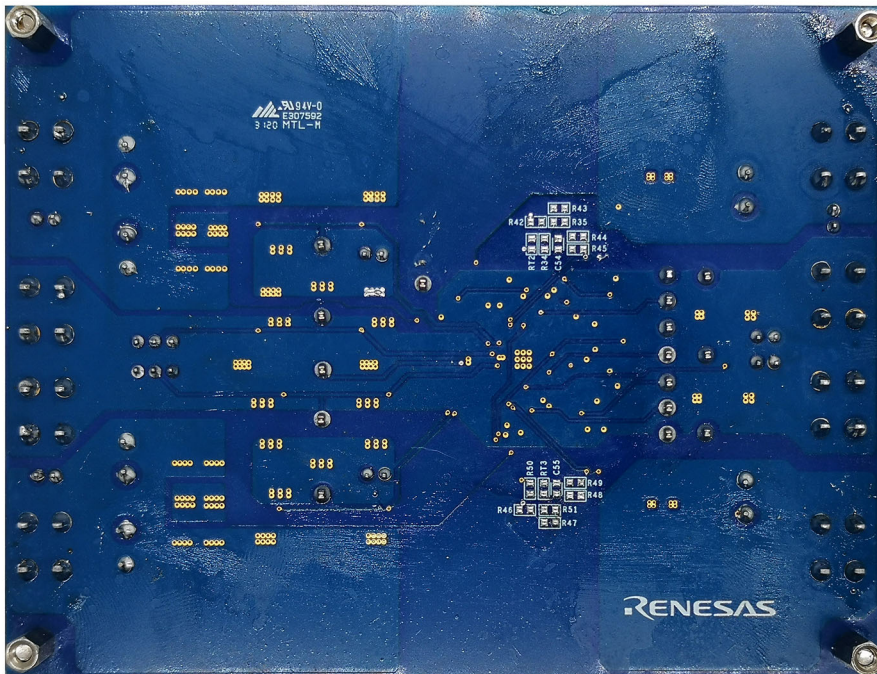

Figure 5. ISL81805EVAL2Z Evaluation Board, Bottom View

## 2.1 PCB Layout Guidelines

Careful attention to Printed Circuit Board (PCB) layout requirements is necessary for the successful implementation of an ISL81805 based DC/DC converter. The ISL81805 switches at a high frequency; therefore, the switching times are short. At these switching frequencies, even the shortest trace has significant impedance and the peak gate drive current rises significantly in an extremely short time. The transition speed of the current from one device to another causes voltage spikes across the interconnecting impedances and parasitic circuit elements. These voltage spikes can degrade efficiency, generate EMI, and increase device voltage stress and ringing. Careful component selection and proper PCB layout minimize the magnitude of these voltage spikes.

Three sets of components are critical when using the ISL81805 DC/DC converter:

- Controller
- Switching power components
- Small-signal components

The switching power components are the most critical to the layout because they switch a large amount of energy, which tends to generate a large amount of noise. The critical small-signal components are those connected to sensitive nodes or those supplying critical bias currents. A multilayer PCB is recommended.

Complete the following steps to optimize the PCB layout.

- Place the input capacitors, inductor, boost FETs, and output capacitor first. Isolate these power components on dedicated areas of the board with their ground terminals adjacent to one another. Place the input and output high frequency decoupling ceramic capacitors close to the MOSFETs.
- If signal components and the IC are placed in a separate area to the power train, use full ground planes in the internal layers with shared SGND and PGND to simplify the layout design. Otherwise, use separate ground planes for the power ground and the small-signal ground. Connect the SGND and PGND close to the IC. DO NOT connect them anywhere else.
- Keep the loop formed by the output capacitor, the boost top FET, and the boost bottom FET as small as possible.
- Keep the current paths from the input capacitor to the power inductor, the boost FETs, and the output capacitor as short as possible with maximum allowable trace widths.
- Place the PWM controller IC close to the lower FETs. The low-side FETs gate drive connections should be short and wide. Place the IC over a quiet ground area. Avoid switching ground loop currents in this area.
- Place the VDD bypass capacitor close to the VDD pin of the IC and connect its ground end to the PGND pin. Connect the PGND pin to the ground plane using a via. DO NOT directly connect the PGND pin to the SGND EPAD.
- Place the gate drive components (BOOT diodes and BOOT capacitors) together near the controller IC.
- Use copper filled polygons or wide short traces to connect the junction of the upper FET, lower FET, and output inductor. Also, keep the PHASE nodes connection to the IC short. DO NOT oversize the copper islands for the PHASE nodes. Because the phase nodes are subjected to high dv/dt voltages, the stray capacitor formed between these islands and the surrounding circuitry tends to couple switching noise.
- Route all high-speed switching nodes away from the control circuitry.
- Create a separate small analog ground plane near the IC. Connect the SGND pin to this plane. Connect all small signal grounding paths including feedback resistors, current monitoring resistors and capacitors, soft-starting capacitors, loop compensation capacitors and resistors, and EN pull-down resistors to this SGND plane.
- Use a pair of traces with minimum loop for the input or output current sensing connection.
- Ensure the feedback connection to the output capacitor is short and direct.

## 2.2 Schematic Drawing

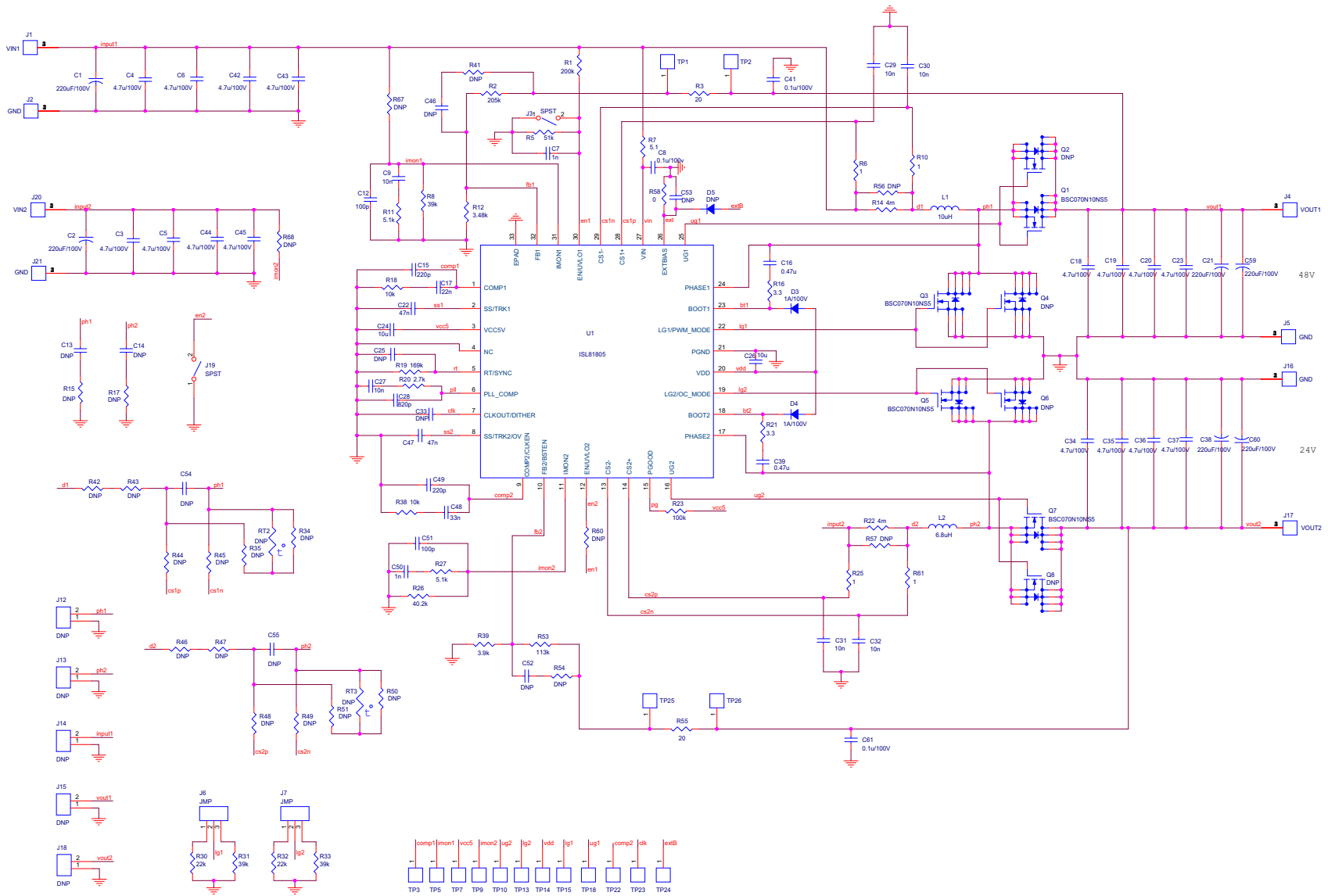

Figure 6. Schematic



## 2.3 Bill of Materials

Qty	Reference Designator	Description	Manufacturer	Manufacturer Part
1		PWB-PCB, ISL81805EVAL2Z, REVA, ROHS	Multilayer PCB Technology	ISL81805EVAL1ZREVAPCB
6	C1, C2, C21, C38, C59, C60	CAP, RADIAL, 12.5x26.5, 220 $\mu$ F, 100V, 20%, ALUM.ELEC., 5mm, ROHS	United Chemi-Con	EKZN101ELL221MK25S
16	C3, C4, C5, C6, C18, C19, C20, C23, C34, C35, C36, C37, C42, C43, C44, C45	CAP-AEC-Q200, SMD, 1210, 4.7 $\mu$ F, 100V, 10%, X7S, ROHS	TDK	CGA6M3X7S2A475K200AB
2	C7, C50	CAP, SMD, 0603, 1000pF, 50V, 10%, X7R, ROHS	TDK	C1608X7R1H102K080AE
3	C8, C41, C61	CAP, SMD, 0603, 0.1 $\mu$ F, 100V, 10%, X7R, ROHS	Vishay	GRJ188R72A104KE11D
7	C9, C27, C29, C30, C31, C32, C49	CAP, SMD, 0603, 0.01 $\mu$ F, 100V, 10%, X7R, ROHS	Kemet	C0603C103J1RACTU
2	C12, C51	CAP, SMD, 0603, 100pF, 50V, X7R, 10%, ROHS	Kemet	C0603C101K5RACTU
1	C15	CAP, SMD, 0603, 220pF, 50V, 10%, X7R, ROHS	Murata	GRM188R71H221KA01D
2	C16, C39	CAP, SMD, 0603, 0.47 $\mu$ F, 25V, 10%, X7R, ROHS	Murata	GRM188R71E474KA12D
1	C17	CAP, SMD, 0603, 0.022 $\mu$ F, 25V, X7R, ROHS	TDK	CGJ3E2X7R1E223K080AA
2	C22, C47	CAP, SMD, 0603, 0.047 $\mu$ F, 25V, X7R, ROHS	Murata	GRM188R71E473KA01D
2	C24, C26	CAP, SMD, 0805, 10 $\mu$ F, 16V, 10%, X7S, ROHS	Murata	GRM21BC71C106KE11L
1	C28	CAP, SMD, 0603, 820pF, 50V, 10%, X7R, ROHS	Kemet	C0603C821K5RACTU
1	C48	CAP, SMD, 0603, 0.033 $\mu$ F, 25V, X7R, ROHS	Murata	GRM188R71E333KA01D
0	C13, C14, C25, C33, C46, C52, C54, C55	CAP, SMD, 0603, DNP-PLACE HOLDER, ROHS		
0	C53	CAP, SMD, 0805, DNP-PLACE HOLDER, ROHS		
2	D3, D4	DIODE-RECTIFIER, SMD, 2P, SOD-123FL, 100V, 1A, ROHS	ON Semiconductor	MBR1H100SFT3G
0	D5	DIODE, DNP, SOD-123FL		
8	J1, J2, J4, J5, J16, J17, J20, J21	HDWARE, TERMINAL, M4 METRIC SCREW, TH, 4P, SNAP-FIT, ROHS	Keystone	7795
2	J3, J19	CONN-HEADER, 1x2, BRKAWY 1x36, 2.54mm, ROHS	BERG/FCI	69190-202HLF
2	J6, J7	CONN-HEADER, 1x3, BREAKAWY 1x36, 2.54mm, ROHS	BERG/FCI	68000-236HLF
0	J12, J13, J14, J15, J18	2.54mm Headers, DNP-PLACE HOLDER, ROHS		

Qty	Reference Designator	Description	Manufacturer	Manufacturer Part
1	L1	COIL-PWR INDUCTOR, SMD, 10 $\mu$ H, 20%, 11.5A, 6.5m $\Omega$ , ROHS	Würth	74439370100
1	L2	COIL-PWR INDUCTOR, SMD, 6.8 $\mu$ H, 20%, 15A, 4.1m $\Omega$ , ROHS	Würth	74439370068
1	U1	80V DUAL-BOOST PWM CONTROLLER, 32P, TQFN, 5x5, ROHS	Renesas Electronics America	ISL81805FRTZ
4	Q1, Q3, Q5, Q7	TRANSISTOR-MOS, N-CHANNEL, SMD, 8P, PPK SO-8, 100V, 80A, ROHS	Infineon	BSC070N10NS5ATMA1
0	Q2, Q4, Q6, Q8	DO NOT POPULATE OR PURCHASE		
1	R1	RES SMD 200k $\Omega$ 1% 1/4W 1206	Yageo	RC0603FR-07200KL
1	R2	RES SMD 48.7k $\Omega$ 1% 1/10W 0603	Yageo	RC0603FR-0748K7L
2	R3, R55	RES SMD 20 $\Omega$ 1% 1/10W 0603	Yageo	RC0603FR-0720RL
3	R5, R31, R33	RES SMD 51k $\Omega$ 1% 1/10W 0603	Yageo	RC0603FR-0751KL
4	R6, R10, R25, R61	RES SMD 1 $\Omega$ 1% 1/10W 0603	Panasonic	ERJ-3RQF1R0V
1	R7	RES SMD 5.1 $\Omega$ 1% 1/10W 0603	Yageo	RC0603FR-075R1L
1	R8	RES SMD 39k $\Omega$ 1% 1/10W 0603	Yageo	RC0603FR-0739KL
1	R26	RES SMD 40.2k $\Omega$ 1% 1/10W 0603	Yageo	RC0603FR-0740K2L
2	R11, R27	RES SMD 5.1k $\Omega$ 1% 1/10W 0603	Yageo	RC0603FR-075K1L
1	R12	RES SMD 3.48k $\Omega$ 1% 1/10W 0603	Yageo	RC0603FR-073K48L
2	R14, R22	RES SMD 0.004 $\Omega$ 3W 2512 WIDE	Susumu	KRL6432E-M-R004-F-T1
2	R16, R21	RES SMD 3.3 $\Omega$ 1% 1/10W 0603	Yageo	RC0603FR-073R3L
2	R18, R38	RES SMD 10k $\Omega$ 1% 1/10W 0603	Yageo	RC0603FR-0710KL
1	R19	RES SMD 169k $\Omega$ 1% 1/10W 0603	Venkel	CR0603-10W-1693FT
1	R20	RES SMD 2.7k $\Omega$ 1% 1/10W 0603	Yageo	RC0603FR-072K7L
1	R23	RES SMD 100k $\Omega$ 1% 1/10W 0603	Yageo	RC0603FR-07100KL
2	R30, R32	RES SMD 15k $\Omega$ 1% 1/10W 0603	Yageo	RC0603FR-0715KL
1	R39	RES SMD 3.9k $\Omega$ 1% 1/10W 0603	Yageo	RC0603FR-073K9L
1	R53	RES SMD 113k $\Omega$ 1% 1/10W 0603	Yageo	RC0603FR-07113KL
1	R58	RES SMD 0 $\Omega$ 1% 1/10W 0603	Yageo	RC0603FR-070RL
0	RT2, RT3, R34, R35, R41, R42, R43, R44, R45, R46, R47, R48, R49, R50, R51, R54, R60, R67, R68	RES, SMD, 0603, DNP-PLACE HOLDER, ROHS		
0	R15, R17	RES, SMD, 1206, DNP-PLACE HOLDER, ROHS		
0	R56, R57	RES, SMD, 2512, DNP-PLACE HOLDER, ROHS		
16	TP1, TP2, TP3, TP5, TP7, TP9, TP10, TP13, TP14, TP15, TP18, TP22, TP23, TP24, TP25, TP26	CONN-COMPACT TEST PT, VERTICAL, WHT, ROHS	Keystone	5007

Qty	Reference Designator	Description	Manufacturer	Manufacturer Part
2	J6, J7	CONN-JUMPER, SHORTING, 2PIN, BLACK, GOLD, ROHS	Sullins	SPC02SYAN
4	Four corners	SCREW, 4-40x1/4in, PHILLIPS, PANHEAD, STAINLESS, ROHS	Keystone	2204
4	Four corners	STANDOFF, 4-40x3/4in, F/F, HEX, ALUMINUM, 0.25 OD, ROHS	Keystone	7795

## 2.4 Board Layout

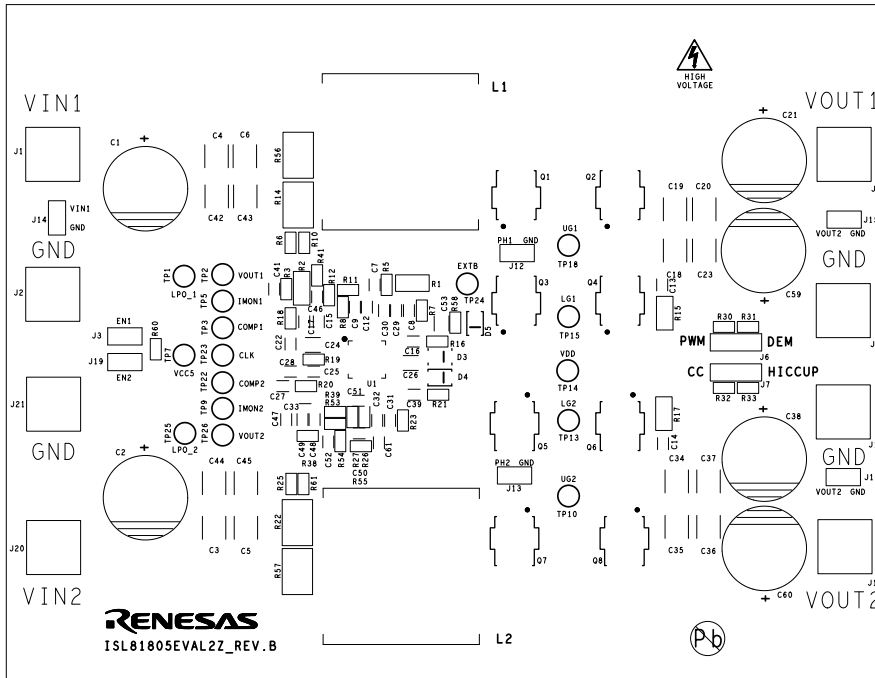

Figure 7. Silkscreen Top

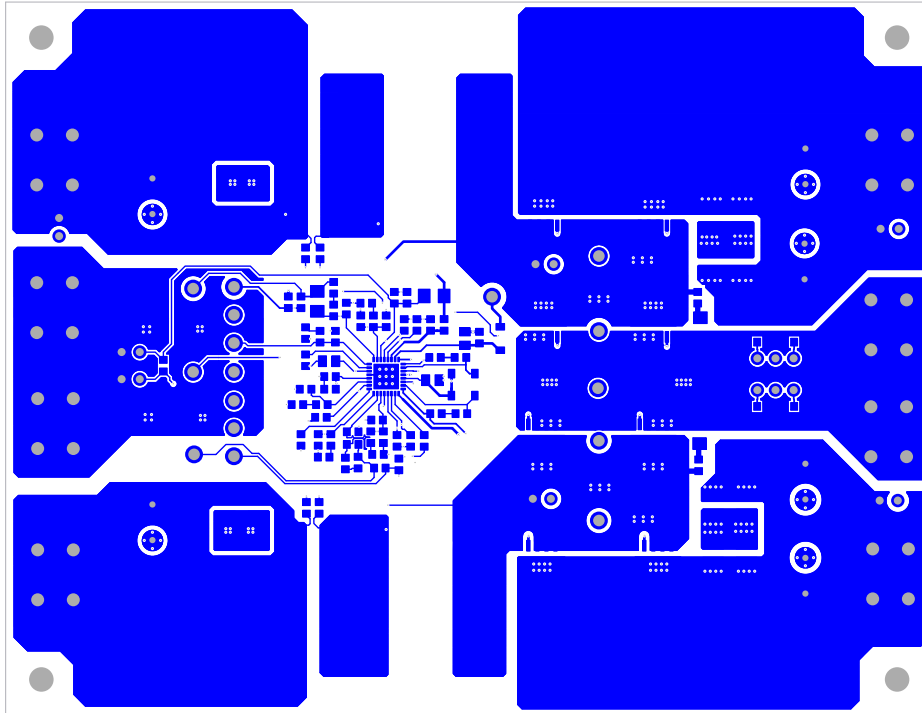

Figure 8. Top Layer

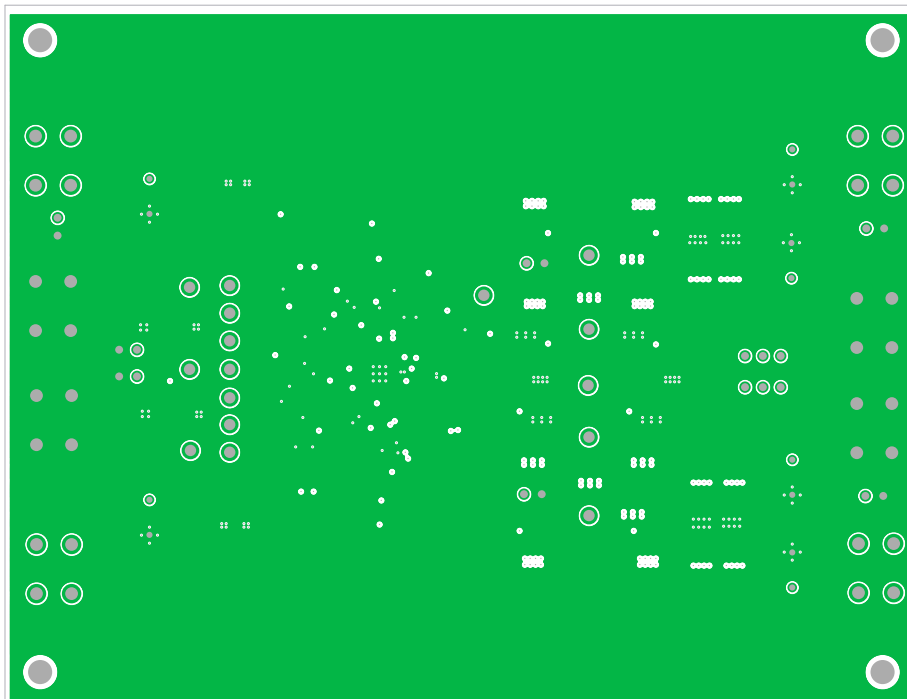

Figure 9. Second Layer (Solid Ground)

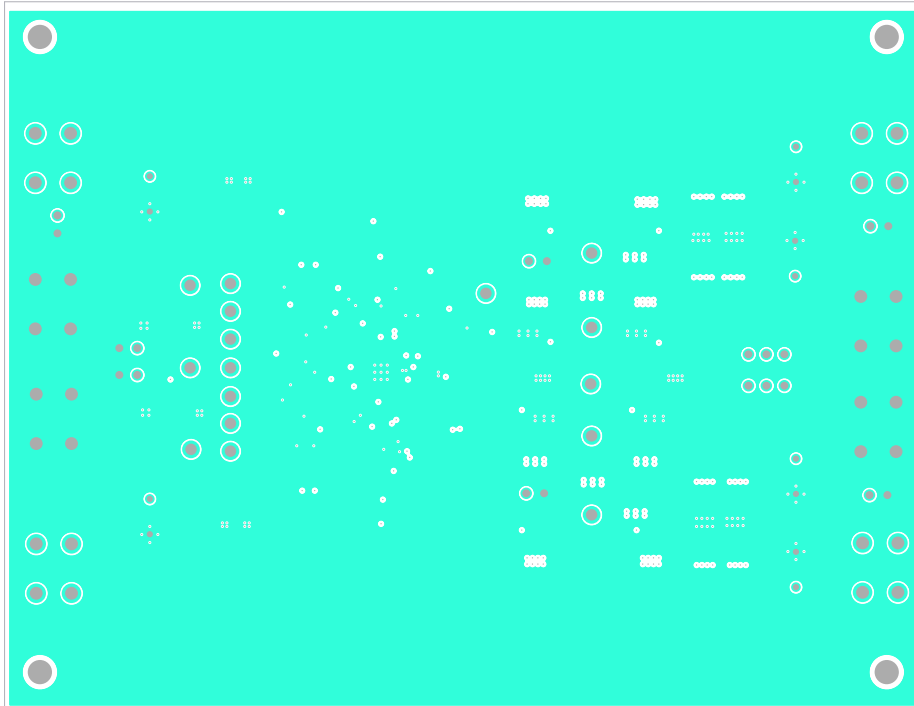

Figure 10. Third Layer

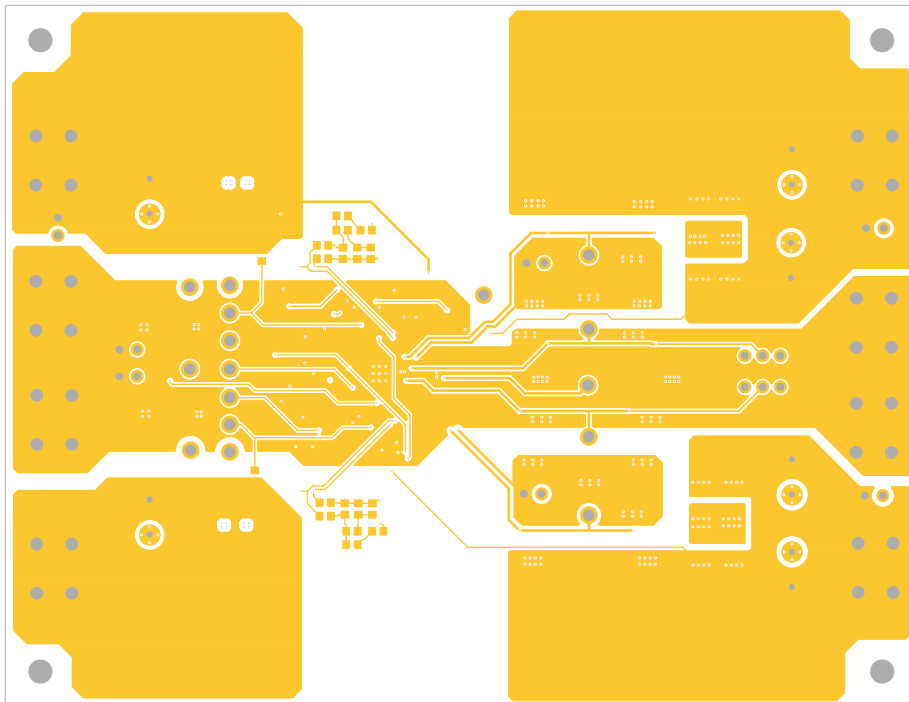

Figure 11. Bottom Layer

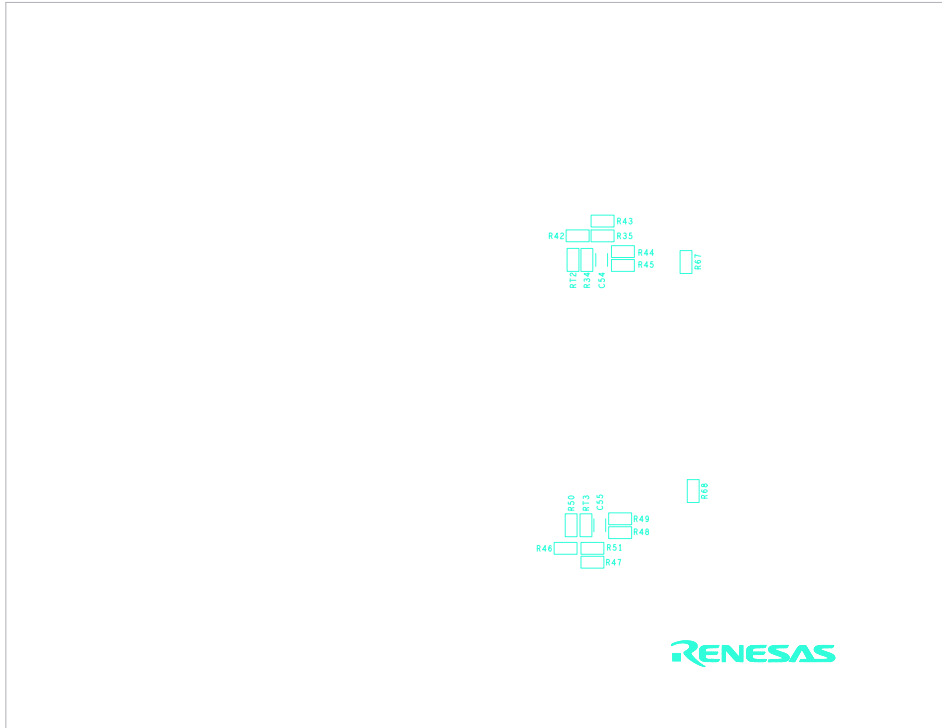

Figure 12. Silkscreen Bottom

## 2.5 Design Procedure

### 2.5.1 Design Requirements

Parameter	Rating
Input Voltage	9V to 36V for 48V output 9V to 20V for 24V output
Switching Frequency	200kHz
Output Voltage 1	48V
Output Current 1	3A
Output Voltage 2	24V
Output Current 2	5A
OCP Set Point (input average)	13.8A for 48V output, 12.6A for 24V output
Output Mode	Dual output
PWM Mode	Forced PWM
OCP Mode	Constant current

### 2.5.2 Frequency Setting

The default switching frequency of the PWM controller is determined by the resistor  $R_T$  (R19). It adjusts the default switching frequency from 100kHz to 1MHz. The  $R_T$  value for  $f_{SW} = 200\text{kHz}$  is calculated using [Equation 1](#).

$$(EQ. 1) \quad R_T = \left( \frac{34.7}{f_{SW}} - 4.78 \right) = \frac{34.7}{0.2} - 4.78 = 168.72\text{k}\Omega$$

where  $f_{SW}$  is the switching frequency in MHz. Select a standard value resistor  $R_T = 169\text{k}\Omega$ .

### 2.5.3 Output Voltage Setting

The output voltage can be set from 0.8V up to a level determined by the feedback voltage divider. A resistive divider from the output to ground sets the output voltage. Connect the center point of the divider to the FB1 pin. With  $V_{OUT1} = 48V$ ,  $R_{FBO1}$  (R2) = 205k, the  $R_{FBO2}$  (R12) value is calculated using Equation 2.

$$(EQ. 2) \quad R_{FBO2(12V)} = \frac{0.8V \times R_{FBO1}}{V_{OUT1} - 0.8V} = \frac{0.8V \times 205k\Omega}{48V - 0.8V} = 3.47k\Omega$$

Select a standard value resistor  $R_{FBO2} = 3.48k\Omega$ .

With  $V_{OUT2} = 24V$ ,  $R_{FBO1}$  (R53) = 113k, the  $R_{FBO2}$  (R39) value is calculated using Equation 3.

$$(EQ. 3) \quad R_{FBO2(5V)} = \frac{0.8V \times R_{FBO1}}{V_{OUT2} - 0.8V} = \frac{0.8V \times 113k\Omega}{24V - 0.8V} = 3.89k\Omega$$

Select a standard value resistor  $R_{FBO2} = 3.9k\Omega$ .  $R_{FBO1}$  is the top resistor of the feedback divider network and  $R_{FBO2}$  is the bottom resistor connected from FB1 to ground.

### 2.5.4 UVLO Setting

The ISL81805 has input UVLO protection. When the voltage on the EN/UVLO pin reaches 1.8V, the PWM modulator is enabled. Accurate UVLO feature can be implemented by feeding the  $V_{IN}$  into the EN/UVLO pin using a voltage divider,  $R_{UV1}$  (R1) and  $R_{UV2}$  (R5). The  $V_{IN}$  UVP rising threshold is calculated using Equation 4.

$$(EQ. 4) \quad V_{UVRISE} = \frac{V_{UVLO\_THR}(R_{UV1} + R_{UV2}) - I_{LEAK}R_{UV1}R_{UV2}}{R_{UV2}} = \frac{1.8V(200k\Omega + 51k\Omega) - 1.4\mu A(200k\Omega)(51k\Omega)}{51k\Omega} = 8.58V$$

The  $V_{IN}$  UVP falling threshold is calculated using Equation 5.

$$(EQ. 5) \quad V_{UVFALL} = \frac{V_{UVLO\_THR}(R_{UV1} + R_{UV2}) - I_{UVLO\_HYST} R_{UV1}R_{UV2}}{R_{UV2}} \\ = \frac{1.8V(200k\Omega + 51k\Omega) - 3.4\mu A(200k\Omega)(51k\Omega)}{51k\Omega} = 8.18V$$

where  $V_{UVLO\_THR}$  is the 1.8V UVLO rising threshold and  $I_{UVLO\_HYST}$  is the 3.4 $\mu$ A UVLO hysteresis current.

### 2.5.5 Soft-Start Capacitor

The soft-start time for dual output is set by the value of the soft-start capacitor  $C_{SS1}$  (C22) connected from SS/TRK1 to GND and  $C_{SS2}$  (C47) connected from SS/TRK2 to GND separately. The soft-start time with  $C_{SS1} = C_{SS2} = 47nF$  is calculated using Equation 6.

$$(EQ. 6) \quad t_{SS} = 0.8V \left( \frac{C_{SS}}{2\mu A} \right) = 0.8V \times \left( \frac{47nF}{2\mu A} \right) = 18.8ms$$

When the soft-start time set by external  $C_{SS}$  or tracking is less than 1.7ms, an internal soft-start circuit of 1.7ms takes over the soft-start.

## 2.5.6 MOSFET Considerations

The MOSFETs are selected based on  $r_{DS(ON)}$ , gate supply requirements, and thermal management considerations.

The power loss of the upper and lower MOSFETs for the 48V output are calculated using [Equation 7](#) and [Equation 8](#). The equations assume linear voltage current transitions and ignore the power loss caused by the reverse recovery of the body diode of the lower MOSFET.

$$\begin{aligned}
 P_{\text{LOWERMAX}} &= \left[ \frac{(I_{\text{OUT}})^2 (V_{\text{OUT}})^2}{(V_{\text{INMIN}})^2} \right] \frac{(V_{\text{OUT}} - V_{\text{INMIN}})(r_{\text{DS(ON)}})}{V_{\text{OUT}}} + \frac{(I_{\text{OUT}})(V_{\text{OUT}})^2 (t_{\text{SW}})(f_{\text{SW}})}{2(V_{\text{INMIN}})} \\
 \text{(EQ. 7)} \quad &= \left[ \frac{\left(\frac{3\text{A}}{2}\right)^2 (48\text{V})^2}{(12\text{V})^2} \right] \frac{(48\text{V} - 12\text{V})(6\text{m}\Omega)}{48\text{V}} + \frac{\left(\frac{3\text{A}}{2}\right)(48\text{V})^2 \left( \frac{6\text{nC}}{\left(\frac{8\text{V} - 4.9\text{V}}{1\Omega}\right)} + \frac{6\text{nC}}{\left(\frac{4.9\text{V}}{1\Omega}\right)} \right) (200\text{kHz})}{2(12\text{V})} = 0.162\text{W} + 0.09\text{W} = 0.252\text{W}
 \end{aligned}$$

$$\text{(EQ. 8)} \quad P_{\text{UPPERMAX}} = \frac{(I_{\text{OUT}})^2 (r_{\text{DS(ON)}})(V_{\text{OUT}})}{V_{\text{INMIN}}} = \frac{\left(\frac{3\text{A}}{2}\right)^2 (6\text{m}\Omega)(48\text{V})}{12\text{V}} = 0.054\text{W}$$

Ensure that all MOSFETs are within their maximum junction temperature with enough margin at high ambient temperature by calculating the temperature rise according to package thermal resistance specifications.

## 2.5.7 Inductor Selection

The inductor value determines the ripple current of the converter. To limit the inductor core loss, the inductor ripple current is usually 40-80% of the rated output current. Assume the ripple current ratio is 80% of the inductor average current at the maximum input voltage and the full output load condition. The inductor value for the 48V output is calculated using [Equation 9](#).

$$\text{(EQ. 9)} \quad L_{\text{INMIN}} = \frac{(V_{\text{OUT}} - V_{\text{INMIN}})(V_{\text{INMIN}})}{(f_{\text{SW}})(0.8 \times I_{\text{INMAX}})(V_{\text{OUT}})} = \frac{(48\text{V} - 12\text{V})(12\text{V})}{(200\text{kHz})\left(0.8 \times \frac{48\text{V} \times 3\text{A}}{12\text{V} \times 2}\right)(48\text{V})} = 9.375\mu\text{H}$$

The recommended inductor value is 10 $\mu\text{H}$ . Then the ripple current and peak current are calculated using [Equation 10](#), [Equation 11](#), and [Equation 12](#).

$$\text{(EQ. 10)} \quad \Delta I_{\text{LMAX}} = \frac{(V_{\text{OUT}} - V_{\text{IN}})(V_{\text{IN}})}{(f_{\text{SW}})(L)(V_{\text{OUT}})} = \frac{(48\text{V} - 12\text{V})(12\text{V})}{(200\text{kHz})(10\mu\text{H})(48\text{V})} = 4.5\text{A}$$

$$\text{(EQ. 11)} \quad I_{\text{LRMSMAX}} = \sqrt{(I_{\text{INMAX}})^2 + \frac{(\Delta I_{\text{LMAX}})^2}{12}} = \sqrt{\left(\frac{48\text{V} \times 3\text{A}}{12\text{V} \times 2}\right)^2 + \frac{(4.5\text{A})^2}{12}} = 6.14\text{A}$$

$$\text{(EQ. 12)} \quad I_{\text{LPEAKMAX}} = I_{\text{INOC1}} + \frac{\Delta I_{\text{LMAX}}}{2} = 11\text{A} + \frac{4.5\text{A}}{2} = 13.25\text{A}$$

The saturation current of the inductor should be larger than 13.25A. The heat rating current of the inductor should be larger than 6.14A.

With inductor 74439370100 from Würth Electronics, the maximum DC power dissipation in the inductor is approximately calculated using [Equation 13](#).

$$\text{(EQ. 13)} \quad P_{\text{LMAX}} = (I_{\text{LRMS}})^2 (\text{DCR}) = (6.14\text{A})^2 \times (6.4\text{m}\Omega) = 0.241\text{W}$$



## 2.5.8 Output Capacitor Selection

The maximum capacitor value required to provide the full, rising step, transient load current during the response time of the inductor for the 48V output is shown in [Equation 14](#).

$$(EQ. 14) \quad C_{OUTMIN} = \frac{L(V_{OUT})(I_{TRAN})^2}{2(V_{INMIN})^2(\Delta V_{OUT})} = \frac{10\mu H \times (48V) \times \left(\frac{3A}{2} - 0A\right)^2}{2(12V)^2\left(48V \times \frac{1}{100}\right)} = 7.8\mu F$$

where  $C_{OUTMIN}$  is the minimum output capacitor(s) required,  $I_{TRAN}$  is the transient load current step, and  $\Delta V_{OUT}$  is the drop in output voltage allowed during the load transient. Choose a capacitor no less than 7.8 $\mu$ F for the 48V output. 220 $\mu$ F electrolytic capacitor and 18.8 $\mu$ F MLCC in total are used for the 48V output.

The output voltage ripple is because of the discontinuous ripple current to the output capacitor and the ESR of the output capacitors as defined by [Equation 15](#).

$$(EQ. 15) \quad V_{RIPPLE} = \left( \frac{(I_{OUT})(V_{OUT})}{V_{INMIN}} + \frac{\Delta I_L}{2} \right) \times ESR = \left( \frac{\left(\frac{3A}{2}\right)(48V)}{12V} + \frac{4.5A}{2} \right) \times 5m\Omega = 41.25mV$$

## 2.5.9 Input Capacitor Selection

The important parameters for the input capacitors are the voltage rating and the RMS current rating. The capacitor voltage rating should be at least 1.25 times greater than the maximum input voltage and 1.5 times is a conservative guideline.

In Boost mode, the input current is continuous. The RMS current supplied by the input capacitance is noticeably small.

Renesas recommends using a mix of input bypass capacitors to control the voltage ripple across the MOSFETs. Use ceramic capacitors for the high frequency decoupling and bulk capacitors to supply the RMS current. Two 220 $\mu$ F electrolytic capacitors with 2.2A rating current and eight 4.7 $\mu$ F ceramic capacitors are used to share the input RMS current on this board.

## 2.5.10 First Level Peak Current Limit and Sense Resistor Selection

The inductor peak current for 48V output is sensed by the shunt resistor  $R_S$  (R14). When the voltage drop on  $R_S$  reaches the set point  $V_{OCSET-CS}$  typical 85mV, it triggers the pulse-by-pulse peak current limit. With the current limit set point  $I_{OCPP1} = 1.7 \times I_{INMAX} = 20.4A$  for each phase, the value of the sense resistor is calculated using [Equation 16](#).

$$(EQ. 16) \quad R_S = \frac{V_{OCSET-CS}}{I_{OCPP1}} = \frac{82mV}{20.4A} = 4.02m\Omega$$

Select a standard value resistor  $R_S = 4m\Omega$ . Then the actual peak current limit is calculated using [Equation 17](#).

$$(EQ. 17) \quad I_{OCPP1} = \frac{V_{OCSET-CS}}{R_S} = \frac{82mV}{4m\Omega} = 20.5A$$

The maximum power dissipation in  $R_S$  is calculated using [Equation 18](#).

$$(EQ. 18) \quad P_{RSMAX} = (I_{IN})^2 R_S = (6.14A)^2 (4m\Omega) = 0.15W$$

Therefore, a sense resistor with 1W power rating is sufficient for this application.

### 2.5.11 Second Level Hiccup Peak Current Protection

In the condition,  $V_{IN}$  is so close to  $V_{OUT}$  that the inductor current runs away with the minimum on PWM duty. The ISL81805 integrates a second level hiccup type of peak current protection. The second level peak current protection set point  $I_{OCPP2}$  is calculated using [Equation 19](#).

$$(EQ. 19) \quad I_{OCPP2} = \frac{V_{OCSET-CS-HIC}}{R_S} = \frac{98mV}{4m\Omega} = 24.5A$$

### 2.5.12 Input Average Overcurrent Protection and $R_{IM}$ Selection

The ISL81805 provides either constant current or hiccup type of overcurrent protection for input average current. The OCP mode is set by a resistor connected between the LG2/OC\_MODE pin and ground. With input constant current/hiccup set point  $I_{INOC} = 13.8A$  for 48V output, the current monitoring resistor  $R_{IM}$  (R8) is calculated using [Equation 20](#).

$$(EQ. 20) \quad R_{IM} = \frac{1.2}{I_{OUTOC} \times R_S \times G_{m_{CS}} + I_{CSOFFSET}} = \frac{1.2V}{13.8A \times 4m\Omega \times 195\mu S + 20\mu A} = 39.01k\Omega$$

Select a standard value resistor  $R_{IM} = 39k\Omega$ .

The board can also be configured to be output average overcurrent protection by injecting into the IMON pin an additional signal that changes with  $V_{IN}$ . This can be implemented by the resistors R67 and R68, which are between the  $V_{IN}$  terminal and the IMON1/IMON2 pins.

### 2.5.13 PWM Mode Selection

You can set the ISL81805 to either forced PWM mode or DE mode. The mode is set by a resistor  $R_{PWMMODE}$  (R30 or R31) connected between the LG1/PWM\_MODE pin and GND. The critical resistor value for  $R_{PWMMODE}$  is calculated using [Equation 21](#).

$$(EQ. 21) \quad R_{PWMMODE} = \frac{0.3V}{10\mu A} = 30k\Omega$$

A resistor less than 30k $\Omega$  sets the converter to forced PWM mode, while a resistor higher than 30k $\Omega$  sets the converter to DE mode. Considering the tolerance in all temperature ranges, Renesas recommends using 22k $\Omega$  to set to Forced PWM mode and 39k $\Omega$  to set to DE mode.

### 2.5.14 Overcurrent Protection Mode Selection

The ISL81805 is set to either a constant current or hiccup type of overcurrent protection for input average current by selecting a different value of the resistor  $R_{OCMODE}$  (R32 or R33) connected between LG2/OC\_MODE and GND. The critical resistor value for  $R_{OCMODE}$  is calculated using [Equation 22](#).

$$(EQ. 22) \quad R_{OCMODE} = \frac{0.3V}{10\mu A} = 30k\Omega$$

A resistor less than 30k $\Omega$  sets the converter to Constant Current mode, while a resistor higher than 30k $\Omega$  sets the converter to Hiccup mode. Considering the tolerance in all temperature ranges, Renesas recommends using 22k $\Omega$  to set to constant current and 39k $\Omega$  to set to hiccup mode.

### 2.5.15 Phase Lock Loop (PLL)

The PLL of the ISL81805 ensures the wide range of accurate clock frequency and phase setting. It also makes the internal clock easily synchronized to an external clock with the frequency either lower or higher than the internal setting. The external compensation network of  $R_{PLL}$  (R20),  $C_{PLL1}$  (C27), and  $C_{PLL2}$  (C28) is needed to connect to the PLL\_COMP pin to ensure PLL stable operation. Renesas recommends choosing 2.7k $\Omega$  for  $R_{PLL}$ , 10nF for  $C_{PLL1}$ , and 820pF for  $C_{PLL2}$ .

## 2.5.16 Feedback Loop Compensation

To adapt the different applications, the controller is designed with an external compensation network. Figure 13 shows the peak current mode boost converter circuit.

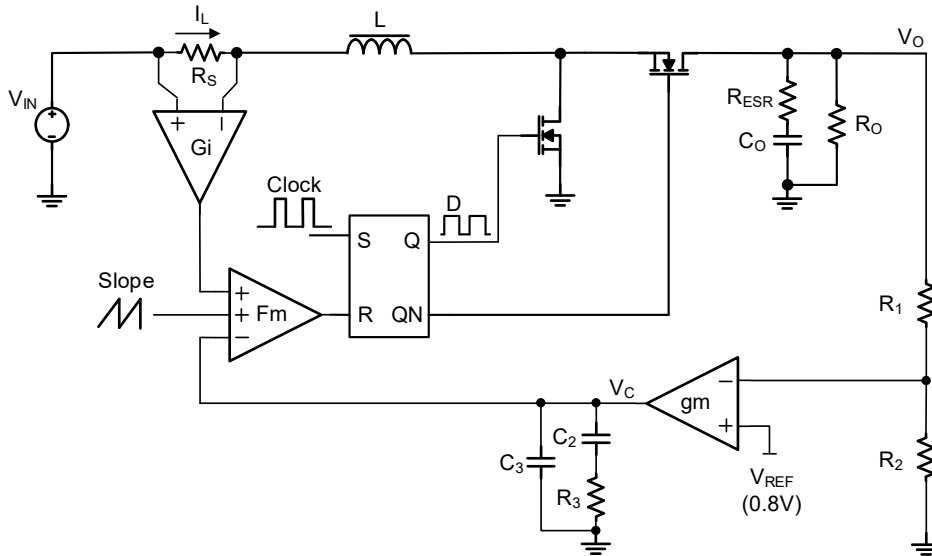

Figure 13. Peak Current Mode Boost Converter Circuit

In the current loop, the control to output simplified transfer function is shown in Equation 23.

$$(EQ. 23) \quad \frac{\hat{V}_O}{\hat{V}_C} = \frac{R_O \times (1-D)}{R_I \times K_d} \times \frac{\left(1 - \frac{s}{\omega_{RHPZ}}\right) \left(1 + \frac{s}{\omega_{z(esr)}}\right)}{\left(1 + \frac{s}{\omega_{po}}\right) \left(1 + \frac{s}{\omega_{pi}}\right)}$$

where:

$$(EQ. 24) \quad K_d = 2 + \frac{R_O \cdot (1-D)^2}{R_I} \cdot \left(\frac{1}{K_m} + \frac{K}{1-D}\right)$$

$$(EQ. 25) \quad K_m = \frac{1}{(D-0.5)R_I \times \frac{T_s}{L} + \frac{V_{SL}}{V_O}}$$

$$(EQ. 26) \quad K = 0.5R_I \times \frac{T_s}{L} \times D \times (1-D)$$

$$(EQ. 27) \quad R_I = G_I \times R_S$$

- $R_O$  is the load resistor
- $C_O$  is the output capacitor
- $L$  is the inductor
- $R_S$  is the current sense resistor
- $V_O$  is the output voltage
- $T_S$  is the period of one switching cycle
- $D$  is the duty cycle of lower MOSFET
- $V_{SL} = 0.843V$ , is the slope compensation voltage

- $V_{IN}$  is the input voltage of the boost
- $V_C$  is the output of the error amplifier
- $G_1 = 5.472$ , is the gain of the current sensor

The low frequency pole frequency is shown in [Equation 28](#).

$$(EQ. 28) \quad \omega_{p0} = 2\pi f_{p0} = \frac{K_d}{C_o \times R_o}$$

The high frequency pole frequency is shown in [Equation 29](#).

$$(EQ. 29) \quad \omega_{pi} = 2\pi f_{pi} = \frac{K_m \times R_l}{L}$$

The output capacitor ESR ( $R_{ESR}$ ) zero frequency is shown in [Equation 30](#).

$$(EQ. 30) \quad \omega_{z(esr)} = 2\pi f_{z(esr)} = \frac{1}{C_o \times R_{ESR}}$$

The output voltage is regulated by an error amplifier EA. The EA compensation network parameters can be determined by compensating the current loop poles and zero so as to implement an ideal -20dB/decade close-loop gain with around 1/50~1/20 of  $f_{SW}$  crossover frequency.

For boost topology, the maximum crossover frequency is also limited by the RHPZ. Estimate the RHPZ at the minimum input voltage by [Equation 31](#).

$$(EQ. 31) \quad \omega_{RHPZ} = 2\pi f_{RHPZ} = \frac{R}{L} \times (1 - D_{max})^2$$

If the crossover frequency  $f_c \ll f_{pi}$ , a type-2 compensation network is enough to achieve the goal.

The type-2 EA amplifier transfer function is simplified to [Equation 32](#).

$$(EQ. 32) \quad \frac{\hat{V}_c}{\hat{V}_o} = \frac{R_2}{R_1 + R_2} \cdot g_m \cdot \frac{1 + sR_3C_2}{s(C_2 + C_3) + s^2R_3C_2C_3} = \frac{R_2}{R_1 + R_2} \cdot \frac{g_m}{C_2 + C_3} \cdot \frac{1 + sR_3C_2}{s \left( 1 + \frac{sR_3C_2C_3}{C_2 + C_3} \right)}$$

To simplify the model, assuming  $C_3 \ll C_2$ , the type-2 EA amplifier transfer function is simplified to [Equation 32](#).

$$(EQ. 33) \quad \frac{\hat{V}_c}{\hat{V}_o} = \frac{R_2}{R_1 + R_2} \cdot \frac{g_m}{C_2 + C_3} \cdot \frac{1 + sR_3C_2}{s(1 + sR_3C_3)}$$

where  $g_m$  is the gain of error amplifier, typical 1.75mS.

The transfer function has one pole and one zero.

- The pole is at the frequency of  $f_{p1} = 1/2\pi R_3 C_3$ . This is the frequency where the impedance of  $R_3$  is equal to  $C_3$ .
- The zero is at the frequency of  $f_{z1} = 1/2\pi R_3 C_2$ . This is the frequency where the impedance of  $R_3$  is equal to  $C_2$ .

To achieve ideal compensation, Renesas recommends making  $f_{z1} = f_{p0}$  and  $f_{p1} = f_{z(esr)}$  as shown in [Figure 14](#).

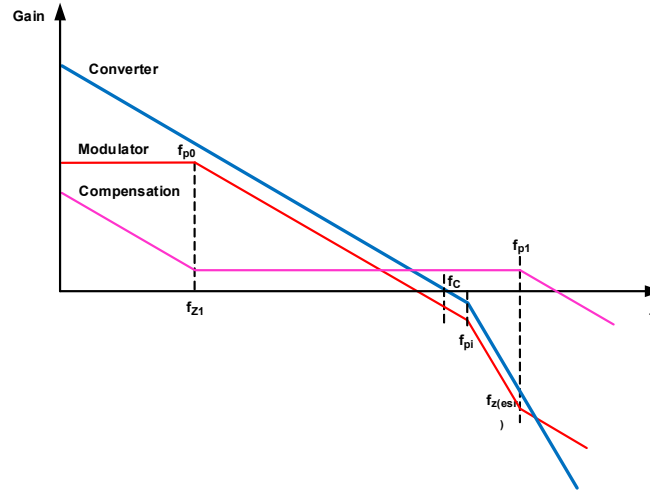

Figure 14. Feedback Loop Compensation

The close-loop transfer function is then simplified to Equation 34.

$$(EQ. 34) \quad G_{loop}(s) = \frac{R_O \times (1-D)}{R_I \times K_d} \times \frac{\left(1 - \frac{s}{\omega_{RHPZ}}\right) \left(1 + \frac{s}{\omega_{z(esr)}}\right)}{\left(1 + \frac{s}{\omega_{p0}}\right) \left(1 + \frac{s}{\omega_{pi}}\right)} \times \left(-\frac{R_2}{R_1 + R_2} \cdot \frac{g_m}{C_2 + C_3}\right) \cdot \frac{1 + sR_3C_2}{s(1 + sR_3C_3)}$$

The Loop design example for the 48V output under 20V input voltage is shown in the following:

$V_{IN} = 20V$ ,  $V_{OUT} = 48V$ ,  $I_{OUT} = 3A$ ,  $f_{sw} = 200kHz$ ,  $T_s = 5\mu s$ ,  $D = 1 - V_{IN} / V_{OUT} = 0.588$ ,  $L = 10\mu H$ ,  $C_O = 238.8\mu F$  ( $220\mu F + 4.7\mu F \times 4$ ),  $R_O = V_{OUT} / I_{OUT} = 16\Omega$ ,  $R_s = 4m\Omega$ ,  $R_{esr} = 10m\Omega$ .

$$(EQ. 35) \quad K_m = \frac{1}{(D-0.5)R_I \times \frac{T_s}{L} + \frac{V_{SL}}{V_O}} = \frac{1}{(0.588-0.5)(4m\Omega \times 5.472) \times \frac{5\mu s}{10\mu H} + \frac{0.843V}{48V}} = 53.98$$

$$(EQ. 36) \quad K_d = 2 + \frac{R_O \cdot (1-D)^2}{R_I} \cdot \left(\frac{1}{K_m} + \frac{K}{1-D}\right) = 2 + \frac{16 \cdot (1-0.588)^2}{4m\Omega \times 5.472} \cdot \left(\frac{1}{53.98} + 0.5 \times 4m\Omega \times 5.472 \times \frac{5\mu s}{10\mu H} \times 0.588\right) = 4.7$$

$$(EQ. 37) \quad \omega_{p0} = \frac{K_d}{C_O \times R_O} = \frac{4.7}{238.8\mu F \times 16\Omega} = 1.23kHz$$

$$(EQ. 38) \quad f_{p0} = \frac{\omega_{p0}}{2\pi} = 0.196kHz$$

$$(EQ. 39) \quad \omega_{pi} = \frac{K_m \times R_I}{L} = \frac{53.98 \times 0.022\Omega}{10\mu H} = 118.8kHz$$

$$(EQ. 40) \quad f_{pi} = \frac{\omega_{pi}}{2\pi} = 18.9kHz$$

$$(EQ. 41) \quad \omega_{z(esr)} = \frac{1}{C_O \times R_{ESR}} = \frac{1}{238.8\mu F \times 10m\Omega} = 418.8kHz$$

$$(EQ. 42) \quad f_{z(esr)} = \frac{\omega_{z(esr)}}{2\pi} = 66.66kHz$$

The minimum value of RHPZ can be calculate using Equation 43.

$$(EQ. 43) \quad f_{RHPZ} = \frac{R_O}{2\pi \times L} \times (1 - D_{max})^2 = \frac{16\Omega}{2\pi \times 10\mu H} \times \left(\frac{12V}{48V}\right)^2 = 15.92kHz$$

Therefore, make  $0.1 \times f_{RHPZ}$  as crossover frequency and make the gain -20dB/decade:

$$(EQ. 44) \quad f_c = 0.1 \times f_{RHPZ} = 1.59kHz$$

If  $R_3$  (R18) = 10k, set the frequency of this zero  $f_{z1} = f_{p0}$ , then  $C_2$  (C17) is calculated using Equation 45.

$$(EQ. 45) \quad C_2 = \frac{1}{2\pi R_3 f_{p0}} = \frac{1}{2\pi \times 10k\Omega \times 0.196kHz} = 81.2nF$$

Select a standard value capacitor  $C_2$  (C17) = 82nF.

Set the frequency of this pole  $f_{p1} = f_{z(esr)}$ , and should make sure  $f_c \ll f_{p1} \ll f_{sw}$ . Then  $C_3$  (C15) is calculated using Equation 46.

$$(EQ. 46) \quad C_3 = \frac{1}{2\pi R_3 f_{z(esr)}} = \frac{1}{2\pi \times 10k\Omega \times 66.66kHz} = 238.8pF$$

Select a standard value capacitor  $C_3$  (C15) = 220pF.

### 3. Typical Performance Curves

$V_{IN} = 12V, V_{OUT} = 48V, T_A = 25^\circ C$ , unless otherwise noted.

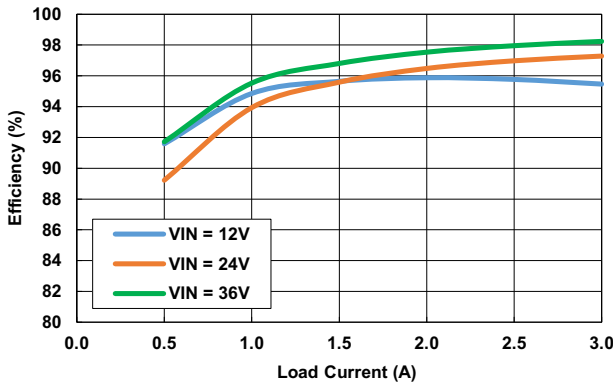

Figure 15. 48V Output Efficiency, CCM

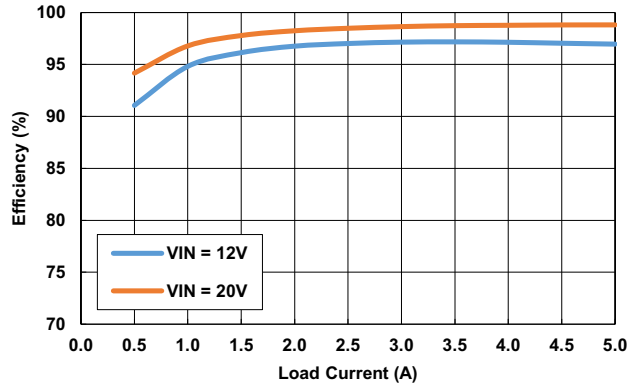

Figure 16. 24V Output Efficiency, CCM

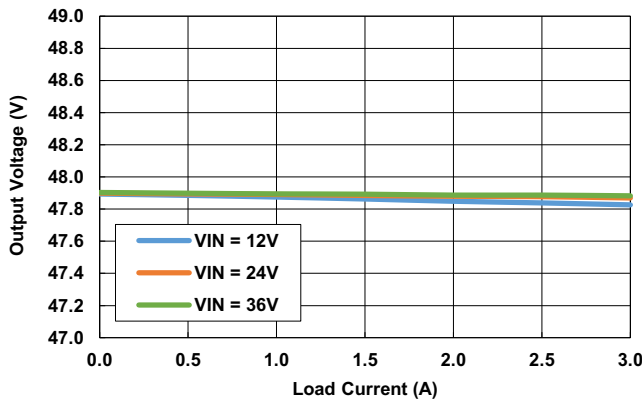

Figure 17. 48V Output Load Regulation, CCM

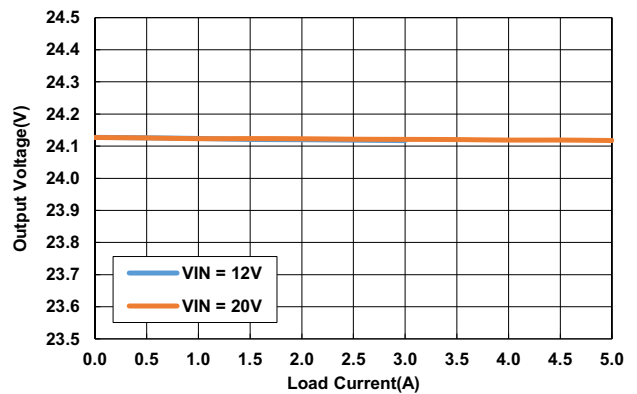

Figure 18. 24V Output Load Regulation, CCM

$V_{IN} = 12V$ ,  $V_{OUT1} = 48V$ ,  $V_{OUT2} = 24V$ ,  $T_A = 25^\circ C$ , unless otherwise noted. (Cont.)

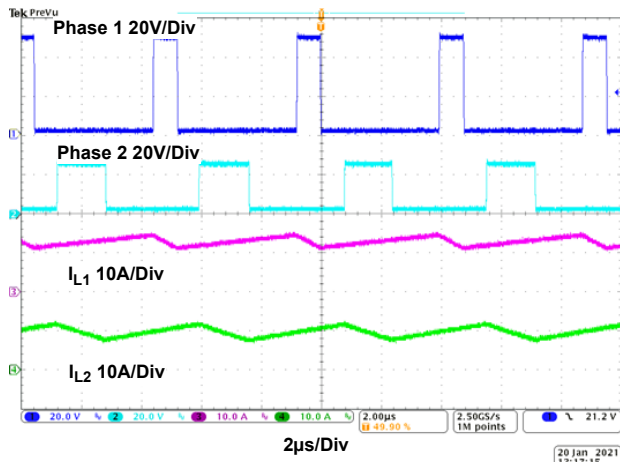

Figure 19.  $V_{IN} = 9V$ ,  $V_{OUT1} = 48V$ ,  $V_{OUT2} = 24V$ ,  $I_{OUT1} = 2A$ ,  $I_{OUT2} = 3A$ , CCM

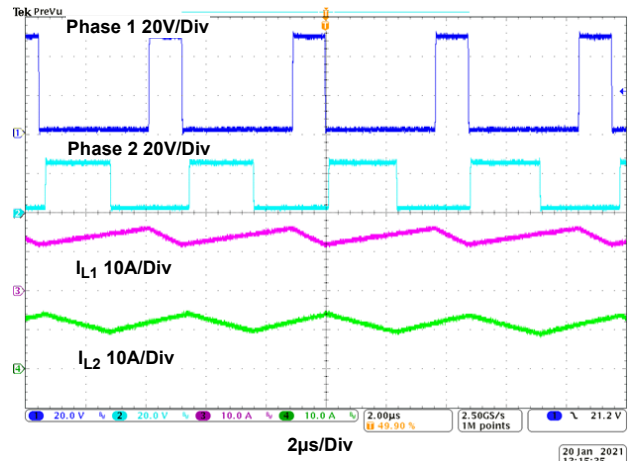

Figure 20.  $V_{IN} = 12V$ ,  $V_{OUT1} = 48V$ ,  $V_{OUT2} = 24V$ ,  $I_{OUT1} = 3A$ ,  $I_{OUT2} = 5A$ , CCM

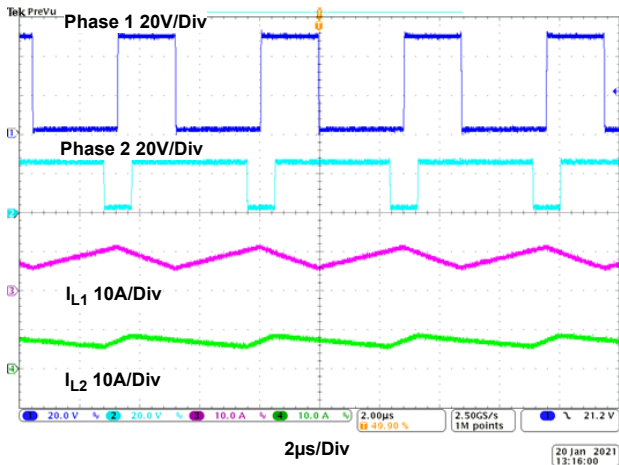

Figure 21.  $V_{IN} = 20V$ ,  $V_{OUT1} = 48V$ ,  $V_{OUT2} = 24V$ ,  $I_{OUT1} = 3A$ ,  $I_{OUT2} = 5A$ , CCM

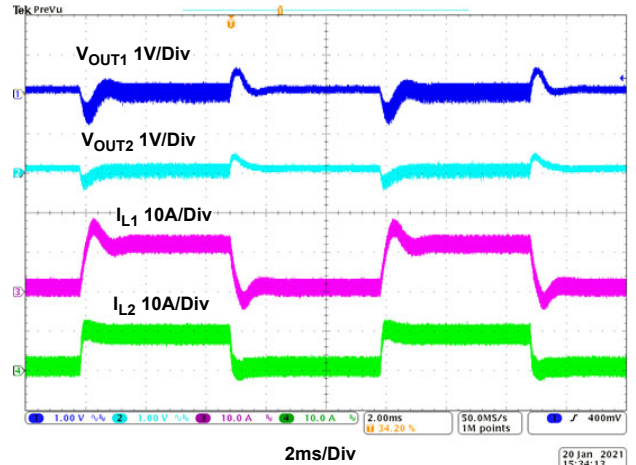

Figure 22. Load Transient,  $V_{IN} = 9V$ ,  $V_{OUT1} = 48V$ ,  $V_{OUT2} = 24V$ ,  $I_{OUT1} = 0A$  to  $2A$ ,  $I_{OUT2} = 0A$  to  $3A$ ,  $2.5A/\mu s$ , CCM

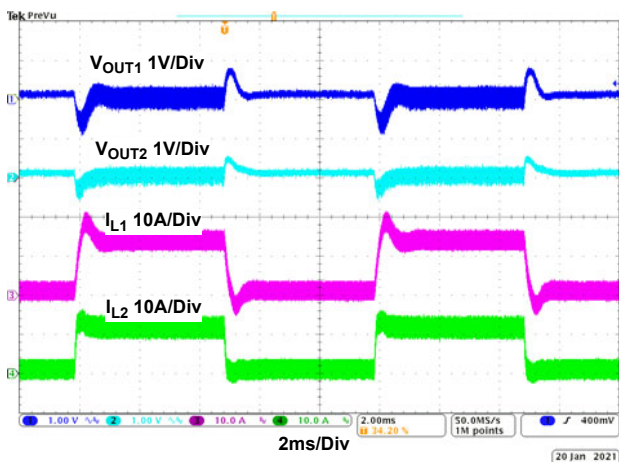

Figure 23. Load Transient,  $V_{IN} = 12V$ ,  $V_{OUT1} = 48V$ ,  $V_{OUT2} = 24V$ ,  $I_{OUT1} = 0A$  to  $3A$ ,  $I_{OUT2} = 0A$  to  $5A$ ,  $2.5A/\mu s$ , CCM

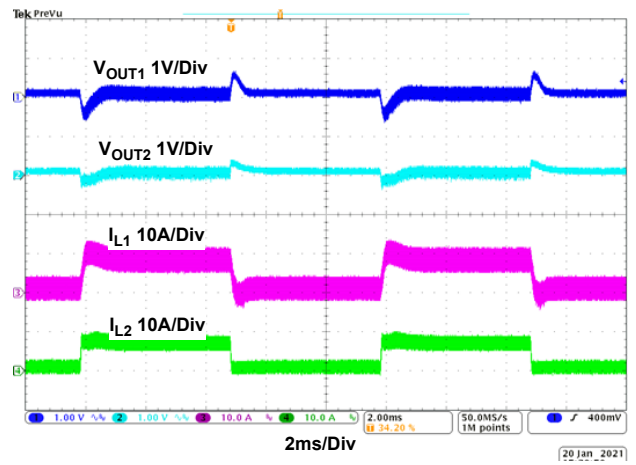

Figure 24. Load Transient,  $V_{IN} = 20V$ ,  $V_{OUT1} = 48V$ ,  $V_{OUT2} = 24V$ ,  $I_{OUT1} = 0A$  to  $3A$ ,  $I_{OUT2} = 0A$  to  $5A$ ,  $2.5A/\mu s$ , CCM

$V_{IN} = 12V$ ,  $V_{OUT} = 48V$ ,  $T_A = 25^\circ C$ , unless otherwise noted. (Cont.)

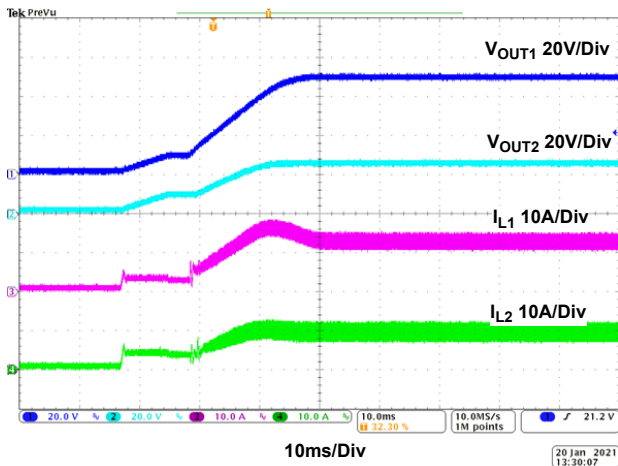

Figure 25. Start-Up Waveform,  $V_{IN} = 9V$ ,  $V_{OUT1} = 48V$ ,  $V_{OUT2} = 24V$ ,  $I_{OUT1} = 2A$ ,  $I_{OUT2} = 3A$ , CCM

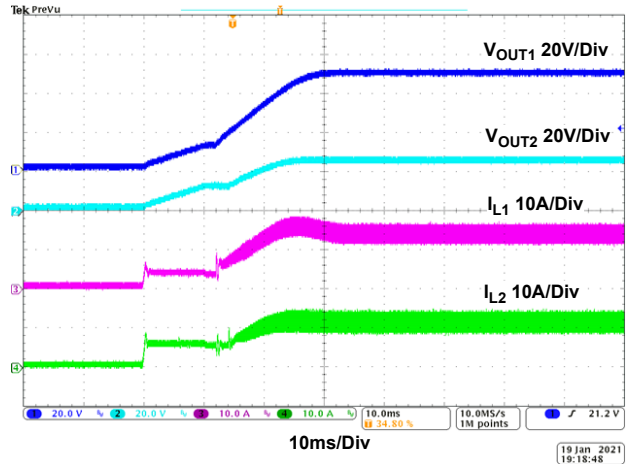

Figure 26. Start-Up Waveform,  $V_{IN} = 12V$ ,  $V_{OUT1} = 48V$ ,  $V_{OUT2} = 24V$ ,  $I_{OUT1} = 3A$ ,  $I_{OUT2} = 5A$ , CCM

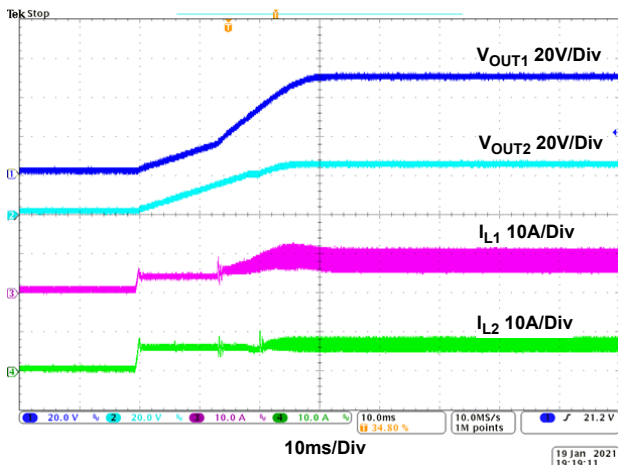

Figure 27. Start-Up Waveform,  $V_{IN} = 20V$ ,  $V_{OUT1} = 48V$ ,  $V_{OUT2} = 24V$ ,  $I_{OUT1} = 3A$ ,  $I_{OUT2} = 5A$ , CCM

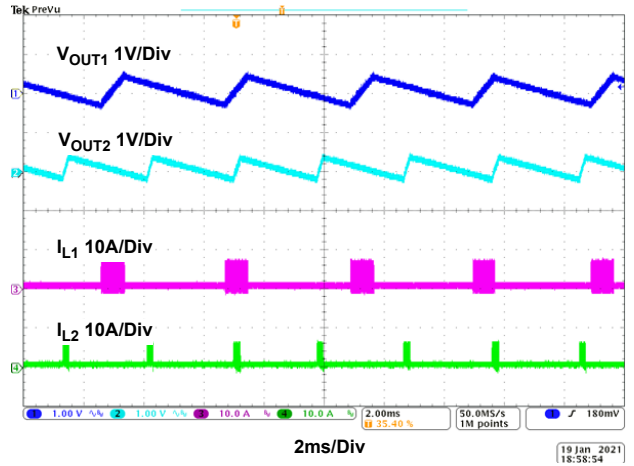

Figure 28. Burst Mode Waveform,  $V_{IN} = 12V$ ,  $I_{OUT1} = 0.1A$ ,  $I_{OUT2} = 0.1A$

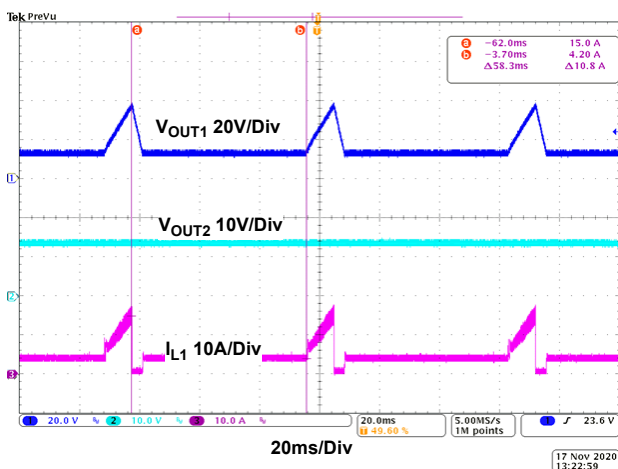

Figure 29. 48V Output OCP Response, HICCUP Mode,  $V_{IN} = 12V$

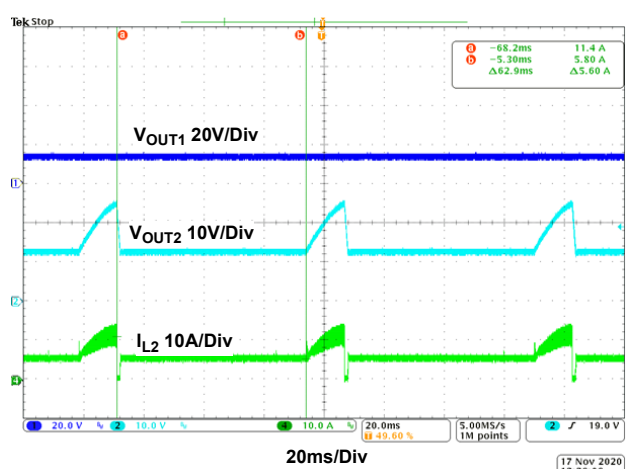

Figure 30. 24V Output OCP Response, HICCUP Mode,  $V_{IN} = 12V$



$V_{IN} = 12V$ ,  $V_{OUT} = 48V$ ,  $T_A = 25^\circ C$ , unless otherwise noted. (Cont.)

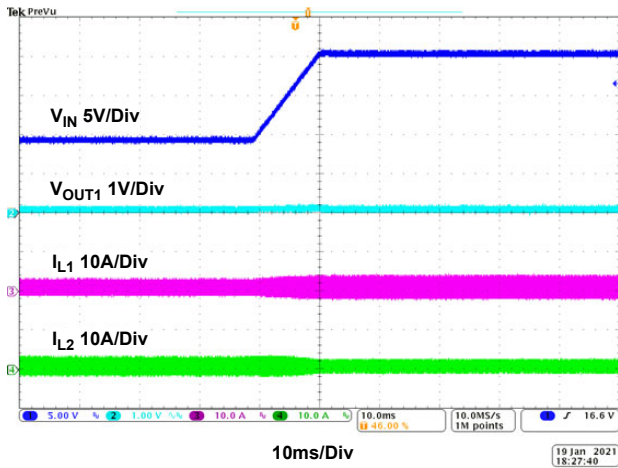

Figure 31. Line Transient,  $V_{IN1} = V_{IN2} = 9V$  to  $20V$ ,  $1V/ms$ ,  
 $I_{OUT1} = I_{OUT2} = 0A$

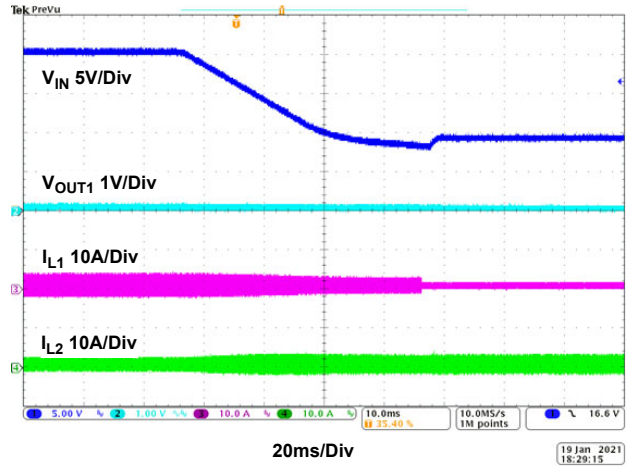

Figure 32. Line Transient,  $V_{IN1} = V_{IN2} = 20V$  to  $9V$ ,  $1V/ms$ ,  
 $I_{OUT1} = I_{OUT2} = 0A$

## 4. Ordering Information

Part Number	Description
ISL81805EVAL2Z	High Voltage Dual Boost Controller Evaluation Board

## 5. Revision History

Rev.	Date	Description
1.00	Sep 14, 2021	initial release.

## IMPORTANT NOTICE AND DISCLAIMER

RENESAS ELECTRONICS CORPORATION AND ITS SUBSIDIARIES (“RENESAS”) PROVIDES TECHNICAL SPECIFICATIONS AND RELIABILITY DATA (INCLUDING DATASHEETS), DESIGN RESOURCES (INCLUDING REFERENCE DESIGNS), APPLICATION OR OTHER DESIGN ADVICE, WEB TOOLS, SAFETY INFORMATION, AND OTHER RESOURCES “AS IS” AND WITH ALL FAULTS, AND DISCLAIMS ALL WARRANTIES, EXPRESS OR IMPLIED, INCLUDING, WITHOUT LIMITATION, ANY IMPLIED WARRANTIES OF MERCHANTABILITY, FITNESS FOR A PARTICULAR PURPOSE, OR NON-INFRINGEMENT OF THIRD PARTY INTELLECTUAL PROPERTY RIGHTS.

These resources are intended for developers skilled in the art designing with Renesas products. You are solely responsible for (1) selecting the appropriate products for your application, (2) designing, validating, and testing your application, and (3) ensuring your application meets applicable standards, and any other safety, security, or other requirements. These resources are subject to change without notice. Renesas grants you permission to use these resources only for development of an application that uses Renesas products. Other reproduction or use of these resources is strictly prohibited. No license is granted to any other Renesas intellectual property or to any third party intellectual property. Renesas disclaims responsibility for, and you will fully indemnify Renesas and its representatives against, any claims, damages, costs, losses, or liabilities arising out of your use of these resources. Renesas' products are provided only subject to Renesas' Terms and Conditions of Sale or other applicable terms agreed to in writing. No use of any Renesas resources expands or otherwise alters any applicable warranties or warranty disclaimers for these products.

(Rev.1.0 Mar 2020)

### Corporate Headquarters

TOYOSU FORESIA, 3-2-24 Toyosu,  
Koto-ku, Tokyo 135-0061, Japan  
[www.renesas.com](http://www.renesas.com)

### Contact Information

For further information on a product, technology, the most up-to-date version of a document, or your nearest sales office, please visit:  
[www.renesas.com/contact/](http://www.renesas.com/contact/)

### Trademarks

Renesas and the Renesas logo are trademarks of Renesas Electronics Corporation. All trademarks and registered trademarks are the property of their respective owners.