

ISL85403DEMO1Z

Demonstration Board

AN1960
Rev 1.00
Mar 13, 2015

Description

The ISL85403DEMO1Z board allows quick evaluation of the ISL85403 in the synchronous buck configuration. It also demonstrates the compact size solution for the wide input voltage range point-of-load DC/DC converter using ISL85403.

Specifications

The design specifications of the ISL85403DEMO1Z are shown in [Table 1](#).

TABLE 1. SPECIFICATIONS

PARAMETERS	VALUES
Input Voltage (VIN)	7V to 40V
Output Voltage (VOUT)	5.0V
Max. Output Current (IOUT_MAX)	2.5A
Switching Frequency	500kHz
Output Ripple	50mV at 2.5A Load
Peak Efficiency	93% at 50% Load, 12V Input

Key Features

- Small, compact design
- VIN range of 7V to 40V
- VOUT adjustable from 0.8V to 5V
- Convenient power connection

References

[ISL85403 Datasheet](#)

Ordering Information

PART NUMBER	DESCRIPTION
ISL85403DEMO1Z	ISL85403 Evaluation kit, synchronous buck configuration 5V output

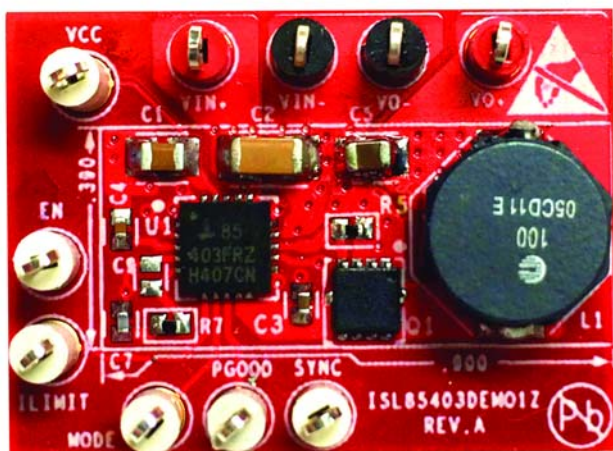

FIGURE 1. TOP VIEW

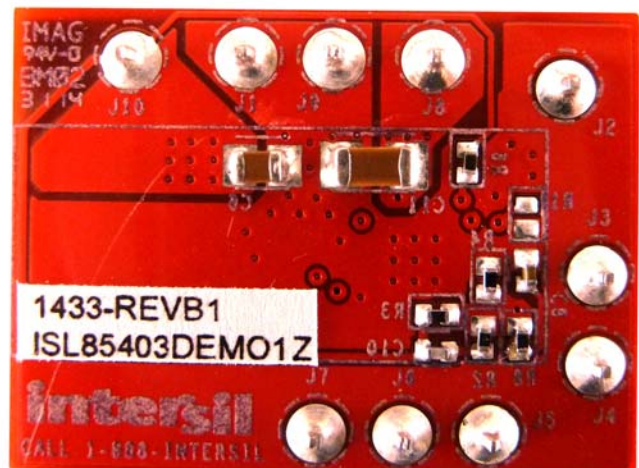

FIGURE 2. BOTTOM VIEW

Functional Description

The ISL85403 is a flexible switching regulator with an integrated 127mΩ high-side MOSFET. It can be used as a synchronous buck converter, a 2-stage boost-buck converter, or a noninverting buck-boost converter.

The ISL85403DEMO1Z board demonstrates the compact size and operations of the ISL85403 in the synchronous buck configuration. The ISL85403DEMO1Z board is shown in [Figures 1](#) and [2](#).

The schematic is shown on [page 3](#), bill of materials on [page 4](#), and PCB layers for reference start on [page 7](#). [Figures 4](#) through [12](#) show performance data taken from the demo board.

Operating Range

The board input voltage range is 7V to 40V. The output voltage is set to 5V and can be changed by voltage feedback resistors R_3 and R_4 , as shown in [Equation 1](#):

$$R_4 = R_3 \cdot \frac{V_{ref}}{V_{out} - V_{ref}} \quad (\text{EQ. 1})$$

NOTE: In order to change to a higher output voltage, the output capacitors have to be changed for the higher voltage rating.

The board is set to a default frequency of 500kHz (FS pin/ R_1 is open). The switching frequency can be programmed to other values by a resistor at R_1 . Refer to the [ISL85403](#) datasheet for the resistor value and the switching frequency. The switching frequency can also be synchronized to external clock by connecting the external clock to the SYNC terminal (J7).

PCB Layout Guidelines

1. Place the input ceramic capacitors as closely as possible to the IC VIN pin and power ground connecting to the power MOSFET or Diode. Keep this loop (input ceramic capacitor, IC VIN pin and MOSFET/Diode) as tiny as possible to minimize the voltage spikes induced by the trace parasitic inductance.
2. Keep the phase node copper area small but large enough to handle the load current.
3. Place the output ceramic and aluminum capacitors close to the power stage components as well.
4. Place vias (at least 9) in the bottom pad of the IC. The bottom pad should be placed in ground copper plane with an area as large as possible in multiple layers to effectively reduce the thermal impedance.
5. Place the 4.7μF ceramic decoupling capacitor at the VCC pin (the closest place to the IC). Put multiple vias close to the ground pad of this capacitor.
6. Keep the bootstrap capacitor close to the IC.
7. Keep the LGATE drive trace as short as possible and try to avoid using via in the LGATE drive path to achieve the lowest impedance.
8. Place the output voltage sense trace close to the place that is to be strictly regulated.
9. Place all the peripheral control components close to the IC.

Quick Test Setup

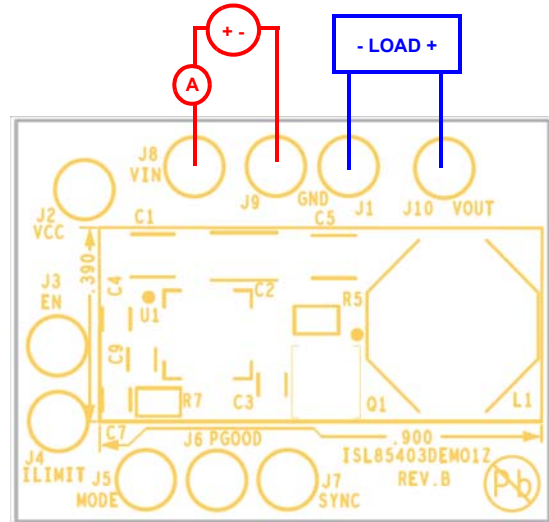

FIGURE 3. ISL85403DEMO1Z BOARD SETUP

1. If PWM mode is desired, connect test point MODE (J5) to ground. Otherwise leave the J5 open for PFM mode.
2. Connect the power supply to the input terminals VIN (J8) and GND (J9). Connect the load terminals to the buck outputs VOUT (J10) and GND (J11). Make sure the setup is correct prior to applying any power or load to the board.
3. Adjust the power supply to 12V and turn it on.
4. Verify the output voltage is 5V and use oscilloscope to monitor the phase node waveforms.

Bill of Materials

REF DES	PART NUMBER	QTY	DESCRIPTION	MANUFACTURER
C9		0	DNP	
C7, C10	VARIOUS	2	CAP, SMD, 0402, 150pF, 50V, 10%, COG, ROHS	VARIOUS
C3	ECJ-OEBOJ105M	1	CAP, SMD, 0402, 1 μ F, 6.3V, 20%, X5R, ROHS	PANASONIC
C4	VARIOUS	1	CAP, SMD, 0402, 0.015 μ F, 16V, 10%, X7R, ROHS	VARIOUS
C8	VARIOUS	1	CAP, SMD, 0402, 470pF, 50V, 10%, X7R, ROHS	VARIOUS
C5, C6	GRM21BR71A106KE51K	2	CAP, SMD, 0805, 10 μ F, 10V, 10%, X7R, ROHS	Murata
C1	GRM21BR71A475KA73L	1	CAP, SMD, 0805, 4.7 μ F, 10V, 10%, X7R, ROHS	Murata
C2, C11	C3216X5R1H106K	2	CAP, SMD, 1206, 10 μ F, 50V, 10%, X5R, ROHS	TDK
L1	SD8350-100-R	1	COIL-PWR INDUCTOR, SMD, 9.5x8.3, 10 μ H, 20%, 4A, 31.4m Ω , ROHS	COILTRONICS
U1	ISL85403IRZ	1	IC-SWITCHING REGULATOR, 20P, QFN, 4X4, ROHS	INTERSIL
Q1	NTTFS5826NLTAG	1	TRANSIST-MOS, N-CHANNEL, 8P, PG-TSDSON-8, 60V, 8A, ROHS	ON SEMI
R2	VARIOUS	1	RES, SMD, 0402, 3.92k, 1/16W, 1%, TF, ROHS	VARIOUS
R3	VARIOUS	1	RES, SMD, 0402, 232k, 1/16W, 1%, TF, ROHS	VARIOUS
R7	VARIOUS	1	RES, SMD, 0402, 2k, 1/16W, 1%, TF, ROHS	VARIOUS
R4	ERJ-2RKF4422X	1	RES, SMD, 0402, 44.2k, 1/16W, 1%, TF, ROHS	VARIOUS
R5	VARIOUS	1	RES, SMD, 0402, 4.7k, 1/16W, 1%, TF, ROHS	VARIOUS
R6	VARIOUS	1	RES, SMD, 0402, 0 Ω , 1/16W, 1%, TF, ROHS	VARIOUS
R1	N/A	0	Do not populate	N/A

Typical Performance Curves

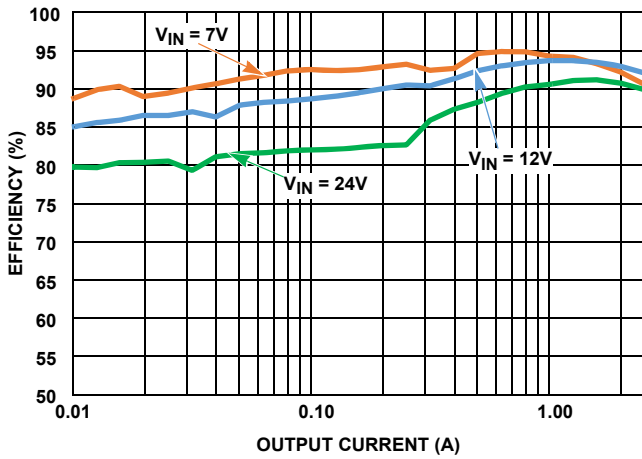

FIGURE 4. EFFICIENCY vs LOAD

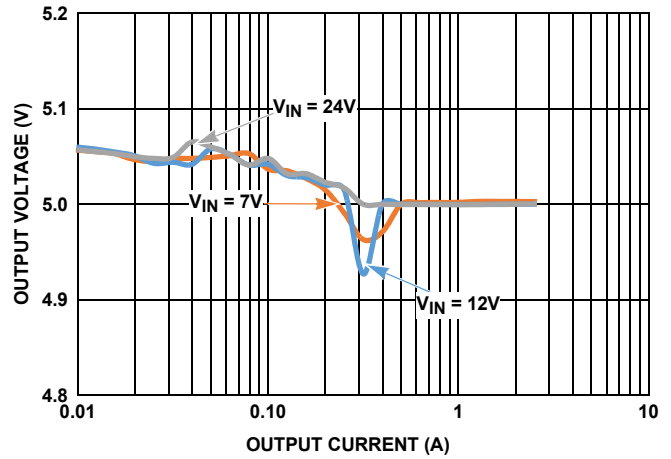

FIGURE 5. LINE REGULATION

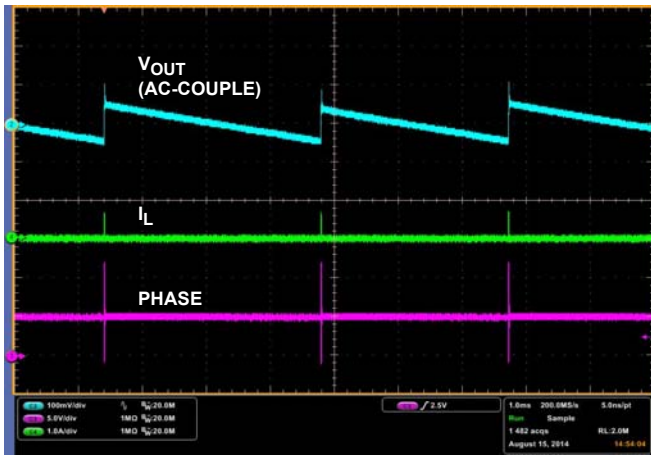

FIGURE 6. OUTPUT RIPPLE AT 0A LOAD

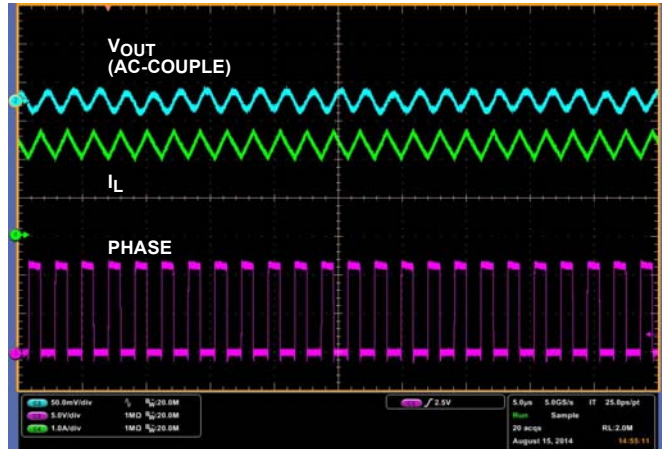

FIGURE 7. OUTPUT RIPPLE AT 2.5A LOAD

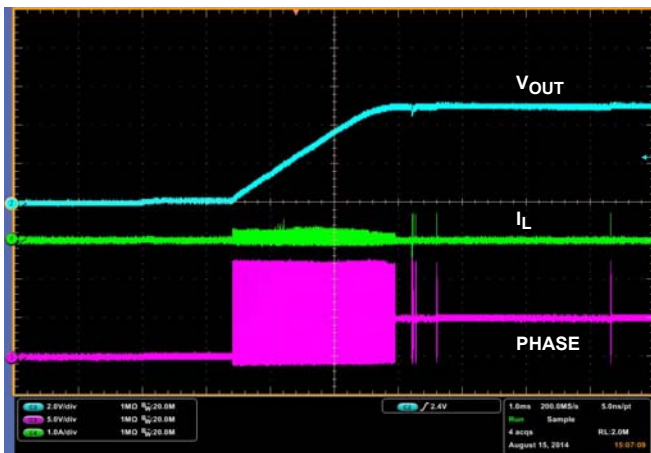

FIGURE 8. SOFT-START AT 0A LOAD

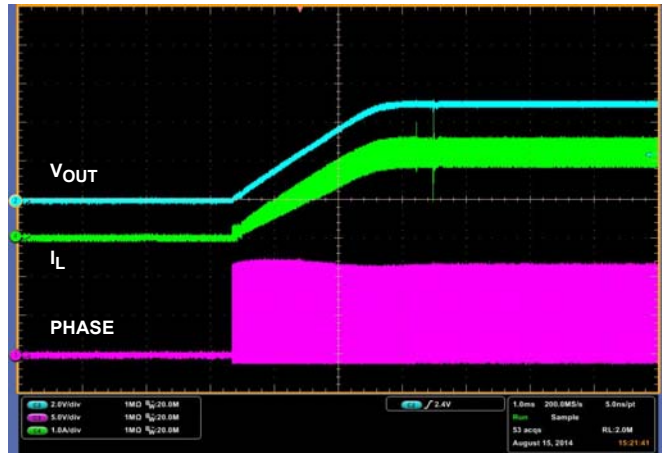

FIGURE 9. SOFT-START AT 2.5A LOAD

Typical Performance Curves (Continued)

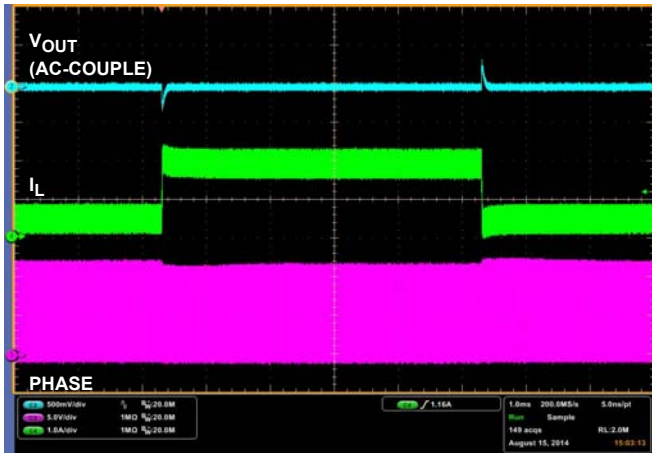

FIGURE 10. LOAD TRANSIENT RESPONSE

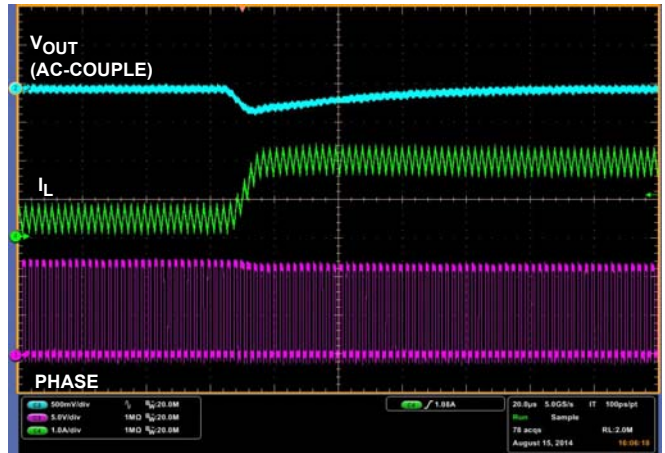

FIGURE 11. LOAD TRANSIENT RESPONSE



FIGURE 12. LOAD TRANSIENT RESPONSE

Board Layout

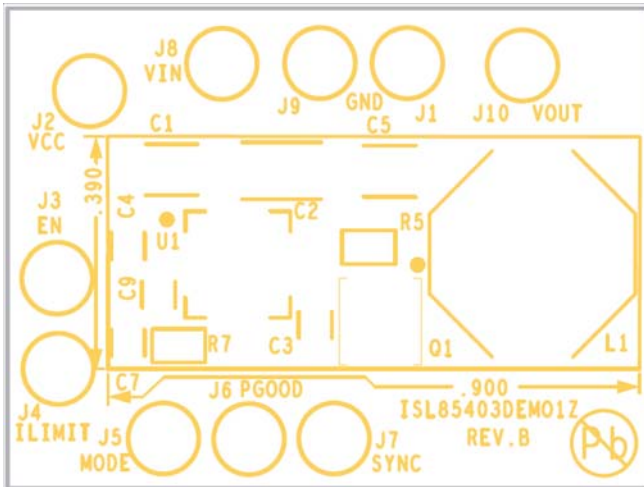

FIGURE 13. SILKSCREEN TOP COMPONENTS

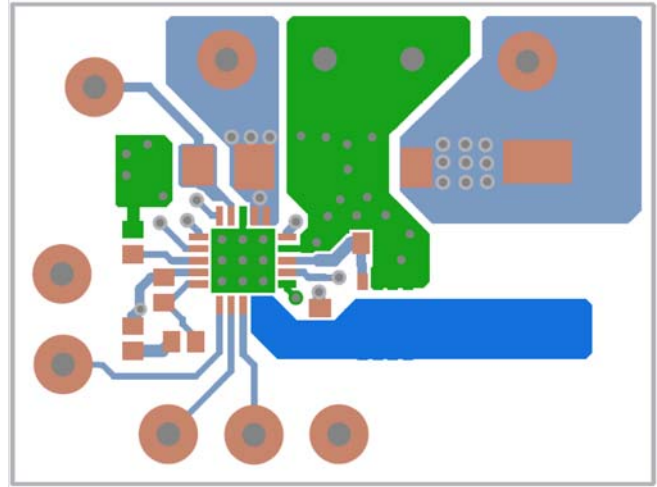

FIGURE 14. TOP LAYER

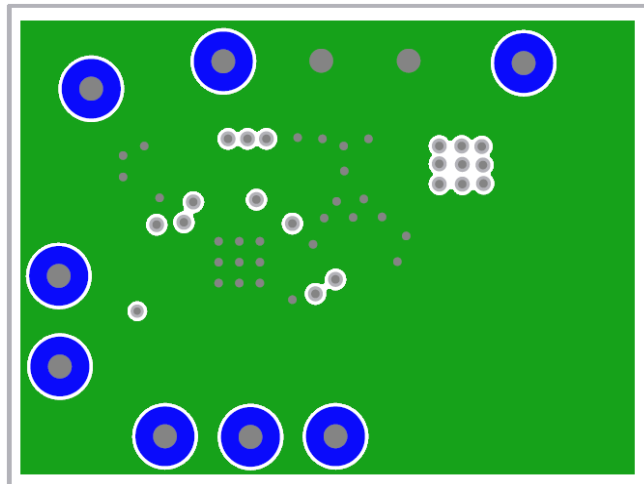

FIGURE 15. 2nd LAYER

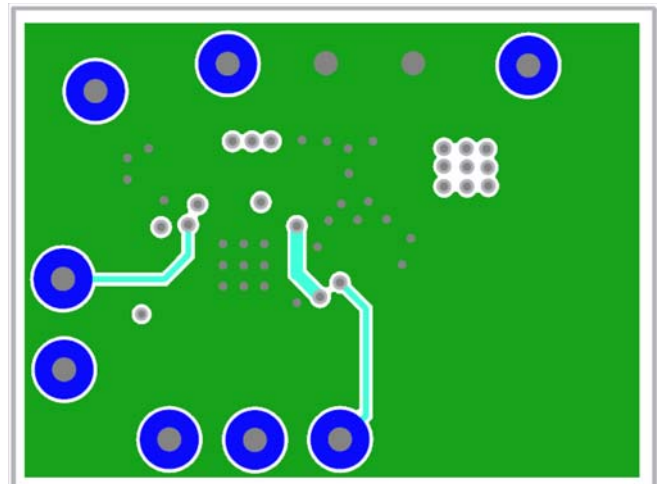

FIGURE 16. 3rd LAYER

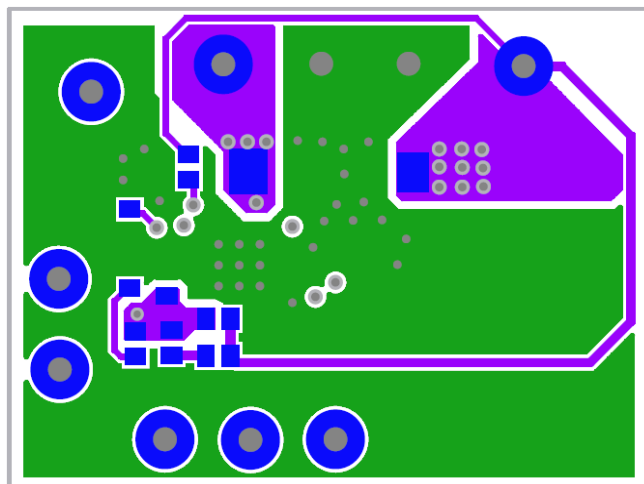

FIGURE 17. BOTTOM LAYER

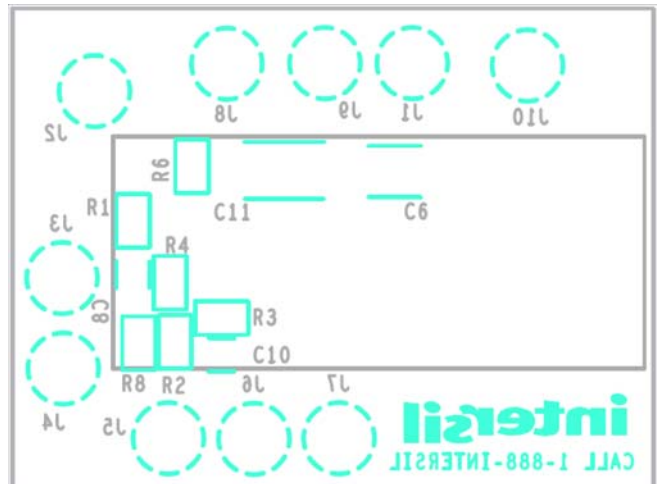

FIGURE 18. SILKSCREEN BOTTOM COMPONENTS

Board Layout (Continued)

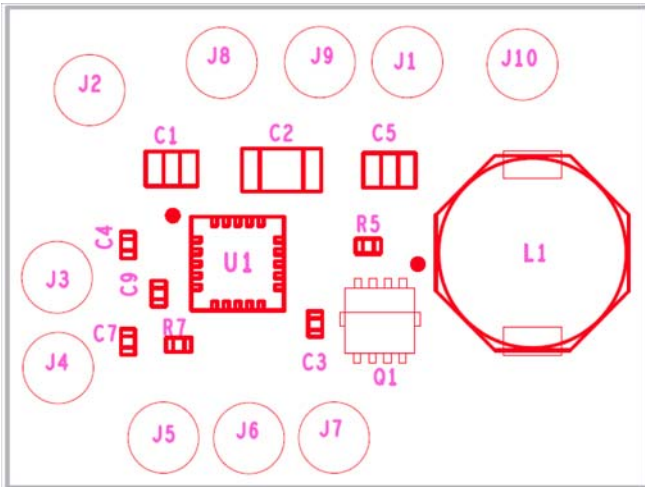

FIGURE 19. TOP COMPONENT ASSEMBLY

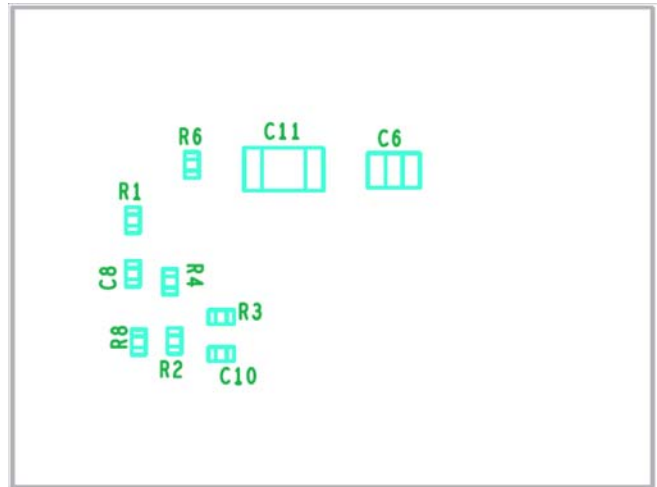

FIGURE 20. BOTTOM COMPONENT ASSEMBLY (MIRRORED)

Notice

1. Descriptions of circuits, software and other related information in this document are provided only to illustrate the operation of semiconductor products and application examples. You are fully responsible for the incorporation or any other use of the circuits, software, and information in the design of your product or system. Renesas Electronics disclaims any and all liability for any losses and damages incurred by you or third parties arising from the use of these circuits, software, or information.
2. Renesas Electronics hereby expressly disclaims any warranties against and liability for infringement or any other claims involving patents, copyrights, or other intellectual property rights of third parties, by or arising from the use of Renesas Electronics products or technical information described in this document, including but not limited to, the product data, drawings, charts, programs, algorithms, and application examples.
3. No license, express, implied or otherwise, is granted hereby under any patents, copyrights or other intellectual property rights of Renesas Electronics or others.
4. You shall not alter, modify, copy, or reverse engineer any Renesas Electronics product, whether in whole or in part. Renesas Electronics disclaims any and all liability for any losses or damages incurred by you or third parties arising from such alteration, modification, copying or reverse engineering.
5. Renesas Electronics products are classified according to the following two quality grades: "Standard" and "High Quality". The intended applications for each Renesas Electronics product depends on the product's quality grade, as indicated below.
"Standard": Computers; office equipment; communications equipment; test and measurement equipment; audio and visual equipment; home electronic appliances; machine tools; personal electronic equipment; industrial robots; etc.
"High Quality": Transportation equipment (automobiles, trains, ships, etc.); traffic control (traffic lights); large-scale communication equipment; key financial terminal systems; safety control equipment; etc.
Unless expressly designated as a high reliability product or a product for harsh environments in a Renesas Electronics data sheet or other Renesas Electronics document, Renesas Electronics products are not intended or authorized for use in products or systems that may pose a direct threat to human life or bodily injury (artificial life support devices or systems; surgical implantations; etc.), or may cause serious property damage (space system; undersea repeaters; nuclear power control systems; aircraft control systems; key plant systems; military equipment; etc.). Renesas Electronics disclaims any and all liability for any damages or losses incurred by you or any third parties arising from the use of any Renesas Electronics product that is inconsistent with any Renesas Electronics data sheet, user's manual or other Renesas Electronics document.
6. When using Renesas Electronics products, refer to the latest product information (data sheets, user's manuals, application notes, "General Notes for Handling and Using Semiconductor Devices" in the reliability handbook, etc.), and ensure that usage conditions are within the ranges specified by Renesas Electronics with respect to maximum ratings, operating power supply voltage range, heat dissipation characteristics, installation, etc. Renesas Electronics disclaims any and all liability for any malfunctions, failure or accident arising out of the use of Renesas Electronics products outside of such specified ranges.
7. Although Renesas Electronics endeavors to improve the quality and reliability of Renesas Electronics products, semiconductor products have specific characteristics, such as the occurrence of failure at a certain rate and malfunctions under certain use conditions. Unless designated as a high reliability product or a product for harsh environments in a Renesas Electronics data sheet or other Renesas Electronics document, Renesas Electronics products are not subject to radiation resistance design. You are responsible for implementing safety measures to guard against the possibility of bodily injury, injury or damage caused by fire, and/or danger to the public in the event of a failure or malfunction of Renesas Electronics products, such as safety design for hardware and software, including but not limited to redundancy, fire control and malfunction prevention, appropriate treatment for aging degradation or any other appropriate measures. Because the evaluation of microcomputer software alone is very difficult and impractical, you are responsible for evaluating the safety of the final products or systems manufactured by you.
8. Please contact a Renesas Electronics sales office for details as to environmental matters such as the environmental compatibility of each Renesas Electronics product. You are responsible for carefully and sufficiently investigating applicable laws and regulations that regulate the inclusion or use of controlled substances, including without limitation, the EU RoHS Directive, and using Renesas Electronics products in compliance with all these applicable laws and regulations. Renesas Electronics disclaims any and all liability for damages or losses occurring as a result of your noncompliance with applicable laws and regulations.
9. Renesas Electronics products and technologies shall not be used for or incorporated into any products or systems whose manufacture, use, or sale is prohibited under any applicable domestic or foreign laws or regulations. You shall comply with any applicable export control laws and regulations promulgated and administered by the governments of any countries asserting jurisdiction over the parties or transactions.
10. It is the responsibility of the buyer or distributor of Renesas Electronics products, or any other party who distributes, disposes of, or otherwise sells or transfers the product to a third party, to notify such third party in advance of the contents and conditions set forth in this document.
11. This document shall not be reprinted, reproduced or duplicated in any form, in whole or in part, without prior written consent of Renesas Electronics.
12. Please contact a Renesas Electronics sales office if you have any questions regarding the information contained in this document or Renesas Electronics products.
(Note 1) "Renesas Electronics" as used in this document means Renesas Electronics Corporation and also includes its directly or indirectly controlled subsidiaries.
(Note 2) "Renesas Electronics product(s)" means any product developed or manufactured by or for Renesas Electronics.

(Rev.4.0-1 November 2017)



SALES OFFICES

Renesas Electronics Corporation

<http://www.renesas.com>

Refer to "<http://www.renesas.com/>" for the latest and detailed information.

Renesas Electronics America Inc.
1001 Murphy Ranch Road, Milpitas, CA 95035, U.S.A.
Tel: +1-408-432-8888, Fax: +1-408-434-5351

Renesas Electronics Canada Limited
9251 Yonge Street, Suite 8309 Richmond Hill, Ontario Canada L4C 9T3
Tel: +1-905-237-2004

Renesas Electronics Europe Limited
Dukes Meadow, Millboard Road, Bourne End, Buckinghamshire, SL8 5FH, U.K.
Tel: +44-1628-651-700, Fax: +44-1628-651-804

Renesas Electronics Europe GmbH
Arcadiastrasse 10, 40472 Düsseldorf, Germany
Tel: +49-211-6503-0, Fax: +49-211-6503-1327

Renesas Electronics (China) Co., Ltd.
Room 1709 Quantum Plaza, No.27 ZhichunLu, Haidian District, Beijing, 100191 P. R. China
Tel: +86-10-8235-1155, Fax: +86-10-8235-7679

Renesas Electronics (Shanghai) Co., Ltd.
Unit 301, Tower A, Central Towers, 555 Langao Road, Putuo District, Shanghai, 200333 P. R. China
Tel: +86-21-2226-0888, Fax: +86-21-2226-0999

Renesas Electronics Hong Kong Limited
Unit 1601-1611, 16/F., Tower 2, Grand Century Place, 193 Prince Edward Road West, Mongkok, Kowloon, Hong Kong
Tel: +852-2265-6688, Fax: +852-2886-9022

Renesas Electronics Taiwan Co., Ltd.
13F, No. 363, Fu Shing North Road, Taipei 10543, Taiwan
Tel: +886-2-8175-9600, Fax: +886-2-8175-9670

Renesas Electronics Singapore Pte. Ltd.
80 Bendemeer Road, Unit #06-02 Hyflux Innovation Centre, Singapore 339949
Tel: +65-6213-0200, Fax: +65-6213-0300

Renesas Electronics Malaysia Sdn.Bhd.
Unit 1207, Block B, Menara Amcorp, Amcorp Trade Centre, No. 18, Jln Persiaran Barat, 46050 Petaling Jaya, Selangor Darul Ehsan, Malaysia
Tel: +60-3-7955-9390, Fax: +60-3-7955-9510

Renesas Electronics India Pvt. Ltd.
No.777C, 100 Feet Road, HAL 2nd Stage, Indiranagar, Bangalore 560 038, India
Tel: +91-80-67208700, Fax: +91-80-67208777

Renesas Electronics Korea Co., Ltd.
17F, KAMCO Yangjae Tower, 262, Gangnam-daero, Gangnam-gu, Seoul, 06265 Korea
Tel: +82-2-558-3737, Fax: +82-2-558-5338