

ISL88550AEVAL1Z Kit

Synchronous Step Down Controller with Sourcing and Sinking LDO Regulator

AN1200
Rev 3.00
Jul 23, 2008

ISL88550A integrates a synchronous buck PWM controller to generate VDDQ, a sourcing and sinking LDO linear regulator to generate VTT, and a 10mA reference output buffer to generate VTTR. The buck controller drives two external N-Channel MOSFETs to generate output voltages down to 0.7V from a 2V to 25V input with output currents up to 15A. The LDO can sink or source up to 1.5A continuous and 2.5A peak current with fast response. Both the LDO output and the 10mA reference buffer output can be made to track the VREFIN voltage via a built-in resistive divider. These features make the ISL88550A ideally suited for DDR memory applications in desktops, notebooks and graphic cards.

The PWM controller in the ISL88550A uses constant-on-time PWM architecture with a programmable switching frequency of up to 600kHz. This control scheme handles wide input/output voltage ratios with ease and provides 100ns "instant-on" response to load transients while maintaining high efficiency and a relatively constant switching frequency. The ISL88550A offers full programmable UVP/OVP and skip mode options ideal in portable applications. Skip mode allows for improved efficiency at lighter loads.

The VTT and VTTR outputs track to within 1% of VREFIN/2. The high bandwidth of this LDO regulator allows excellent transient response without the need for bulk capacitors, thus reducing the cost and size.

Pinout

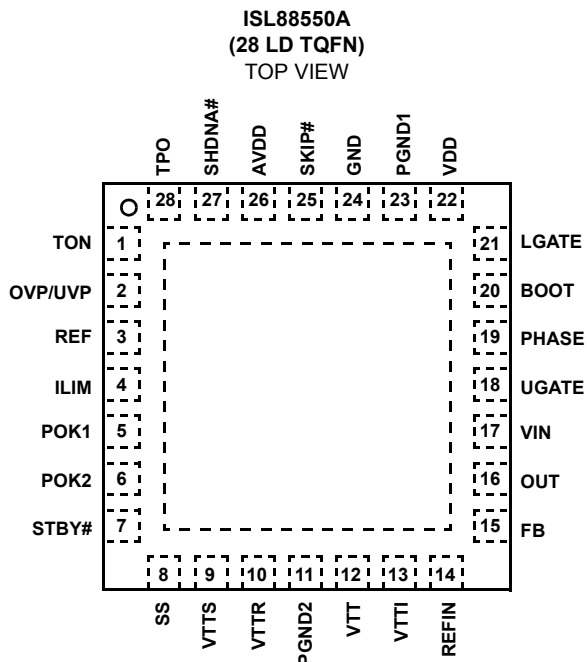

Features

Buck Controller

- Constant-On PWM with 100ns Load-Step Response
- Up to 95% Efficiency
- 2V to 25V Input Voltage Range
- 1.8V/2.5V fixed or 0.7V to 3.5V Adjustable Output
- 200kHz, 300kHz, 450kHz, 600kHz Switching Frequencies
- Programmable Current Limit with Foldback Capability
- 1.7ms Digital Soft-Start and Independent Shutdown
- Overvoltage/Undervoltage Protection Option
- Power-Good Window Comparator

LDO Section

- Fully Integrated VTT and VTTR Capability
- VTT has $\pm 2.5A$ Sourcing/Sinking Capability
- VTT and VTTR Outputs Track VREFIN/2
- VTT and VTTR within 1% of VREFIN/2
- All Ceramic Output Capacitor Designs
- 1.0V to 2.8V Input VREFIN Range
- Analog Soft-Start Option and Independent Shutdown
- Power-Good Window Comparator

Applications

- DDR I and DDR II Memory Power Supplies
- Desktop Computers
- Notebooks and Desksnotes
- Graphics Cards
- Game Consoles
- Networking and RAID

Ordering Information

PART	PACKAGE
ISL88550AEVAL1Z	Evaluation Board

What's Inside

The Evaluation Board Kit contains the following materials:

- The ISL88550AEVAL1Z REVA board
- The ISL88550A data sheet
- ISL88550AEVAL1Z Kit (this document)

Recommended Equipment

The following materials are recommended to perform testing:

- 0V to 22V power supply with at least 15A source current capability, battery, notebook AC-adaptor
- 5V Bias supply for VDD
- Two electronic loads capable of sinking current up to 15A
- Dummy loads for the LDO's
- Digital multimeters (DMMs)
- 100MHz quad-trace oscilloscope
- Signal generator

Quick Setup Guide

1. Ensure that the circuit is correctly connected to the supply and loads prior to applying any power.
2. Connect the bias supply to VDD, the + terminal to P3 (VDD) and - return to TP5 (AGND).
3. Verify that position 2's are ON for SW1, SW2, SW3, and SW5. Verify that position 1 is ON for SW4. Make sure that no other switch position is ON at the same time.
4. Turn on the VIN power supply.
5. Turn on 5V bias supply.
6. Verify the outputs voltages are 1.8V for VDDQ and 0.9V for VTT.

Evaluating the Other Output Voltage

The ISL88550EVAL1Z kit outputs are preset to 1.8V and 0.9V; however, VDDQ output voltage can be adjusted from 0.8V to 3.5V by using Equation 1:

$$R_{10} = (R_8 / [(V_{OUT}/V_{FB}) - 1]) \quad (\text{EQ. 1})$$

Set R8 to 25k Ω ; and VFB to 0.7V

VDDQ output can also be set to 2.5V by shorting FB pin to GND with R₁₀.

VTT output voltage is half on VDDQ in DDR application. VTTI can be powered directly from VDDQ. For better efficiency, VTTI can be powered from an external power supply. Make sure that R₁₃ is removed.

TABLE 1. SWITCH 1 SETTINGS

SW1	SKIP	OPERATING MODE
1	Connect to GND	Normal operation mode, allow automatic PWM/PFM switchover for pulse-skipping at light load.
2	Connect to AVDD	Low noise, fixed-frequency PWM mode.
3	No Connection	NA

NOTE: Only toggle one position at a time

TABLE 2. SWITCH 2 SETTINGS

SW2	SHDNA#	SHUTDOWN CONTROL
1	Connect to GND	Shutdown mode. VDDQ, VTTR, and VTT output.
2	Connect to AVDD	Enable ISL88550. Rising edge clear the fault protection. Connect to AVDD for normal operation.
3	No Connection	NA

NOTE: Only toggle one position at a time

TABLE 3. SWITCH 3 SETTINGS

SW3	t _{ON}	t _{ON} ON-TIME SELECTION
1	Connect to GND.	t _{ON} set to 600kHz frequency
2	Connect to AVDD.	t _{ON} set to 200kHz frequency
3	Connect to REF.	t _{ON} set to 450kHz frequency
-	OPEN	t _{ON} set to 300kHz frequency

NOTE: Only toggle one position at a time

TABLE 4. SWITCH 4 SETTINGS

SW4	OVP/UVP	FAULT PROTECTION CONTROL
1	Connect to GND	Disable OVP and UVP
2	Connect to AVDD	Enable OVP and UVP
3	Connect to REF	Disable OVP and enable UVP
-	OPEN	Enable OVP and disable UVP

NOTE: Only toggle one position at a time

TABLE 5. SWITCH 5 SETTINGS

SW5	STBY#	FAULT PROTECTION CONTROL
1	Connect to GND	Shutdown VTT in high impedance state. VTTR is still active.
2	Connect to V _{CC}	Enable VTT
3	No Connection	

NOTE: Only toggle one position at a time

ISL88550AEVAL1Z Schematic DDR II

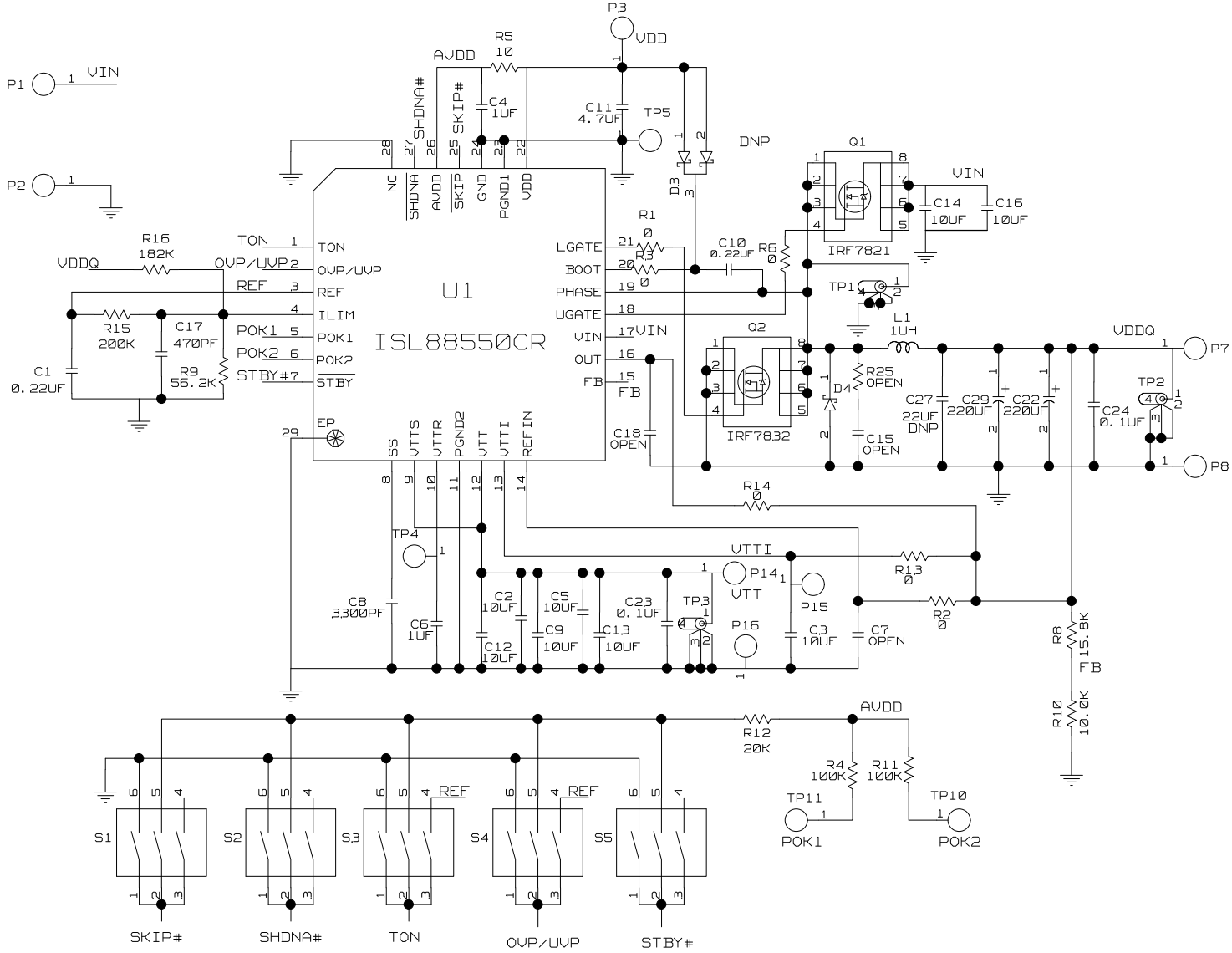

TABLE 6. COMPONENT LIST

REF DES	QTY	VALUE	TOL.	VOLTAGE	PACKAGE	PART NUMBER	MANUFACTURER	DESCRIPTION
C1, C10	2	0.22 μ F	10%	50V	SM0805	-	AVX, Samsung, TDK, Murata	Multilayer Capacitor
C2, C3, C9	3	10 μ F	10%	>6.3V	SMD0805	-	AVX, Samsung, TDK, Murata	Multilayer Capacitor
C14, C16	2	10 μ F	10%	25V	SMD1812	-	AVX, Samsung, TDK, Murata	X5R Capacitor
C4, C6	2	1 μ F	10%	10V	SM0805	-	AVX, Samsung, TDK, Murata	Multilayer Capacitor
C11	1	4.7 μ F	10%	10V	SM0805	-	AVX, Samsung, TDK, Murata	Multilayer Capacitor
C27	0	OPEN	20%	10V	SMD1210	-	AVX, Samsung, TDK, Murata	C Series Capacitor (EIA:CC1210)
C29, C29	2	220 μ F	20%	4.0V	EIA_CASE_D	EEFUE0G221R	Panasonic	AL POLYMER
C17	1	470pF	10%	50V	SM0805	-	AVX, Samsung, TDK, Murata	Multilayer Capacitor
C24	1	0.1 μ F	10%	50V	SM0805	-	AVX, Samsung, TDK, Murata	Multilayer Capacitor
C5, C7, C8, C12, C13, C15, C18, C23	0	Open	10%	50V	SM0805/ SM1206	-	AVX, Samsung, TDK, Murata	Multilayer Capacitor
D3	0	Open	-	30V	SOT23	BAT54WT1	On-Semi	30V Schottky Barrier Diode
D4	1	-	3A	40V	SMA	B340LA	Diodes-Inc	3A Low VF Schottky Barrier
L1	1	1.0 μ H	20%	2m Ω	13_5x13_5	SD10L1 HM65-H1R0 C6125-1R0 FDA1254-1R0M	Falco BI Sumida Toko	Shielded SMD Inductor
Q1	1	-	11A	30V	SOIC8	IRF7821V	IR	30V 8.3A N-Power MOSFET
Q2	1	-	16A	30V	SOIC8	IRF7811AV	IR	30V 10.8A N-Power MOSFET
R1, R2, R3, R6, R13, R14	8	0	1%	150V	0805	-	Generic	Thick Film Chip Resistor
R12	1	20k	1%	150V	0805	-	Generic	Thick Film Chip Resistor
R9	1	56.2k	1%	150V	0805	-	Generic	Thick Film Chip Resistor
R4, R11	2	100k	1%	150V	0805	-	Generic	Thick Film Chip Resistor
R16	1	182k	1%	150V	0805	-	Generic	Thick Film Chip Resistor
R15	1	200k	1%	150V	0805	-	Generic	Thick Film Chip Resistor
R5, R25	0	Open	1%	150V	0805/1206	-	Generic	Thick Film Chip Resistor
R8	1	15.8k	1%	150V	0805	-	Generic	Thick Film Chip Resistor
R10	1	10k		150V	0805	-	Generic	Thick Film Chip Resistor
SW1-SW5	5	-	-	-	DIP06	DIP06-SW03	Grayhill	Dip Switch SPST
U1	1	-	-	-	TQFN	ISL88550A	Intersil	High Efficiency Output Rectifier Controller

ISL88550AEVAL1Z Board Layout

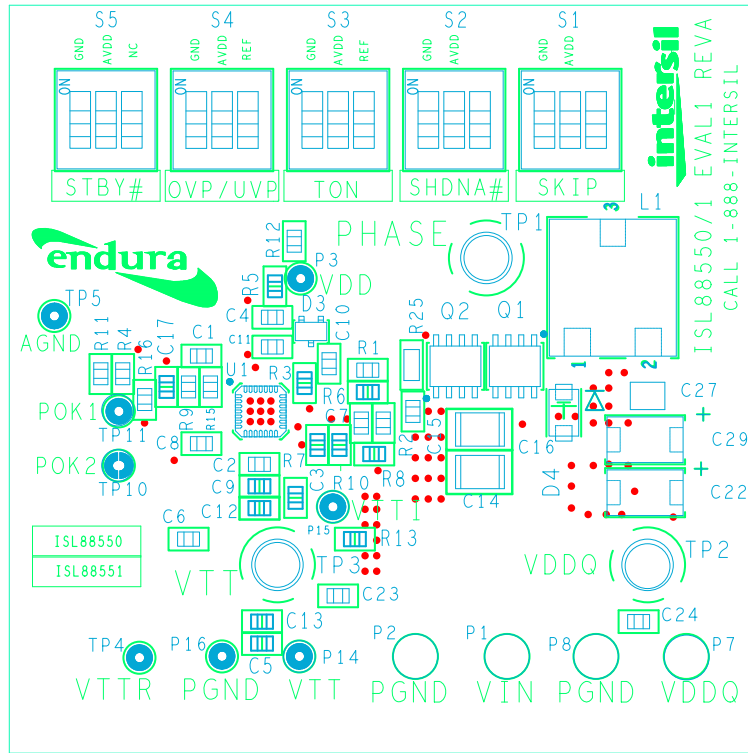

FIGURE 1. TOP COMPONENTS

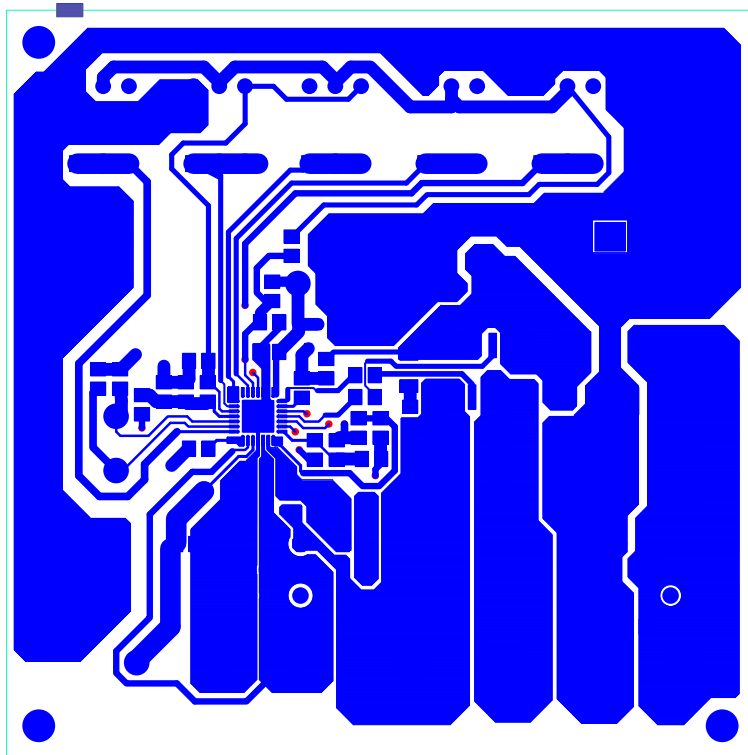

FIGURE 2. TOP LAYER ETCH

ISL88550AEVAL1Z Board Layout (Continued)

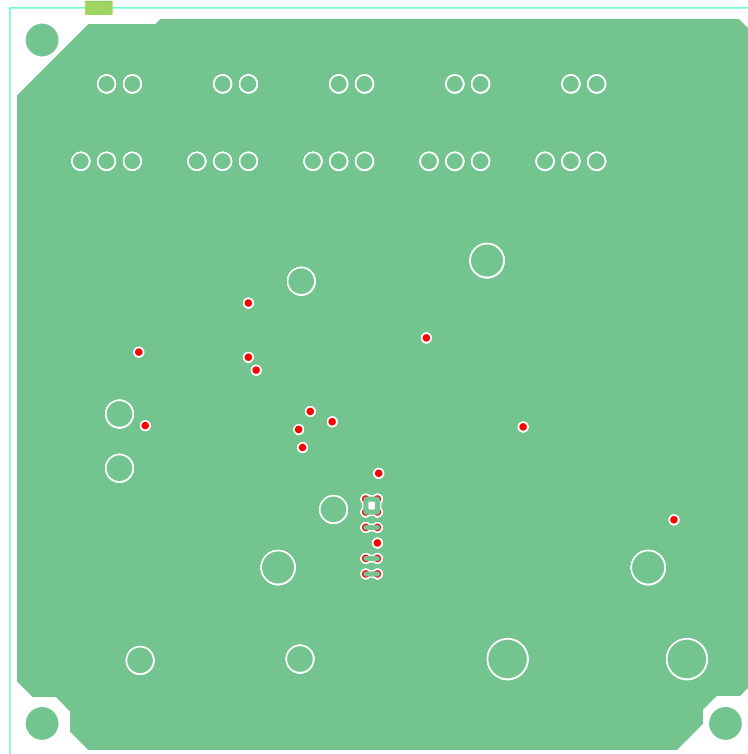

FIGURE 3. 2ND LAYER ETCH

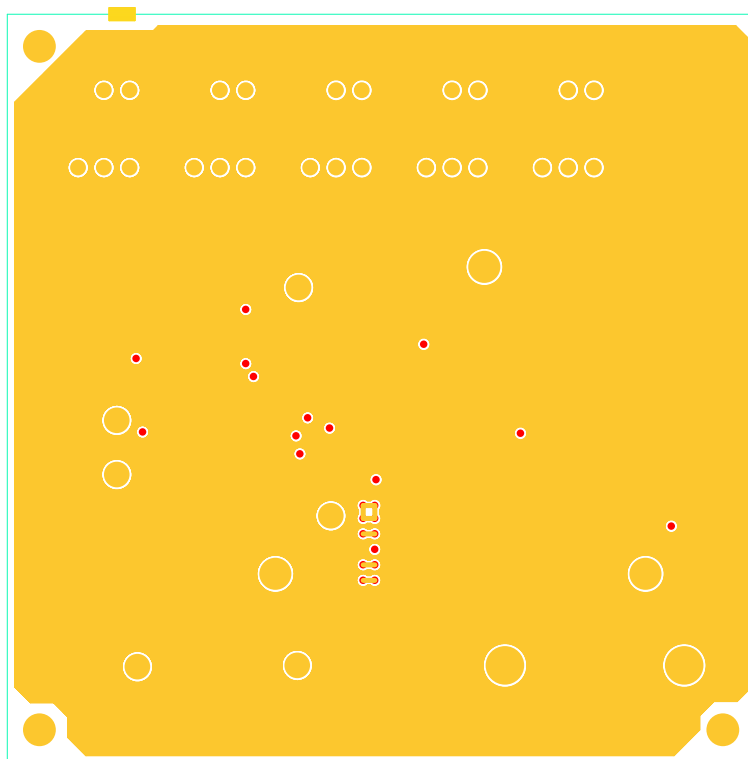

FIGURE 4. 3RD LAYER ETCH

ISL88550AEVAL1Z Board Layout (Continued)

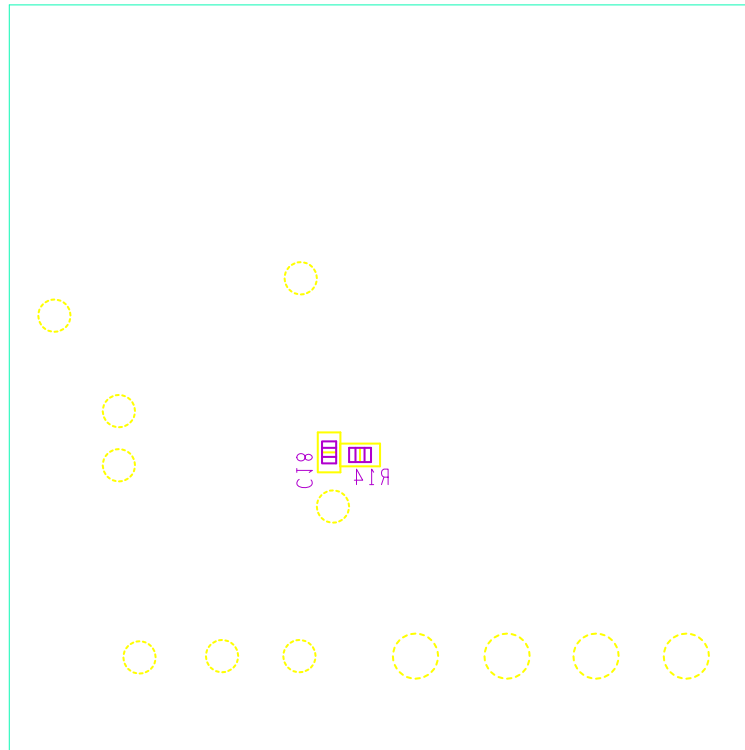

FIGURE 5. BOTTOM LAYER COMPONENTS (MIRRORED)

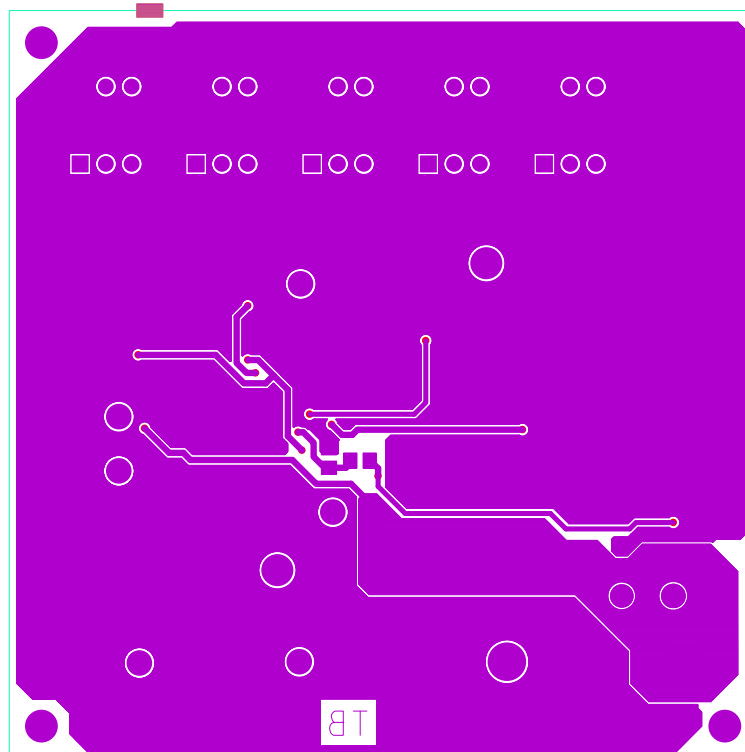

FIGURE 6. BOTTOM LAYER ETCH (MIRRORED)

Notice

1. Descriptions of circuits, software and other related information in this document are provided only to illustrate the operation of semiconductor products and application examples. You are fully responsible for the incorporation or any other use of the circuits, software, and information in the design of your product or system. Renesas Electronics disclaims any and all liability for any losses and damages incurred by you or third parties arising from the use of these circuits, software, or information.
2. Renesas Electronics hereby expressly disclaims any warranties against and liability for infringement or any other claims involving patents, copyrights, or other intellectual property rights of third parties, by or arising from the use of Renesas Electronics products or technical information described in this document, including but not limited to, the product data, drawings, charts, programs, algorithms, and application examples.
3. No license, express, implied or otherwise, is granted hereby under any patents, copyrights or other intellectual property rights of Renesas Electronics or others.
4. You shall not alter, modify, copy, or reverse engineer any Renesas Electronics product, whether in whole or in part. Renesas Electronics disclaims any and all liability for any losses or damages incurred by you or third parties arising from such alteration, modification, copying or reverse engineering.
5. Renesas Electronics products are classified according to the following two quality grades: "Standard" and "High Quality". The intended applications for each Renesas Electronics product depends on the product's quality grade, as indicated below.
"Standard": Computers; office equipment; communications equipment; test and measurement equipment; audio and visual equipment; home electronic appliances; machine tools; personal electronic equipment; industrial robots; etc.
"High Quality": Transportation equipment (automobiles, trains, ships, etc.); traffic control (traffic lights); large-scale communication equipment; key financial terminal systems; safety control equipment; etc.
Unless expressly designated as a high reliability product or a product for harsh environments in a Renesas Electronics data sheet or other Renesas Electronics document, Renesas Electronics products are not intended or authorized for use in products or systems that may pose a direct threat to human life or bodily injury (artificial life support devices or systems; surgical implantations; etc.), or may cause serious property damage (space system; undersea repeaters; nuclear power control systems; aircraft control systems; key plant systems; military equipment; etc.). Renesas Electronics disclaims any and all liability for any damages or losses incurred by you or any third parties arising from the use of any Renesas Electronics product that is inconsistent with any Renesas Electronics data sheet, user's manual or other Renesas Electronics document.
6. When using Renesas Electronics products, refer to the latest product information (data sheets, user's manuals, application notes, "General Notes for Handling and Using Semiconductor Devices" in the reliability handbook, etc.), and ensure that usage conditions are within the ranges specified by Renesas Electronics with respect to maximum ratings, operating power supply voltage range, heat dissipation characteristics, installation, etc. Renesas Electronics disclaims any and all liability for any malfunctions, failure or accident arising out of the use of Renesas Electronics products outside of such specified ranges.
7. Although Renesas Electronics endeavors to improve the quality and reliability of Renesas Electronics products, semiconductor products have specific characteristics, such as the occurrence of failure at a certain rate and malfunctions under certain use conditions. Unless designated as a high reliability product or a product for harsh environments in a Renesas Electronics data sheet or other Renesas Electronics document, Renesas Electronics products are not subject to radiation resistance design. You are responsible for implementing safety measures to guard against the possibility of bodily injury, injury or damage caused by fire, and/or danger to the public in the event of a failure or malfunction of Renesas Electronics products, such as safety design for hardware and software, including but not limited to redundancy, fire control and malfunction prevention, appropriate treatment for aging degradation or any other appropriate measures. Because the evaluation of microcomputer software alone is very difficult and impractical, you are responsible for evaluating the safety of the final products or systems manufactured by you.
8. Please contact a Renesas Electronics sales office for details as to environmental matters such as the environmental compatibility of each Renesas Electronics product. You are responsible for carefully and sufficiently investigating applicable laws and regulations that regulate the inclusion or use of controlled substances, including without limitation, the EU RoHS Directive, and using Renesas Electronics products in compliance with all these applicable laws and regulations. Renesas Electronics disclaims any and all liability for damages or losses occurring as a result of your noncompliance with applicable laws and regulations.
9. Renesas Electronics products and technologies shall not be used for or incorporated into any products or systems whose manufacture, use, or sale is prohibited under any applicable domestic or foreign laws or regulations. You shall comply with any applicable export control laws and regulations promulgated and administered by the governments of any countries asserting jurisdiction over the parties or transactions.
10. It is the responsibility of the buyer or distributor of Renesas Electronics products, or any other party who distributes, disposes of, or otherwise sells or transfers the product to a third party, to notify such third party in advance of the contents and conditions set forth in this document.
11. This document shall not be reprinted, reproduced or duplicated in any form, in whole or in part, without prior written consent of Renesas Electronics.
12. Please contact a Renesas Electronics sales office if you have any questions regarding the information contained in this document or Renesas Electronics products.
(Note 1) "Renesas Electronics" as used in this document means Renesas Electronics Corporation and also includes its directly or indirectly controlled subsidiaries.
(Note 2) "Renesas Electronics product(s)" means any product developed or manufactured by or for Renesas Electronics.

(Rev.4.0-1 November 2017)



SALES OFFICES

Renesas Electronics Corporation

<http://www.renesas.com>

Refer to "<http://www.renesas.com/>" for the latest and detailed information.

Renesas Electronics America Inc.
1001 Murphy Ranch Road, Milpitas, CA 95035, U.S.A.
Tel: +1-408-432-8888, Fax: +1-408-434-5351

Renesas Electronics Canada Limited
9251 Yonge Street, Suite 8309 Richmond Hill, Ontario Canada L4C 9T3
Tel: +1-905-237-2004

Renesas Electronics Europe Limited
Dukes Meadow, Millboard Road, Bourne End, Buckinghamshire, SL8 5FH, U.K
Tel: +44-1628-651-700, Fax: +44-1628-651-804

Renesas Electronics Europe GmbH
Arcadiastrasse 10, 40472 Düsseldorf, Germany
Tel: +49-211-6503-0, Fax: +49-211-6503-1327

Renesas Electronics (China) Co., Ltd.
Room 1709 Quantum Plaza, No.27 ZhichunLu, Haidian District, Beijing, 100191 P. R. China
Tel: +86-10-8235-1155, Fax: +86-10-8235-7679

Renesas Electronics (Shanghai) Co., Ltd.
Unit 301, Tower A, Central Towers, 555 Langao Road, Putuo District, Shanghai, 200333 P. R. China
Tel: +86-21-2226-0888, Fax: +86-21-2226-0999

Renesas Electronics Hong Kong Limited
Unit 1601-1611, 16/F., Tower 2, Grand Century Place, 193 Prince Edward Road West, Mongkok, Kowloon, Hong Kong
Tel: +852-2265-6688, Fax: +852-2886-9022

Renesas Electronics Taiwan Co., Ltd.
13F, No. 363, Fu Shing North Road, Taipei 10543, Taiwan
Tel: +886-2-8175-9600, Fax: +886-2-8175-9670

Renesas Electronics Singapore Pte. Ltd.
80 Bendemeer Road, Unit #06-02 Hyflux Innovation Centre, Singapore 339949
Tel: +65-6213-0200, Fax: +65-6213-0300

Renesas Electronics Malaysia Sdn.Bhd.
Unit 1207, Block B, Menara Amcorp, Amcorp Trade Centre, No. 18, Jln Persiaran Barat, 46050 Petaling Jaya, Selangor Darul Ehsan, Malaysia
Tel: +60-3-7955-9390, Fax: +60-3-7955-9510

Renesas Electronics India Pvt. Ltd.
No.777C, 100 Feet Road, HAL 2nd Stage, Indiranagar, Bangalore 560 038, India
Tel: +91-80-67208700, Fax: +91-80-67208777

Renesas Electronics Korea Co., Ltd.
17F, KAMCO Yangjae Tower, 262, Gangnam-daero, Gangnam-gu, Seoul, 06265 Korea
Tel: +82-2-558-3737, Fax: +82-2-558-5338