

# ISL97649A, ISL97649B Evaluation Board Manual

## Description

The ISL97649AIREVALZ and ISL97649BIREVALZ are evaluation boards for the ISL97649A and ISL97649B, respectively. The ISL97649A, ISL97649B are DC/DC voltage regulators for TFT-LCD displays, with screen sizes up to 20". The devices integrate a boost converter, logic LDO (for ISL97649A only),  $V_{ON}$  slice circuit, supply monitor circuit, and a high performance  $V_{COM}$  amplifier with DCP (Digital Controlled Potentiometer). Some key features and capabilities of the ISL97649A, ISL97649B devices and evaluation boards are:

1. Deliver up to 450mA current for the TFT-LCD AVDD supply used by various ICs including the source/column driver ICs.
2. Use an LDO to generate a low voltage needed by external digital circuitry (ISL97649A only).
3. Generate  $V_{ON}$  (gate high) and  $V_{OFF}$  (gate low) voltages used by the TFT-LCD panel row/gate driver ICs.
4. Generate a modulated VGH\_M output for the gate high voltage, with desired delay time and discharge slope controlled by the  $V_{ON}$  slice circuit.
5.  $V_{COM}$  voltage calibration for setting the TFT-LCD pixel common bias voltage. The DCP uses an I<sup>2</sup>C interface and has EEPROM to store the final value. An integrated high performance amplifier drives the calibrated TFT-LCD  $V_{COM}$  voltage.
6. Assert/de-assert a RESET signal at power-ON/OFF

The ISL97649AIREVALZ and ISL97649BIREVALZ evaluation board provide jumpers that allow users to select either 600kHz or 1.2MHz switching frequency, and to enable or disable the IC.

## Related Documents

[ISL97649A](#), [ISL97649B](#) datasheet

## Ordering Information

PART #	DESCRIPTION
ISL97649AIREVALZ	Evaluation Board for ISL97649A
ISL97649BIREVALZ	Evaluation Board for ISL97649B

## What is Needed

The following instruments will be needed to perform testing:

- Power supplies
- DC Electronic load (E-Load)
- Multimeters
- Oscilloscope
- Resistors
- Cables and wires

## Quick Setup Guide

- Step 1: Connect the power supply between headers of VIN and PGND. The positive output of the power supply should be connected to VIN header. Set the power supply voltage between 2.5V and 5.5V, and current limit at 4A.
- Step 2: Connect the positive and negative inputs of the electronic load to AVDD header and AVDD\_GND, respectively. The load current should not exceed the maximum output current in Table 1.
- Step 3: Connect JP5 to tie FREQ pin to VIN to set 1.2MHz switching frequency. Disconnect JP5, FREQ is internally pulled to ground to set 600kHz.
- Step 4: Connect pin 2 of JP6 to pin 1 to tie EN pin to VIN (default setting) or VLOGIC to enable the part. Connect pin 2 of JP6 to pin 3 to pull EN pin to ground through R21 to disable the IC.
- Step 5: Connect pin 2 of JP7 to pin 1 to tie VIN pin of IC to board VIN, or connect pin 2 of JP7 to pin 3 to tie VIN pin of IC to LDO\_VIN.
- Step 6: Connect JP4 to connect LDO\_VIN to VIN, or connect headers of LDO\_VIN to a separate power supply. Set the power supply voltage between 2.5V and 5.5V.
- Step 7: Connect JP2 to use AVDD boost output as the external charge pump input.
- Step 8: Connect an electronic load between headers of  $V_{ON}$  and  $V_{IN\_GND}$ . The positive input of the electronic load should be connected to  $V_{ON}$  header, the negative input of the electronic load should be connected to  $V_{IN\_GND}$ . Connect the electronic load between headers of  $V_{OFF}$  and  $V_{IN\_GND}$ . The positive input of the electronic load should be connected to  $V_{IN\_GND}$  header, the negative input of the electronic load should be connected to  $V_{OFF}$ . Set the load current values in the electronic load. The values of  $V_{ON}$  and  $V_{OFF}$  at different loadings are shown in Table 2.
- Step 9: Connect pin 2 of JP3 to pin 1 to connect VDIV to a resistive divider between VIN and GND, or connect pin 2 to pin 3 to connect VDIV to a resistive divider between VLOGIC and GND.
- Step 10: Connect JP1 to connect  $V_{ON}$  to VGH.
- Step 11: Connect input from signal generator between headers of VFLK and SGND. Select square waveform with an amplitude of 3.3V and frequency of 50kHz.
- Step 12: Connect ISLUSBCEVAL1Z to the ISL97649 Evaluation Board at U2 location. Then, connect USB cable between Personal Computer's USB port and ISLUSBCEVAL1Z for USB to I<sup>2</sup>C communication.
- Step 13: Make sure all connections to the Evaluation Board are correct, then turn on the power supply followed by the electronic load. The part will power-ON and start operating.

## AVDD Maximum Output Current

The internal MOSFET typical peak current limit is 1.5A (Note 1). This limits the maximum AVDD continuous output current that the ISL97649A/B Boost Converter can deliver to the load. Maximum AVDD continuous output current in an actual application may vary depending on component variations. Feedback compensation parameters, input and output capacitance of the boost converter may need to be modified in order to achieve the stability with maximum peak inductor current of 1.5A. Table 1 shows the maximum AVDD continuous output current  $I_{OMAX}$  at different  $V_{IN}$  and AVDD voltages.

**TABLE 1. TYPICAL MAXIMUM OUTPUT CURRENT**

$V_{IN}$ (V)	AVDD (V)	$I_{OMAX}$ (mA) (Note 1)
3.3	8	450
3.3	12	310
5.0	8	730
5.0	12	460

**NOTES:**

1. Typical peak current and maximum continuous output current values are based on 1.2MHz boost switching frequency and 10µH inductor.

## $V_{ON}$ and $V_{OFF}$ at Different Loading Conditions

The ISL97649AIREVALZ and ISL97649BIREVALZ evaluation board generates  $V_{ON}$  and  $V_{OFF}$  voltages using unregulated charge pumps. The  $V_{ON}$  and  $V_{OFF}$  voltages generated are based on the AVDD output. Table 2 shows different values of  $V_{ON}$  and  $V_{OFF}$  with different AVDD voltages, loading conditions, and charge pump (CP) configurations for 1.2MHz switching frequency.

**TABLE 2. TYPICAL  $V_{ON}$  AND  $V_{OFF}$  FOR DIFFERENT LOADING**

$I_{LOADING}$ (mA)	$V_{ON}$ (V)			$V_{OFF}$ (V)	
	AVDD = 8V SINGLE STAGE CP	AVDD = 8V DUAL STAGE CP	AVDD = 12V SINGLE STAGE CP	AVDD = 8V	AVDD = 12V
1	15.2	23.4	23.8	4.3	4.4
5	15.1	23.2	23.3	4.3	4.3
10	14.7	23.0	23.2	4.2	4.3

## ISL97649A/B Evaluation Software

The next section explains how to install the graphical user interface (GUI) software, which is used to configure the ISL97649A/B register and EEPROM.

### Computer Requirements

- WinXP or newer with 512MB of RAM
- 10MB of free hard disk space
- An unused USB port
- Administrator privileges

### Notes

The GUI software was developed on a 32-bit Windows XP platform. Because the GUI software registers as a Human Interface Device (HID) and uses standard HID calls, it should also work on other XP or later Windows operating systems (32-bit and 64-bit), including Windows 7.

This application note contains screenshots of the GUI at the time this user guide was written. Subsequent GUI versions may appear differently.

### Software Installation

The following steps explain how to install the ISL97649AIREVALZ, and ISL97649BIREVALZ software to a PC. The ISL97649A and ISL97649B software installation steps are the same (the following examples show ISL97649A) and will install the drivers and user interface.

- Step 1: Download the installer file to the PC. The installer file is named "ISL97649A\_Installer\_vX.Y", where "X.Y" is the version number (e.g., v1.2). The installer file may be provided from Intersil on a CD with the evaluation kit, or as an email attachment.
- Step 2: Run the installer file
- Step 3: Follow the installation wizard to install the evaluation software to the PC

# Application Note 1646

When the installer file is run, the window in Figure 1 will appear.

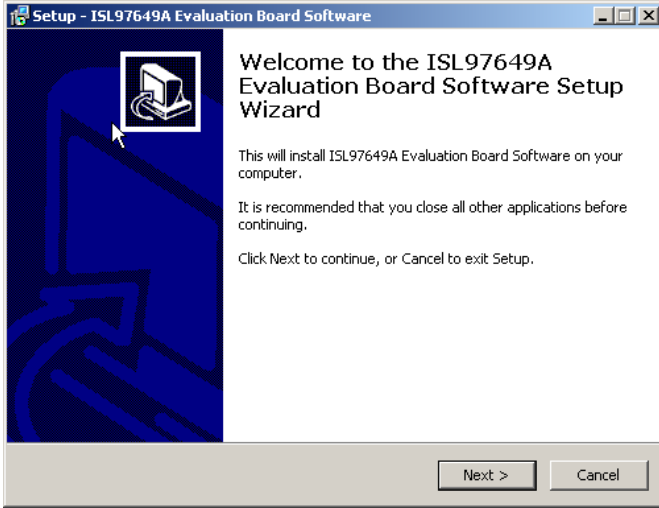

FIGURE 1. INSTALLER WINDOW

Choose **Next** to proceed to the License Agreement (Figure 2).

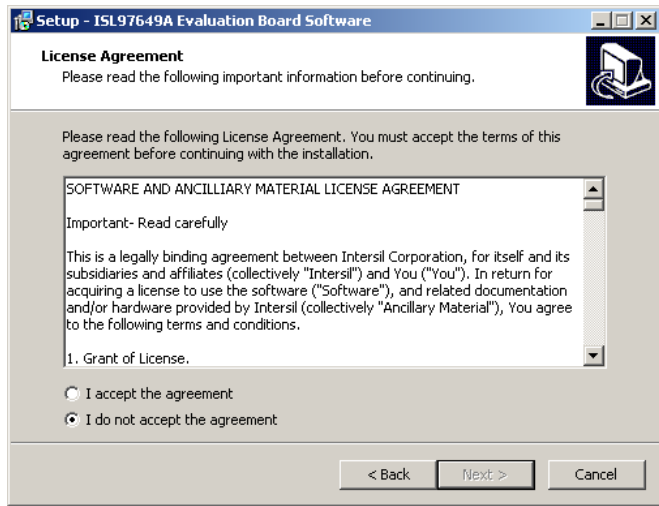

FIGURE 2. LICENSE AGREEMENT

Read the License Agreement, and accept or not accept. To move on with installation, the user has to accept to the License Agreement, and click **Next** to proceed to **Select Destination Location** (Figure 3).

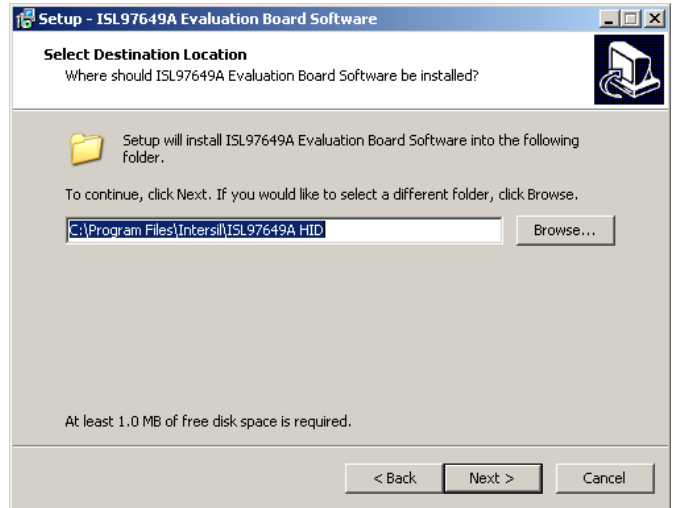

FIGURE 3. SELECT DESTINATION LOCATION

The default directory is **C:\Program Files\Intersil\ISL97649A HID**. To specify a directory different from the default location, click the **Browse** button. Click **Next** to continue to the **Select Start Menu Folder** (Figure 4).

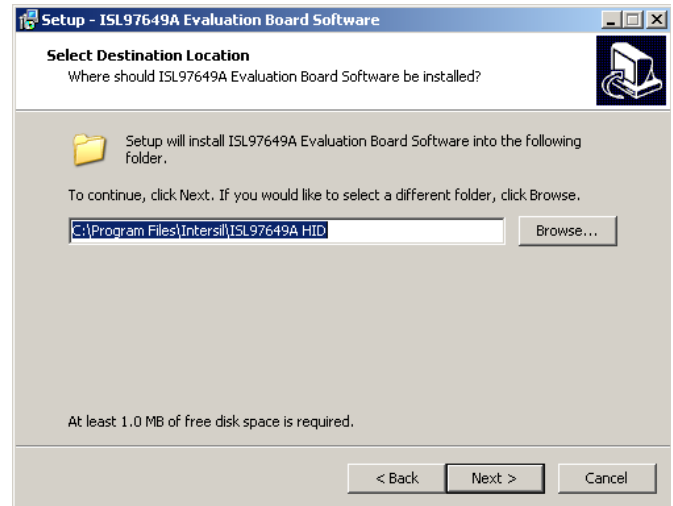

FIGURE 4. SELECT START MENU FOLDER

# Application Note 1646

To specify a folder different from the default, click the **Browse** button. Click **Next** to create the Intersil folder in the **Start** menu and proceed to the **Ready to Install** window (Figure 5).

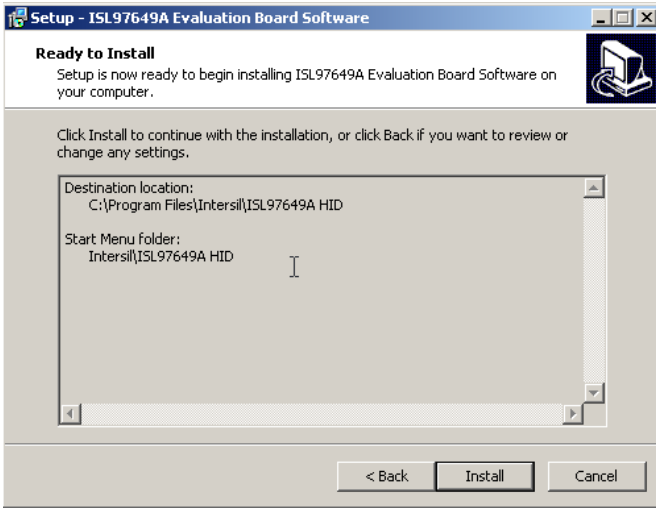

FIGURE 5. READY TO INSTALL

Click **Install** to complete the installation. When **Install** is clicked, the following **Setup** dialog box (Figure 6) will prompt the user to either select to install or not install some required ActiveX controls required by the GUI. Depending on the Windows operating system and controls already installed, these may or may not be required. Click **Yes** to install the controls during the software installation, or **No** to only install the software. These controls can always be installed later by re-running the installer.

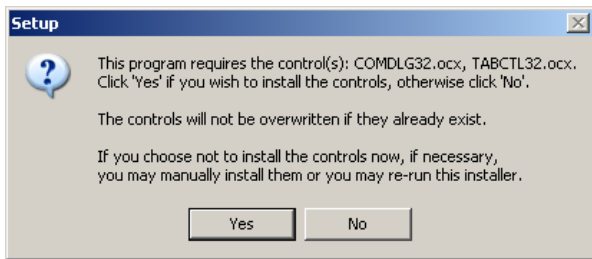

FIGURE 6. SETUP

## HID USB Module

The ISL97649AIREVALZ, ISL97649BIREVALZ board will be shipped with an Intersil HID USB Module - ISLUSBCEVAL1Z REV.A (Figure 7).

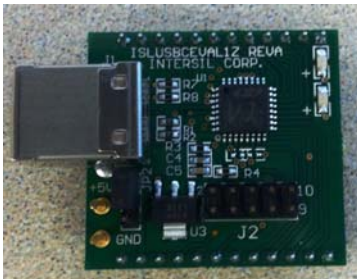

FIGURE 7. HID USB MODULE

## USB Module Installation

When the ISLUSBCEVAL1Z-REV.A USB module is initially connected to the PC, Windows XP may display the **Found New Hardware** pop-up messages (Figure 8).

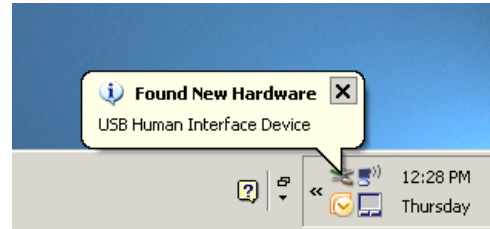
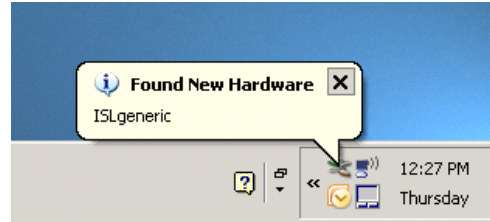

FIGURE 8. FOUND NEW HARDWARE

The messages mean the USB module has been identified and is registering itself as a HID on your computer. The process should complete within a few seconds.

On XP systems, the following pop-up message may appear, displaying the status of the USB module hardware (Figure 9).

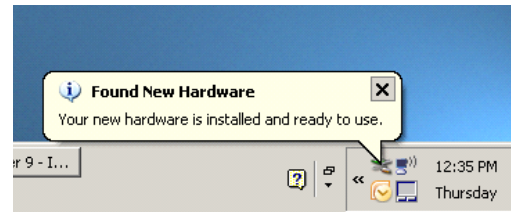

FIGURE 9. HARDWARE INSTALLED NOTIFICATION

If a **Found New Hardware** window appears asking for the location of device drivers, please contact Intersil for a new USB module.

# Application Note 1646

## Using the Software

### OPEN/RUN THE SOFTWARE

Once the software is installed on the PC, go to the location where the Start Menu folder was installed (default location is: Start Menu\Programs\Intersil\ISL97649A HID) and launch the program.

Prior to loading/opening the main Graphical User Interface (“GUI”) form, the software will check that an Intersil HID USB module is connected to the PC. If the module is not connected a dialog box will pop-up (Figure 10) to indicate that the board is not found.

Check that the USB cable and an Intersil HID USB module are properly connected. Choose **Retry** to try again. If the connection is good, the GUI form will be opened (Figure 11). However, the GUI can be opened without the USB module attached. To do this, choose **Cancel** in the dialog box.

Once the GUI form opens, the HID Module Status button (labeled “CONNECT”) will be GREEN in color if the HID USB module is connected, or RED if it is not connected. Note, if a new module is connected, or a module is unplugged and then reconnected after launching the software, the button color will *not* change dynamically. The software does not continuously poll to check for the USB module connection. If connection is lost, to re-establish, click the **CONNECT** button.

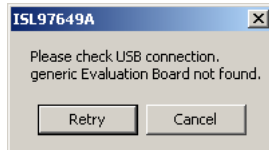
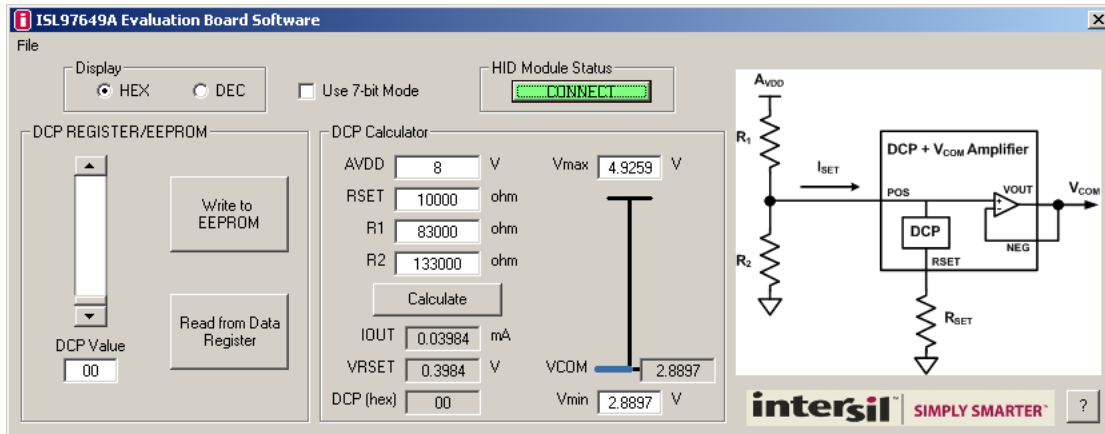
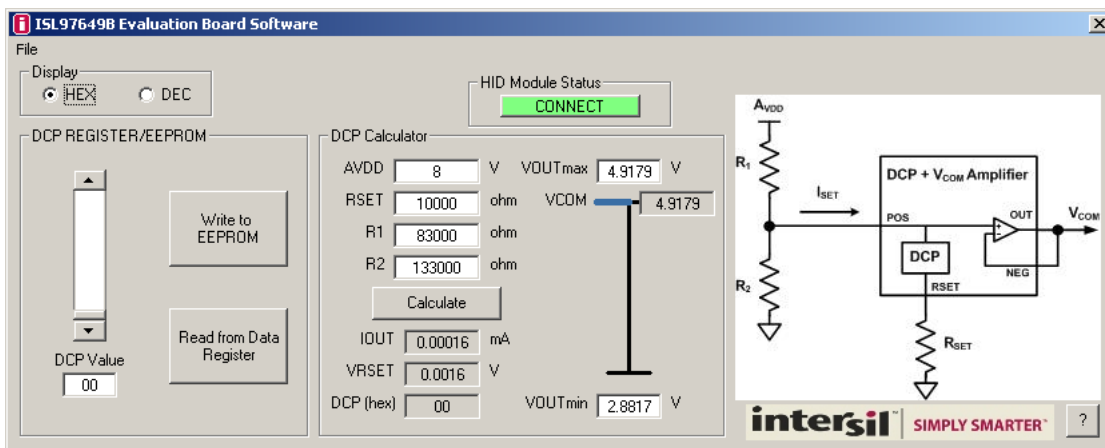

FIGURE 10. USB CONNECTION



ISL97649A GUI



ISL97649B GUI

FIGURE 11. ISL97649A, ISL97649B GUI WINDOWS

# Application Note 1646

## SOFTWARE FEATURES AND BUTTONS

The ISL97649A/B software has various features and options making it flexible and easy to use for evaluation of the ISL97649. The following is a list of the software interface features, buttons, and options and how to use them effectively.

The software allows selection between the 8-bit register and 7-bit register. The controls of the GUI operate as follows (refer to Figure 11 to identify the controls).

**Display Mode:** Choose the Display Mode for the register value/data by clicking on the radio button. HEX = hexadecimal, DEC = decimal.

**7/8-bit Mode (ISL97649A only):** Choose if DCP/calibration operation is 127 step (7-bit) or 256 step (8-bit) resolution.

**DCP Register Slider:** Adjusting this slider will automatically send an I<sup>2</sup>C transaction to change the WR register value only (not EEPROM) - when the value is changed, the "Write to EEPROM" button will begin to flash indicating that the new register value differs from the EEPROM.

To directly move the vertical slider position:

- Click on the Up/Down arrows of the vertical slider bar to increment the count by 1. The new code is reflected in the DCP Value text box.
- Click-hold on the vertical slider bar and drag it to a new position. The new code is reflected in the DCP Value text box.
- Click anywhere on the vertical slider bar. Clicking above the current bar level will increment the value by 16dec (0x10). Clicking below the current bar level will decrement the value by 16dec (0x10).

To directly change the DCP text box value (i.e., DCP register code) click in the text box to put focus in the box. Then, either highlight the digit to be changed, or highlight and change all digits. The software pauses briefly between each keyboard key stroke to make sure nothing more will be entered, then it accepts the value to the software. The new code is reflected on the vertical slider position. Press "Enter" on the PC keyboard to send the I<sup>2</sup>C transaction.

Also, once focus has been put on the slider or text entry box (by clicking), there are keyboard commands that quickly make deterministic adjustments to the value:

- **Page Up** key: increments the DCP value by 16dec (0x10)
- **Page Down** key: decrements the DCP value 16dec (0x10)
- **Up Arrow** key: increments the DCP value by 1
- **Down Arrow** key: decrements the DCP value by 1

**Write to EEPROM:** Click on this button will write the existing DCP register value into IVR (i.e., EEPROM).

**Read from Data Register:** Click on this button, a dialog box will pop-up to prompt selection of reading from WR or reading from IVR.

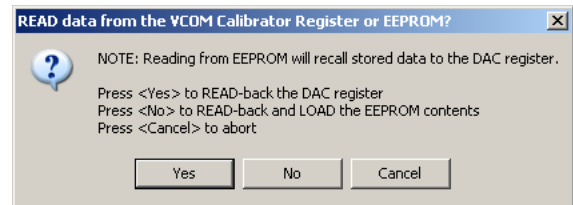

FIGURE 12. INDICATE TYPE OF READ OPERATION

Click "Yes" to read directly from WR register value only; click "No" to load IVR (EEPROM) to the WR then read the value; click "Cancel" to abort.

**HID Module Status:** Click this button to check the USB connection. If the connection is good, the button turns GREEN, if not it will turn RED.

**DCP Calculator:** The calculator tool allows finding the expected calibration range and POS voltage based on known resistor values, or finding resistor values based on a desired calibration range. The calculator determines a theoretical voltage at the POS pin, actual VCOM output may vary slightly due to amplifier offset.

**Help:** Clicking "?" will open a dialog box with additional information about how to use the IC and GUI.

## Evaluation Board Design Schematic

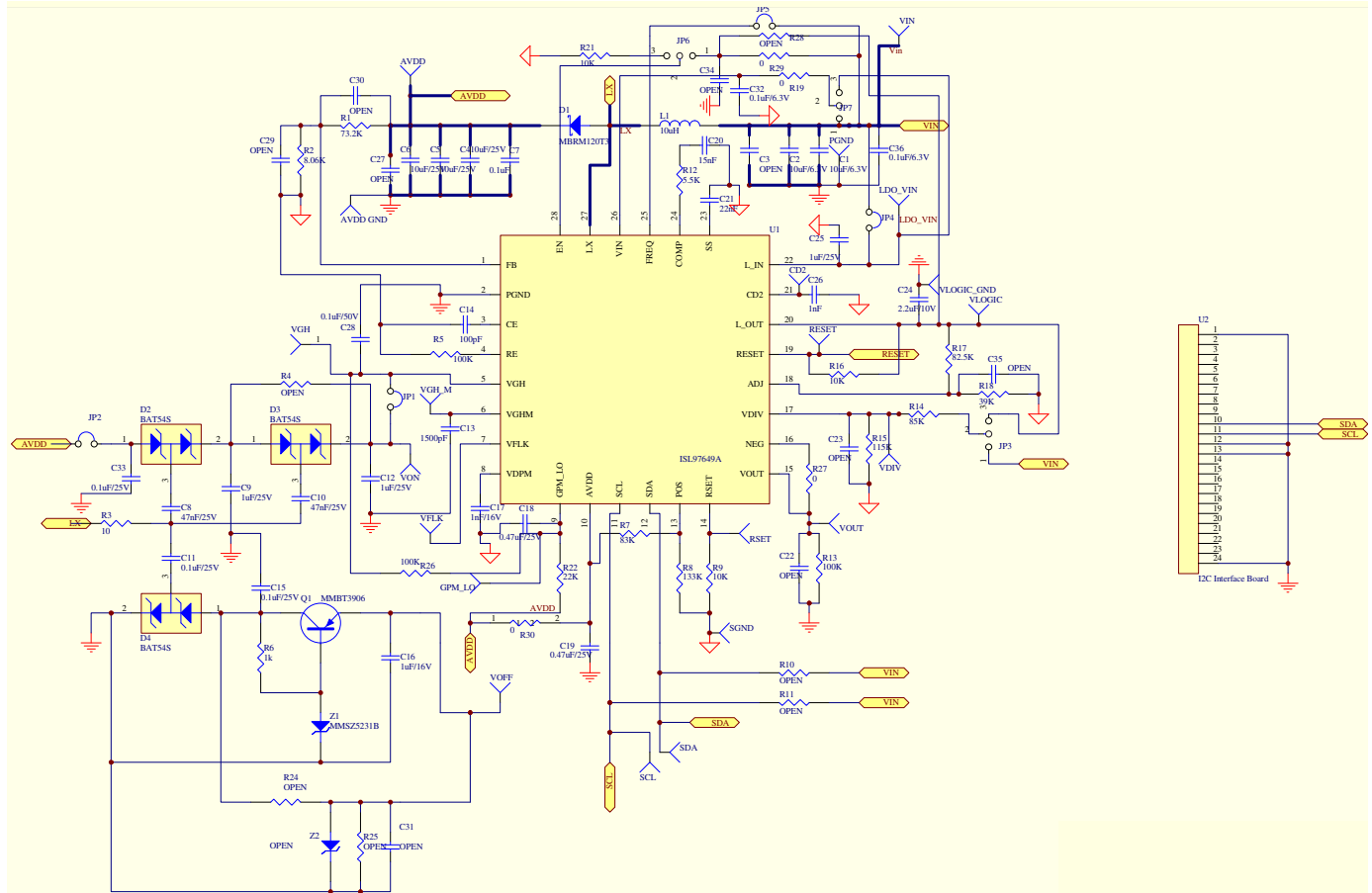

## Layout Recommendation

The device performance (including efficiency, output noise, transient response and control loop stability) is dramatically affected by the PCB layout. PCB layout is critical, especially at higher switching frequency.

Here are some general guidelines for layout:

1. Place the external power components (input capacitors, output capacitors, boost inductor and output diodes, etc.) in close proximity to the device. Traces to these components should be kept as short and wide as possible to minimize parasitic inductance and resistance.
2. Place VIN bypass capacitors close to the pins.
3. Shorten the trace length from the LX pin to the FB pin. Place the L1 inductor and D1 diode as close as possible to the LX pin in order to minimize the voltage noise and current loop on large AC amplitude and fast slew rate signal at the LX node.
4. The feedback network should sense the output voltage directly from the point of load, and should be placed close to the IC but as far away from the LX node as possible.
5. The power ground (PGND) plane and signal ground (SGND) plane should be connected at only one point on the PCB near the device.
6. The exposed die plate should be soldered to an equivalent area of metal on the PCB. This contact area should have multiple via connections to the back of the PCB as well as connections to intermediate PCB layers, if available, to maximize thermal dissipation away from the IC.
7. To minimize the thermal resistance of the package when soldered to a multi-layer PCB, the amount of copper track and ground plane area connected to the exposed die plate should be maximized and spread out as far as possible from the IC. Especially, the top and bottom areas of the PCB should be maximized to allow thermal dissipation to the surrounding air.
8. Minimize feedback input track lengths to avoid switching noise pick-up.

The ISL97649AIREVALZ, ISL97649BIREVALZ layout beginning on page 8, is provided to illustrate the proper layout implementation.





**ISL97649AIREVALZ, ISL97649BIREVALZ Layout** (Continued)

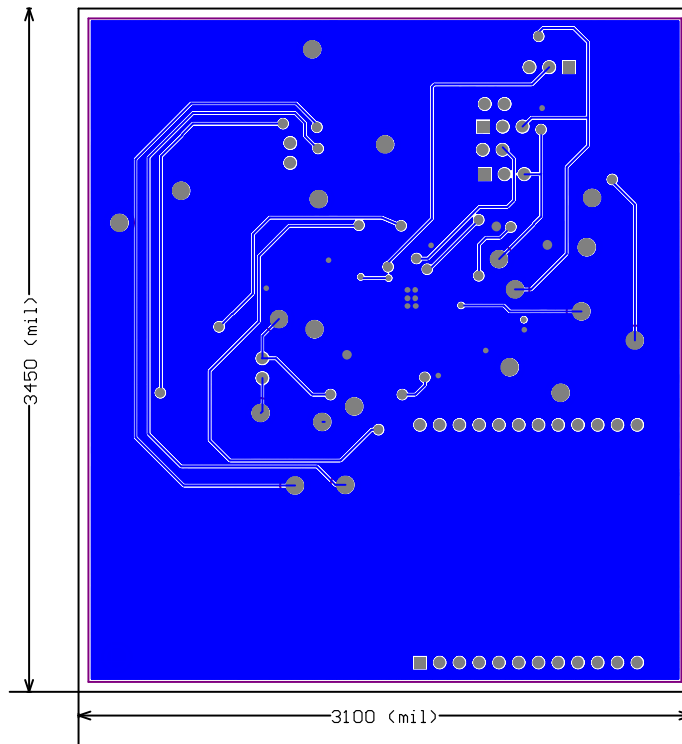

**FIGURE 15. BOTTOM LAYER**

# Application Note 1646

TABLE 3. BOM FOR ISL97649AIREVALZ, ISL97649BIREVALZ EVALUATION BOARD

PART TYPE	DESIGNATOR	FOOTPRINT
73.2k	R1	0603
8.06k	R2	0603
10	R3	0603
OPEN	R4, R24, R25, R28	0603
100k	R5, R10, R11, R13, R26	0603
1k	R6	0603
83k	R7	0603
133k	R8	0603
10k	R9, R16, R21	0603
5.5k	R12	0603
85k	R14	0603
115k	R15	0603
82.5k	R17	0603
39k	R18	0805
0	R19, R27, R29, R30	0603
22k	R22	0603
10 $\mu$ F/6.3V	C1, C2	0805
OPEN	C3	0805
10 $\mu$ F/25V	C4, C5, C6	1210
0.1 $\mu$ F	C7	0603
47nF/25V	C8	0603
1 $\mu$ F/25V	C9, C12	0603
47nF/25V	C10	0603
0.1 $\mu$ F/25V	C11, C15	0603
1500pF	C13	1206
100pF	C14	0603
1 $\mu$ F/16V	C16, C17	0603
0.47 $\mu$ F/25V	C18	0603
0.47 $\mu$ F/25V	C19	0805
15nF	C20	0603
22nF	C21	0603
OPEN	C22, C23, C27, C29, C30, C31, C34, C35	0603
2.2 $\mu$ F/10V	C24	0603
1 $\mu$ F/25V	C25	0603
1nF	C26	0603
0.1 $\mu$ F/50V	C28	1210
0.1 $\mu$ F/6.3V	C32, C36	0603
0.1 $\mu$ F/25V	C33	0603
MBRM120T3	D1	Case475
BAT54S	D2	SOT-23

# Application Note 1646

TABLE 3. BOM FOR ISL97649AIREVALZ, ISL97649BIREVALZ EVALUATION BOARD (Continued)

PART TYPE	DESIGNATOR	FOOTPRINT
BAT54S	D3	SOT-23
BAT54S	D4	SOT-23
JUMPER	JP1, JP2, JP4, JP5	JUMPER-2PIN
JUMPER	JP3, JP6, JP7	JUMPER-3PIN
10 $\mu$ H	L1	RLF7030
MMBT3906	Q1	SOT-23
ISL97649	U1	QFN28 4X5MM
MMSZ 5233B	Z1	SOD-123
OPEN	Z2	SOD-123
AVDD	AVDD	POWERPOST
AVDD_GND	AVDD_GND	POWERPOST
CD2	CD2	POWERPOST
GPM_LO	GPM_LO	POWERPOST
LDO_VIN	LDO_VIN	POWERPOST
PGND	PGND	POWERPOST
RESET	RESET	POWERPOST
RSET	RSET	POWERPOST
SCL	SCL	POWERPOST
SDA	SDA	POWERPOST
SGND	SGND	POWERPOST
VDIV	VDIV	POWERPOST
VFLK	VFLK	POWERPOST
VGH	VGH	POWERPOST
VGH_M	VGH_M	POWERPOST
VIN	VIN	POWERPOST
VLOGIC	VLOGIC	POWERPOST
VLOGIC_GND	VLOGIC_GND	POWERPOST
VOFF	VOFF	POWERPOST
VON	VON	POWERPOST
VOUT	VOUT	POWERPOST

Intersil Corporation reserves the right to make changes in circuit design, software and/or specifications at any time without notice. Accordingly, the reader is cautioned to verify that the Application Note or Technical Brief is current before proceeding.

For information regarding Intersil Corporation and its products, see [www.intersil.com](http://www.intersil.com)