

RTKA12120DE0000BU

The [RRM12120](#) is a 20A synchronous step-down DC/DC converter power module with integrated digital PWM controller, smart power stage (SPS), power inductor, and passive components. The RTKA12120DE0000BU evaluation board (shown in [Figure 6](#)) features the RRM12120. Capable of delivering up to 20A of continuous current, the RRM12120 is a single-channel, step-down power supply that is optimized for high power density applications without the need for airflow or heatsink.

The RTKA12120DE0000BU evaluation board is a 3.8in x 3.5in 6-layer FR4 board with 2oz. copper on all layers. Operating from a single 4.75V to 15V input power rail, the RTKA12120DE0000BU evaluation board offers adjustable output voltages down to 0.6V and efficiencies of up to 94%. The RRM12120 uses the proprietary Renesas digital synthetic current modulation scheme to achieve the industry-best combination of transient response, ease of tuning, and efficiency across the full load range. The RTKA12120DE0000BU evaluation board is designed to program switching frequencies up to 1.25MHz. The Renesas [PowerNavigator™](#) can be used to configure and monitor the device. Soft-start/soft-stop time, TON/TOFF delay, VOUT transition rate can be easily configured using the PowerNavigator tool. VIN UVLO and its hysteresis amongst the various parameters, can be configured in the PowerNavigator without the need for hardware modification.

Features

- Input voltage range from 4.75V to 15V
- Adjustable output voltage from 0.6V to 3.3V
- $\pm 0.7\%$ accuracy over line, load, and temperature
- Up to 94% conversion efficiency
- Programmable soft-start/soft-stop, TON/TOFF delay, VOUT transition rate
- Pre-bias output start-up
- Dedicated enable pin and PGOOD indicator
- UVLO, programmable overcurrent, overvoltage, and over-temperature
- Thermally enhanced 10mm×13mm×5.9mm BGA-PoP package

Specifications

The evaluation board is configured and optimized for the following operating conditions:

- $V_{IN} = 4.75V$ to 15V
- $V_{OUT} = 0.85V$
- $I_{OUT-MAX} = 20A$
- $f_{SW} = 500kHz$
- Set to FPWM/CCM mode by default

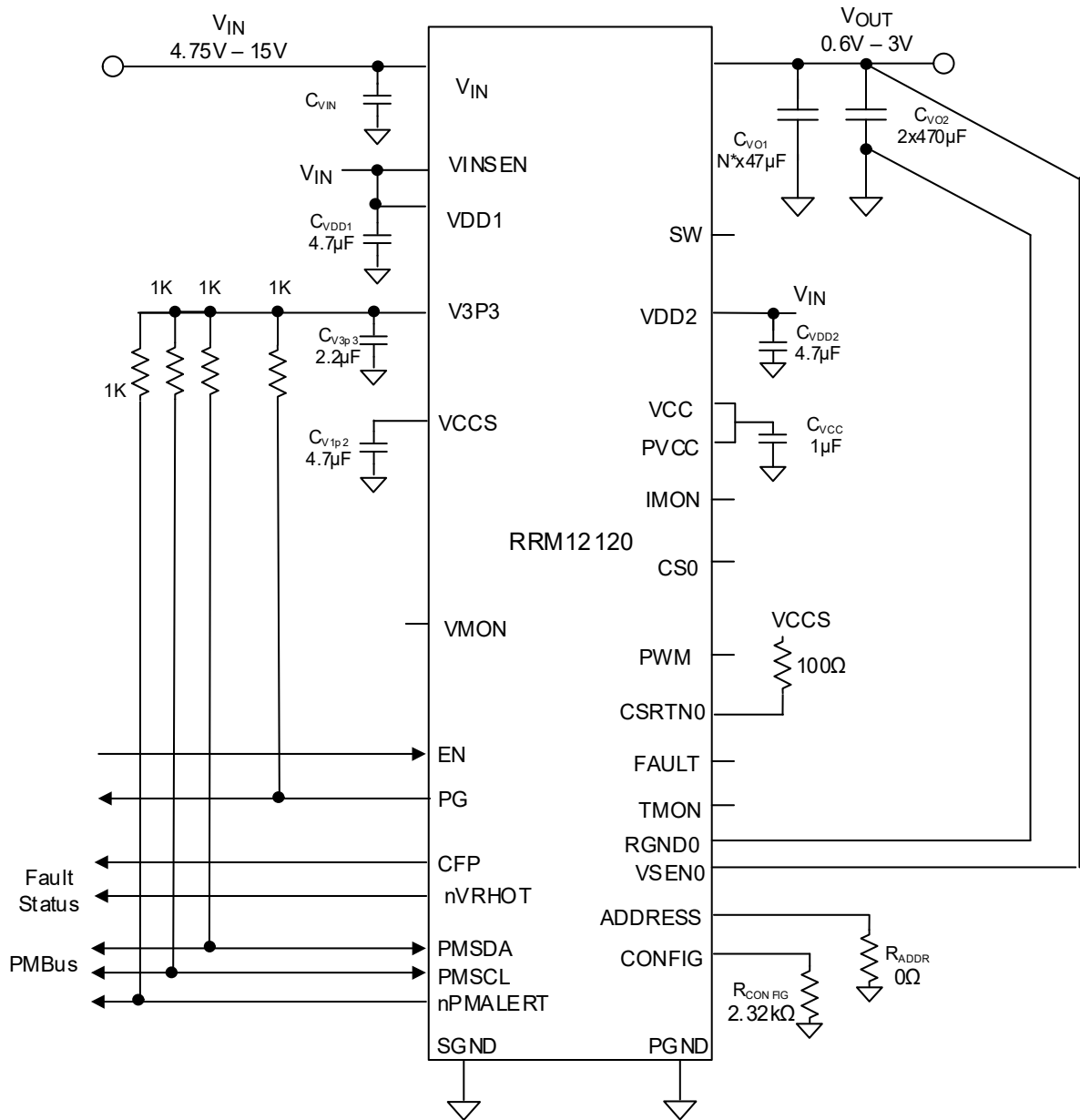

Figure 1. Block Diagram

*See the number of capacitors used in Table 2 for each output voltage.

Contents

1. Functional Description	4
1.1 Setup and Configuration	4
1.2 Configuring for 3.3V Output Application	4
1.3 Configuring for Using External 5V/3.3V Supplies	4
1.4 Selecting User Configurations	4
1.5 Thermal Considerations and Current Derating	5
1.6 Using the PowerNavigator	6
2. Board Design	9
2.1 Layout Guidelines	10
2.2 Schematic Diagram	11
2.3 Board Layout	12
2.4 Bill of Materials	16
3. Typical Performance Graphs	18
4. Ordering Information	22
5. Revision History	22

1. Functional Description

The RTKA12120DE0000BU evaluation board provides the peripheral circuitry to evaluate the feature set of the RRM12120. The evaluation board includes several connectors, test points, a mechanical switch and jumper that simplify the evaluation of the module. When pin Enable is selected in the PowerNavigator, the converter is enabled and disabled by switching the EN pin as shown in [Figure 6](#). Connecting a jumper between pin 1 and 2 of the 3_3V_VIN_OPTION, allows using VIN to power the internal analog 5V and 3.3V supplies (as shown in [Figure 6](#)). The RTKA12120DE0000BU evaluation board has a built-in load transient test circuit which can be used to test the load transient response of the RRM12120 (see [Figure 7](#)). [Figure 6](#) and [Figure 7](#) show the photograph of the top and bottom of the RTKA12120DE0000BU evaluation board.

1.1 Setup and Configuration

1. Disable the module by turning the SW1 switch to the OFF position, shown in [Figure 6](#).
2. Place a jumper between pin1 and 2 of 3_3V_VIN_OPTION.
3. Use the appropriate cables to connect the DC input power supply to banana sockets 12V0 and TP1GND, and the electronic load to sockets J4 and J5 for VOUT and J6 and J7 for GND. Ensure that the polarity for the power leads is correct and the input voltage is within the operating range (4.75V - 15V) of the module. Use test points TP1 (VIN) and TP2 (PGND) for accurately measuring the input voltage.
4. Turn on the input power supply.
5. Turn the switch SW1 to the ON position to enable the module.
6. Probe test points TP3 (VOUT) and TP4 (PGND) to observe the output voltage. The output voltage should read 0.85V.
7. Adjust the input voltage, V_{IN} , within the specified range and observe the output voltage. The output voltage variation should be within $\pm 8\text{mV}$.
8. Adjust the load current to within the specified range (0 - 20A) and observe the output voltage. The output voltage variation should be within $\pm 8\text{mV}$.

1.2 Configuring for 3.3V Output Application

The schematic for RTKA12120DE0000BU evaluation board is shown in [Figure 8](#). To configure for 3.3V output operation, remove R15 and populate R17 with a 499 Ω resistor. Replace R14 with a 0 Ω resistor. Connect a multimeter between TP3 (VOUT) and TP4 (GND). Apply 12V between 12V0 and TP1GND. Turn on the switch SW1 to the ON position and observe 3.3V at the output. See the *RRM12120 Datasheet* for more information on 3.3V operation.

1.3 Configuring for Using External 5V/3.3V Supplies

To configure for using external 5V/3.3V supplies, power down the board and remove the jumper on 3_3V_VIN_OPTION. Apply 5V to the V5P0 test point. Apply 3.3V to the V3P3 test point. See locations of the 3_3V_VIN_OPTION, V3P3 and V5P0 test points in [Figure 6](#).

1.4 Selecting User Configurations

The RRM12120 supports 15 preloaded configuration identifiers with one configuration ID left open. [Table 1](#) provides the R_{CONFIG} value corresponding to each configuration identifier that stores a particular V_{OUT} configuration. A total of 28 one-time programmable non-volatile memory locations exist in the controller, therefore another 13 locations are available to store new user configurations or overwrite existing ones. Only the most recent configuration for a given configuration ID is loaded. When all 28 memory locations have been written, the RRM12120 no longer accepts attempts to write to the NVM. PowerNavigator provides a simple interface to store and load configurations. The corresponding R_{CONFIG} on the RTKA12120DE0000BU evaluation board is R_{14} in the RTKA12120DE0000BU schematic (see [Figure 8](#)).

Table 1. Resistor Value to CONFIG ID Map

R Value (Ω)	Configuration ID	Output Voltage (V)	R Value (Ω)	Configuration ID	Output Voltage (V)
0	0	3.30	1650	8	1.00
162	1	3.00	1960	9	0.90
316	2	2.50	2320	10	0.85
487	3	1.80	2670	11	0.84
681	4	1.70	3090	12	0.82
887	5	1.35	3570	13	0.80
1130	6	1.20	4120	14	0.95
1370	7	1.05	4640	15	Open

See the RRM12120 Design Matrix in [Table 2](#) for recommended minimum V_{IN} , switching frequency, output capacitors combination and other parameters for the various V_{OUT} .

Table 2. RRM12120 Design Matrix (see [Figure 8](#))

V_{IN} min (V)	V_{OUT} (V)	F (kHz)	C_{OUT} (μ F)	R15 (Ω)	R17 (Ω)
4.75	0.6	400	10x47 μ F + 2x470 μ F	2	DNP
4.75	0.8	500	7x47 μ F + 2x470 μ F	2	DNP
4.75	0.9	500	7x47 μ F + 2x470 μ F	2	DNP
4.75	1	500	7x47 μ F + 2x470 μ F	2	DNP
4.75	1.05	500	7x47 μ F + 2x470 μ F	2	DNP
4.75	1.2	550	7x47 μ F + 2x470 μ F	2	DNP
4.75	1.35	600	7x47 μ F + 2x470 μ F	2	DNP
4.75	1.5	600	7x47 μ F + 2x470 μ F	2	DNP
4.75	1.8	600	7x47 μ F + 2x470 μ F	2	DNP
8	2.5	700	7x47 μ F + 2x470 μ F	2	DNP
8	3	700	7x47 μ F + 2x470 μ F	2	DNP
8	3.3	700	15x47 μ F + 2x470 μ F	DNP	499

Note: For the output capacitors in [Table 2](#), use the following capacitor part numbers or similar.

- 47 μ F: GRT21BC80G476ME13L
- 470 μ F: T55D477M6R3C0007

1.5 Thermal Considerations and Current Derating

The board layout is critical so that the module can operate safely and deliver the maximum allowable power. For the board to operate properly at high ambient temperature environments and deliver full load current, the board layout needs to be carefully designed to maximize thermal performance. To achieve this, sufficient trace width, copper weight, and proper connectors have to be used.

The RTKA12120DE0000BU evaluation board is capable of operating at 20A full load current at room temperature without the need for additional cooling systems. However, if the board is to operate at elevated ambient

temperatures, the available output current may need to be derated. See the derated current curves in the *RRM12120 datasheet* to determine the maximum output current that the evaluation board can supply.

1.6 Using the PowerNavigator

RTKA12120DE0000BU can be evaluated for all features using the ISLUSBEVAL1Z dongle and PowerNavigator evaluation software. Complete the following steps to evaluate the RRM12120 with the PMBus option.

1. Install the PowerNavigator software.
2. Set the ENABLE switch to OFF.
3. Connect a load between the VOUT lug connectors (J4 and J5) and GND lug connectors (J6 and J7).
4. Connect a power supply to the VIN and GND connectors (12V0 and TP1GND). Make sure the power supply is not enabled when making the connection.
5. Turn the power supply on.
6. Connect the ISLUSBEVAL1Z dongle (USB to PMBus adapter) to the 6-pin male connector on the RTKA12120DE0000BU evaluation board.
7. Connect the supplied USB cable from the computer through USB to the ISLUSBEVAL1Z dongle.
8. Launch the PowerNavigator software. The PowerNavigator software interface is shown in [Figure 2](#). The module RRM12120 part number and I²C address (0X60) appears under Scan Attached Devices section.

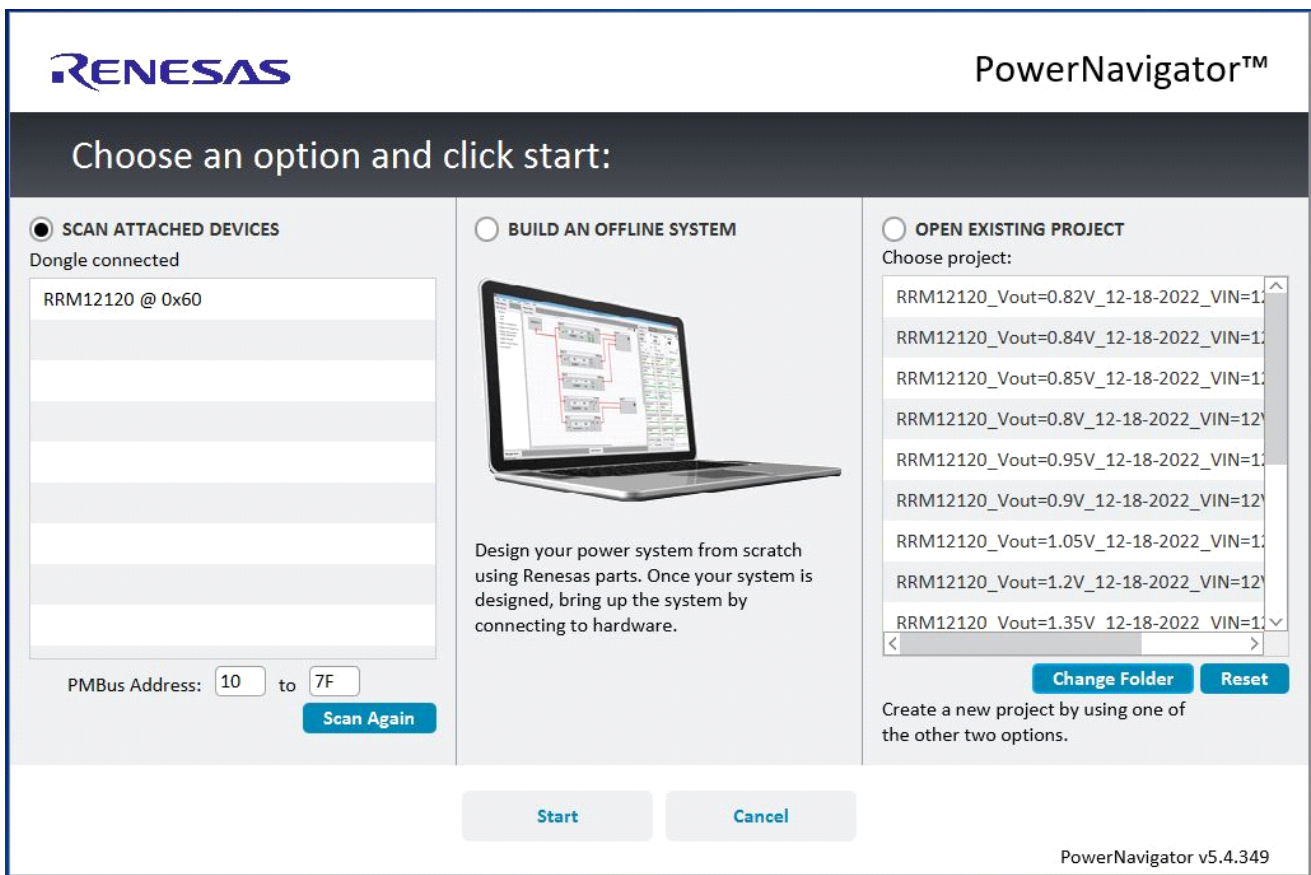

Figure 2. PowerNavigator Start Page

- Hit the **Start** button. Hit **Read Hardware** in the next screen as shown in Figure 3. A new page shown in Figure 4 appears.

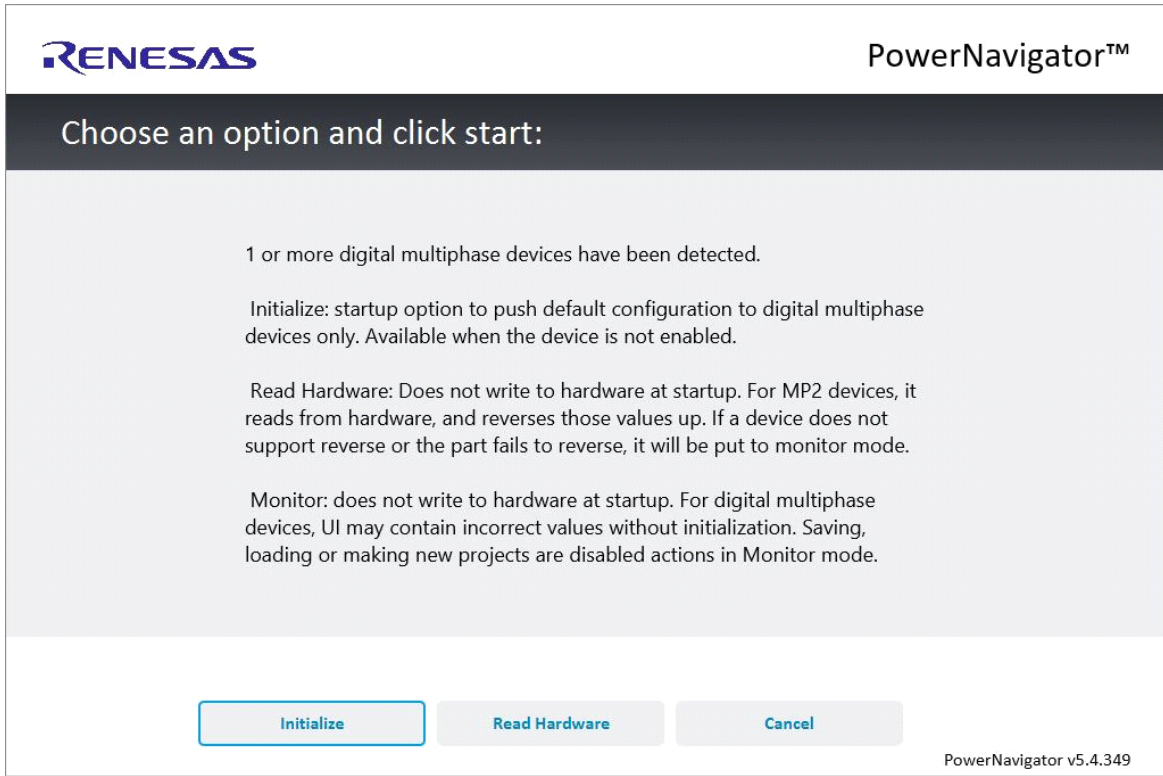

Figure 3. PowerNavigator Initialization Page

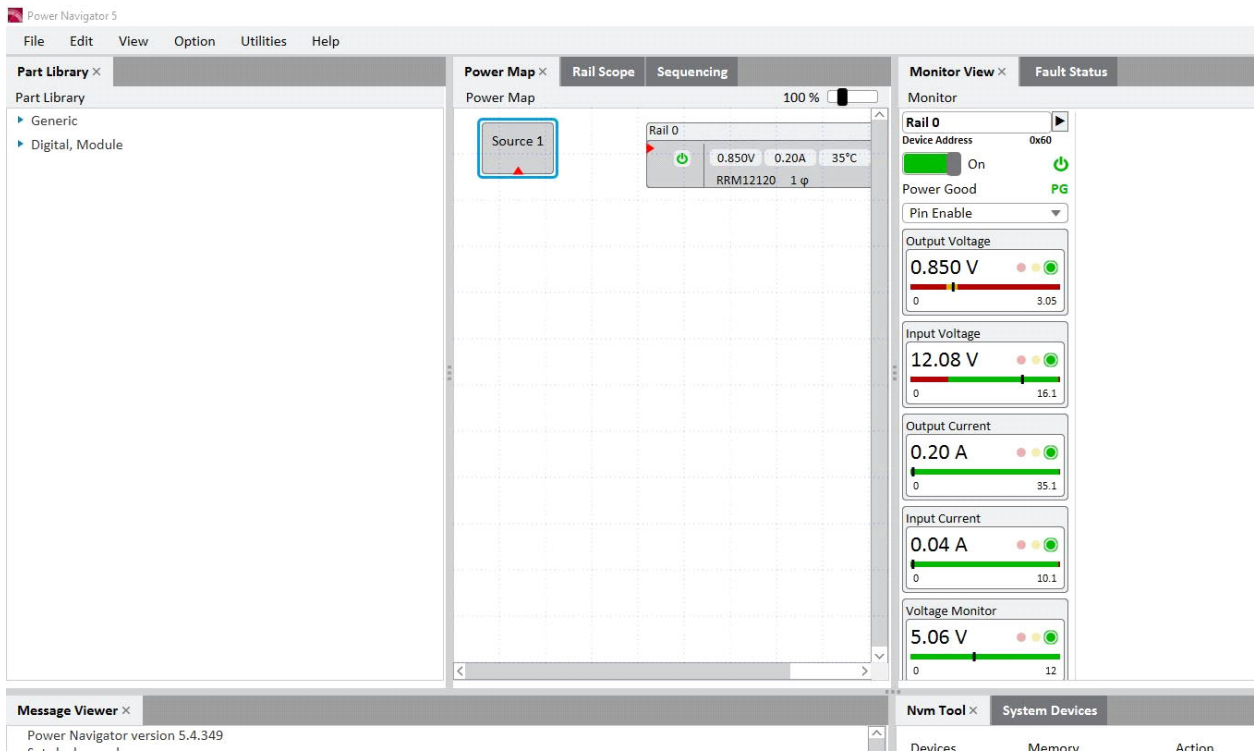

Figure 4. PowerNavigator Monitor View Page

- Double-click on Rail 0 box in the middle panel of the page. A configurations page shown in [Figure 5](#) appears. The items on the left panel can be selected and its associated parameters modified according to your requirements.

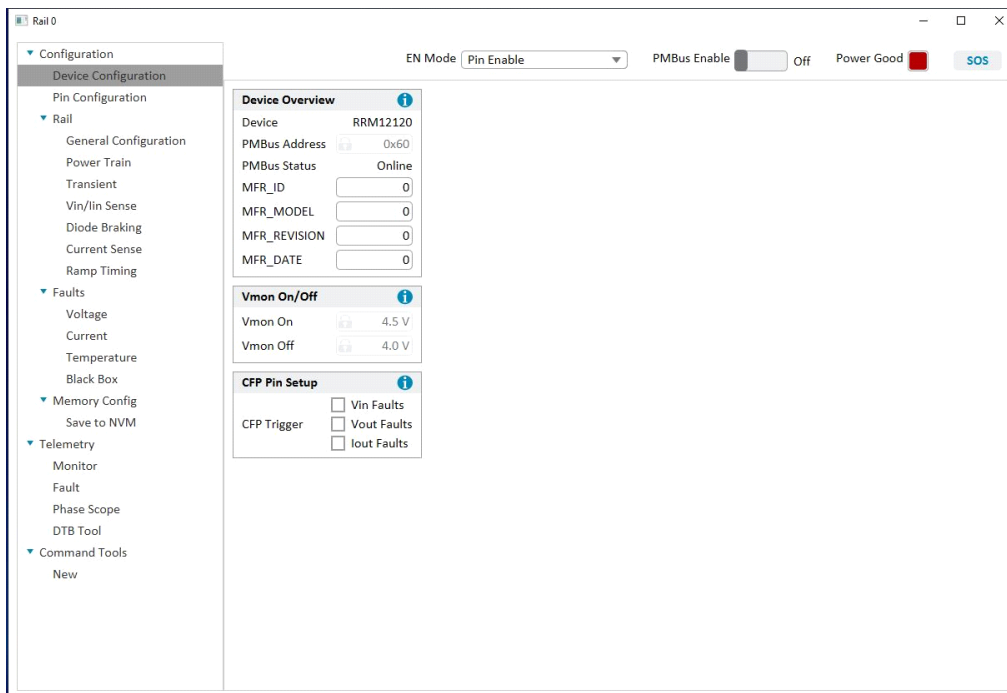

Figure 5. PowerNavigator Configurations Page

- PowerNavigator tutorial videos are available on the Renesas [website](#).

2. Board Design

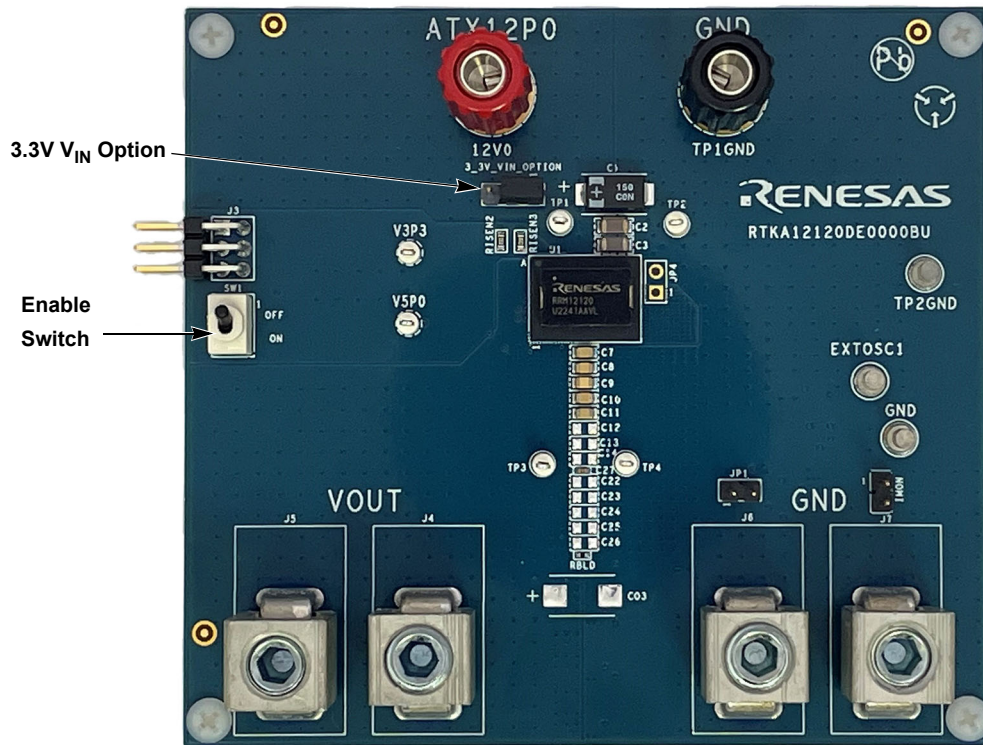

Figure 6. Top of Board

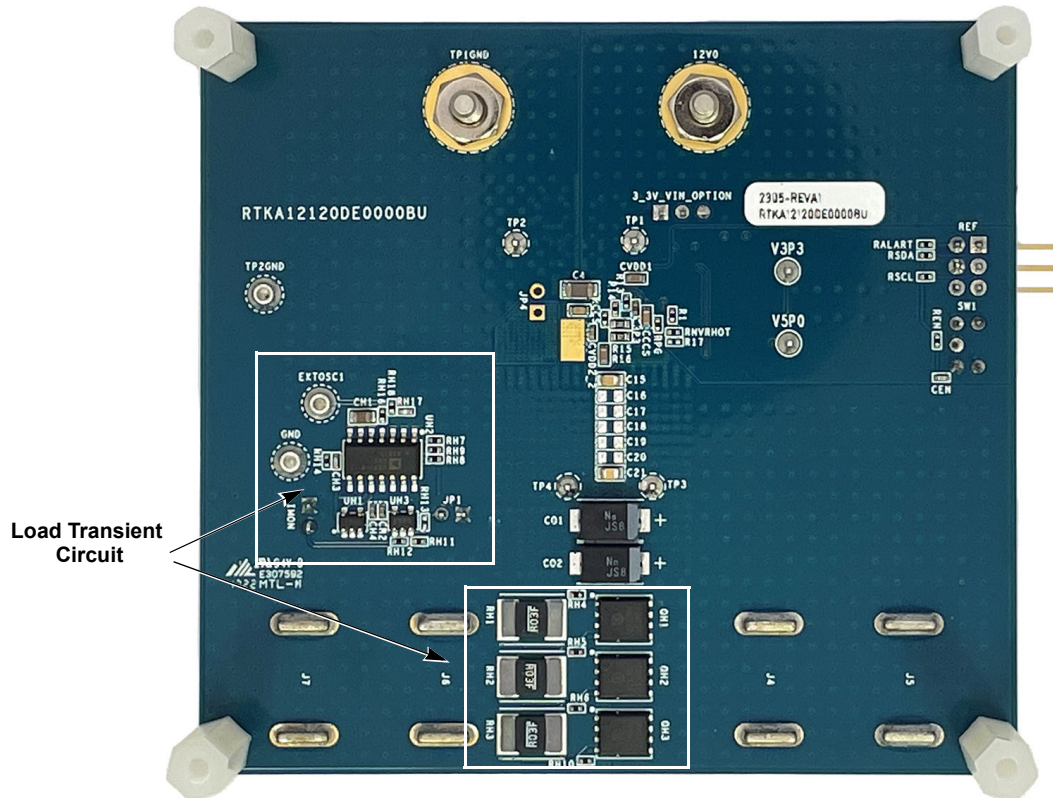

Figure 7. Bottom of Board

2.1 Layout Guidelines

The RTKA12120DE0000BU evaluation board is a 3.8inx3.5in six-layer FR-4 board with 2oz. copper on all the layers. The board can be used as a single 20A reference design.

The RTKA12120DE0000BU evaluation board layout is optimized for electrical performance, low loss, and good thermal performance. Similar performance is obtained for designs involving the RRM12120 while adhering to the layout design tips described in the *RRM12120 Datasheet*.

2.3 Board Layout

See Figure 9 through Figure 16 for board layout for each layer.

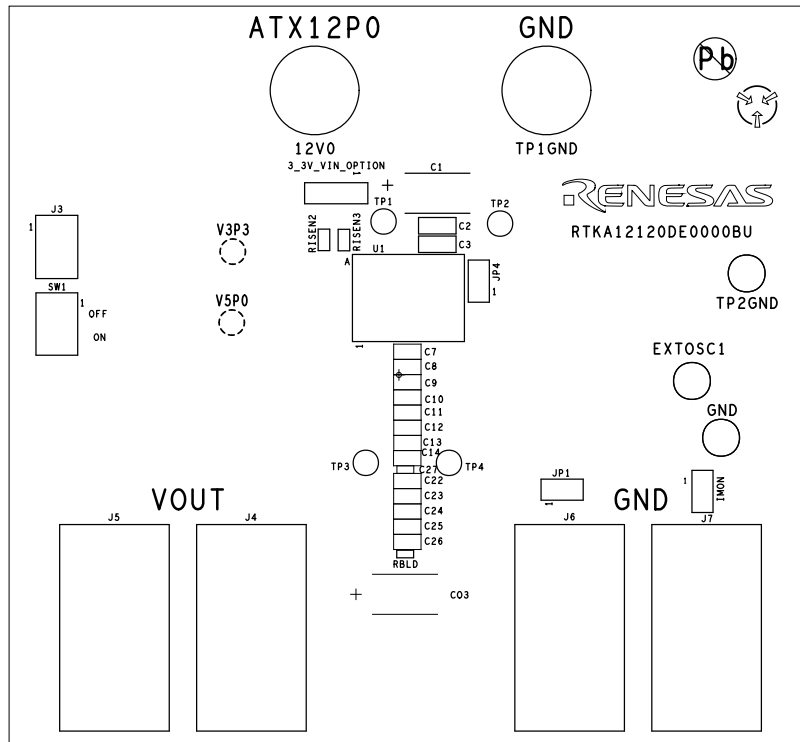

Figure 9. Silkscreen Top

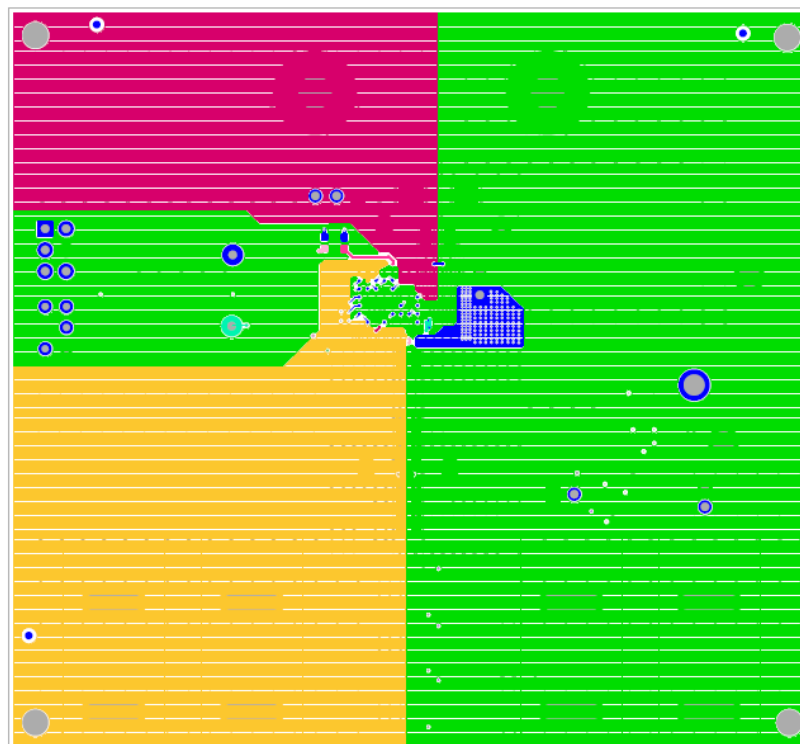

Figure 10. Top Layer Component Side

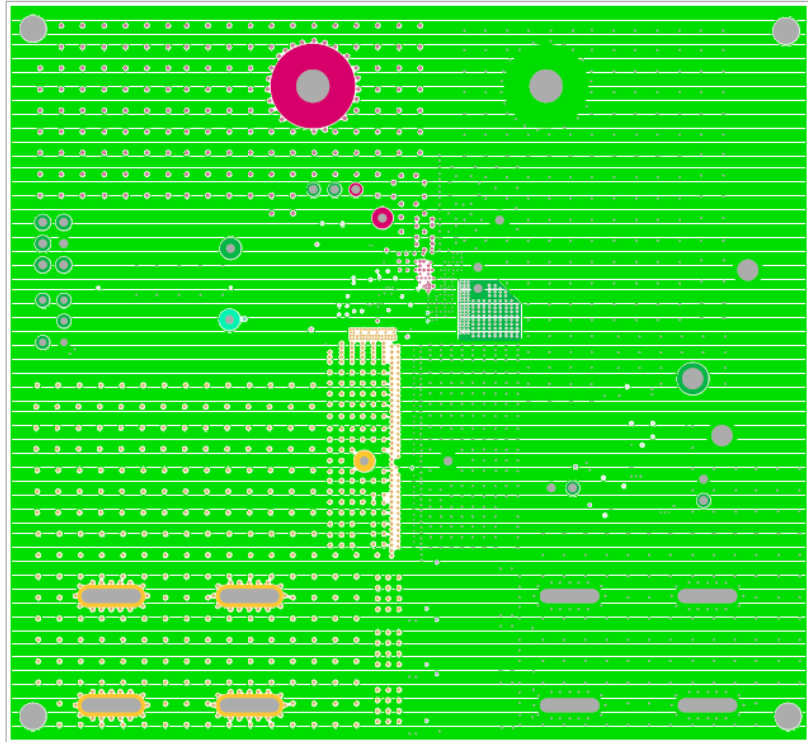

Figure 11. Inner Layer 2

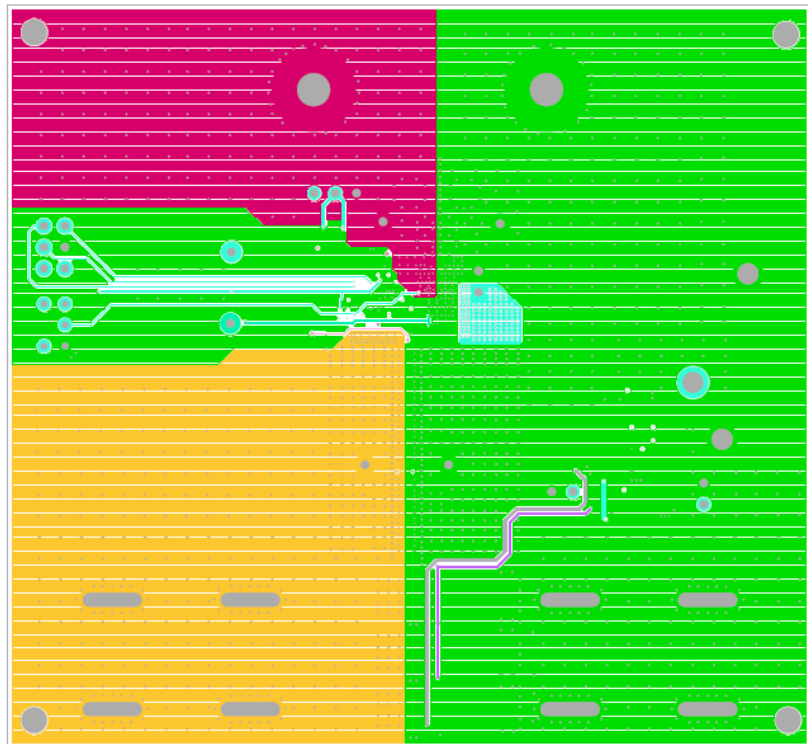

Figure 12. Inner Layer 3

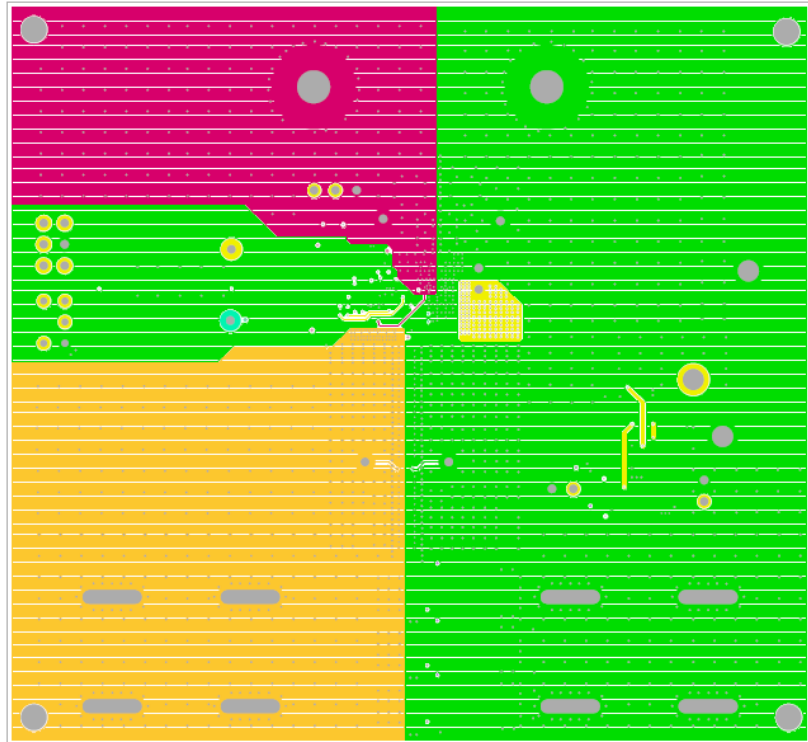

Figure 13. Inner Layer 4

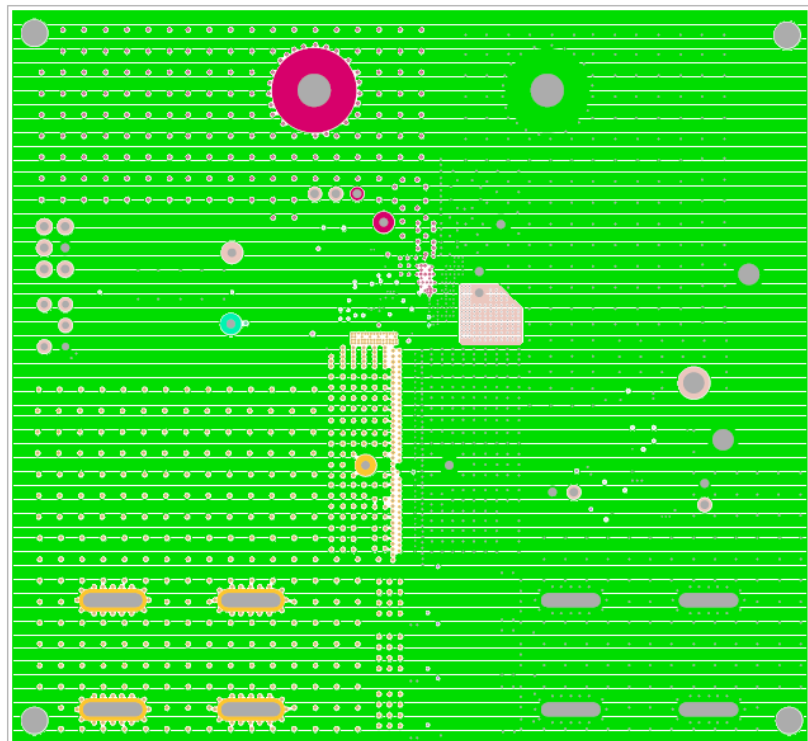

Figure 14. Inner Layer 5

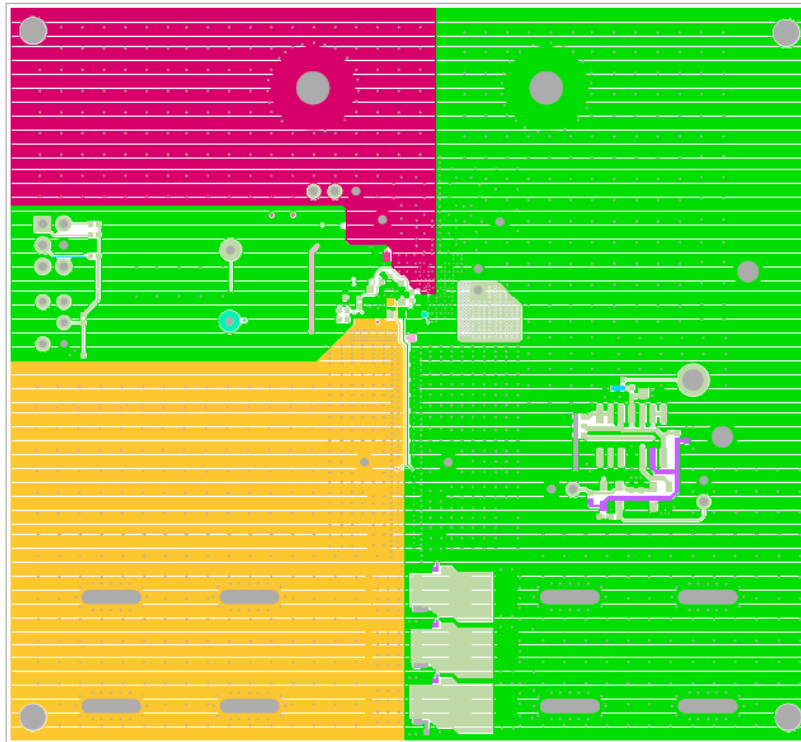

Figure 15. Bottom Layer

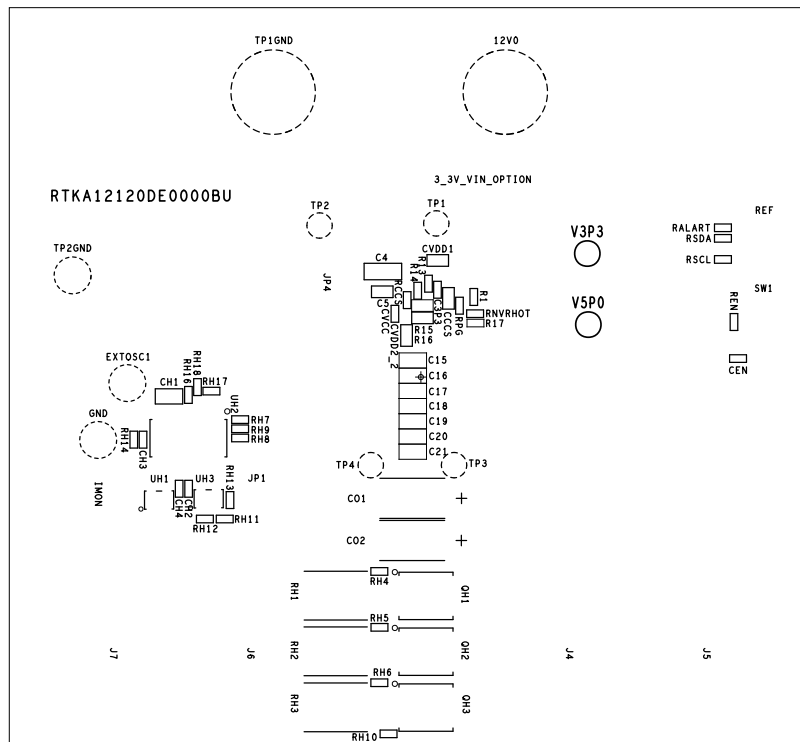

Figure 16. Silkscreen Bottom

2.4 Bill of Materials

Essential components to work with RRM12120 module

Qty	Reference Designator	Description	Manufacturer	Manufacturer Part Number
1	U1	IC-POWER MODULE, 20A DIGITAL PMBus, 130P, BGA, 13×10mm, ROHS	Renesas Electronics	RRM12120-B40
1	C1	CAP-TANT.POSCAP, SMD, 7.3x4.3mm.150µF, 16V, 20%, ROHS	Panasonic	16TDC150MYF
3	C2, C3, C4	CAP, SMD, 1206, 22µF, 25V, 20%, X6S, ROHS	Murata	GRM31CC81E226ME11L
1	C5	CAP-AEC-Q200, SMD, 0603, 1µF, 25V, 10%, X7R, ROHS	Murata	GCM188R71E105KA64D
1	CEN	CAP, SMD, 0402, 470pF, 50V, 5%, C0G/NP0, ROHS	Murata	GRM1555C1H471JA01J
2	C27, CVCC	CAP, SMD, 0402, 1µF, 10V, 10%, X7S, ROHS	Murata	GRM155C71A105KE11D
1	C3p3	CAP, SMD, 0402, 2.2µF, 25V, 20%, X6S, ROHS	Murata	GRM155C81E225ME11D
3	CVDD1, CVDD2_2, CCCS	CAP-AEC-Q200, SMD, 0603, 4.7µF, 25V, 20%, X6S, ROHS	Murata	GRM188C81E475ME11D
7	C7, C8, C9, C10, C11, C15, C21	CAP-AEC-Q200, SMD, 0805, 47µF, 4V, 20%, X6S, ROHS	Murata	GRT21BC80G476ME13L
2	CO1, CO2	CAP-TANT, SMD, 7.3×4.3mm, 470µF, 4V, 20%, 8mΩ DCR, POLYMER, ROHS	Vishay/Sprague	T55D477M004C0008
2	RCCS, RBLD	RES, SMD, 0402, 100Ω, 1/16W, 1%, TF, ROHS	Yageo	RC0402FR-07100RL
2	R15, R16	RES, SMD, 0603, 2Ω, 1/16W, 1%, TF, ROHS	Yageo	RC0603FR-072RL
1	R13,	RES, SMD, 0402, 0Ω, 1/16W, 5%, TF, ROHS	Venkel	CR0402-16W-00T
1	R14	RES-AEC-Q200,SMD, 0402, 2.32K, 1/16W, 1%,TF, ROHS	STACKPOLE	RMCF0402FT2K32
1	REN	RES, SMD, 0402, 1k, 1/16W, 1%, TF, ROHS	Yageo	RC0402FR-071KL

Additional non-essential components, but necessary for RTKA12120DE0000BU board to work.

Qty	Reference Designator	Description	Manufacturer	Manufacturer Part
2	RISEN2, RISEN3	RES, SMD, 0603, 10Ω, 1/10W, 1%, TF, ROHS	Yageo	RC0603FR-0710RL
7	R1, RH11, RSDA, RSCL, RPG, RNVRHOT, RALART	RES, SMD, 0402, 1k, 1/16W, 1%, TF, ROHS	Yageo	RC0402FR-071KL
3	RH1, RH2, RH3	RES-AEC-Q200, SMD, 2816, 0.03Ω, 2W, 1%, CURR.SENSE, ROHS	Vishay/Dale	WSL2816R0300FEH

Qty	Reference Designator	Description	Manufacturer	Manufacturer Part
3	RH4, RH5, RH6	RES-AEC-Q200, SMD, 0402, 9.09k, 1/16W, 1%, TF, ROHS	Vishay/Dale	CRCW04029K09FKED
3	RH7, RH8, RH9	RES-AEC-Q200, SMD, 0402, 3Ω, 1/16W, 1%, TF, ROHS	Vishay/Dale	CRCW04023R00FKED
1	RH10	RES-AEC-Q200, SMD, 0402, 10k, 1/10W, 1%, TF, ROHS	Panasonic	ERJ-2RKF1002X
1	RH12	RES-AEC-Q200, SMD, 0402, 6.98k, 1/16W, 1%, TF, ROHS	Vishay/Dale	CRCW04026K98FKED
1	RH14	RES-AEC-Q200, SMD, 0402, 499Ω, 1/16W, 1%, TF, ROHS	Vishay/Dale	CRCW0402499RFKED
1	RH16	RES, SMD, 0402, 1M, 1/16W, 1%, TF, ROHS	Yageo	RC0402FR-071ML
1	RH17	RES-AEC-Q200, SMD, 0402, 280Ω, 1/16W, 1%, TF, ROHS	Vishay/Dale	CRCW0402280RFKED
1	RH18	RES, SMD, 0402, 1.96k, 1/16W, 1%, TF, ROHS	Yageo	RC0402FR-071K96L
1	CH1	CAP, SMD, 0805, 10μF, 25V, 20%, X6S, ROHS	Murata	GRM21BC81E106ME11L
1	CH3	CAP, SMD, 0402, 100pF, 50V, 10%, X7R, ROHS	Yageo	CC0402KRX7R9BB101
2	CH2, CH4	CAP, SMD, 0402, 0.1μF, 25V, 10%, X7R, ROHS	Murata	GRM155R71E104KE14D
3	QH1, QH2, QH3	TRANSIST-MOS, N-CHANNEL, 8P, PG-TDSON-8, 30V, 44A, ROHS	Infineon Technology	BSC100N03MS G
1	UH1	IC-THERMOSTAT PRE-SET, SMD, 5P, SOT23-5, 120C TRIP PT, ROHS	Texas Instruments	LM26CIM5-ZHA/NOPB
1	UH2	IC-OP AMP, 4-CHANNEL, R/R, 14P, SOIC, ROHS	Analog Devices	ADA4891-4ARZ-R7
1	UH3	IC-OP AMP, SINGLE, R/R, SMD, 5P, SOT-23-5, 2.5V, 1mA, ROHS	Microchip Technology	MCP6021T-E/OT
1	12V0	CONN-GEN, BIND.POST, INSUL-RED, THMBNUT-GND	Johnson Components	111-0702-001
1	TP1GND	CONN-GEN, BIND.POST, INSUL-BLK, THMBNUT-GND	Johnson Components	111-0703-001
3	EXTOSC1, GND, TP2GND	CONN-DBL TURRET, TH, 0.218x0.109 PCB MNT, TIN/BRASS, ROHS	Keystone	1502-2
6	TP1, TP2, TP3, TP4, V3P3, V5P0	CONN-MINI TEST POINT, VERTICAL, WHITE, ROHS	Keystone	5002
1	3_3V_VIN_OPTION	CONN-HEADER, 1x3, BREAKAWY 1x36, 2.54mm, ROHS	BERG/FCI	68000-236HLF
1	J3	CONN-HEADER, TH, 6P, 2x3, R/A, 2.54mm, 0.230x0.120in.ROHS	BERG/FCI	68021-206HLF
2	JP1, IMON	CONN-HEADER, 1x2, RETENTIVE, 2.54mm, 0.230X 0.120, ROHS	BERG/FCI	69190-202HLF

Qty	Reference Designator	Description	Manufacturer	Manufacturer Part
1	3_3V_VIN_OPTION-Pins 1-2	CONN-JUMPER, SHUNT, 2P, 2.54mmPITCH, BLK, 6mm, OPEN, ROHS	Sullins	SPC02SYAN
1	SW1	SWITCH-TOGGLE, THRU-HOLE, 5PIN, SPDT, 3POS, ON-OFF-ON, ROHS	C&K Components	GT13MCBE
4	Four corners	SCREW, 4-40×1/4in, PANHEAD, NYLON, PHILLIPS, ROHS	Building Fasteners	NY PMS 440 0025 PH
4	Four corners	STANDOFF, 4-40×3/4in, F/F, HEX, NYLON, ROHS	Keystone	1902D
4	J4, J5, J6, J7	HDWARE-WIRE LUG, TH, 11.8×10.3mm, HEX SCREW, 2-14AWG, ROHS	International Hydraulics Inc	B2C-PCB-HEX
0	C12, C13, C14, C16, C17, C18, C19, C20, C22, C23, C24, C25, C26	Do Not Populate Or Purchase		
0	JP4	Do Not Populate Or Purchase		
0	R17, RH13	Do Not Populate Or Purchase		

3. Typical Performance Graphs

The following data was acquired using the RTKA12120DE0000BU evaluation board at +25°C ambient and free air 0LFM.

$V_{IN} = VDD1 = VDD2 = 12V$, $T_A = +25^\circ C$, unless otherwise stated.

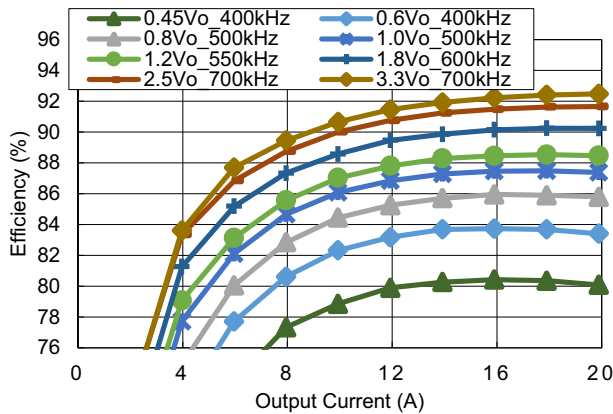

Figure 17. Efficiency vs Load Current at $V_{IN} = 12V$, with Internal 5V and 3.3V Supply

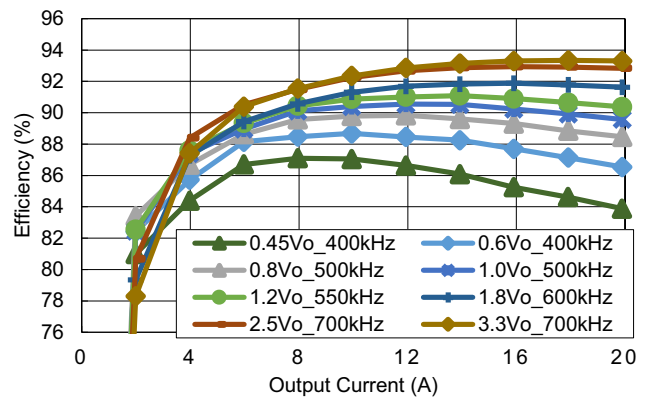

Figure 18. Efficiency vs Load Current at $V_{IN} = 12V$, with External 5V and 3.3V Supply

The following data was acquired using the RTKA12120DE0000BU evaluation board at +25°C ambient and free air 0LFM.

$V_{IN} = V_{DD1} = V_{DD2} = 12V$, $T_A = +25^\circ C$, unless otherwise stated. (Cont.)

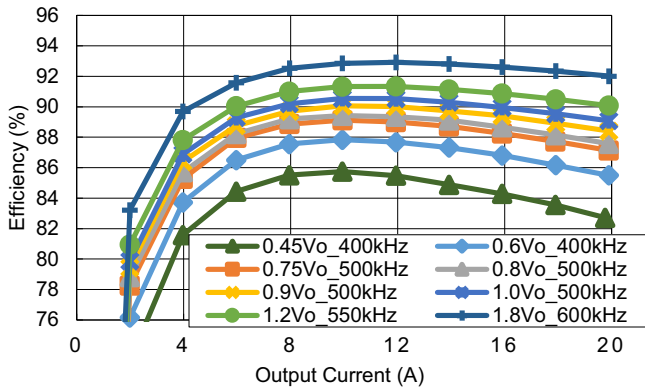

Figure 19. Efficiency vs Load Current at $V_{IN} = 5V$, with Internal 5V and 3.3V Supply

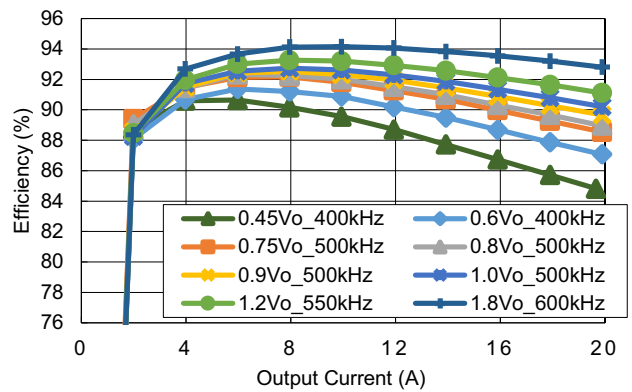

Figure 20. Efficiency vs Load Current at $V_{IN} = 5V$, with External 5V and 3.3V Supply

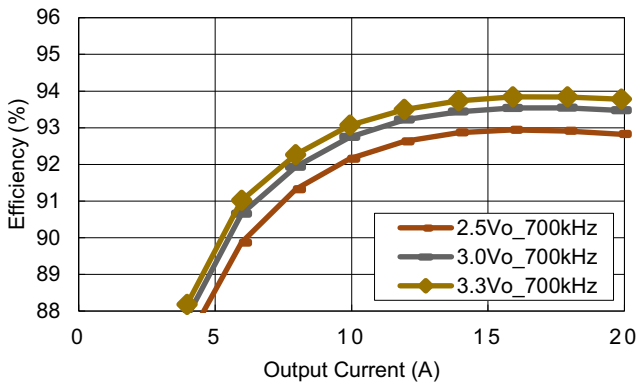

Figure 21. Efficiency vs Load Current at $V_{IN} = 8V$, with Internal 5V and 3.3V Supply

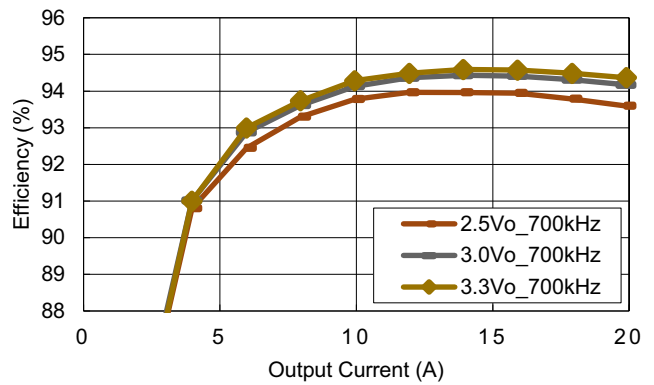

Figure 22. Efficiency vs Load Current at $V_{IN} = 8V$, with External 5V and 3.3V Supply

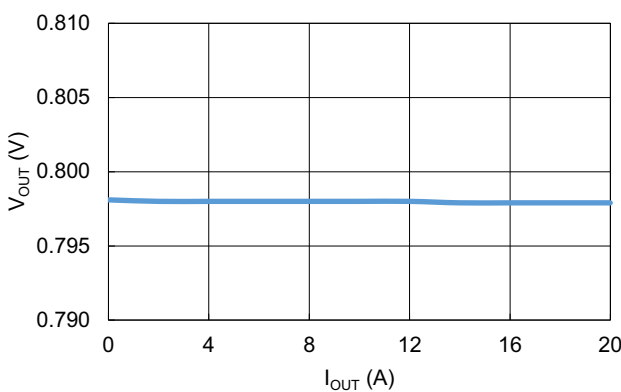

Figure 23. Load Regulation at $V_{IN} = 12V$, $V_{OUT} = 0.8V$, $C_{OUT} = 7 \times 47\mu F$ Ceramic + $2 \times 470\mu F$ Polymer Capacitor, $I_{OUT} = 20A$

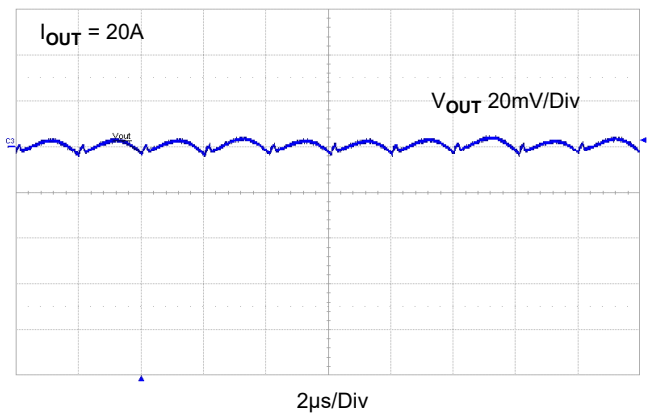

Figure 24. Output Ripple, $V_{IN} = 12V$, $V_{OUT} = 0.8V$, $I_{OUT} = 30A$, $f_{SW} = 500kHz$, $C_{OUT} = 10 \times 47\mu F$ Ceramic + $2 \times 470\mu F$ Polymer Capacitor

The following data was acquired using the RTKA12120DE0000BU evaluation board at +25°C ambient and free air 0LFM.
 $V_{IN} = VDD1 = VDD2 = 12V$, $T_A = +25^\circ C$, unless otherwise stated. (Cont.)

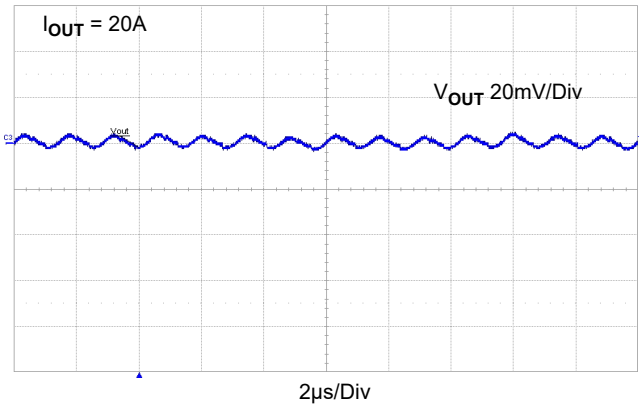

Figure 25. Output Ripple, $V_{IN} = 12V$, $V_{OUT} = 3.3V$, $C_{OUT} = 15 \times 47\mu F$ Ceramic + $2 \times 470\mu F$ Polymer Capacitor

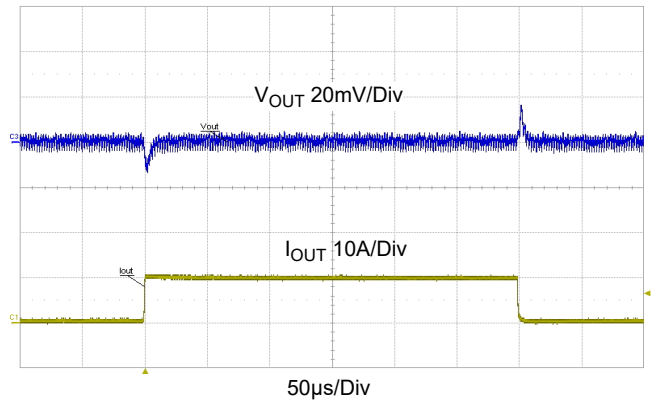

Figure 26. Transient Response, $V_{IN} = 12V$, $V_{OUT} = 0.8V$, 0A to 15A to 0A, $5A/\mu s$ Step Load, $C_{OUT} = 10 \times 47\mu F$ Ceramic + $2 \times 470\mu F$ Polymer Capacitor

Operating condition: $V_{IN} = VDD1 = VDD2 = 12V$, $T_A = +25^\circ C$, unless otherwise stated.

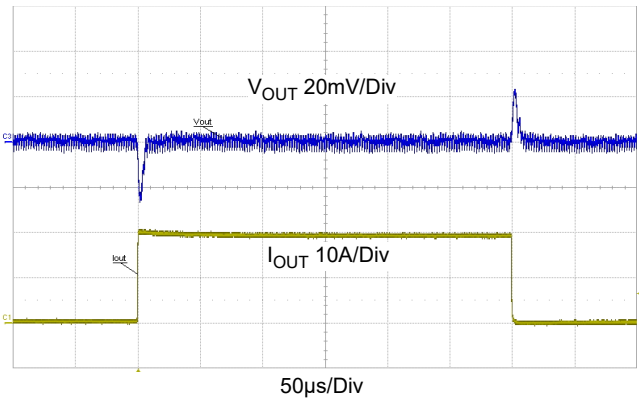

Figure 27. Transient Response, $V_{IN} = 12V$, $V_{OUT} = 0.8V$, 0A to 30A to 0A, $5A/\mu s$ Step Load, $C_{OUT} = 10 \times 47\mu F$ Ceramic + $2 \times 470\mu F$ Polymer Capacitor

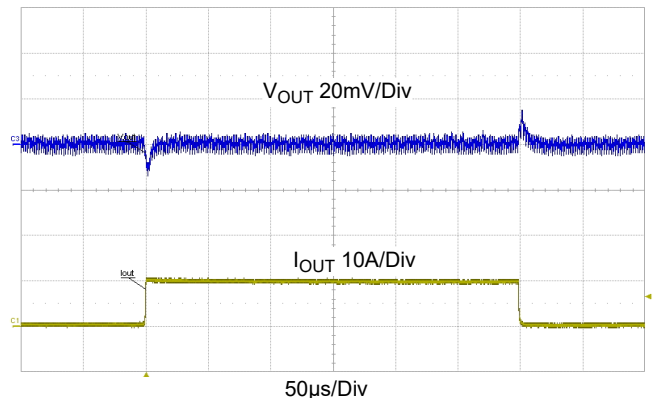

Figure 28. Transient Response, $V_{IN} = 12V$, $V_{OUT} = 1.2V$, 0A to 15A, $5A/\mu s$ Step Load, $C_{OUT} = 7 \times 47\mu F$ Ceramic + $2 \times 470\mu F$ Polymer Capacitor

Operating condition: $V_{IN} = V_{DD1} = V_{DD2} = 12V$, $T_A = +25^{\circ}C$, unless otherwise stated. (Cont.)

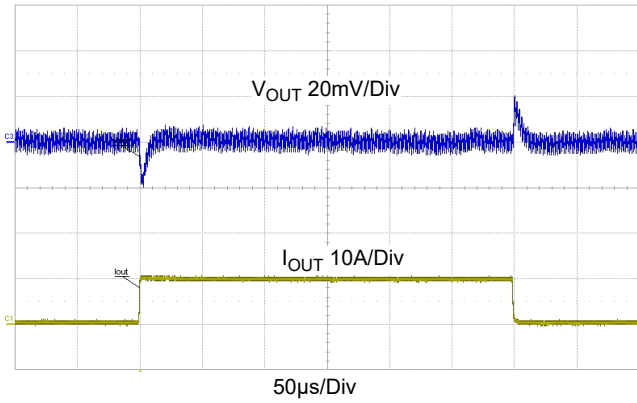

Figure 29. Transient Response, $V_{IN} = 12V$, $V_{OUT} = 1.8V$, 0A to 10A to 0A, 5A/µs Step Load, $C_{OUT} = 7 \times 47\mu F$ Ceramic + 2x470µF Polymer Capacitor

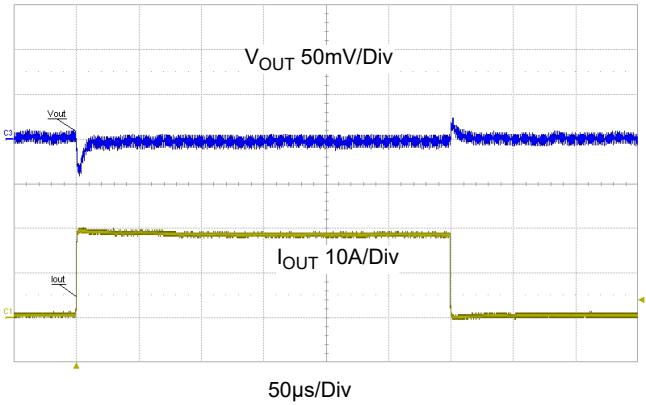

Figure 30. Transient Response, $V_{IN} = 12V$, $V_{OUT} = 3.3V$, 0A to 20A to 0A, 5A/µs Step Load, $C_{OUT} = 15 \times 47\mu F$ Ceramic + 2x470µF Polymer Capacitor

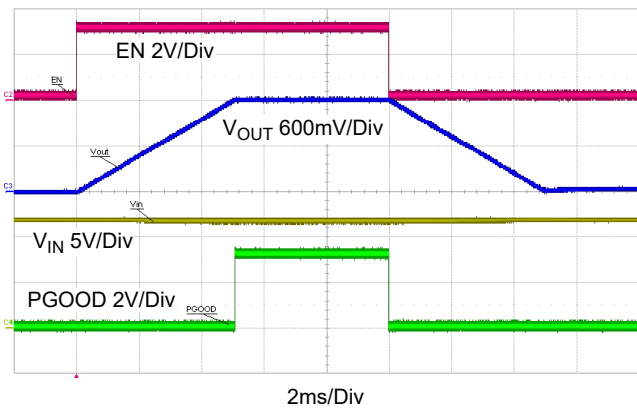

Figure 31. Start-Up and Shutdown Waveform by Pin Enable, $V_{IN} = 12V$, $V_{OUT} = 1.2V$, $I_{OUT} = 20A$

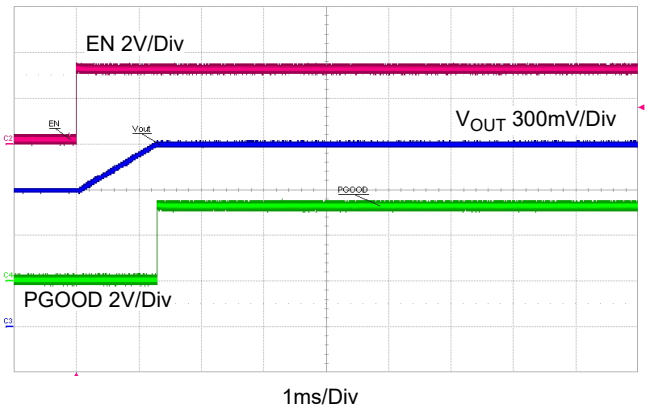

Figure 32. Pre-Biased Startup Waveform, $V_{IN} = 12V$, Pre-Biased Voltage = 0.9V, $V_{OUT} = 1.2V$, $I_{OUT} = 0A$

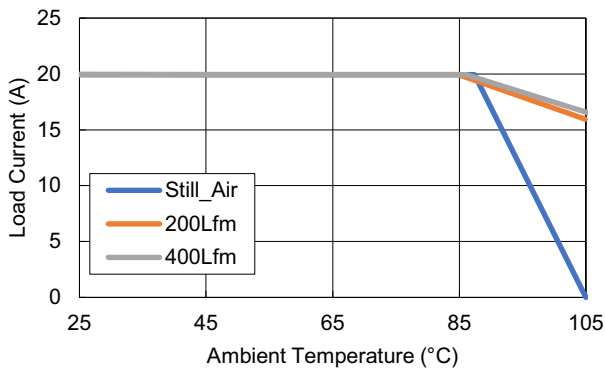

Figure 33. Thermal Derating Curve, $V_{IN} = 12V$, $V_{OUT} = 0.8V$, $f_{SW} = 500kHz$

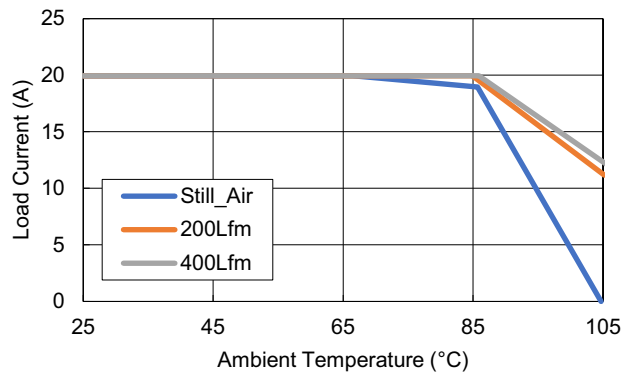

Figure 34. Thermal Derating Curve, $V_{IN} = 12V$, $V_{OUT} = 1.2V$, $f_{SW} = 550kHz$.

Operating condition: $V_{IN} = V_{DD1} = V_{DD2} = 12V$, $T_A = +25^\circ C$, unless otherwise stated. (Cont.)

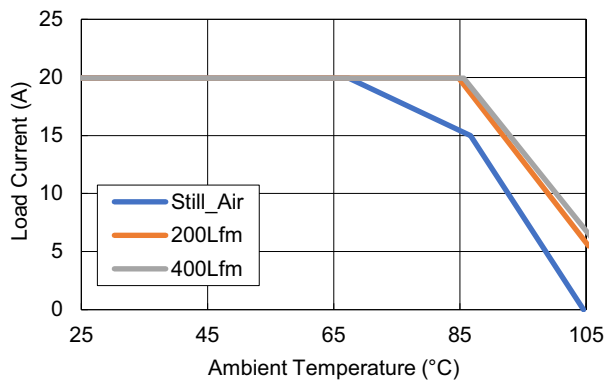

Figure 35. Thermal Derating Curve, $V_{IN} = 12V$, $V_{OUT} = 1.8V$, $f_{SW} = 600kHz$

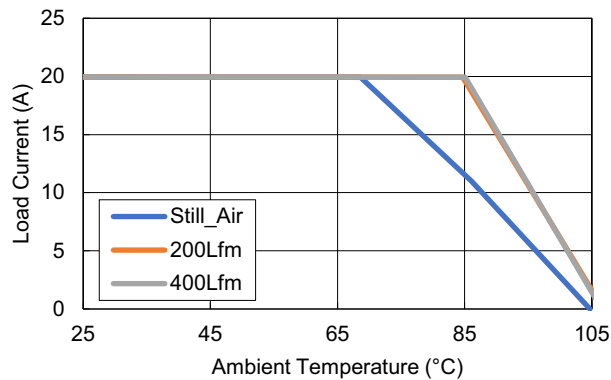

Figure 36. Thermal Derating Curve, $V_{IN} = 12V$, $V_{OUT} = 3.3V$, $f_{SW} = 700kHz$

4. Ordering Information

Part Number	Description
RTKA12120DE0000BU	RRM12120 single 20A power module evaluation board

5. Revision History

Revision	Date	Description
1.00	Feb 22, 2023	Initial release

IMPORTANT NOTICE AND DISCLAIMER

RENESAS ELECTRONICS CORPORATION AND ITS SUBSIDIARIES (“RENESAS”) PROVIDES TECHNICAL SPECIFICATIONS AND RELIABILITY DATA (INCLUDING DATASHEETS), DESIGN RESOURCES (INCLUDING REFERENCE DESIGNS), APPLICATION OR OTHER DESIGN ADVICE, WEB TOOLS, SAFETY INFORMATION, AND OTHER RESOURCES “AS IS” AND WITH ALL FAULTS, AND DISCLAIMS ALL WARRANTIES, EXPRESS OR IMPLIED, INCLUDING, WITHOUT LIMITATION, ANY IMPLIED WARRANTIES OF MERCHANTABILITY, FITNESS FOR A PARTICULAR PURPOSE, OR NON-INFRINGEMENT OF THIRD PARTY INTELLECTUAL PROPERTY RIGHTS.

These resources are intended for developers skilled in the art designing with Renesas products. You are solely responsible for (1) selecting the appropriate products for your application, (2) designing, validating, and testing your application, and (3) ensuring your application meets applicable standards, and any other safety, security, or other requirements. These resources are subject to change without notice. Renesas grants you permission to use these resources only for development of an application that uses Renesas products. Other reproduction or use of these resources is strictly prohibited. No license is granted to any other Renesas intellectual property or to any third party intellectual property. Renesas disclaims responsibility for, and you will fully indemnify Renesas and its representatives against, any claims, damages, costs, losses, or liabilities arising out of your use of these resources. Renesas' products are provided only subject to Renesas' Terms and Conditions of Sale or other applicable terms agreed to in writing. No use of any Renesas resources expands or otherwise alters any applicable warranties or warranty disclaimers for these products.

(Disclaimer Rev.1.0 Mar 2020)

Corporate Headquarters

TOYOSU FORESIA, 3-2-24 Toyosu,
Koto-ku, Tokyo 135-0061, Japan
www.renesas.com

Contact Information

For further information on a product, technology, the most up-to-date version of a document, or your nearest sales office, please visit:
www.renesas.com/contact/

Trademarks

Renesas and the Renesas logo are trademarks of Renesas Electronics Corporation. All trademarks and registered trademarks are the property of their respective owners.