

RTKA808013DE0000BU

The RTKA808013DE0000BU evaluation board is a 3A synchronous buck regulator with an input range of 2.7V to 5.5V. The board evaluates the performance of the [RAA808013](#) high-efficiency low BOM count Sync Buck Regulator with 3A output current.

The RTKA808013DE0000BU is offered in a 6-lead TSOT23 package with 1.1mm maximum height. The converter occupies 1.516cm² area.

Specifications

This board is optimized for the following operating conditions:

- Input voltage: 2.7V ~ 5.5V_{DC}
- Output voltage: 1.2V_{DC}
- Output current: 3A max
- Output power: 3.6W
- Efficiency: 91% at 0.6A, 87% at 1.5A, 83% at 2.4A
- High switching frequency: 1.5MHz
- Load regulation: ±0.5% at 25°C
- Operating temperature: -40°C to 85°C
- Board dimension: 76.2mm×63.5mm

Features

- 2.7V to 5.5V operating input range
- Continuous output current up to 3A
- 77mΩ and 42mΩ internal power MOSFET switches
- Output adjustable from 0.6V
- 100% duty cycle in dropout
- High switching frequency (1.5MHz)
- Fixed soft-start time
- Cycle-by-cycle overcurrent protection
- OCP and SCP with Hiccup mode
- Input undervoltage lockout (UVLO)
- Over-temperature protection
- EN for power sequencing

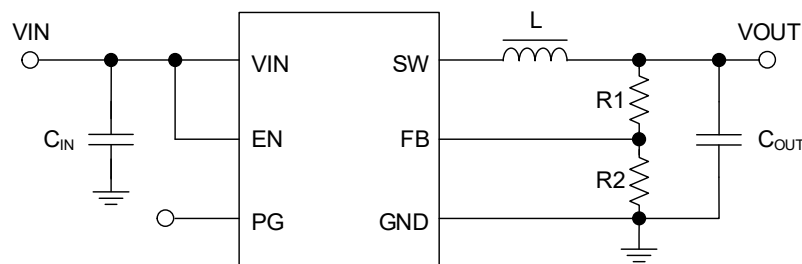

Figure 1. Block Diagram

Contents

1. Functional Description	3
1.1 Recommended Equipment	3
1.2 Quick Start Guide	3
1.3 Evaluating the Other Output Voltage	3
2. Board Design	4
2.1 Layout Guidelines	4
2.2 Schematic Diagrams	5
2.3 Bill of Materials	5
2.4 Board Layout	6
3. Typical Performance Graphs	7
4. Ordering Information	11
5. Revision History	11

1. Functional Description

1.1 Recommended Equipment

The following materials are recommended to perform testing:

- 0V to 6V power supply with at least 15A source current capability
- Electronic loads capable of sinking current up to 15A
- Digital multimeters (DMMs)
- 100MHz quad-trace oscilloscope
- Signal generator

1.2 Quick Start Guide

1. Ensure that the circuit is correctly connected to the supply and loads before applying any power.
2. Connect the bias supply to VIN, the plus terminal to VIN+ and the negative return to VIN-.
3. Turn on the power supply (Recommend $V_{INMAX} = <5.5V$).
4. Verify the output voltage is 1.2V for V_{OUT} .

1.3 Evaluating the Other Output Voltage

The RTKA808013DE0000BU output is preset to 1.2V; however, output voltages can be adjusted from 0.6V to 3.3V. The output voltage programming resistor, R_1 , depends on the required output voltage of the regulator and the value of the feedback resistor R_2 , as shown in [Equation 1](#).

$$(EQ. 1) \quad R_2 = \frac{R_1 \times 0.6V}{V_{OUT} - 0.6V}$$

[Table 1](#) shows the component selection that should be used for the respective V_{OUTs} .

Table 1. External Component Selection

V_{OUT} (V)	L (μ H)	C_{OUT} (μ F)	R_1 (k Ω)	R_2 (k Ω)
0.6	1	22 \times 2	0	51
	2.2	22		
1.0	1	22 \times 2	34	51
	2.2	22		
1.2	1	22	51	51
	2.2	10		
1.8	1	22	102	51
	2.2	10		
2.5	1	22	162	51
	2.2	10		
3.3	1	22	229	51
	2.2	10		

2. Board Design

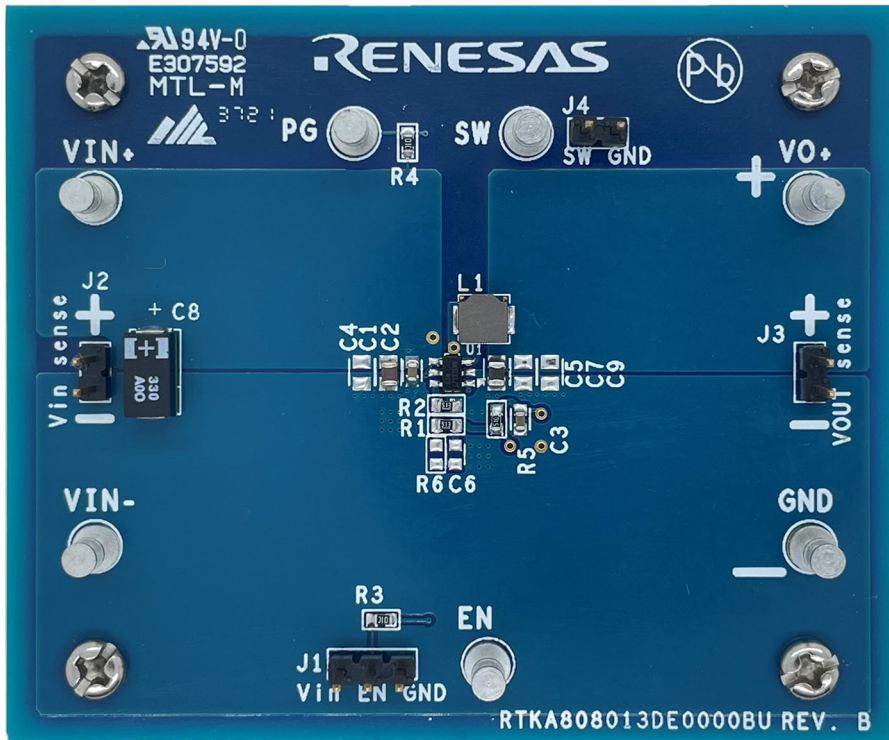

Figure 2. RTKA808013DE0000BU Evaluation Board (Top)

2.1 Layout Guidelines

The following are PCB guidelines to consider when laying out the board.

- Place the input ceramic capacitors between VIN and GND pins. Put them as close to the pins as possible.
- A 0.1 μ F decoupling input ceramic capacitor is recommended. Place it as close to the VIN pin as possible.
- Keep the switching node (SW) plane away from the feedback network. Place the resistor divider close to the IC.

2.2 Schematic Diagrams

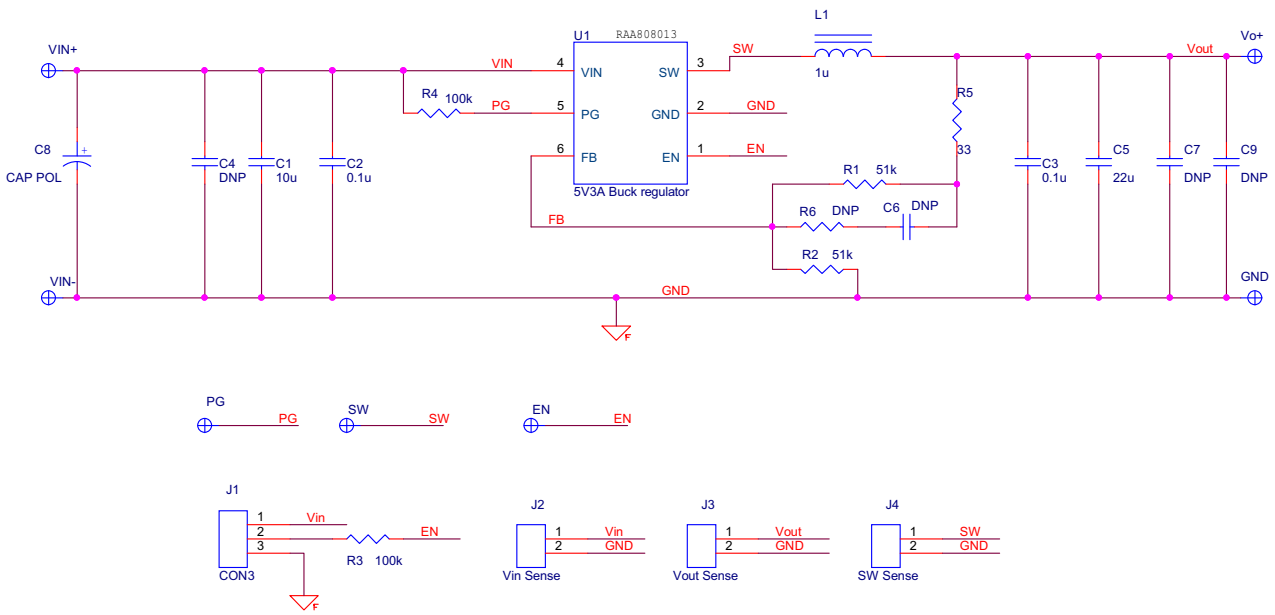

Figure 3. Schematic

2.3 Bill of Materials

Qty	Reference Designator	Description	Manufacturer	Manufacturer Part
1	U1	IC 3A Buck Regulator TSOT23-6, ROHS	Renesas	RAA808013GP3#JA0
2	C1	CAP, SMD, 0805, 10μF, 10V, 10%, X7R, ROHS	TDK Corporation	C2012X7R1A106K125AC
2	C2, C3	CAP, SMD, 0603, 0.1μF, 100V, 10%, X7R, ROHS	Murata Electronics	GRM188R72A104KA35J
2	C5	CAP, SMD, 0805, 22μF, 10V, 10%, X7R, ROHS	Murata Electronics	GRM21BZ71A226ME15L
		CAP, SMD, 0805, 22μF, 10V, 20%, X7S, ROHS	TDK Corporation	C2012X7S1A226M125AC
1	R1	RES, SMD, 0603, 51k, 1/10W, 1%, TF, ROHS	Yageo	RC0603FR-0751KL
1	R2	RES, SMD, 0603, 51k, 1/10W, 1%, TF, ROHS	Yageo	RC0603FR-0751KL
2	R3, R4	RES SMD 100kΩ 1% 1/10W 0603	Yageo	RT0603FRD07100KL
1	R5	RES SMD 33Ω 1% 1/10W 0603	Yageo	RC0603FR-0733RL
7	EN, GND, PG, SW, VIN, VO-, VO+	TERM TURRET SINGLE L = 7.14MM TIN, ROHS	Keystone	1514-2
1	J1	CONN-HEADER, 1×3, BREAKAWY 1×36, 2.54mm, ROHS	BERG/FCI	68000-236HLF
3	J2, J3, J4	CONN-HEADER, 1×2, BREAKAWY 1×36, 2.54mm, ROHS	BERG/FCI	69190-202HLF

Qty	Reference Designator	Description	Manufacturer	Manufacturer Part
1	L1	FIXED IND 1 μ H 7.2A 12 M Ω SMD, ROHS	Würth Elektronik	74438356010
		FIXED IND 1 μ H 5.6A 25.5M Ω SMD, ROHS	TDK Corporation	SPM4020T-1R0M-LR
		FIXED IND 1 μ H 11.7A 7.6M Ω SMD, ROHS	Sunlord Electronics	WTX0420T1R0MTR01
1	C8	330 μ F Molded Tantalum Polymer Capacitor 10V (7343 Metric) 35m Ω at 100kHz	Panasonic	10THB330M

2.4 Board Layout

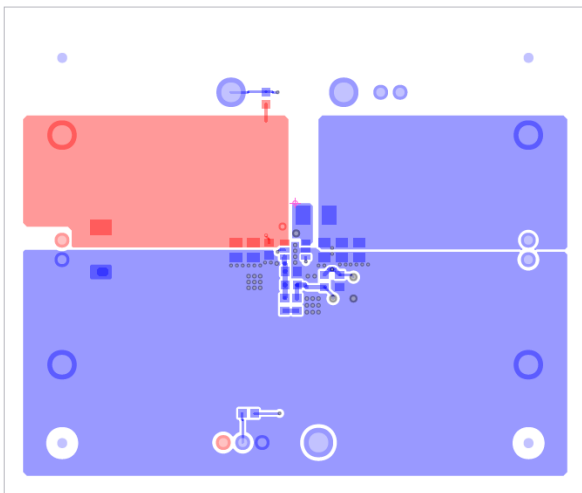

Figure 4. Top Layer

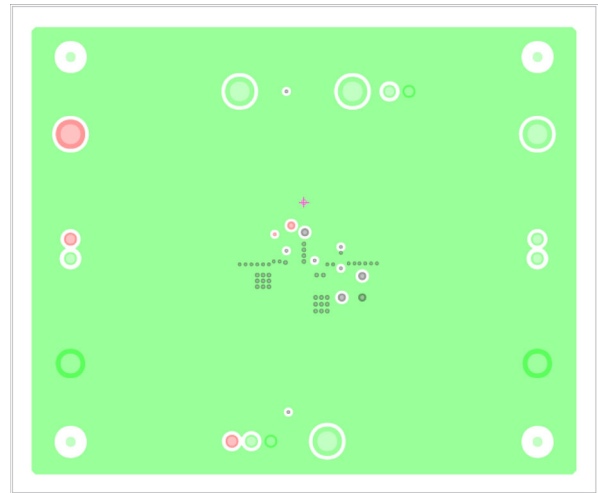

Figure 5. Internal Layer 1

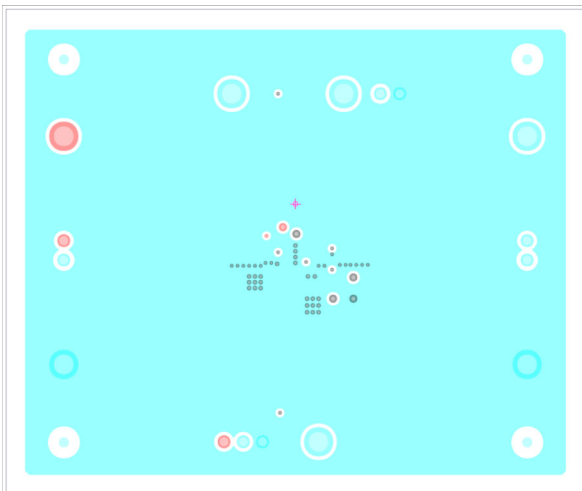

Figure 6. Internal Layer 2

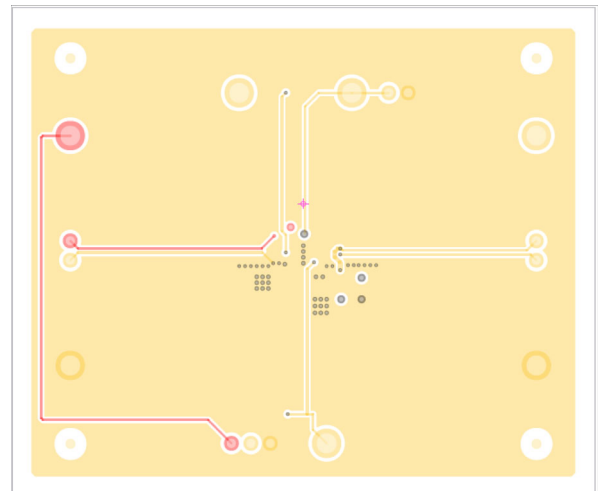

Figure 7. Bottom Layer

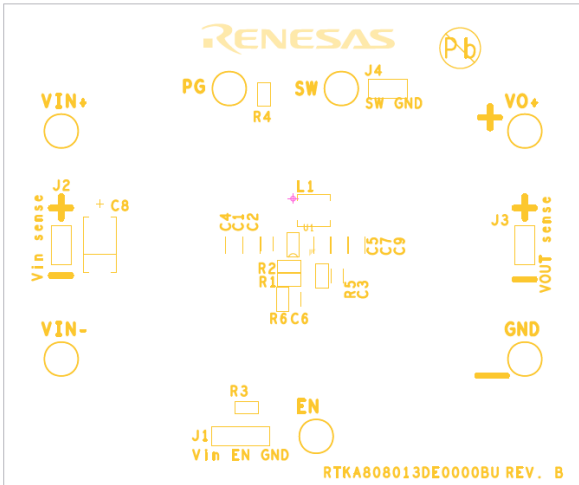

Figure 8. Silkscreen - Top Layer

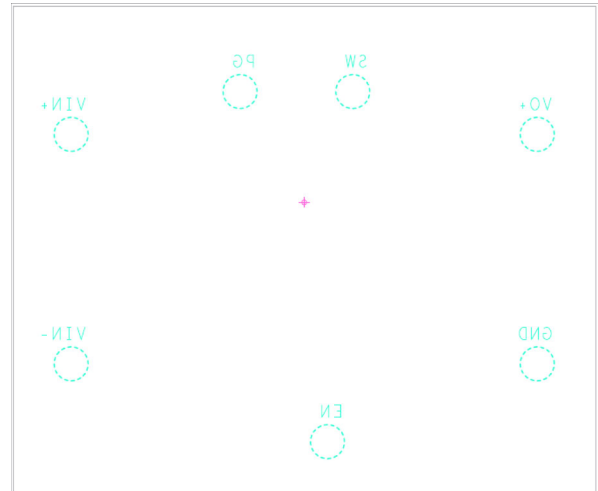

Figure 9. Silkscreen - Bottom Layer

3. Typical Performance Graphs

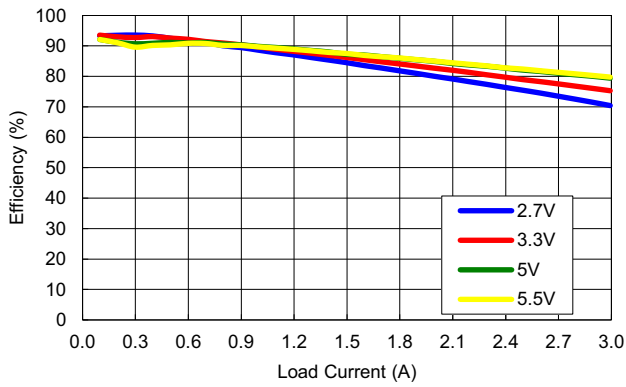

Figure 10. Efficiency vs Load, $V_{OUT} = 1.2V$, 25°C

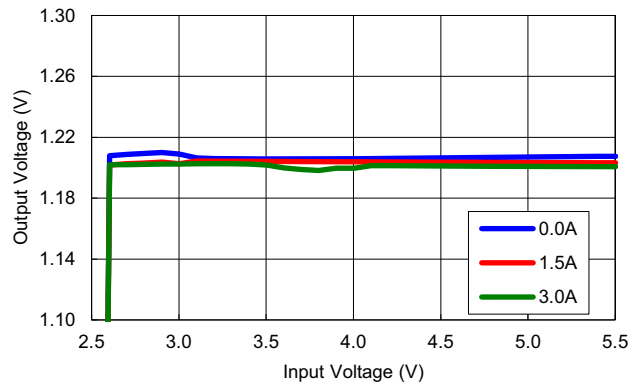

Figure 11. Line Regulation, $V_{OUT} = 1.2V$, 25°C

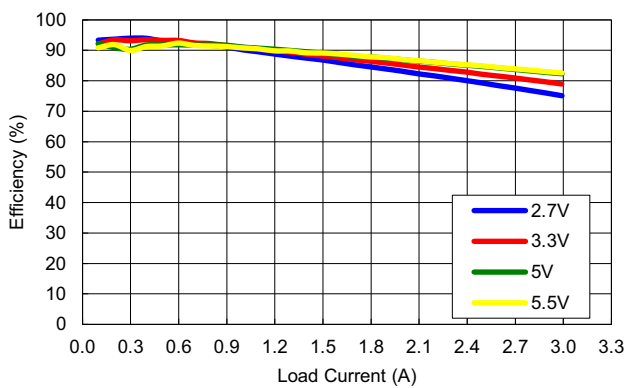

Figure 12. Efficiency vs Load, $V_{OUT} = 1.2V$, -40°C

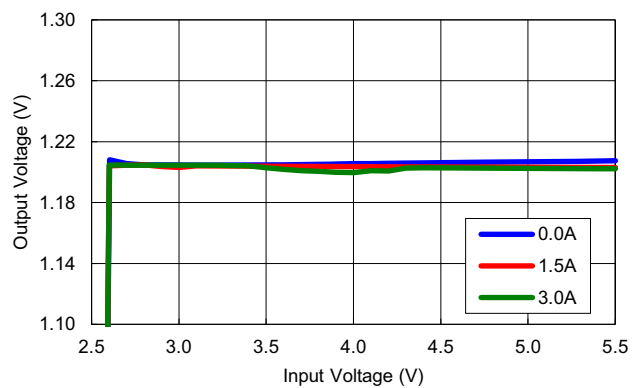

Figure 13. Line Regulation, $V_{OUT} = 1.2V$, -40°C

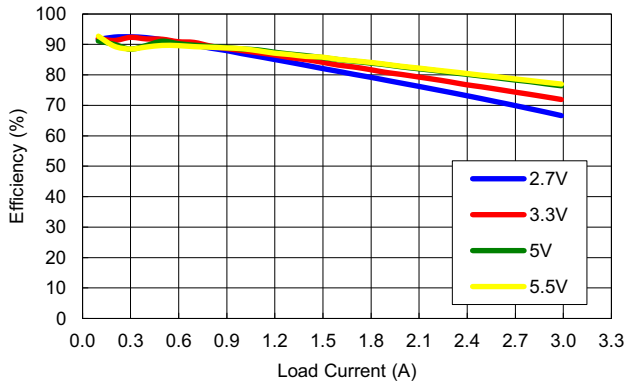

Figure 14. Efficiency vs Load, $V_{OUT} = 1.2V$, $85^{\circ}C$

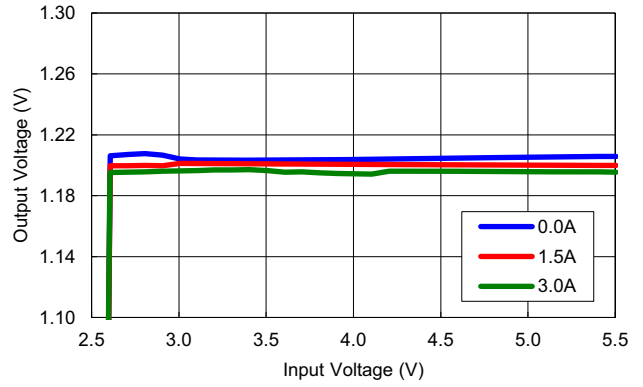

Figure 15. Line Regulation, $V_{OUT} = 1.2V$, $85^{\circ}C$

$V_{IN} = 5V$, $V_{OUT} = 1.2V$, $T_A = +25^{\circ}C$.

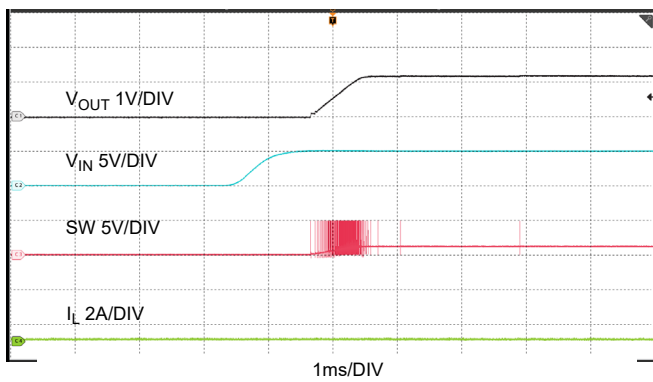

Figure 16. Startup at 0A

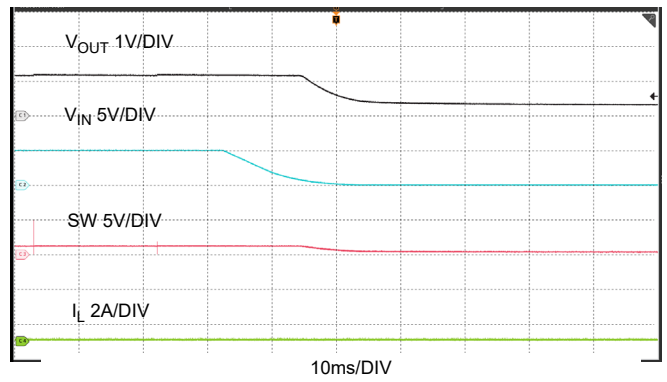

Figure 17. Shutdown at 0A

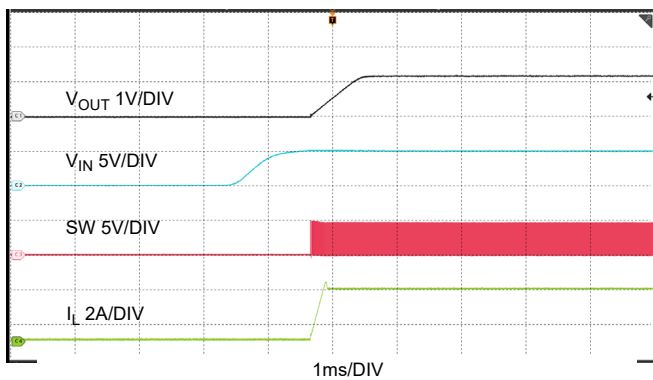

Figure 18. Startup at 3A

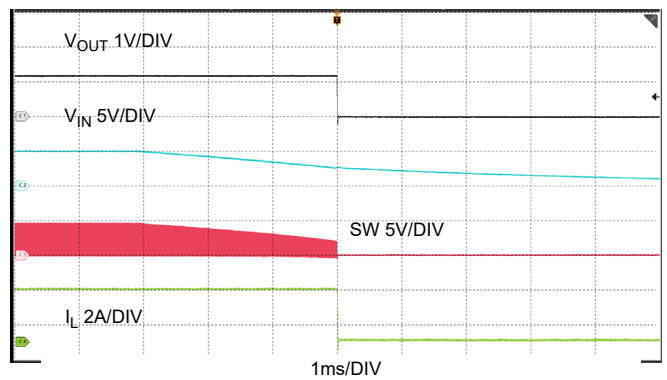

Figure 19. Shutdown at 3A

$V_{IN} = 5V$, $V_{OUT} = 1.2V$, $T_A = +25^{\circ}C$. (Cont.)

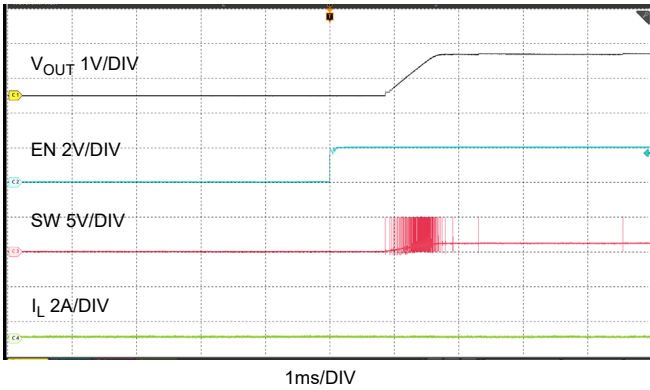

Figure 20. EN on at 0A

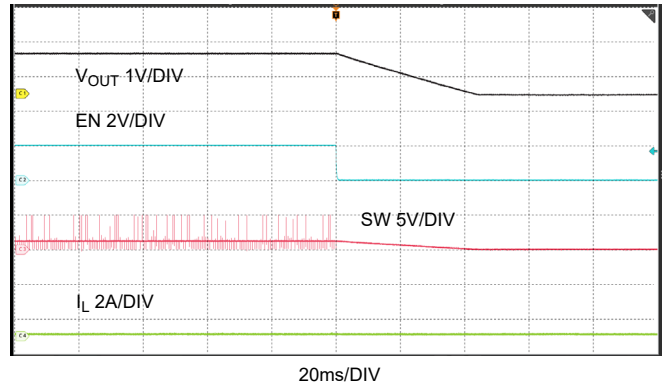

Figure 21. EN off at 0A

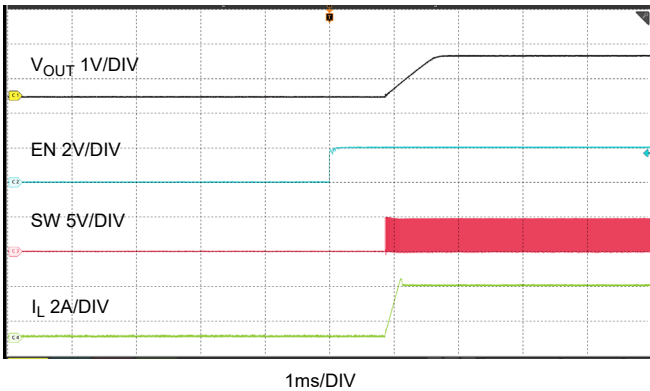

Figure 22. EN on at 3A

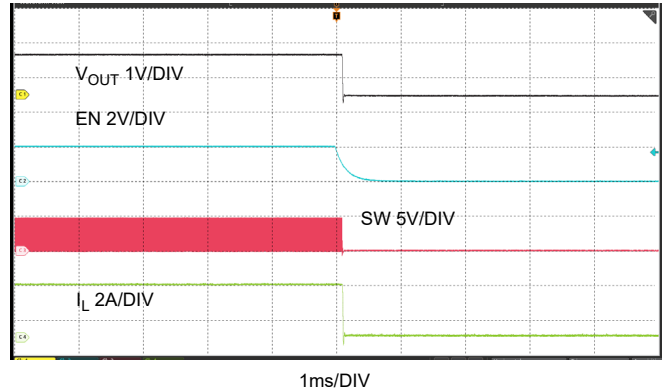

Figure 23. EN off at 3A

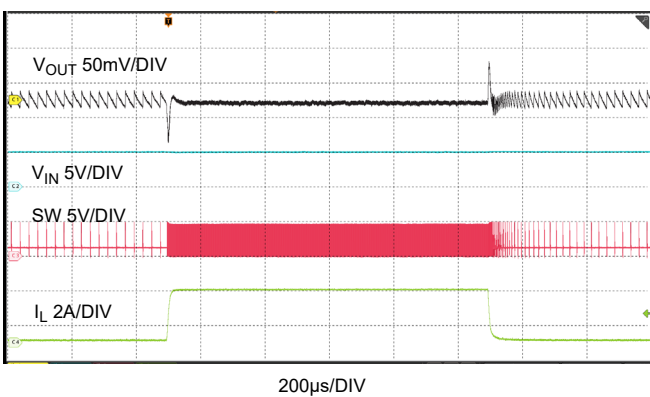

Figure 24. Load Transition, 0A->3A

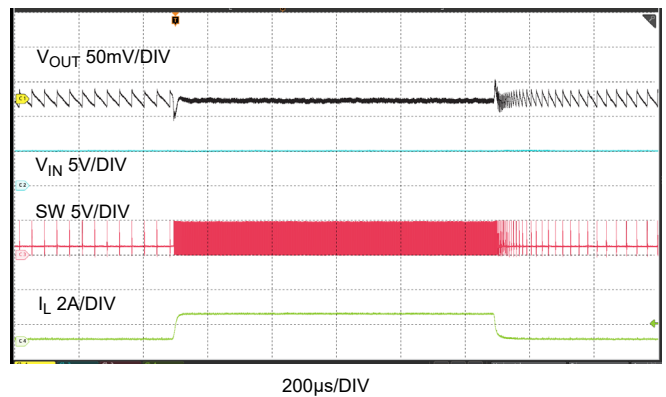

Figure 25. Load Transition, 0A->1.5A

$V_{IN} = 5V$, $V_{OUT} = 1.2V$, $T_A = +25^{\circ}C$. (Cont.)

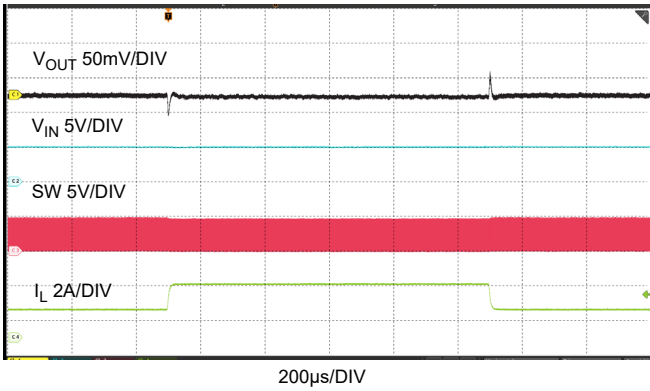

Figure 26. Load Transition, 1.5A->3A

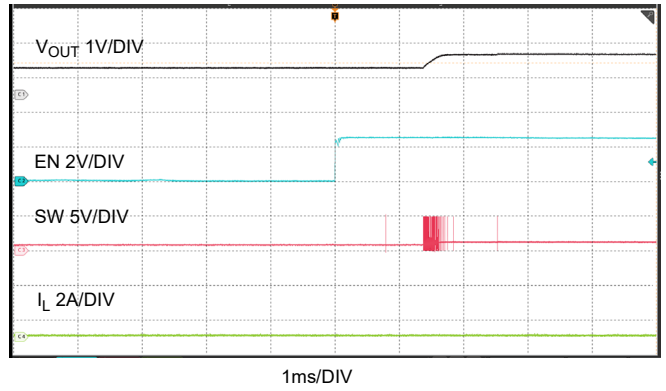

Figure 27. Pre-bias on, no load

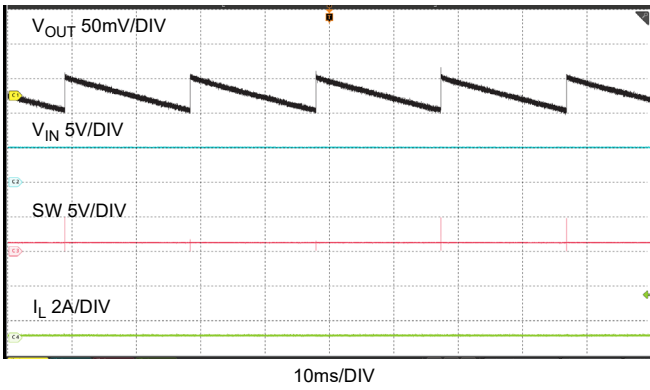

Figure 28. Steady State at 0A

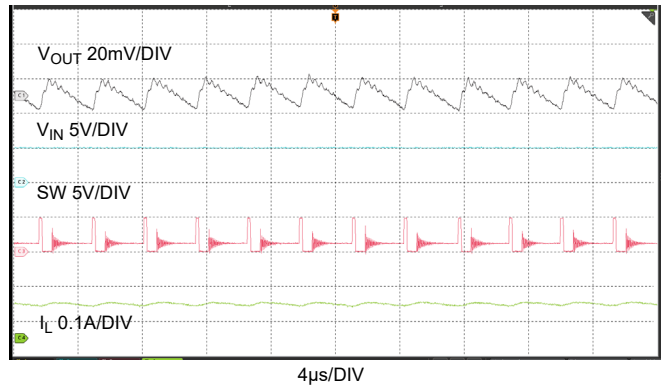

Figure 29. Steady State at 0.1A

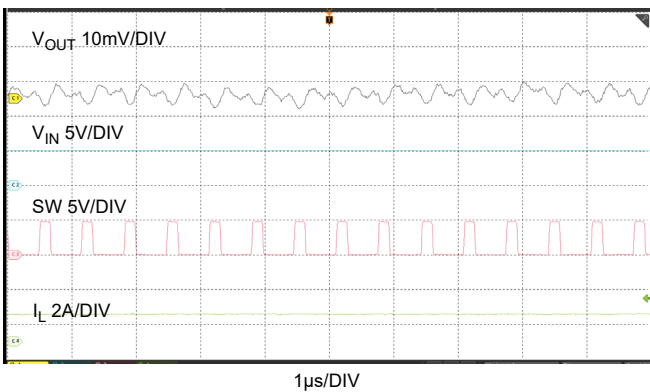

Figure 30. Steady State at 1.5A

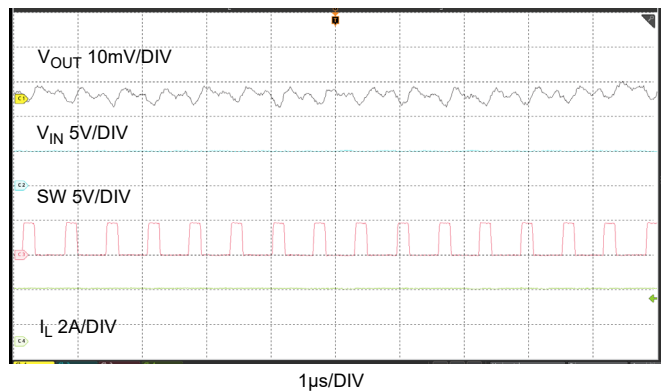

Figure 31. Steady State at 3A

$V_{IN} = 5V$, $V_{OUT} = 1.2V$, $T_A = +25^{\circ}C$. (Cont.)

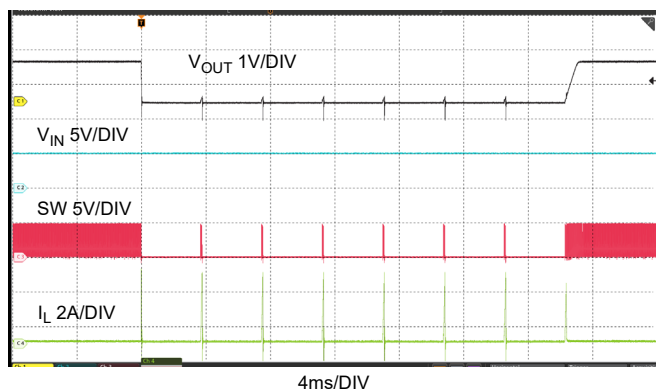

Figure 32. Hiccup with Output Short, No Load

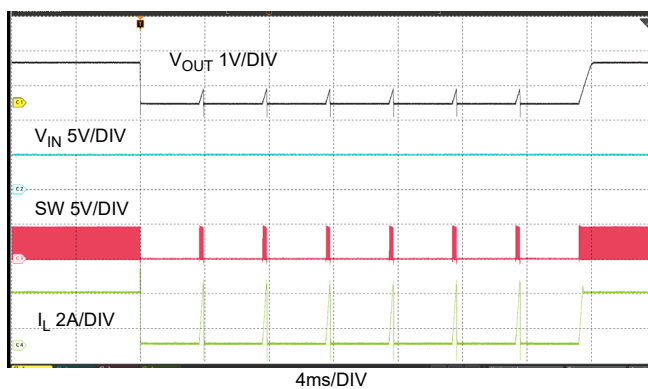

Figure 33. Hiccup with Output Short, Full Load

4. Ordering Information

Part Number	Description
RTKA808013DE0000BU	2.7V~5.5V Synchronous Buck Converter Evaluation Board

5. Revision History

Revision	Date	Description
1.00	Aug 19, 2022	Initial release

IMPORTANT NOTICE AND DISCLAIMER

RENESAS ELECTRONICS CORPORATION AND ITS SUBSIDIARIES (“RENESAS”) PROVIDES TECHNICAL SPECIFICATIONS AND RELIABILITY DATA (INCLUDING DATASHEETS), DESIGN RESOURCES (INCLUDING REFERENCE DESIGNS), APPLICATION OR OTHER DESIGN ADVICE, WEB TOOLS, SAFETY INFORMATION, AND OTHER RESOURCES “AS IS” AND WITH ALL FAULTS, AND DISCLAIMS ALL WARRANTIES, EXPRESS OR IMPLIED, INCLUDING, WITHOUT LIMITATION, ANY IMPLIED WARRANTIES OF MERCHANTABILITY, FITNESS FOR A PARTICULAR PURPOSE, OR NON-INFRINGEMENT OF THIRD PARTY INTELLECTUAL PROPERTY RIGHTS.

These resources are intended for developers skilled in the art designing with Renesas products. You are solely responsible for (1) selecting the appropriate products for your application, (2) designing, validating, and testing your application, and (3) ensuring your application meets applicable standards, and any other safety, security, or other requirements. These resources are subject to change without notice. Renesas grants you permission to use these resources only for development of an application that uses Renesas products. Other reproduction or use of these resources is strictly prohibited. No license is granted to any other Renesas intellectual property or to any third party intellectual property. Renesas disclaims responsibility for, and you will fully indemnify Renesas and its representatives against, any claims, damages, costs, losses, or liabilities arising out of your use of these resources. Renesas' products are provided only subject to Renesas' Terms and Conditions of Sale or other applicable terms agreed to in writing. No use of any Renesas resources expands or otherwise alters any applicable warranties or warranty disclaimers for these products.

(Rev.1.0 Mar 2020)

Corporate Headquarters

TOYOSU FORESIA, 3-2-24 Toyosu,
Koto-ku, Tokyo 135-0061, Japan
www.renesas.com

Contact Information

For further information on a product, technology, the most up-to-date version of a document, or your nearest sales office, please visit:
www.renesas.com/contact/

Trademarks

Renesas and the Renesas logo are trademarks of Renesas Electronics Corporation. All trademarks and registered trademarks are the property of their respective owners.