

Description

The SensorShare™ SDAWIR03 Demonstration Kit demonstrates using the IDT ZWIR4512 6LoWPAN Low-Power Wireless Module to communicate humidity, temperature, and flow sensor measurement data to the kit's 6LoWPAN-WiFi Hub, which functions as a WiFi hub, allowing a linked device to display and graph the measured data in real time. The kit's Hub can also link to an end-user's WiFi hub, which also allows any network device to display and graph the data in a web browser. The kit's Hub also permits sending the measurements to Amazon® Web Services with all the required permissions and setup of the data to be viewed worldwide. The end-user only needs an Amazon Web Service account.

The SDAWIR03 kit uses the IDT HS3001 Humidity and Temperature Sensor and the FS2012 Flow Sensor for the measurements. The sensors are mounted in a 5cm clear plastic cube that contains a ZWIR4512 Wireless Module to communicate with the Hub. The 6LoWPAN-WiFi Hub and the Sensor Cube are powered by a separate AC/DC wall mount adapter. If using only the HS3001, it can be powered from coin cell batteries.

The Hub utilizes a Raspberry PI Zero W to provide the WiFi hub function interfaced to the ZWIR4512 Wireless Module. The Hub uses the Raspbian LXDE Lightweight Desktop Environment, which is a Debian-based computer operating system for the Raspberry Pi. Many of the Hub functions are written in Python. The Hub micro-SD card is fully loaded and ready for operation.

The Sensor Cubes use the software modules provided with the IDT ZWIR4512 6LoWPAN radio module. The sensor interface is either I2C or an analog voltage. The Cube can be expanded to operate other 3.3V I2C capable sensors.

Kit Contents

- 6LoWPAN-WiFi Hub operating with a Raspberry PI Zero W
- Sensor Cube including the HS3001 Humidity Sensor, FS2012 Flow Sensor, and ZWIR4512 6LoWPAN RF Module
- Hose; USB and HDMI adapters
- 2 AC/DC Wall-Mount Adapters depending on the kit part code: SDAWIR03-AMZ01-NA for North America; SDAWIR03-AMZ01-GB for other locations

SDAWIR03 Demonstration Kit



SensorShare
By Integrated Device Technology

Features

- HS3001 Humidity and Temperature Sensor with I2C interface in the Sensor Cube
 - RH accuracy: $\pm 1.5\%$ RH typical (10% to 90% RH, 25°C)
 - Fast RH response time (typical: 6 seconds)
 - Temperature sensor accuracy: $\pm 0.2^\circ\text{C}$ (typ.) at -10 to +80 °C
- FS2012 Flow Sensor with I2C interface in the Sensor Cube
 - Gas or liquid mediums
 - Robust solid isolation technology
 - Resistant to surface contamination, vibration, pressure shock
 - No cavity to cause clogging
- License-free 868/915 MHz frequency bands
- IPv6 module addressing
- 4 channels in EU mode; 10 channels in US mode
- Hub WiFi connections: 2.4GHz
- No software to install; apply power and WiFi link to the Hub to view measurements
- The Hub can also link to a local WiFi hub to view measurements
- When linked to a local WiFi hub, the Hub can link to Amazon Web Service (AWS) and write sensor data to AWS
- All the required setup is included to allow writing data to the end-user's AWS account
- Over-the-air update (OTAU) functionality in the Hub and Sensor Cube; automatic OTAU from IDT if linked to AWS
- Multiple Cubes with sensors installed can communicate with the Hub and have results displayed
- Cubes automatically mesh if needed to complete the communication path to the Hub
- The Hub and Sensor Cube operate from a 5.0V DC and micro-USB connector; wall-mount power supply adapters are included
- Wall-mount adapters have the AC mains connection plugs commonly used worldwide or in North America
- Related datasheets are available online:
 - ZWIR4512: www.idt.com/ZWIR4512
 - FS2012: www.idt.com/FS2012
 - HS3001: www.idt.com/HS3001



Important Notes

Disclaimer

Integrated Device Technology, Inc. and its affiliated companies (herein referred to as "IDT") shall not be liable for any damages arising out of defects resulting from

- (i) delivered hardware or software
- (ii) non-observance of instructions contained in this manual and in any other documentation provided to user, or
- (iii) misuse, abuse, use under abnormal conditions, or alteration by anyone other than IDT.

TO THE EXTENT PERMITTED BY LAW, IDT HEREBY EXPRESSLY DISCLAIMS AND USER EXPRESSLY WAIVES ANY AND ALL WARRANTIES, WHETHER EXPRESS, IMPLIED, OR STATUTORY, INCLUDING, WITHOUT LIMITATION, IMPLIED WARRANTIES OF MERCHANTABILITY AND OF FITNESS FOR A PARTICULAR PURPOSE, STATUTORY WARRANTY OF NON-INFRINGEMENT, AND ANY OTHER WARRANTY THAT MAY ARISE BY REASON OF USAGE OF TRADE, CUSTOM, OR COURSE OF DEALING.

Restrictions in Use

IDT's SDAWIR03 Demonstration Kit consisting of the 6LoWPAN-WiFi Hub, Sensor Cube(s), AC/DC Wall Mount Adapters, Hose, USB and HDMI adapters, and the *IDT Demo Software*, are designed to provide a quick setup for taking Flow, RH%, and temperature measurements with the FS2012 and HS3001 only. IDT's SDAWIR03 Demonstration Kits and *IDT Demo Software* must not be used for any mission-critical applications, end-customer products, or measurement reference source.

Contents

1. Setup4

 1.1 Computer Requirements4

 1.2 Kit Connections and Power Switch4

 1.3 Kit Power-On and Operation5

 1.4 Kit Power Off6

 1.5 Setting the Wireless Frequency Band for the ZWIR45126

 1.6 Altering the Cube Function and Performing a Reset.....6

 1.7 Operating with Only the HS3001 Sensor or Only the FS2012 Sensor.....7

2. Usage Guide.....7

 2.1 The Web Browser Display.....7

 2.2 The Cube Browser Registration Display7

 2.3 The Status and Measurement Control Menu8

 2.3.1 The Status Information.....8

 2.3.2 The Measurement Control9

 2.4 Function Change Menu.....10

3. Logging onto a WiFi Network11

4. Amazon Web Services Operation13

 4.1 Setting-up an AWS Account.....13

 4.2 Opening the "AWS Configuration" Menu.....14

 4.3 Visualizing Data on AWS16

5. Data Format to AWS and AWS Data Handling.....17

6.	Hub and Cube Firmware Update	21
6.1	End-User Firmware Update	21
6.2	AWS Automatic Firmware Update	21
7.	Ordering Information.....	21
8.	Revision History.....	22

List of Figures

Figure 1.	6LoWPAN-WiFi Hub and Sensor Cube Connections	4
Figure 2.	Bottom View of Sensor Cube	4
Figure 3.	Sensor Measurement Display	5
Figure 4.	Band Selection Menu	6
Figure 5.	Flag Icon for Changing the Frequency Band	6
Figure 6.	Overview of the Web Browser Display	7
Figure 7.	Browser Registration Display Example	7
Figure 8.	Status Information	8
Figure 9.	Measurement Control Menu	9
Figure 10.	Function Change Menus	10
Figure 11.	Network Configuration Display with No Connections	11
Figure 12.	Network Configuration Display When Initiating a Connection	11
Figure 13.	Network Configuration Display during a Connection Attempt.....	12
Figure 14.	Network Configuration Display with a Valid Connection.....	12
Figure 15.	Downloading the .csv Credential File	13
Figure 16.	The <i>SDAWIR03demo.csv</i> File.....	14
Figure 17.	The AWS Configuration Display	15
Figure 18.	An Example of the “Message” Box.....	16
Figure 19.	Examples of Displaying Cube Data via AWS	16
Figure 20.	Example of Data Formatting on Kibana.....	19
Figure 21.	Cube Information Shown on the JSON Tab for “idt-esi-data” in Kibana	19
Figure 22.	Cube Information Shown on the JSON Tab for “idt-esi-reg” in Kibana	20

List of Tables

Table 1.	Status Information Menu	8
Table 2.	Measurement Control Menu Settings	9

1. Setup

1.1 Computer Requirements

Any device that can link to a WiFi hub and execute Java® script can display and graph the measured the sensor data from the SDAWIR03 Kit. This has been evaluated and confirmed for many smart phones, tablets, and PCs using one of the various internet browsers. There is no software to download or install on the computer or smart phone.

1.2 Kit Connections and Power Switch

Figure 1. 6LoWPAN-WiFi Hub and Sensor Cube Connections

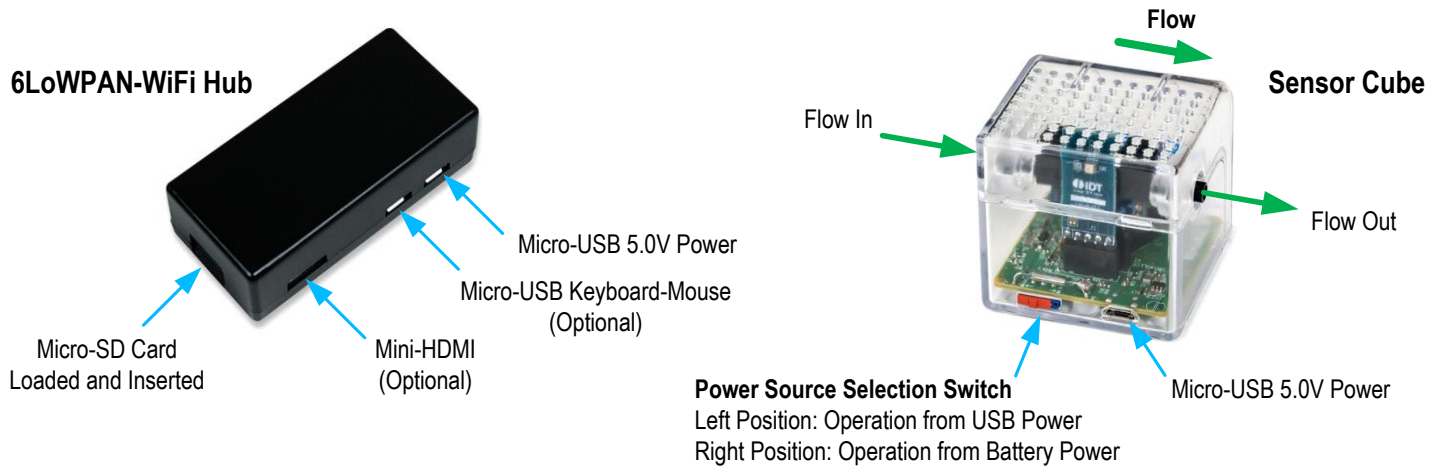
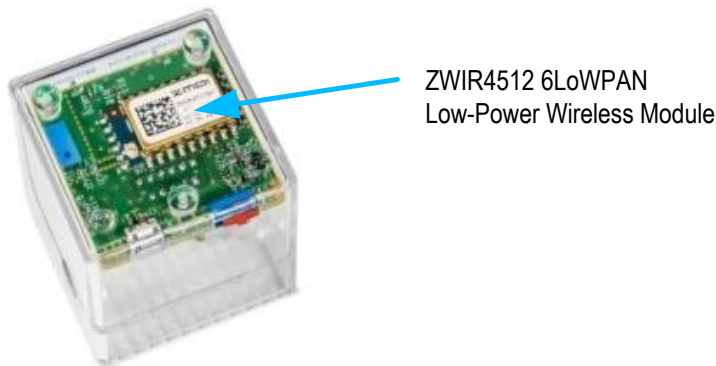

Figure 2. Bottom View of Sensor Cube



The Hub is always operated from the AC/DC Wall-Mount Adapter, which is included in this kit.

If the FS2012 Flow Sensor is included in the Sensor Cube, the Sensor Cube must operate from the AC/DC Wall-Mount Adapter. If the FS2012 is removed and only the HS3001 Humidity Temperature Sensor is used, the Sensor Cube can function using only the internal batteries or using the adapter. The internal battery holder is for two CR2032 coin cell batteries, which can support low-powered sensors, such as the HS3001. The batteries are not included in the kit.

The optional connections permit the user to operate the Raspberry PI Zero with its Linux-like operating system. These connections are not required for the Hub application. If used, the optional connections do not interfere with the Hub's functionality.

1.3 Kit Power-On and Operation

Follow these procedures for setting up the Hub and Sensor Cube:

- Set up the user's computer device (PC, smart phone with WiFi, or tablet) as needed for use with the kit.
- Power-up the Hub. The boot process will begin, which takes about 2.6 minutes.
- Next, link the user's computer device to the Hub, which is named "ISG_Demo." There is no password or other login needed.
- With the Sensor Cube's power source selection switch in the battery-powered position (see Figure 1), connect the USB power, and then switch to the USB-powered position to power-up the Sensor Cube. The blue LEDs in the Sensor Cube should begin to flash. The LED on the FS2012 will light to indicate it is powered and operating. Place the Cube near the Hub such that the LEDs on the main board of the Cube are visible.
- The two LEDs on the main circuit board indicate that a measurement is being read from the I2C devices (FS2012 and HS3001) and communication is occurring with the Hub on the 6LoWPAN wireless link.
- If more Sensor Cubes are available, they may also be powered at this time and they will also appear in the browser.
- Open the internet browser on the WiFi-linked computer device. Navigate to <http://demo.isg/>

After a few seconds needed for the automatic download of the required Java script, the screen should display the Sensor Cube's sensor information and the actual sensor measurements (see Figure 3). The internet browser might store prior information, so it might be necessary to refresh the browser to purge prior information. If the Hub has not been initialized to a wireless frequency band, the browser screen will appear as shown in section 1.5. In this case, follow the instructions in section 1.5 to properly set the wireless frequency band.

Figure 3. Sensor Measurement Display

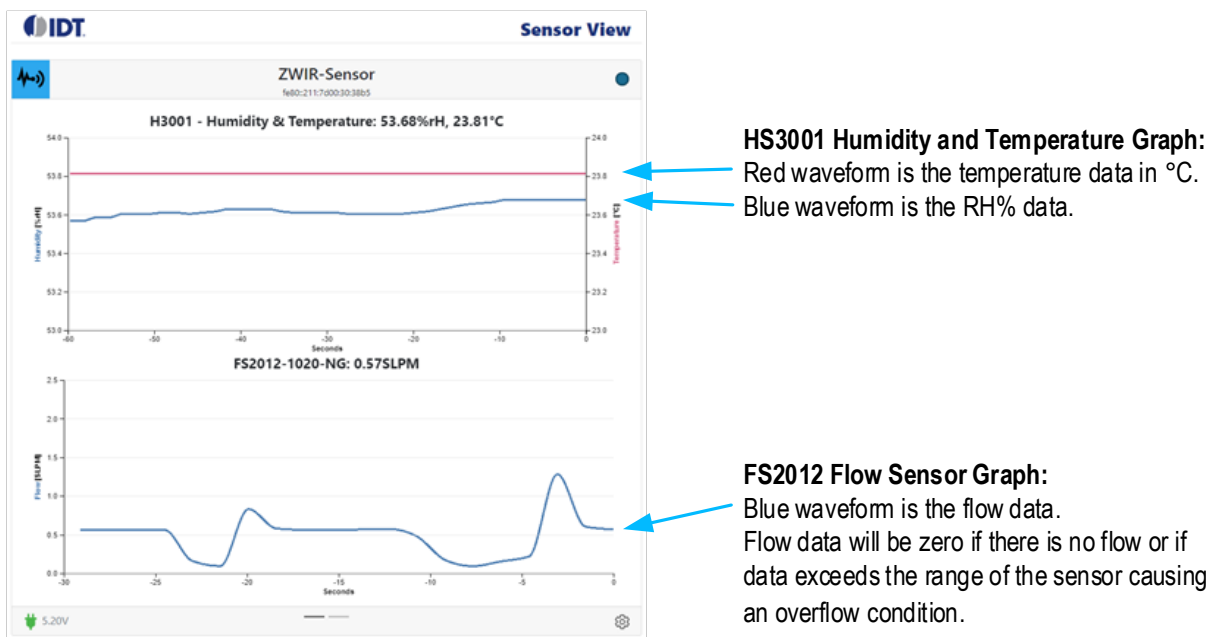

The measurement display has the following features:

- The horizontal time axis can be changed from 30 seconds to 600 seconds with the user's mouse wheel.
- The vertical axes are auto-scaled.
- As new measurements occur, the previous data points scroll to the left and then are off the graph.
- The current digital value is shown above each graph.
- If the Sensor Cube is not operating or not linked to the Hub, only the top line with the IDT logo and Sensor Demo appears.

1.4 Kit Power Off

There is no special shutdown or power off sequence needed. Just remove power from the Hub and Sensor Cube.

1.5 Setting the Wireless Frequency Band for the ZWIR4512

On the first usage of the Demonstration Kit, the user will be requested to select the frequency band to use as shown in Figure 4.

Figure 4. Band Selection Menu

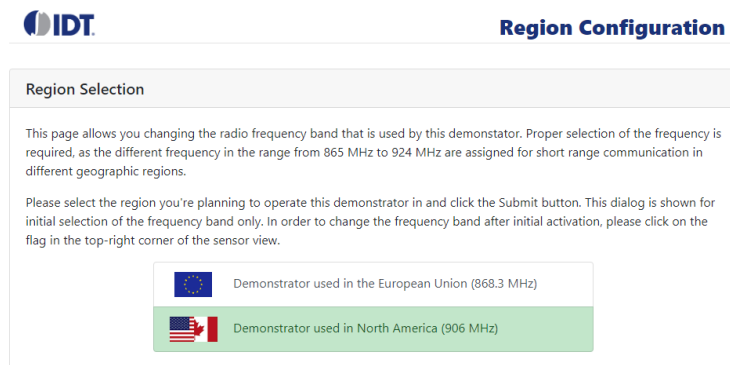

Select the region in the menu: “North America” for the higher frequency wireless band or “Europe” for the lower frequency band. Click on the box for the correct frequency. This will highlight the box, and the change will take effect in about 60 seconds. Depending on the browser, the browser may need to be refreshed.

The operating Cube will find the communication link is broken and will then search both wireless bands to determine if the Cube can link to the Hub. The Cube follows the Hub’s selected band. The Cube does this wireless band search every time the Cube is powered up.

The Hub retains the previously set wireless band settings when powered up.

After the initial selection, the band select function is accessed by placing the web browser cursor on the top banner of the web page in the region where the IDT logo and the display title are shown. This will cause an additional line to appear as shown in Figure 5.

Figure 5. Flag Icon for Changing the Frequency Band



The upper-right corner shows the wireless band being used. This icon can be clicked to change the wireless band. The menu will take several seconds to load, and the browser will then show the band selection information and menu options as shown in Figure 4. The delay is because the Python interpreter must enable in the Raspberry Pi and the browser information must be received from the Hub.

1.6 Altering the Cube Function and Performing a Reset

There is a reed switch located in front of the battery holder on the opposite side of the Sensor Cube relative to the switch and USB power connector. This reed switch can be activated with a magnet.

- Activation for less than 3 seconds resets the Sensor Cube.
- Activation for more than 3 seconds sets the Sensor Cube to the Always-on Mode, even if the battery is used. The LEDs show the activation status. For the first 3 seconds, both LEDs are always on; then one of the LEDs starts flashing rapidly, indicating that Always-on Mode is active.
- To exit the Always-on Mode, reset the Sensor Cube or cycle the power.

1.7 Operating with Only the HS3001 Sensor or Only the FS2012 Sensor

When the Sensor Cube is powered, the I2C addresses are scanned for the sensors that are connected. The kit is supplied with two sensors, but either one can be removed. In this case, the Sensor Cube will only report the actual sensor installed.

The FS2012 Flow Sensor power requirements are higher, so it is not intended for battery operation. The HS3001 Humidity Sensor is fully functional using only battery power. The Sensor Cube requires two CR2032 3V lithium coin cell batteries.

2. Usage Guide

2.1 The Web Browser Display

Figure 6. Overview of the Web Browser Display

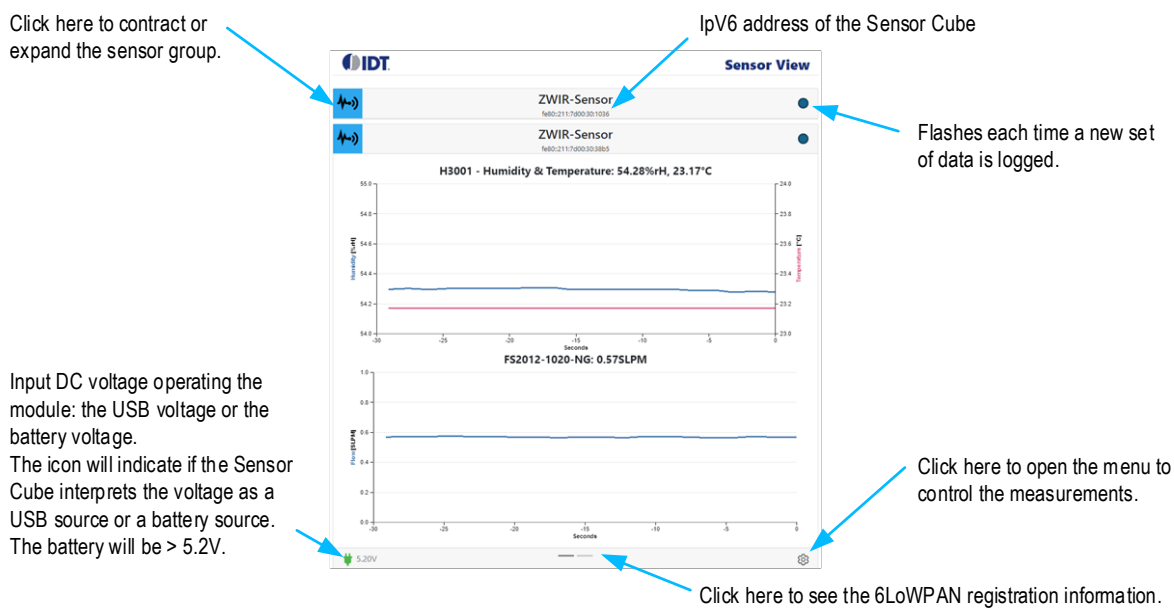

2.2 The Cube Browser Registration Display

The browser logs the date and time when the Sensor Cube is linked to the Hub. This example shows the registration and the response after the measurement parameters for a sensor were changed. This history is reset when the browser is terminated.

Figure 7. Browser Registration Display Example

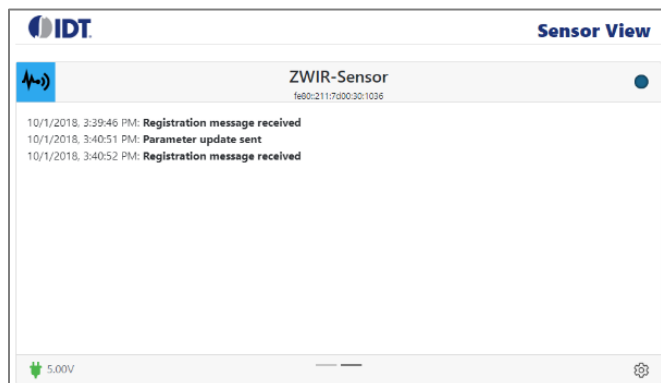

2.3 The Status and Measurement Control Menu

The status and control menu can be opened in the browser. This provides some read-only information and permits controlling the measurements and display information. These measurement commands are wireless inputs to the Sensor Cube.

2.3.1 The Status Information

The first portion of the menu is read only. This area shows the information about the specific Cube shown in the IPv6 address on the top of the display.

Figure 8. Status Information



Table 1. Status Information Menu

Menu Item	Description
Firmware Version	The version number of the Cube firmware.
Hops to Sensor	The number of mesh hops from the Hub to the Sensor (Cube). In this example, this is a direct Hub to Cube connection.
Last hop RSSI	The RSSI (Received Signal Strength Input) in dBm at the input to the Sensor (Cube) radio receiver. The intermediate meshed connections are not shown. The lowest level that could be indicated is -110dBm, and this would be a marginal connection.
Hops to the Hub	The number of mesh hops from the Sensor (Cube) to the Hub. In this example, this is a direct Cube to Hub connection.
Last hop RSSI	The RSSI (Received Signal Strength Input) in dBm at the input to the Hub radio receiver. The intermediate meshed connections are not shown. The lowest level that could be indicated is -110dBm, and this would be a marginal connection.
Device Name	Name assigned to the type of device in the link.

2.3.2 The Measurement Control

There are two sets of control information: one for USB power and one for battery power shown in sequence in the control menu (see Figure 9). The control information allows adjusting measurement parameters to reduce power consumption; for example, only sending pertinent information.

Figure 9. Measurement Control Menu

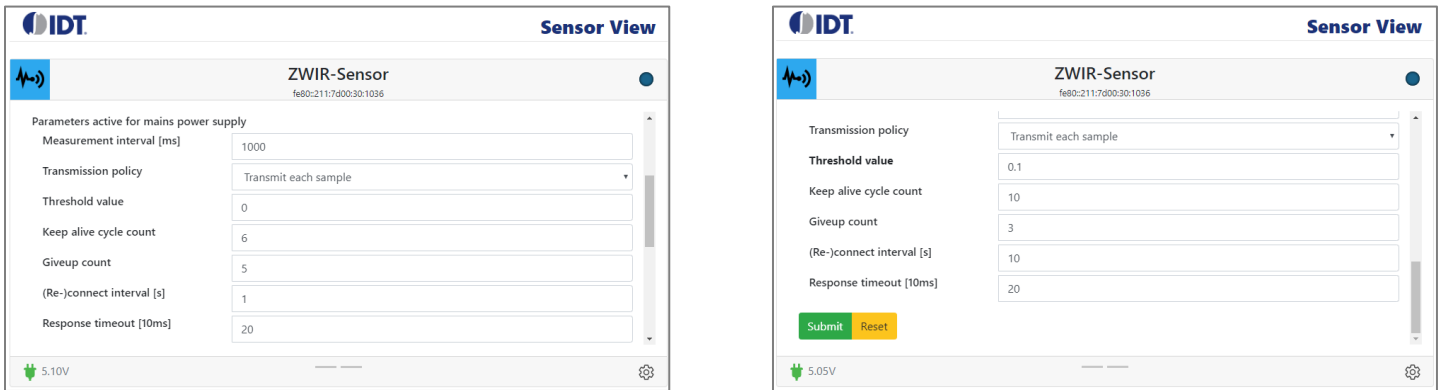

Use the scroll bar on the right of the menu to view all the features. The buttons at the bottom of the menu can be used to send new settings or reset settings to the previous conditions. If the settings are changed, the new settings are stored in the Sensor Cube but are not stored in the browser. Table 2 gives the descriptions for the menu items. Items that are R/W can be changed by the user.

For the Sensor Cubes with two sensors, the following settings have no practical meaning and are ignored:

- Transmission Policy: Transmit on relative change
- Transmission Policy: Transmit on absolute change
- Transmission Policy: Transmit on above threshold
- Transmission Policy: Transmit on below threshold
- Threshold Value

For Sensor Cubes with single sensors and two or more parameters being measured, this applies to the first reading only.

Table 2. Measurement Control Menu Settings

Note: See important notes at the end of the table.

Menu Item	Options	Description	R/W
Measurements interval (ms)	–	The time in ms between the triggers for new readings.	R/W
Transmission policy	Transmit each sample	All measurements are transmitted.	R/W
	Transmit on relative change	If $(\text{abs}((P - M) / P) > T)$, then send. ^[a]	R/W
	Transmit on absolute change	If $(\text{abs}(P - M) > T)$ then send. ^[a]	R/W
	Transmit on above threshold	Measurements continue at the measurement interval but are only sent when the results are above the threshold value.	R/W
	Transmit on below threshold	Measurements continue at the measurement interval but are only sent when the results are below the threshold value.	R/W
Threshold value	–	Value to be used as the threshold for the “Transmission Policy” setting.	R/W

Menu Item	Options	Description	R/W
Keep alive cycle count	–	When transmission policy is NOT “Transmit each sample,” this value specifies the maximum number of measurement cycles allowed before a measurement is transmitted by the Sensor Cube. This is independent of other policy rules.	R/W
Give-up count	–	The number of consecutive communication cycle failures that can occur before the link to the Hub is considered broken.	R/W
(Re-)connect interval (s)	–	When the linkage to the Hub is lost, this is the time in seconds that Sensor Cube will remain idle between attempts to link to the Hub.	R/W
Response timeout (10ms)	–	The Sensor Cube sends information to the Hub and waits this amount of time in 10ms increments to receive an acknowledgment back from the Hub before deeming this a failed communication cycle.	R/W

[a] P is the last value that has been transmitted successfully to the Hub; M is the current measurement result; and T is the value configured in “Threshold Value.”

2.4 Function Change Menu

Added functions are accessed by placing the web browser cursor on the top banner of the web page in the region where the IDT logo and the display title are shown. This will cause an additional line to appear. Point and click on the desired option and allow a few seconds for the menu to load.

- “Sensor View” drop-down menu: Shows the connected sensor results; see sections 1 and 2 above.
- “Network Configuration” drop-down menu: Permits connecting the Hub to a local WiFi network. See section 3.
- “AWS Configuration” drop-down menu: Permits setting up the interface to Amazon Web Services sensor measurement database collection options.
- Region flag icon: Permits changing the 6LoWPAN radio connection. See section 1.5.

Figure 10. Function Change Menus



3. Logging onto a WiFi Network

The Hub will load the “Network Configuration” screen and will then try to log onto a prior connection if one has been previously achieved. The menu will also load any available WiFi connections at 2.4GHz, and the networks SSID will be shown. The WiFi connection will be setup with WiFi Protected Access (WPA). The connection is setup with Dynamic Host Configuration Protocol (DHCP), which is a client/server protocol that automatically provides an Internet Protocol (IP) host with its IP address and other related configuration information such as the subnet mask and default gateway.

If no connections have been set, the browser screen will look like Figure 11.

Figure 11. Network Configuration Display with No Connections

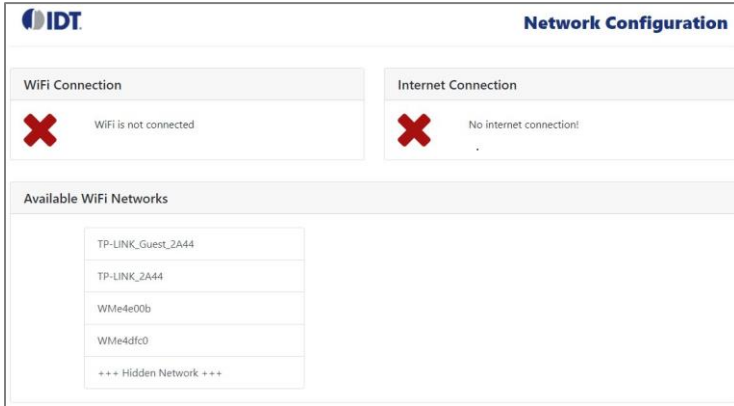

To make a connection, click on the desired SSID name. The screen will indicate the status of that SSID signal's quality and the WiFi channel to be used, and it permits entering the password.

Figure 12. Network Configuration Display When Initiating a Connection

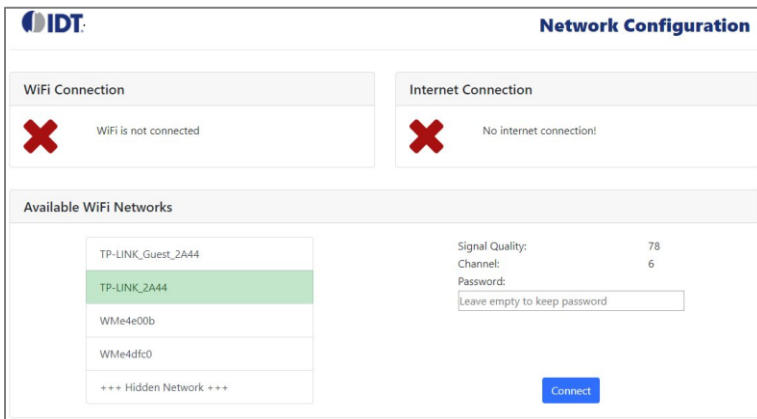

Key in the password, and click on the “Connect” box. The display will then show in the “WiFi Connection” and “Internet Connection” box that a connection attempt is being made as shown in Figure 13.

Figure 13. Network Configuration Display during a Connection Attempt

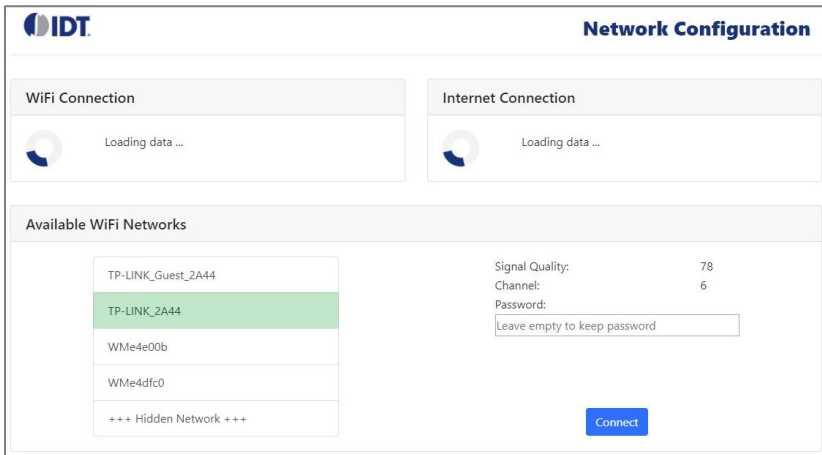

When a connection is achieved, the screen will then display the connection information as shown in Figure 14:

- The WiFi connection box is the local IP address that the Hub is using to connect to the local network. This is important to know for best use of the Hub. This will change when future connections are made or the Hub is restarted.

IMPORTANT: For all further use of the Hub functions, close the browser session where the Hub was used as a WiFi hub.

- Re-open the browser, key in this local IP address, and operate the Hub as a connection to the local WiFi. For this example, the user would key in 192.168.0.21 into the browser. The “Internet Connection” box will show the internet address connection that must be active for the AWS data logging options.

Figure 14. Network Configuration Display with a Valid Connection

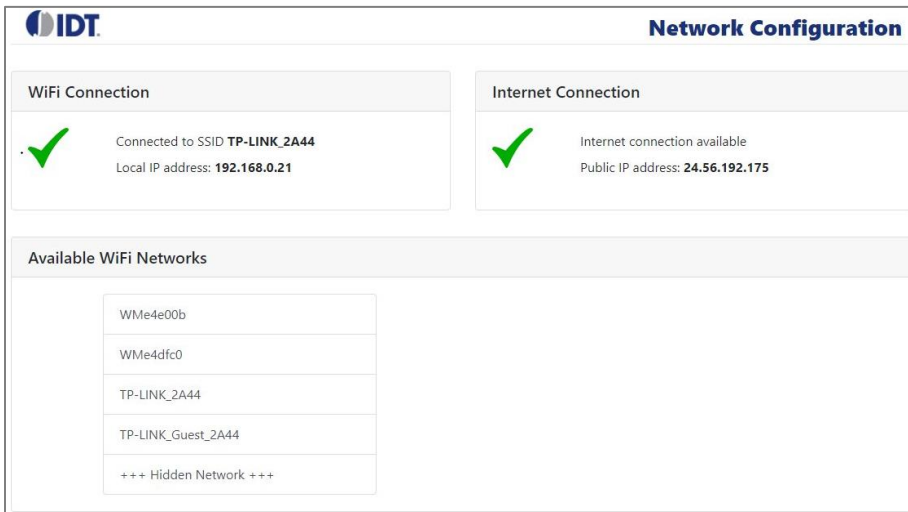

4. Amazon Web Services Operation

This section describes how the Hub can pass the measurement data from the Cubes to the AWS database. This process is completely automated by the Cube, but this does require the user to have an AWS account. The examples here use a generalized IDT account for illustration, and this is active. Remember this account is open to all users of this SDAWIR03 kit; therefore every user should open their own account as soon as possible.

IMPORTANT: IDT reserves the right to modify and/or clear this demonstration account at any time.

4.1 Setting-up an AWS Account

To open an AWS account, open <https://aws.amazon.com/> in the web browser, and then choose “Create an AWS Account.” This might be unavailable in the user’s browser if the user has not previously signed into the AWS Management Console. In that case, choose Sign into a different account, and then choose “Create a new AWS account.”

Follow these instructions for setting up the required admin account that will provide the CSV credential file.

1. Create a user account by entering contact details, credit card information, and all other required input.
2. Log on to the AWS Management Console.
3. Click on “Services” in the top menu bar and enter “IAM” in the search box that appears at the top of the menu. Click on “IAM” below or simply press “Enter.”
4. Click on “Users” on the menu on the left side.
5. Click on the “Add user” button at the top of the page.
6. Enter a user name, e.g., “admin,” and select “Programmatic access” in the “Access type” selector. Click “Next: Permissions.”
7. Select “Attach existing policies directly” and enable the checkmark on the policy name “Administrator access.” Ignore the “Set permissions boundary” options below and click on “Next: Review”
8. Review and click on “Create User.”
9. This will result in a “Success...” message. On this page, click the “Download .csv” button to download the credential file. This file is later used for the first step of the web frontend configuration.

IMPORTANT: This is the only opportunity to download the credentials file. If this page is closed or exited, there is no option to get the file downloaded later. In this case, a new user account must be created.

Figure 15. Downloading the .csv Credential File

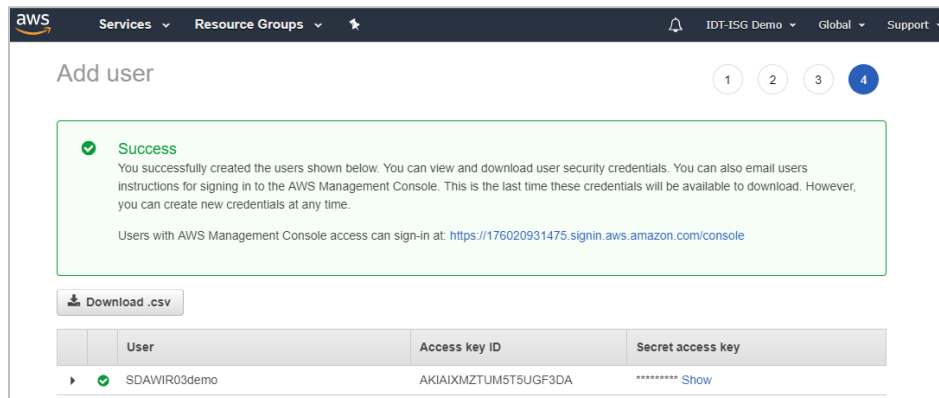

For the procedures in this manual the file name is *SDAWIR03demo*, and the *.csv* file appears as shown in Figure 16. This *.csv* file is located on the IDT website with this manual.

Figure 16. The *SDAWIR03demo.csv* File

	A	B	C	D	E	F
1	User name	Password	Access key ID	Secret access key	Console login link	
2	SDAWIR03demo		AKIAIXMZTUM5T5UGF3DA	zfbSa+5iISq84RwhVOEkAPupKY5LCEL8Fs2lh5NS	https://176020931475.signin.aws.amazon.com/console	
3						

4.2 Opening the “AWS Configuration” Menu

In the web browser display, access the function change menu as described in section 2.4. Click on “AWS Configuration,” which starts a process to log the Hub onto the user’s AWS account and setup parameters so the data from the sensors in the Cubes can be viewed and displayed graphically.

IMPORTANT: The Hub must be logged onto the local WiFi that has internet access. Do not attempt this when the Hub is operating in the WiFi Hub Mode. The operations will timeout.

The first step is to see if the AWS credentials for the account are valid and will log on. Figure 17 shows a successful example with the green checkmark. The “Change” button permits selecting a different credential or log in file. These are normally *.csv* files issued by AWS when setting up an account (see section 4.1).

If an AWS credentials file has previously been selected, that will automatically be tried. Click on “Change” to select a new account. A green checkmark will appear when the credential is accepted.

The “Thing Configuration” section will use the prior name or permit entering a new name. In this example, “IDT_SDAWIR03_Demo” was entered.

The AWS “Elasticsearch Configuration” will use the prior name or if a new AWS credential is used, then a new configuration will automatically generate. As this generates, the “Messages” box will display the many AWS actions that are being completed.

The “AWS Status” can be changed. For automatic startup of the Hub, the “Start” options and then “Autostart Enabled” should be selected so the menu shows “Running, Autostart enabled.”

The “Kibana” box will show the status of the AWS Kibana data handling.

Figure 17. The AWS Configuration Display

AWS Configuration

AWS Credentials

 **Connected as SDAWIR03demo @ 176020931475**

Thing Configuration

 **Device is connected as IDT_SDAWIR03_Demo**

Elasticsearch Configuration

 **generated-new @ search-generated-new-an7mrt5mxxlbhg65ztxhikffy.us-west-2.es.amazonaws.com**

AWS Service Status: Stopped, Autostart enabled

Kibana

 **Kibana provides a toolbox for visualization of data stored in ElasticSearch.**

This instance of Kibana is configured properly. Please use the link below to generate gauge visualizations for demonstration purposes. Once generated, visualizations are listed in the Kibana Visualizations page.

9775711 sensor samples from 106 transmitters found in ElasticSearch.

Messages

```

Obtaining own MAC address ... b8:27:eb:da:85:22
Checking if other things have been registered for address b8:27:eb:da:85:22 before ... YES
Removing certificates ... SUCCESS
Deleting thing IDTWA02 ... SUCCESS
Creating thing 'IDT_SDAWIR03_Demo' ... SUCCESS
Creating certificates for 'IDT_SDAWIR03_Demo' ... SUCCESS
Storing keys and certificate locally ... SUCCESS
Creating thing policy ... EXISTED
Attaching policy to principal ... SUCCESS
    
```

4.3 Visualizing Data on AWS

To setup AWS so the data can be easily viewed, click on the “Create Visualization” button in the “Kibana” box. This will control the process and show messages in the “Message” box as the visualization is created for all the sensor transmitters. Figure 18 shows an example of the message box when the process completes.

Figure 18. An Example of the “Message” Box

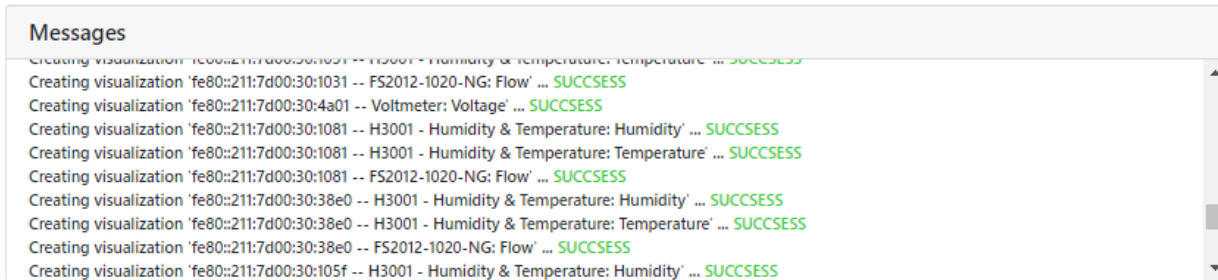

Further usage of AWS services and displaying data information will be found on the AWS support web page.

This is an example display of four Cubes -- two operating in IDT’s Penang, Malaysia facility and two operating in the IDT’s headquarters in San Jose, CA, USA.

Figure 19. Examples of Displaying Cube Data via AWS

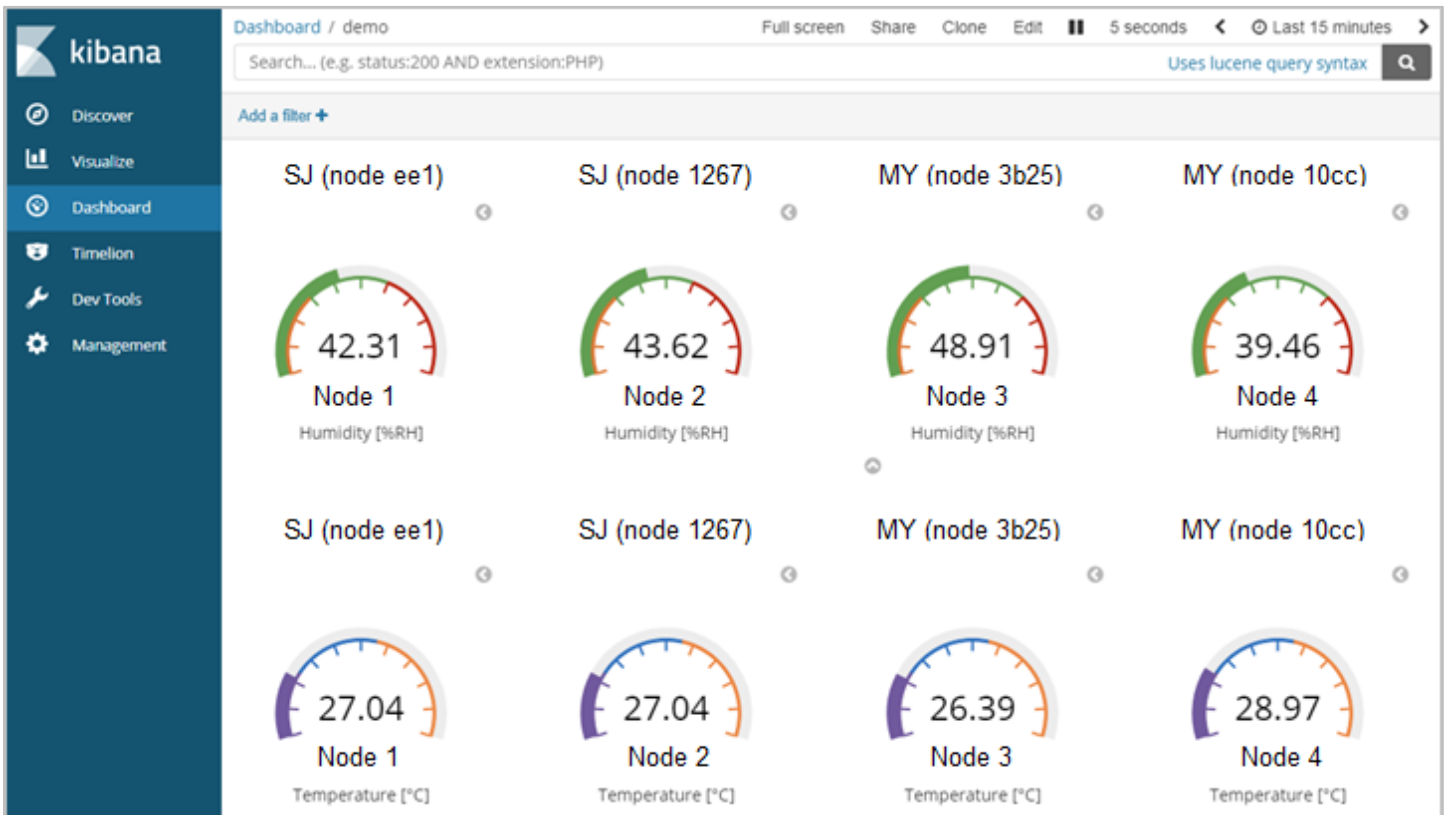

5. Data Format to AWS and AWS Data Handling

The Hub sends data to AWS approximately every 5 seconds. The data sent is a single JSON document that includes information for all attached sensors for which data has been received during the past 30 seconds.

Note that this specification uses parentheses to indicate optional data. Usually square brackets are used for this purpose, but to avoid confusion with JSON array delimiters, this notation uses parentheses.

The data is sent to MQTT topic `IDT6lowpan/<HUB_NAME>/SensorData` and is formatted as specified below:

The root object contains CUBE_DATA objects for each cube that has been sending during the past 30 seconds:

```
{
  CUBE_IPV6_ADDR: CUBE_DATA
  (, ...)
  (, CUBE_IPV6_ADDR: CUBE_DATA)
}
```

CUBE_IPV6_ADDR is the lower case short representation of the sending Cubes IPv6 address

CUBE_DATA is an object as described below:

```
{
  "Name": STRING,
  "HopsToHub": NUMBER,
  "RSSItoHub": NUMBER,
  "HopsToSensor": NUMBER,
  "RSSItoSensor": NUMBER,
  SENSOR_NAME: SENSOR_DATA
  (, SENSOR_NAME: SENSOR_DATA)
  (, SENSOR_NAME: SENSOR_DATA)
}
```

SENSOR_NAME is a string identifying a sensor type

SENSOR_DATA is an object:

```
{
  MEASURAND: MEASURAND_DATA
  (, ...)
  (, MEASURAND: MEASURAND_DATA)
}
```

MEASURAND is a string naming the measured variable

MEASURAND_DATA is an object:

```
{
  "data": NUMBER,
  "unit": STRING
}
```

```

{
  "fe80::211:7d00:30:1036": {
    "Name": "ZWIR-Sensor",
    "HopsToHub": 0,
    "RSSIToHub": -41,
    "HopsToSensor": 0,
    "RSSIToSensor": -44,
    "H3001 - Humidity & Temperature": {
      "Humidity": {
        "data": 84.038330078125,
        "unit": "%rH"
      },
      "Temperature": {
        "data": 18.65592384338379,
        "unit": "°C"
      }
    }
  },
  "fe80::211:7d00:30:38b5": {
    "Name": "ZWIR-Sensor",
    "HopsToHub": 0,
    "RSSIToHub": -47,
    "HopsToSensor": 0,
    "RSSIToSensor": -50
    "H3001 - Humidity & Temperature": {
      "Humidity": {
        "data": 53.067203521728516,
        "unit": "%rH"
      },
      "Temperature": {
        "data": 20.589635848999023,
        "unit": "°C"
      }
    }
  },
  "FS2012-1020-NG": {
    "Flow": {
      "data": 0.6079999804496765,
      "unit": "SLPM"
    }
  },
}

```

The data received is separated into smaller pieces (per-cube documents) and enhanced with information (the hub from which data this sample has been received and the receive timestamp) before being stored in ElasticSearch. The data format can be seen by looking at the discover page of Kibana as shown in the example given in Figure 20.

Open one of the items in the “Time” column and click on the JSON tab as shown in Figure 21. Everything in the curly brackets after the “_source” item is the result of extracting a single Cube’s information, enhancing it as described above.

Figure 20. Example of Data Formatting on Kibana

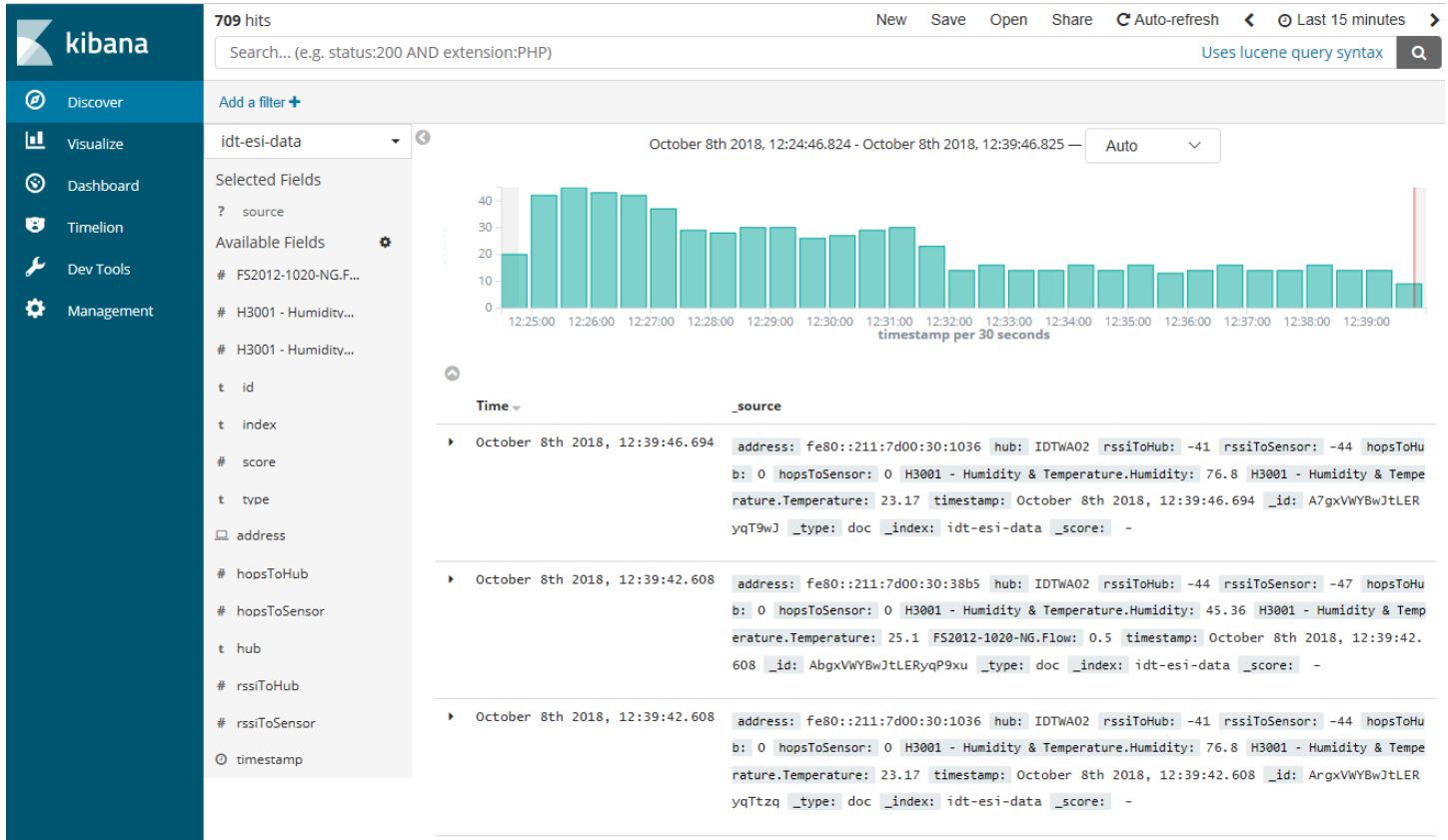

Figure 21. Cube Information Shown on the JSON Tab for “idt-esi-data” in Kibana



There is a second type of packet that is transmitted to AWS, which includes the Cube's self-description and is sent only once after registration. In the screen shown in Figure 20, on the menu item "idt-esi-data," pull down and select the other option "idt-esi-reg." In the "_source" column, expand the item and select the JSON option.

Figure 22. Cube Information Shown on the JSON Tab for "idt-esi-reg" in Kibana

```

1  {
2  "_index": "idt-esi-reg",
3  "_type": "doc",
4  "_id": "fe80::211:7d00:30:4978",
5  "_version": 7,
6  "_score": null,
7  "_source": {
8  "libVersion": [
9  0,
10 0,
11 8967
12 ],
13 "sensors": [
14 {
15 "name": "Voltmeter",
16 "parameters": [
17 {
18 "upperBound": 3500,
19 "dataType": 4,
20 "lowerBound": null,
21 "measurand": "Voltage",
22 "unit": "mV"
23 }
24 ],
25 "type": 0
26 }
27 ],
28 "hopsToHub": 0,
29 "hopsToSensor": 0,
30 "rssiToSensor": -84,
31 "address": "fe80::211:7d00:30:4978",
32 "fwVersion": [
33 1,
34 37,
35 0
36 ],
37 "rssiToHub": -87,
38 "conf": {
39 "name": "ZWIR-Sensor",
40 "mains": {
41 "conInterval": 1,
42 "measInterval": 500,
43 "giveup": 5,
44 "threshold": 0,
45 "keepAlive": 5,
46 "policy": 0,
47 "respTimeout": 20
48 },
49 "bat": {
50 "conInterval": 10,
51 "measInterval": 2000,
52 "giveup": 3,
53 "threshold": 0.10000000149011612,
54 "keepAlive": 10,
55 "policy": 0,
56 "respTimeout": 20
57 }
58 },
59 "msgType": "reg",
60 "timestamp": 1538753018210,
61 "source": "fe80::211:7d00:30:4978"
62 },
63 "sort": [
64 1538753018210
65 ]
66 }

```

6. Hub and Cube Firmware Update

The kit is designed to permit Over-The-Air-Updates (OTAU) using one of two methods. The update writes the new version to the device and then verifies the new version that was written. If all is verified, the new version is enabled. No specific end-user action is required. When doing the update, the two LEDs on the Cube will flash very rapidly, signifying the transmission and verification of the new firmware.

The update process will take several minutes. Normal Hub and Cube function will continue normally during the update process. The update process assumes a background function.

6.1 End-User Firmware Update

IDT might provide updates to the Hub and Cube in the future. The update will be available on the IDT web site (see the last page) and will be an .exe file that is executed from a Windows®-based PC to perform the update.

The normal procedure will be to use WiFi to link to the Hub and have the Hub linked to the Sensor Cubes. The Sensor Cubes should be on USB power for this procedure. Execute the .exe. Then all the updates will be performed automatically. No wired connections are needed to the Hub or Cubes.

6.2 AWS Automatic Firmware Update

If the Hub and one or more Cubes are connected to AWS, they will all be automatically updated. This update process will take several times longer than the user firmware update time needed for the procedure described in section 6.1. If there are meshed Cubes, the update may take hours.

7. Ordering Information

Orderable Part Number	Description
SDAWIR03-AMZ01-NA	The SDAWIR03 Demonstration Kit for North America, including the 6LoWPAN-WiFi Hub, Sensor Cube with HS3001 Sensor Module, FS2012 Flow Sensor, and ZWIR4512 Wireless Module, two AC/DC Wall Adapters with North American Plugs
SDAWIR03-AMZ01-GB	The SDAWIR03 Demonstration Kit for other regions, including the 6LoWPAN-WiFi Hub, Sensor Cube with HS3001 Sensor Module, FS2012 Flow Sensor, and ZWIR4512 Wireless Module, two AC/DC Wall Adapters with common world plug options
SDAWIR03-CUBE-01	The Sensor Cube with an HS3001 Humidity Sensor, which can interface with other Cubes and the Hub in the SDAWIR03 Demonstration Kit

8. Revision History

Revision Date	Description of Change
November 5, 2018	Changed "Amazon World Services" to "Amazon Web Services"
October 22, 2018	Initial release.

IMPORTANT NOTICE AND DISCLAIMER

RENESAS ELECTRONICS CORPORATION AND ITS SUBSIDIARIES (“RENESAS”) PROVIDES TECHNICAL SPECIFICATIONS AND RELIABILITY DATA (INCLUDING DATASHEETS), DESIGN RESOURCES (INCLUDING REFERENCE DESIGNS), APPLICATION OR OTHER DESIGN ADVICE, WEB TOOLS, SAFETY INFORMATION, AND OTHER RESOURCES “AS IS” AND WITH ALL FAULTS, AND DISCLAIMS ALL WARRANTIES, EXPRESS OR IMPLIED, INCLUDING, WITHOUT LIMITATION, ANY IMPLIED WARRANTIES OF MERCHANTABILITY, FITNESS FOR A PARTICULAR PURPOSE, OR NON-INFRINGEMENT OF THIRD-PARTY INTELLECTUAL PROPERTY RIGHTS.

These resources are intended for developers who are designing with Renesas products. You are solely responsible for (1) selecting the appropriate products for your application, (2) designing, validating, and testing your application, and (3) ensuring your application meets applicable standards, and any other safety, security, or other requirements. These resources are subject to change without notice. Renesas grants you permission to use these resources only to develop an application that uses Renesas products. Other reproduction or use of these resources is strictly prohibited. No license is granted to any other Renesas intellectual property or to any third-party intellectual property. Renesas disclaims responsibility for, and you will fully indemnify Renesas and its representatives against, any claims, damages, costs, losses, or liabilities arising from your use of these resources. Renesas' products are provided only subject to Renesas' Terms and Conditions of Sale or other applicable terms agreed to in writing. No use of any Renesas resources expands or otherwise alters any applicable warranties or warranty disclaimers for these products.

(Disclaimer Rev.1.01 Jan 2024)

Corporate Headquarters

TOYOSU FORESIA, 3-2-24 Toyosu,
Koto-ku, Tokyo 135-0061, Japan
www.renesas.com

Trademarks

Renesas and the Renesas logo are trademarks of Renesas Electronics Corporation. All trademarks and registered trademarks are the property of their respective owners.

Contact Information

For further information on a product, technology, the most up-to-date version of a document, or your nearest sales office, please visit www.renesas.com/contact-us/.