

User Manual

DA14585/DA14586 Getting Started Guide with the Basic Development Kit

UM-B-048

Abstract

This guide is intended to help customers setup the hardware development environment, install required software, download, and run an example application on the DA14585/586 Basic development Kit development platform.

DA14585/DA14586 Getting Started Guide with the Basic Development Kit
Contents

Abstract	1
Contents	2
Figures	3
Tables	3
1 Terms and Definitions	4
2 Prerequisites	4
3 Introduction	5
3.1 Kit Content	5
4 The DA14585/586 Hardware	6
4.1 The Basic Kit board.....	6
4.2 Configuring the Basic Kit Board by Jumper Settings	6
4.3 Board Layout.....	8
4.4 Connecting the Basic Kit to the host PC	9
5 DA14585/586 Software Installation	10
5.1 Requirements of the Development PC	10
5.2 Driver Installation	10
5.3 Configuring the Serial Port for UART	11
5.3.1 Using Serial Port.....	11
5.4 Troubleshooting	12
6 Software Development Tools	12
6.1 SmartSnippets™ Installation.....	13
6.2 KEIL Installation	15
7 Build a DA14585/586 Application	16
7.1 The Blinky Peripheral Example Application	16
7.2 The Barebone BLE Example Application.....	21
7.3 Troubleshooting	24
7.4 What Next ?	24
8 Appendices	25
8.1 Appendix A: Using the Basic Development Kit	25
8.2 Appendix B: Latency Timer of the FTDI cable	25
8.3 Appendix C: Power Management: measuring current	26
9 Revision history	28
10 Status definitions	Error! Bookmark not defined.
11 Disclaimer	Error! Bookmark not defined.
12 RoHS Compliance	Error! Bookmark not defined.

DA14585/DA14586 Getting Started Guide with the Basic Development Kit

Figures

Figure 1: The DA14585/586 Basic Kit 6

Figure 2: The DA14585/586 Basic Kit Jumper Setting 6

Figure 3: Jumper 4 Layout 7

Figure 4: Data direction of UART within J4 7

Figure 5: DA14585/586 Boot from external SPI memory 8

Figure 6: DA14585/586 Basic Board layout 8

Figure 7: Windows Driver Installation 10

Figure 8: Device Manager Port 11

Figure 9: Start Tera Term 11

Figure 10: Setting Up the Port and Testing Connectivity via Tera Term 12

Figure 11: SmartSnippets Studio Install Link 13

Figure 12: Automatically Install J-Link 14

Figure 13: Select SmartSnippets™ Studio Install Directory 14

Figure 14: Keil Lite version 15

Figure 15: CMSIS Package Installation 15

Figure 16: CMSIS Package Installation Successful 16

Figure 17: Blinky Project directory 17

Figure 18: Blinky Project Keil Workspace 17

Figure 19: Blinky Project Options 18

Figure 20: Blinky Project Scatter File 18

Figure 21: Blinky Project: Debug Option 19

Figure 22: Blinky Project: Jlink setup 19

Figure 23: Blinky Project: Project Building 20

Figure 24: Blinky Project: Start Debug Session 20

Figure 25: Keil Lite Pop Up Window 20

Figure 26: Blinky Project: Code Execution 21

Figure 27: Blinky Project: Blinky message on COM28 terminal 21

Figure 28: Barebone BLE Project directory 22

Figure 29: Barebone BLE: KEIL Project Layout 22

Figure 30: Barebone BLE: Interacting with BLE Application 23

Figure 31: Hardware Settings for Basic Development Kit 25

Figure 32: FTDI Latency Timer 25

Figure 33: Setup of DA14585 Basic Development Kit during power measurement 26

Figure 34: Setup of DA14586 Basic Development Kit during power measurement 26

Tables

Table 1: Parameters for Connecting to UART 12

Table 2: Blinky Example UART and LED Jumper Configuration 24

Table 3: Blinky Example SWD Debugger Jumper Configuration 24

Table 4: Revision history **Error! Bookmark not defined.**

Table 5: Status Definitions **Error! Bookmark not defined.**

Table 6: Dialog Semiconductor **Error! Bookmark not defined.**

DA14585/DA14586 Getting Started Guide with the Basic Development Kit**1 Terms and Definitions**

- BLE** Bluetooth® Low Energy
- COM** Communication Port
- CS** Chip Select
- DBG** Debug
- EEPROM** Electrically Erasable Programmable Memory
- FTDI** Future Technology Devices International
- GPIO** General Purpose Input/Output
- IDE** Integrated Development Environment
- IRQ** Interrupt Request
- LED** Light Emitting Diode
- OS** Operating System
- OTP** One Time Programmable
- PC** Personal Computer
- RF** Radio frequency
- SDK** Software Development Kit
- SoC** System on Chip
- SPI** Serial Peripheral Interface
- SRAM** Static Random Access Memory
- SW** Software
- SWD** Serial Wire Debug
- TCK** JTAG Test Clock
- TMS** JTAG Test Mode Select
- UART** Universal Asynchronous Receiver/Transmitter
- USB** Universal Serial Bus

2 Prerequisites

- Minimum hardware requirements:
 - Windows Operating System, 1 GHz, 32-bit or 64-bit processor
 - 1 GB of system memory (RAM)
 - 2 GB of available disk space
- Basic Development Kit DA14585/586 and accessories
- Serial-port terminal software (for example, Tera Term)
- A USB connection supporting USB-Serial (FTDI)

DA14585/DA14586 Getting Started Guide with the Basic Development Kit

3 Introduction

The DA14585/586 is a family of Bluetooth Smart SoC devices that operate at very low power levels while providing world-class RF performance.

The devices are available in a small footprint while still offering a large flexibility in configuration of the on-chip interfaces making them suitable for a wide range of applications. More information can be found in the [DA14585 Datasheet](#).

The development kit includes a set of hardware (for example, a development board with an on-board debugger) and is supported by a Software Development Kit (SDK) (that is, a development toolchain, source code examples, and so on), and documentation.

The purpose of this guide is to provide an overview of the DA14585/586 Basic Development Kit Board and describe the setup of the hardware and installation of the software tools to fully use the board.

The following hardware and software elements are required to use the DA14585/586 Development Kit:

- The [Basic Development kit](#)
- SmartSnippets™ Studio which can be installed on Windows, see **Section 8**.
- Windows users should download and install terminal software such as RealTerm, Putty or Tera Term. This document uses Tera Term for its examples.

The rest of guide is organized as follows:

- **Section 6** describes the hardware components and their initial installation and setup.
- **Sections 7 and 8** describe the installation of the SmartSnippets™ DA14585/586 SDK software, along with all necessary tools.
- **Section 9** contains all steps for downloading and executing your first DA14585/586 Applications.

3.1 Kit Content

The Basic Development Kit parts can be ordered via various [distributors](#). The Basic Development Kit contains the following:

- Bluetooth low energy Board
- Mini USB-cable
- Coin cell battery (CR2032)

DA14585/DA14586 Getting Started Guide with the Basic Development Kit

4 The DA14585/586 Hardware

The basic Development Kit consists of a single basic Board containing the DA14585/586 BLE SoC in QFN40 package. For the schematics and layout of the board in full detail, please refer to the respective documents on the [portal](#).

4.1 The Basic Kit board

Figure 1 illustrates the physical layout of the Basic Kit board. The basic Kit board provides the necessary hardware to enable:

- Full digital connectivity with external hardware using UART, SPI, GPIO, and I²C
- USB based debugging capabilities using the SEGGER J-Link on-board debugger

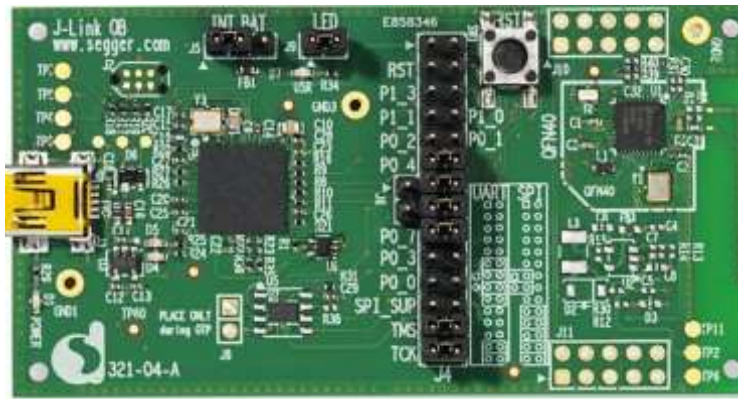

Figure 1: The DA14585/586 Basic Kit

4.2 Configuring the Basic Kit Board by Jumper Settings

The DA14585/586 supports booting from UART. The jumper settings are displayed below:

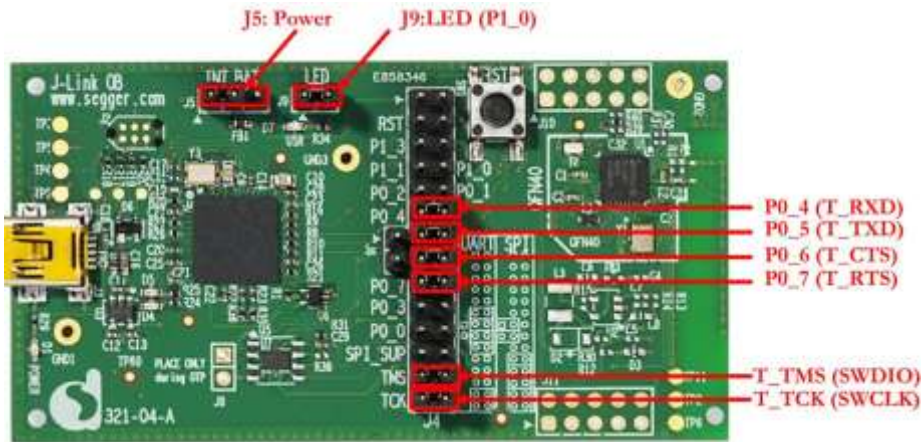

Figure 2: The DA14585/586 Basic Kit Jumper Setting

Figure 3 shows the layout of the header jumper, J4.

DA14585/DA14586 Getting Started Guide with the Basic Development Kit

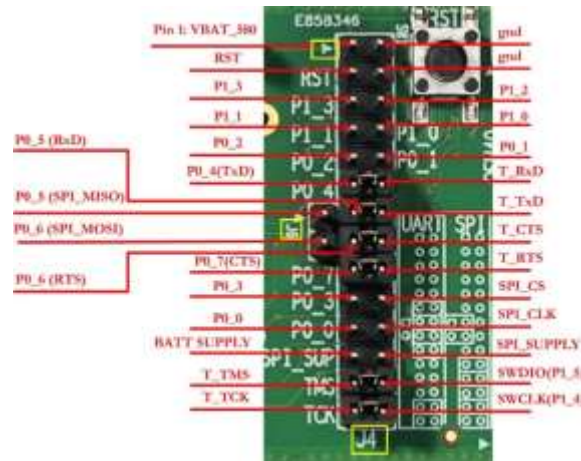

Figure 3: Jumper 4 Layout

Note: Please notice that the signals connected on the DA14585/586 SoC are located on the left pins row of header J4 as shown in Figure 4.

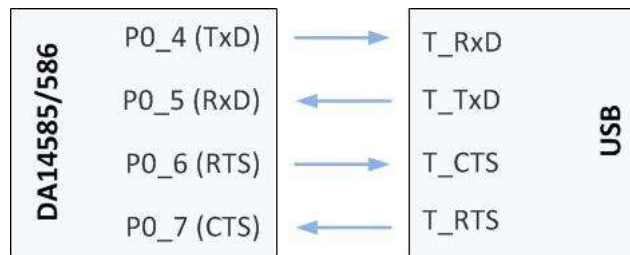

Figure 4: Data direction of UART within J4

Note:

- UART connectivity is enabled by shorting header as presented in Figure 2.
- UART connection between DA14585/586 and the MCU that provides communication over USB to a PC is realized through PO_4, PO_5 (for null mode), PO_6 and PO_7 (for full UART).

For DA14585, data flash through SPI connectivity is enabled with the jumper configuration which is presented in Figure 5.

Please notice that for DA14586, this configuration is meaningless and it must be avoided. DA14586 SoC incorporates the flash internally (2Mbits).

DA14585/DA14586 Getting Started Guide with the Basic Development Kit

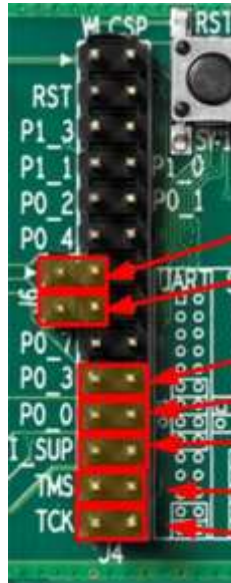

Figure 5: DA14585/586 Boot from external SPI memory

4.3 Board Layout

The layout of the basic board is displayed in Figure 6.

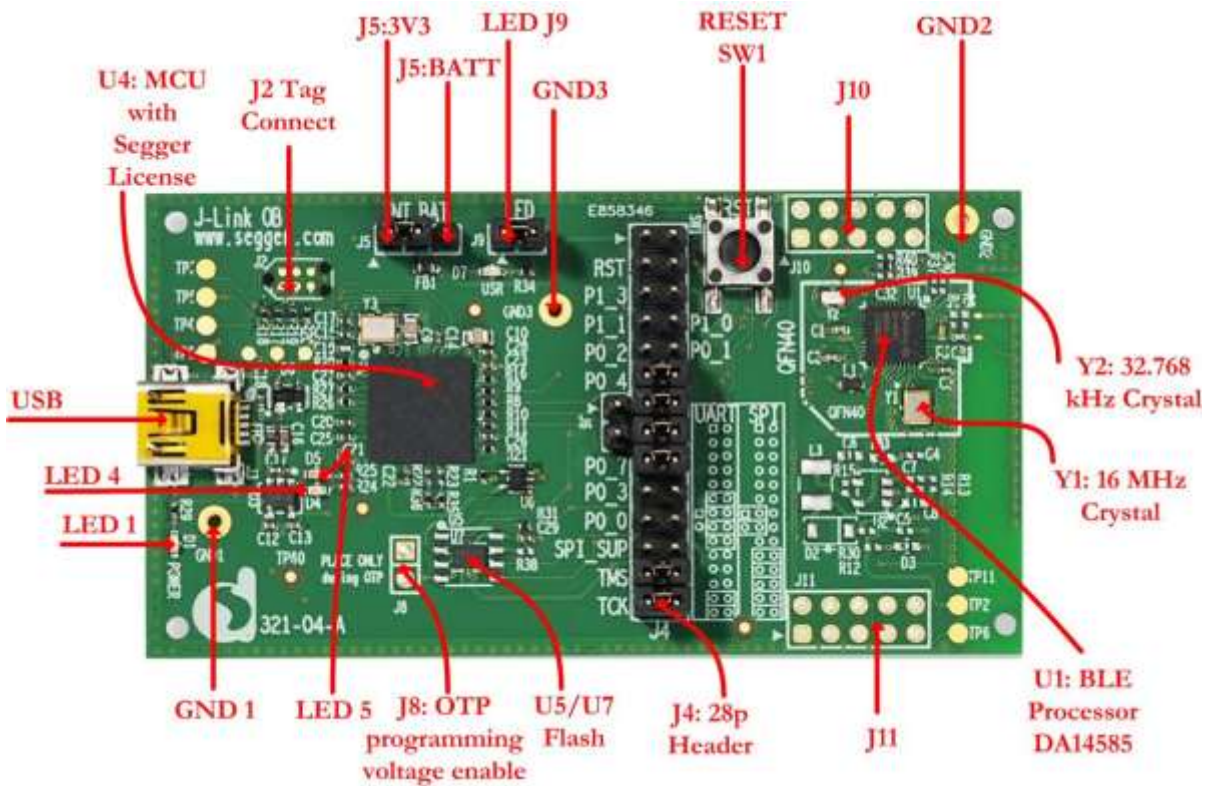

Figure 6: DA14585/586 Basic Board layout

DA14585/DA14586 Getting Started Guide with the Basic Development Kit

Components of Basic development kit:

- **U1:** Dialog BLE SoC, DA14585 or DA14586 in QFN40 package. DCDC converter of SoC is configured in Buck mode. Two crystals are used, 16MHz and 32.768 KHz.
- **U5** or **U7:** SPI data flash, MX25R2035. Two packages are available, U5 –WSON MX25R2035FM1IH0 and U7-SOIC8 - MX25R2035FZUILO – (default). For DA14586, flash memory is not mounted.
- **U4:** MCU where Segger license is applied. UART and JTAG connectivity is provided to DA14585/586 SoC
- **SW1:** Reset push button. By pressing the button, user can hardware reset the processor
- **J4:** 28 pins header. Signal and power pins of DA14585/586 are provided. Also the interconnection between BLE processor and Segger license MCU for JTAG and UART is done through jumpers.
- **J5:** 3 pins connector. DA14585/586 can be supplied by either 3.3V generated from on the development kit or by coin cell battery applied on the bottom side of the development kit.
- **J9:** two pins header. It enables user LED. LED is driven from P1_0.
- **J10:** 10 pins header. It is used for monitoring DA14585/586 port 2 pins.
- **J11:** 10 pins header. Only P3_0 is provided on pin 1. Please notice that for DA14586, P3_0 is not used.

Note: The schematic diagrams, BOM, and Gerber files are illustrated in detail in the [Development Kit Documentation](#).

4.4 Connecting the Basic Kit to the host PC

The Basic Kit includes an embedded J-Link debugger which allow easy communication with the development host over USB.

The DA14585/586 SoC is configured only in Buck mode on this development kit. A choice can be made between 3.3 V (via USB: J5 1-2) or VDD (a coin cell: J5 2-3). No battery is needed when running via the mini-USB cable.

Note: The basic Kit is connected to the host PC over the connector marked as USB (J3), as shown in Figure 6 using a standard mini-USB cable.

DA14585/DA14586 Getting Started Guide with the Basic Development Kit

5 DA14585/586 Software Installation

This section describes the installation procedure for the drivers, the configuration of the serial port, and all necessary steps to verify the connection with the PC. It also provides solutions to problems that may occur.

5.1 Requirements of the Development PC

For proper evaluation and application development using the DA14585/586 SoC and the Basic Development Kit, an external host is required. This external host must have a Windows already installed and USB ports as described in **Section 6**.

5.2 Driver Installation

On first connection to a host PC running Microsoft Windows, the system will detect several devices and will automatically install all necessary drivers. If the system is configured to use Windows Update, this may take several minutes to complete.

When the driver installation is complete, the system displays a window similar to the one presented in **Figure 7**.

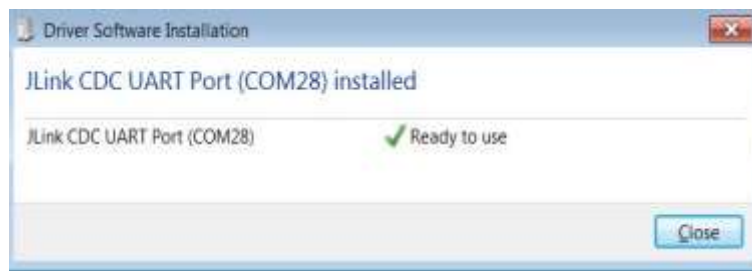

Figure 7: Windows Driver Installation

There is one virtual COM port created by the Windows driver. This COM port (COM28 in this example) provides a UART interface between the PC and the DA14585/586 device. For current measurement please refer to the **Figure 36** in **Appendix C**.

You can find also more information about the Power Profiler, see the [SmartSnippets Toolbox User Manual \(UM-B-083\)](#).

Note: The COM port number assigned to the might be different to the one shown in **Figure 7**.

The COM port number can be found in the Windows Device Manager (Control Panel > Device Manager > Ports (COM & LPT)) as shown in **Figure 8**.

DA14585/DA14586 Getting Started Guide with the Basic Development Kit



Figure 8: Device Manager Port

5.3 Configuring the Serial Port for UART

Several development tools require UART to be routed to the FTDI serial port. Refer to **Figure 32** in **Appendix B** for the Basic Development Kit board connection verification and on how to properly configure the specific port.

5.3.1 Using Serial Port

To make sure that the communication between the board and the Windows development host is properly established, it is necessary to verify the UART connection between the two nodes.

On the Windows host, Tera Term can be used to validate the connection to the by Basic Development Kit following these steps:

1. Connect the Basic Development Kit board to the PC via USB cable. The location of the board's USB port is shown in **Figure 6**.
2. Use the Windows Device Manager to verify that the host discovered the **COM28** serial port in this case. See **Figure 8**.
3. Open Tera Term from the Windows Start menu as shown in **Figure 9**.



Figure 9: Start Tera Term

4. In the **Tera Term: New connection** dialog, select **Serial**, then select the **COM Port** to use, and click **OK**.
5. Select **Setup > Serial Port** and configure your UART port using the parameters shown in **Table 1** (you need to be an administrator on your local machine), see **Figure 10**.

DA14585/DA14586 Getting Started Guide with the Basic Development Kit

Table 1: Parameters for Connecting to UART

Settings	Values
Baud rate	115200
Data bits	8
Parity	None
Stop bits	1
Flow Control	None

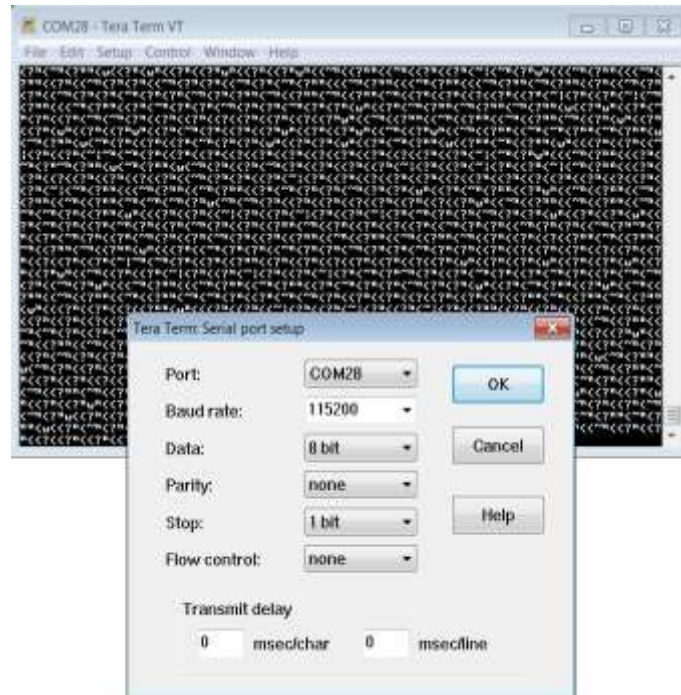

Figure 10: Setting Up the Port and Testing Connectivity via Tera Term

5.4 Troubleshooting

If there are any problems with the connection to PC some possible solutions might be:

- Check for possible cabling issues by using a different USB cable.
- Connect the two elements using a different USB port on the host PC.

Note: If none of these actions resolve the issue, please contact [Dialog Tools Forums](#).

6 Software Development Tools

Dialog SmartSnippets™ Studio is a royalty-free software development platform for Smartbond™ devices. It fully supports the DA14585/586 family of devices.

For the DA14585/586, KEIL **must** be used for compilation and debug instead of using the supplied SmartSnippets GNU ARM GCC. KEIL needs to be installed separately (it is not included).

SmartSnippets™ Studio contains:

DA14585/DA14586 Getting Started Guide with the Basic Development Kit

- SmartSnippets™ Toolbox which covers all software development requirements, including:
 - programming and loading of firmware into SRAM, OTP, and Flash
 - power profiling
- SmartSnippets™ documentation

The SmartSnippets™ IDE is enabled by an on-board J-Link debugger from SEGGER. This offers standard debug capabilities such as single stepping, setting breakpoints, software download and many more. For more details on the debugger capabilities, visit <https://www.segger.com/>.

6.1 SmartSnippets™ Installation

The installation procedure for SmartSnippets™ Studio is described in detail in [UM-B-057 SmartSnippets Studio User Manual](#).

A summary of the steps is given here.

1. Download the latest version of SmartSnippets™ Studio from [Software and tools](#), as shown **Figure 11**.

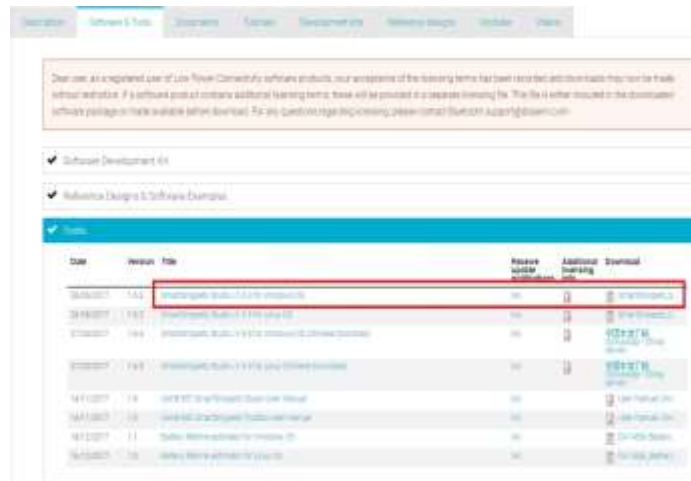

Figure 11: SmartSnippets Studio Install Link

2. Run the SmartSnippets™ Studio installer (.msi). Several of the required tools are automatically installed, others need to be manually downloaded and installed.
3. Select to install the latest version of SEGGER J-Link GDB server and click **Next**.

DA14585/DA14586 Getting Started Guide with the Basic Development Kit

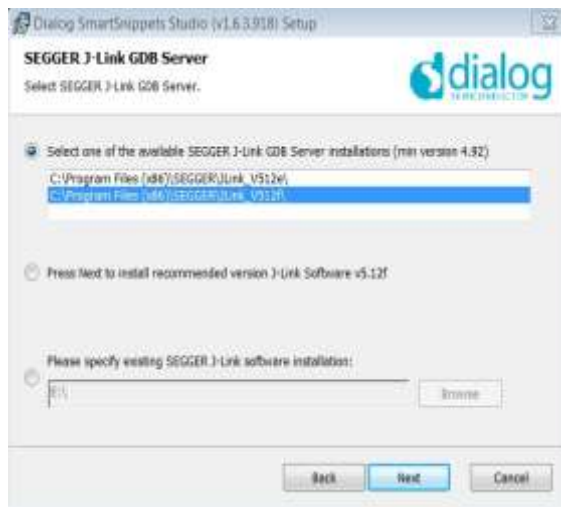

Figure 12: Automatically Install J-Link

4. Select the destination folder for the SmartSnippets™ Studio and click **Next**.



Figure 13: Select SmartSnippets™ Studio Install Directory

The SmartSnippets™ Studio is installed.

Note:

- The default Windows installation folder for SmartSnippets™ Studio is C:\DiaSemi.
- When Windows Defender is turned ON it will prevent the file SmartSnippets™ Studio installer (.msi) from automatically running, click Run Anyway when prompted.
- Administrator access is required to install SmartSnippets Studio software components.

DA14585/DA14586 Getting Started Guide with the Basic Development Kit

6.2 KEIL Installation

KEIL μ Vision IDE must be downloaded and installed separately, registration is required.

1. Download and install the Keil tools from <https://www.keil.com/demo/eval/arm.htm>.

Note: The Keil development tools can be run as a Lite/Evaluation version without a product license, see Figure 14 (File > License Management). This Lite/Evaluation version has a 32 kB of code (in ROM) limitation.



Figure 14: Keil Lite version

2. When the install is complete, a list of packs is shown, see Figure 15. If you do not see this list:
 - a. Click the **Packs Installer** button (or select **Project > Manage > Pack Installer**).
 - b. Click the **Check for Updates** button to show an updated list of packs.
3. Click on the **Install** or **Update** button next to the “ARM::CMSIS” package if it is not up to date.

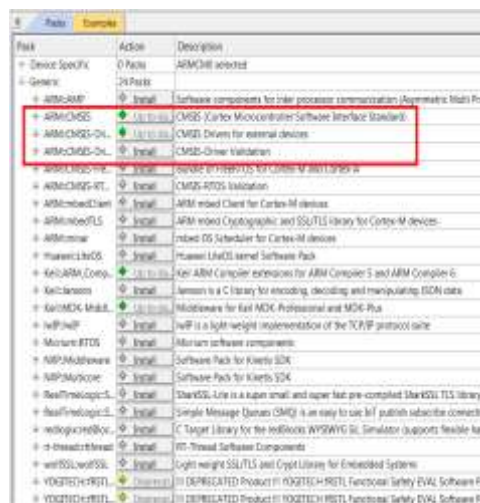

Figure 15: CMSIS Package Installation

DA14585/DA14586 Getting Started Guide with the Basic Development Kit

If the installation was successful, the Pack Installer window will show the summary displayed in **Figure 16**.

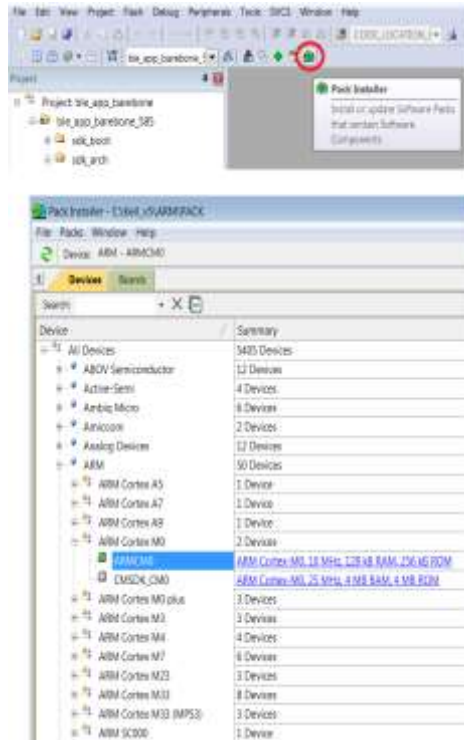

Figure 16: CMSIS Package Installation Successful

7 Build a DA14585/586 Application

This section explains how the user can build, program, and run a simple software application on the board.

It provides step-by-step instructions for loading the example as a project in the Keil environment, setting it up and building it, and finally executing it via the debug environment on any of the DA14585/586 devices.

Make sure that you have all required tools installed as described in **Section 7** and **Section 8**.

The DA14585/586 Software Development Kit (SDK) includes examples running on the Pro and the Basic Development Kits. The examples are provided with preconfigured KEIL projects.

The SDK zip archive is downloaded from the [customer support web page](#).

More details are provided in the [DA14585 & DA14586 Software Developer's Guide \(UM-B-080\)](#).

7.1 The Blinky Peripheral Example Application

Blinky is a simple application which demonstrates basic initialization of DA14585/586 and LED blinking. After downloading the SDK, the blinky source code example can be found in the directory called peripheral_examples.

1. Open the folder containing the SDK files. This is the folder where you extracted the SDK zip file.

DA14585/DA14586 Getting Started Guide with the Basic Development Kit

- In `<sdk_root_directory>\projects\target_apps\peripheral_examples\blinky\Keil_5`, double-click **blinky.uvproj** to open the project in Keil.

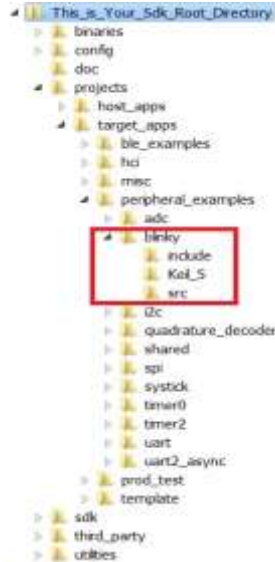

Figure 17: Blinky Project directory

The development environment should look like this when the project is opened with Keil:

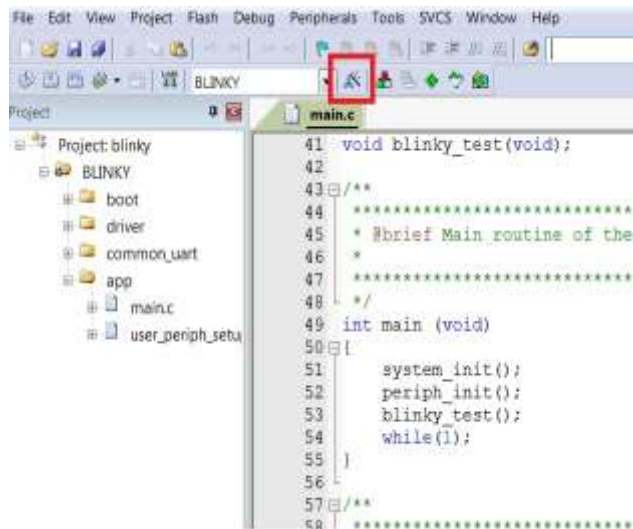

Figure 18: Blinky Project Keil Workspace

- Click on the **Target Options** button, then click on the **Device** tab. The dialog should look like this.

DA14585/DA14586 Getting Started Guide with the Basic Development Kit

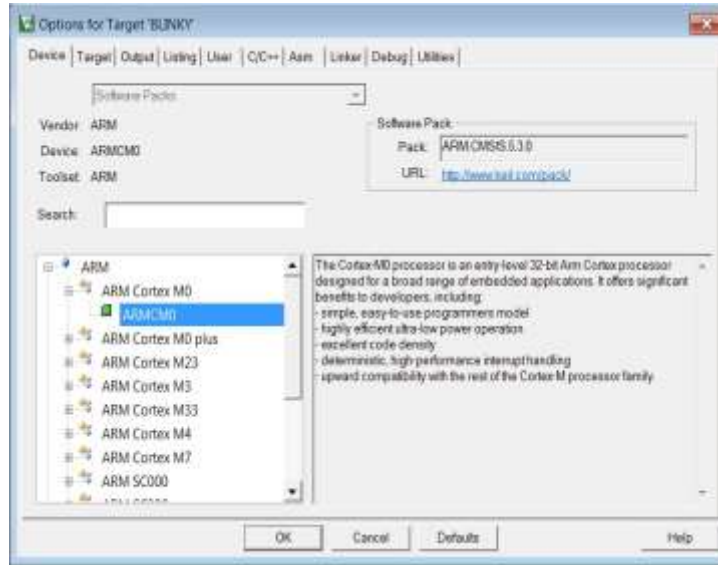

Figure 19: Blinky Project Options

- Click on **Linker**. Scatter files (.sct) are used for selecting memory areas.



Figure 20: Blinky Project Scatter File

- Click on **Debug** and ensure **J-LINK/J-TRACE Cortex** is selected and that the **Initialization File** is set correctly to **.sysram.ini**.

DA14585/DA14586 Getting Started Guide with the Basic Development Kit

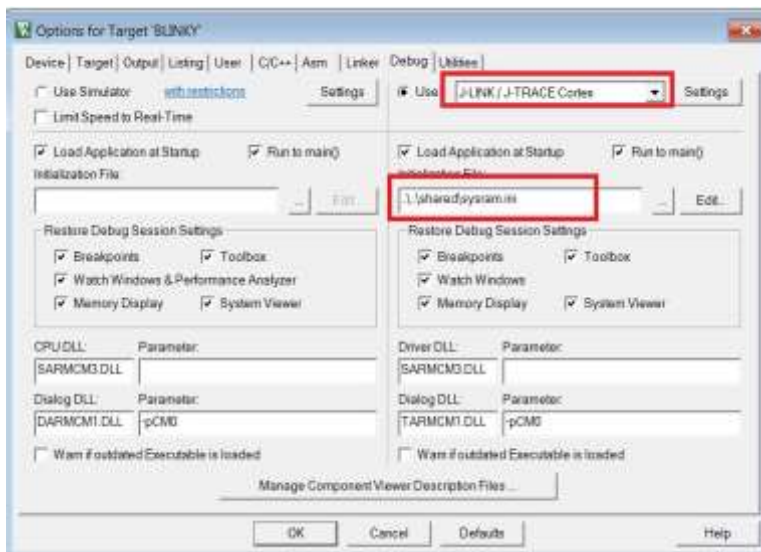

Figure 21: Blinky Project: Debug Option

- Click on **Settings** and check that the SW Device has been detected correctly.



Figure 22: Blinky Project: Jlink setup

- Click **OK** to save the settings in both windows. All settings have now been saved and you can continue to build the example.
- Build the project by pressing F7 key, or clicking the Build button, see **Figure 23**.

DA14585/DA14586 Getting Started Guide with the Basic Development Kit

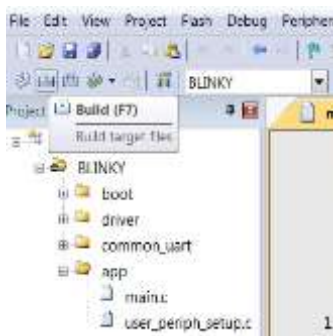

Figure 23: Blinky Project: Project Building

9. Make sure you have a UART connection between your PC and the motherboard, as shown in **Figure 8**. Check the COM number on your PC.
10. Open Tera Term, choose the COM port from step 9, and click **OK**.
11. Select **Setup > Serial Port** to configure the port as shown in **Table 1**.
12. In Keil, select **Debug > Start/Stop Debug Session**.

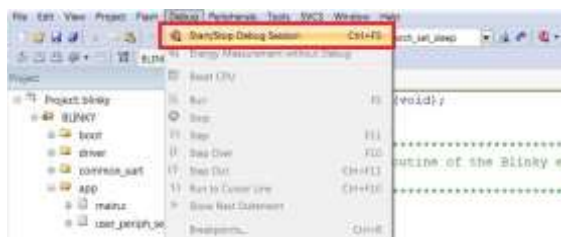

Figure 24: Blinky Project: Start Debug Session

13. If a non-licensed version of Keil is used, the following dialog is displayed. Click **OK**.

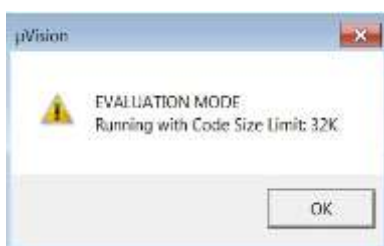

Figure 25: Keil Lite Pop Up Window

14. Press **F5** or click the **Run** button to start code execution.

DA14585/DA14586 Getting Started Guide with the Basic Development Kit

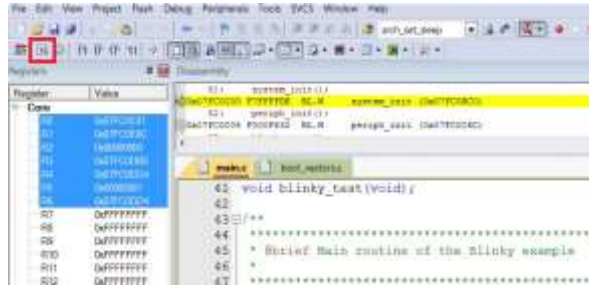

Figure 26: Blinky Project: Code Execution

When the blinky message is displayed on your UART terminal screen and the green LED is blinking you have successfully programmed and started the blinky program on DA14585/586 Demo board.

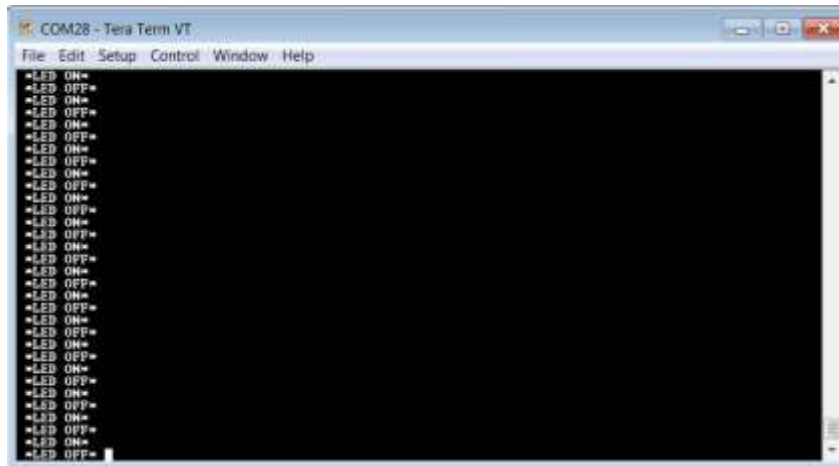

Figure 27: Blinky Project: Blinky message on COM28 terminal

7.2 The Barebone BLE Example Application

The Barebone BLE example application demonstrates basic BLE procedures such as advertising, connection, updating connection parameters, and implementation of the Device Information Service Server (DISS). See the [Bluetooth SIG](#) for more details.

1. Open the folder containing the SDK files. This is the folder where you extracted the SDK zip file.
2. In `<sdk_root_directory>\projects\target_apps\ble_examples\ble_app_barebone\Keil_5`, double-click `ble_app_barebone.uvproj` to open the project in Keil.

DA14585/DA14586 Getting Started Guide with the Basic Development Kit

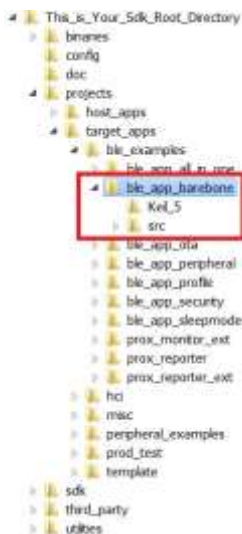

Figure 28: Barebone BLE Project directory

Figure 29 shows the Keil project layout.

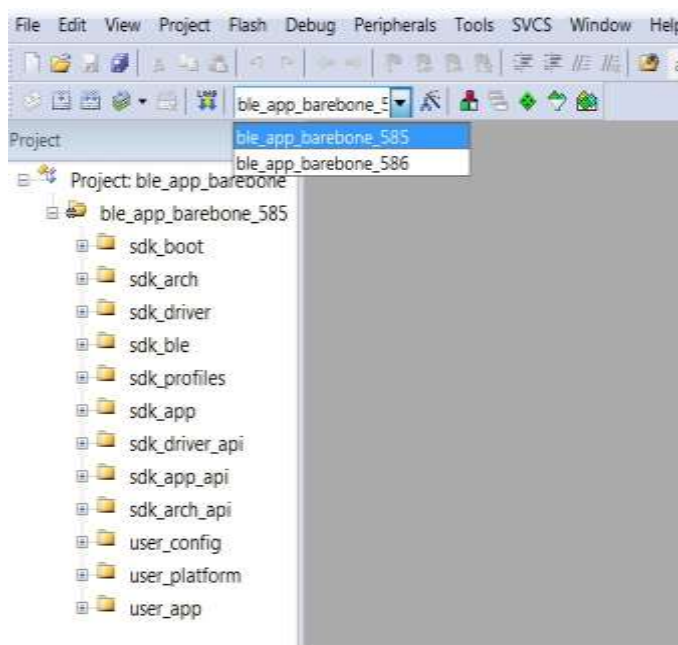

Figure 29: Barebone BLE: KEIL Project Layout

3. To execute the code and run the example, repeat steps 3 to 14 in [The Blinky Peripheral Example Application](#).
The barebone application does not use the UART and so the only jumpers required are those for the debugger interface as noted in **Table 3**.
4. Use the Android application BLE Scanner to scan for, and connect to, the DIALOG-BRBN app, see **Figure 30**.

DA14585/DA14586 Getting Started Guide with the Basic Development Kit

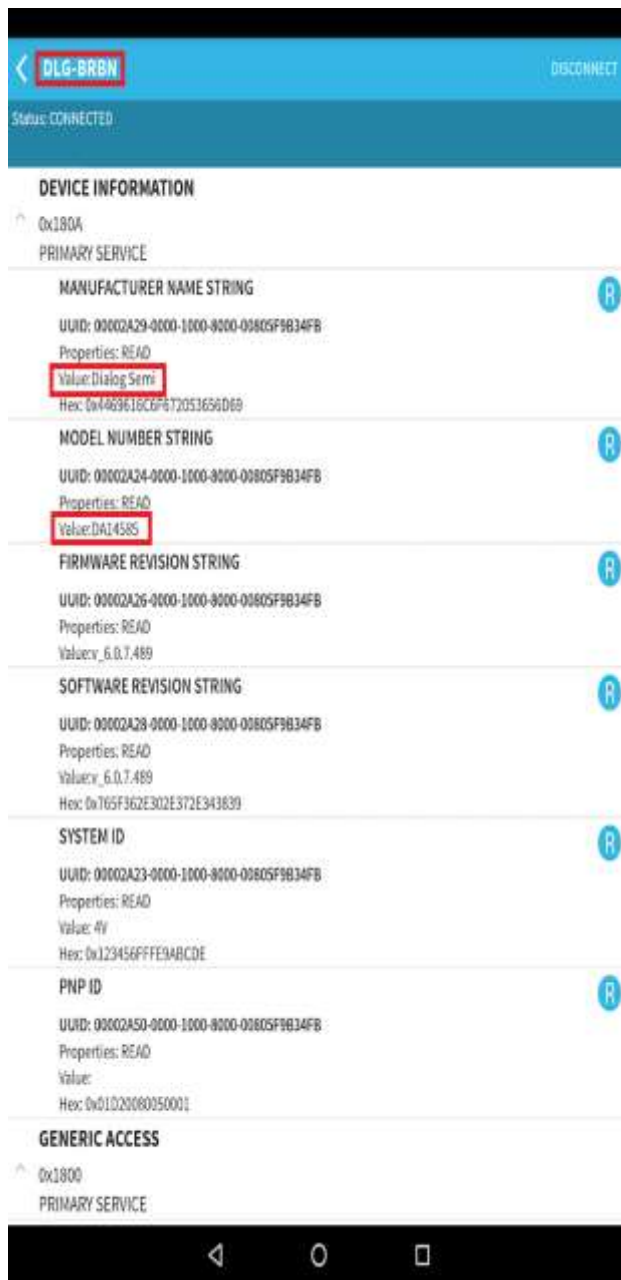

Figure 30: Barebone BLE: Interacting with BLE Application

Your BLE application is now running and advertising using the default advertiser string: "DIALOG-BRBN".

Note: In this example, we used an Android application but you can also use the LightBlue iOS application to connect an iPad/iPod/iPhone device to the application.

DA14585/DA14586 Getting Started Guide with the Basic Development Kit
7.3 Troubleshooting

- If you can't see any blinky messages in your UART terminal and the LED is not blinking, check the UART and LED jumper configuration, see **Table 2**. You can also make sure that the hardware configuration is set for, see **Figure 31** in **Appendix A**

Table 2: Blinky Example UART and LED Jumper Configuration

GPIO	Function	Jumper
P0_4	UART2 TX	Connect J4.11 - J4.12
P0_5	UART2 RX	Connect J4.13 - J4.14
P1_0	LED	Connect J9.1 – J9.2

If you can't start a debug session, check the SWD debugger jumper configuration, see **Table 3**.

Table 3: Blinky Example SWD Debugger Jumper Configuration

JTAG	Function	Jumper
TMS	SWD IO	Connect J4.25 - J4.26
TCK	SWD CLK	Connect J4.27 - J4.28

If you have trouble with the J-link firmware or any issue with SDK operation, refer to the [DA1458x/68x Development Kit J-Link Interface Application Note AN-B-052](#).

Note: If none of these actions resolved the issue, please contact [Dialog Software Forum](#).

7.4 What Next?

This tutorial does not cover all the topics relevant to software development environments, it describes the first steps necessary to get started with the Pro Development Kit. The following links provide more information on DA14585/586:

- [DA14585 Product Brief](#): To know more about the SmartBond™ DA14585 SoC.
- [DA14586 Product Brief](#): To know more about the SmartBond™ DA14586 SoC.
- [UM-B-079: DA14585/586 SDK 6 Software Platform Reference](#): To know more about software architecture.
- [UM-B-080: DA14585/586 SDK 6 Software Developer's Guide](#): To build more BLE and peripheral examples.
- [Codeless Tutorial](#): To quick start your IoT application and learn more about AT commands.
- [Sleep mode configurations and power measurement](#): To learn more DA14585/586 Power management.
- [Application Hardware Design Guideline](#) : To learn how to prepare schematics and PCB layouts for your application.

DA14585/DA14586 Getting Started Guide with the Basic Development Kit

8 Appendices

8.1 Appendix A: Using the Basic Development Kit

The *user_periph_setup.h* file contains hardware settings related to the used. The default is the ProDev Kit.

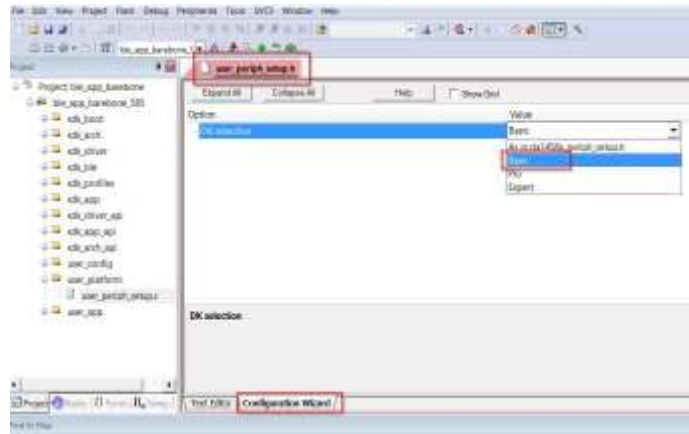

Figure 31: Hardware Settings for Basic Development Kit

8.2 Appendix B: Latency Timer of the FTDI cable

If an external FTDI cable is used to burn the OTP (or to download the image into the external memory), the latency timer of the FTDI cable has to be changed from 15 ms to <10 ms.

To change the latency timer:

1. In the Windows **Device Manager**, expand the list of COM ports.
2. Right click on the required COM port and select **Properties**.
3. In the **Port Settings** tab, click **Advanced**.
4. Set the **Latency Timer** to < 10 ms.

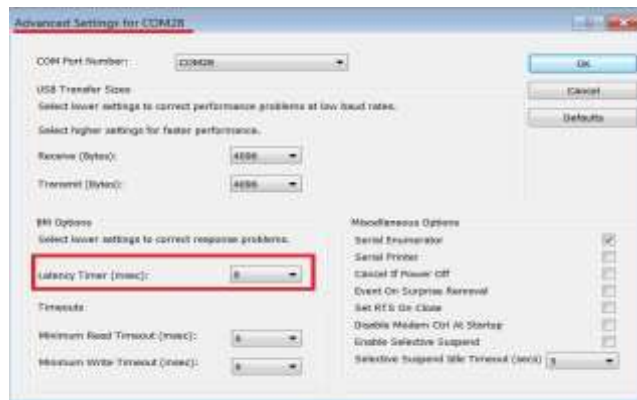

Figure 32: FTDI Latency Timer

DA14585/DA14586 Getting Started Guide with the Basic Development Kit

8.3 Appendix C: Power Management: measuring current

The design of the DA14585 and DA14586 Basic Development Kit is made in such a way that the microcontroller can be isolated completely from the rest of the board. This is illustrated in the block diagram shown in **Figure 33** and **Figure 34** that showing the connections of the jumpers J4, J5 and J6.

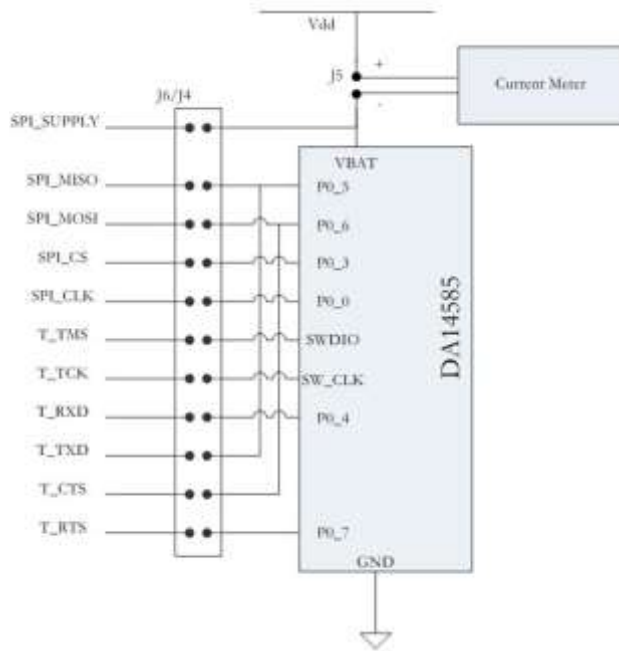

Figure 33: Setup of DA14585 Basic Development Kit during power measurement

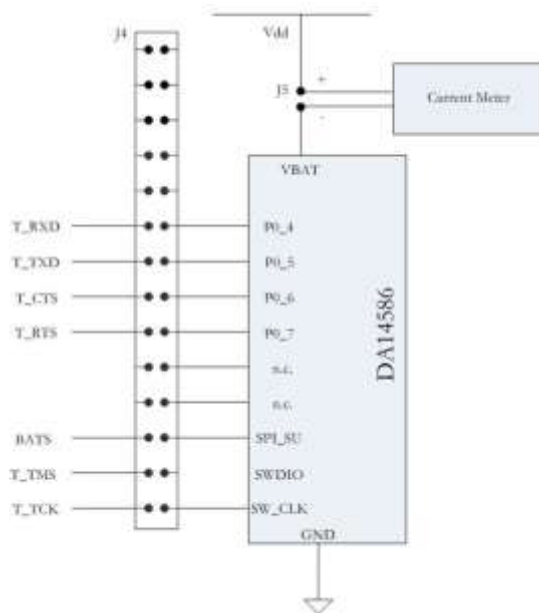

Figure 34: Setup of DA14586 Basic Development Kit during power measurement

DA14585/DA14586 Getting Started Guide with the Basic Development Kit

Steps how to do the power measurements:

1. Connect the Current Meter to jumper J5.
2. Mount the jumpers needed for downloading the software.
3. Download the software.
4. Start the software.
5. Wait till software has reached 'Deep Sleep'.
6. Dismount all the jumpers.

Now almost all the DA14585/586 pins are isolated and only the current meter and GND are connected.

7. Read the current.

For additional info: see [AN-B-015 DA14580/581 Supply current measurements](#). See chapter 4.4 Deep Sleep current measurement.

**DA14585/DA14586 Getting Started Guide with
the Basic Development Kit****Revision history**

Revision	Date	Description
1.0	27-Aug-2015	Initial version for DA1458x family with SDK 5.
1.1	20-Oct-2015	Minor Update in Keil installation instructions.
1.2	22-Jan-2017	Add DA14585/586.
2.0	09-Jul-2018	First HTML released version. Keep only DA14585/586.
2.1	19-Jan-2022	Updated logo, disclaimer, copyright.

DA14585/DA14586 Getting Started Guide with the Basic Development Kit**Status Definitions**

Status	Definition
DRAFT	The content of this document is under review and subject to formal approval, which may result in modifications or additions.
APPROVED or unmarked	The content of this document has been approved for publication.

RoHS Compliance

Dialog Semiconductor's suppliers certify that its products are in compliance with the requirements of Directive 2011/65/EU of the European Parliament on the restriction of the use of certain hazardous substances in electrical and electronic equipment. RoHS certificates from our suppliers are available on request.