

US082-FS3000EVZ

FS3000 Pmod™ Board

The US082-FS3000EVZ board enables quick prototyping of the FS3000 mass air velocity sensor module for a custom system design. The board provides a standard Pmod Type 6A (Extended I²C) connection for the onboard sensor to plug into any MCU evaluation kit with a matching connector.

The US082-FS3000EVZ features Pmod connectors on both sides of the board allowing additional Type 6/6A boards to be connected in a daisy-chained solution with multiple sensors on the same MCU Pmod connector. Because of the standard connector and software support, the US082-FS3000EVZ is ideal for the Renesas Quick-Connect IoT to rapidly create an IoT system.

Kit Contents

- US082-FS3000EVZ Board

Features

- FS3000 sensor sample mounted:
 - Thermo-transfer (calorimetric) principle uses MEMS thermocouples to measure flow, which provide excellent signal-to-noise ratio
 - Silicon-carbide coating protects from abrasive wear and water condensation
 - Digital output with 12-bit resolution
 - Resistant to vibration and pressure shock
- Standardized Type 6A Pmod connector supports I²C Extended interface
- Dual connectors allow pass-through signals for daisy-chained solutions

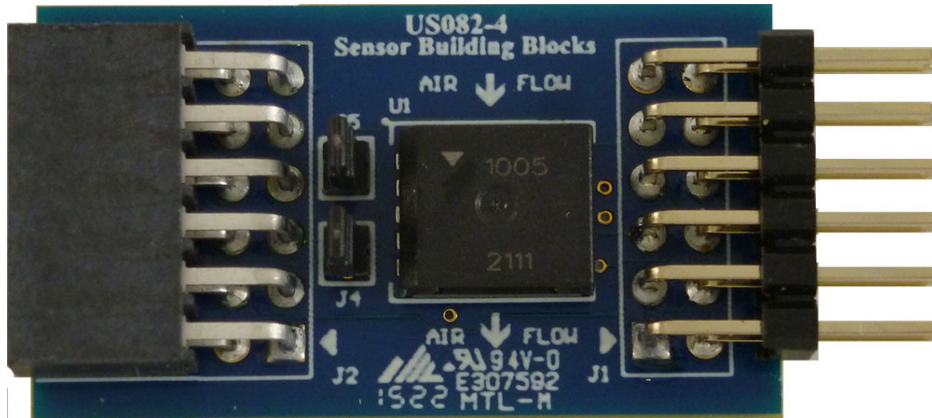

Figure 1. US082-FS3000EVZ Pmod Board

Contents

1. Functional Description	3
2. Setup	3
2.1 Required or Recommended User Equipment	3
2.2 Programming Interface	3
2.3 Software Installation and Usage	4
2.4 Kit Hardware Connections	4
3. Board Design	6
3.1 Schematic Diagram	6
3.2 Bill of Materials	6
3.3 Board Layout	7
4. Ordering Information	9
5. Revision History	9

1. Functional Description

The US082-FS3000EVZ functions as a sensor building block to create a custom system solution. Use the board individually or with a combination of other sensors by using the Pmod Type 6A interface. For a full list of available sensor Pmod boards, visit the Quick-Connect IoT [website](#).

2. Setup

2.1 Required or Recommended User Equipment

The following additional lab equipment is recommended for using the board (and is sold separately):

- Any MCU board that supports Type 6A Pmod.
- The US082-INTERPEVZ interposer board when using one of the Renesas MCU kits ([Table 1](#)).

**Table 1. Renesas MCU Evaluation Kits Capable of Supporting Type 6A PMODs
When Used with the US082-INTERPEVZ^[1]**

RA	RX	Synergy
EK-RA4W1	RX111-Starter-Kit	PK-S5D9
EK-RA2A1	RX231-Starter-Kit	DK-S3A7
EK-RA4M1	RX23W-Starter-Kit	DK-S128
EK-RA6M1	RX23T-Starter-Kit	TB-S1JA
EK-RA6M2	RX24T-Starter-Kit	TB-S3A6
EK-RA6M3	RX24U-Starter-Kit	DK-S7G2
EK-RA6M3G		

1. This table is not a comprehensive list of supported MCU Kits. See the evaluation kit hardware manual to confirm Pmod pinout.

2.2 Programming Interface

Programming of the system can be accomplished through the Renesas IDE, e2 studio. See the MCU evaluation kit documentation to set up the initial project in e2 studio. As the project is initialized, adding the FS3000 sensor to the project takes five steps:

1. Navigate to the file in the FSP Configuration View. In the case shown in [Figure 2](#), select the FS3000 Flow Sensor.
2. Select the FS3000 Stack and edit the configuration values for your required operation.
3. Click the Generate Code icon and the system generates the code to configure the sensor with the MCU.
4. Sample calls are shown in below in the Example Code showing the function that opens the sensors; similar calls are required for the I²C bus. Review the manual related to FSP configuration and function APIs for additional information.
Note: Renesas recommends downloading and reviewing sample projects available on the Renesas website.
5. Use the data in your application.

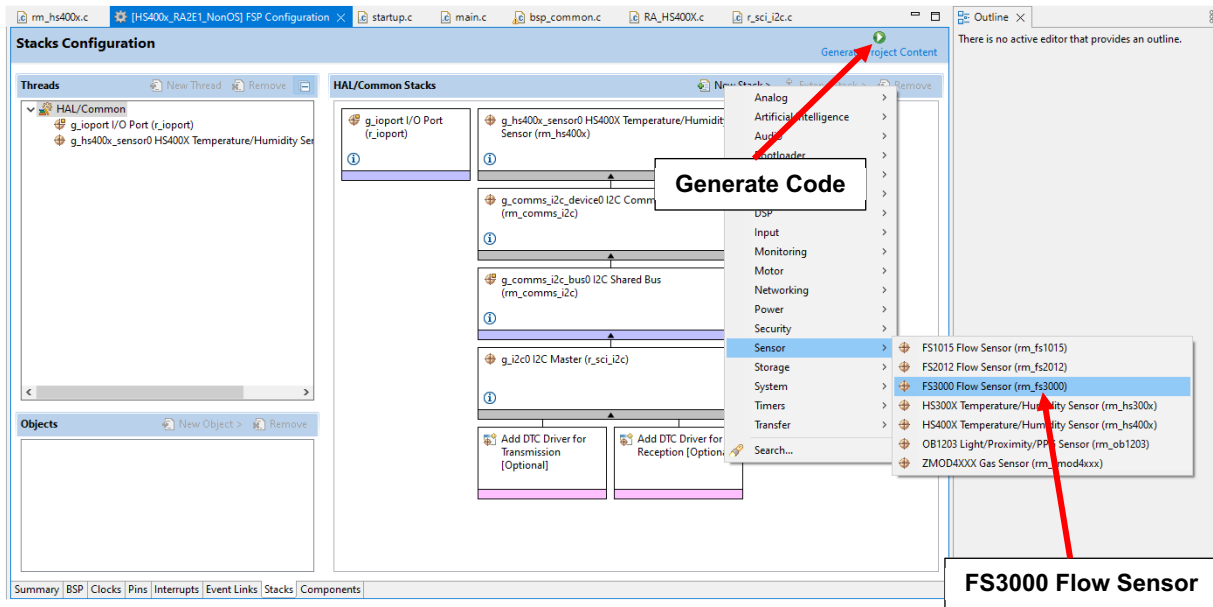

Figure 2. Stack Selection in Renesas e² Studio

Example Code to Start the Sensor after Configuration in FSP

```

/* Quick setup for g_fs3000_sensor0. */
void g_fs3000_sensor0_quick_setup(void)
{
    fsp_err_t err;

    /* Open fs3000 sensor instance, this must be done before calling any FSXXXX API */
    err = g_fs3000_sensor0.p_api->open(g_fs3000_sensor0.p_ctrl, g_fs3000_sensor0.p_cfg);
    assert(FSP_SUCCESS == err);
}
    
```

2.3 Software Installation and Usage

Visit the Renesas [website](#) for the latest version of the e2 studio and for more information on a full system design, software development, and the availability of additional hardware.

The minimum FSP version supporting the FS1015 sensor block is FSP 3.8.0. For the latest sensor support, use the latest release. For the latest connectivity support and details on creating customized IoT system solutions, visit the Quick-Connect IoT [site](#).

2.4 Kit Hardware Connections

Follow these procedures to set up the kit as shown on [Figure 3](#).

1. Verify that the MCU evaluation kit being used has a Pmod connector set to Type 6A. (For help, see the kit hardware manual).
 - a. If no Type 6A Pmod is available, ensure the MCU evaluation kit can use the US082-INTERPEVZ interposer board and insert the board into the MCU connector before adding any sensor boards.
2. Plug in the US082-FS3000EVZ to the Type 6A connector, being careful to align Pin 1 on the sensor board and MCU kit.

3. Connect the J4 and J5 jumpers to place 4.7k pull-up resistors on the I²C bus lines.
 - a. Only one set of pull-up resistors should be used on the I²C bus lines. If multiple sensor boards are used, only one board should have the jumpers present.
 - b. MCU kits typically do not have pull-up resistors present on these lines, so make sure to check for them.
4. The sensor is now ready to be used in the system. Follow the MCU kit instructions for connecting and powering up the evaluation kit.

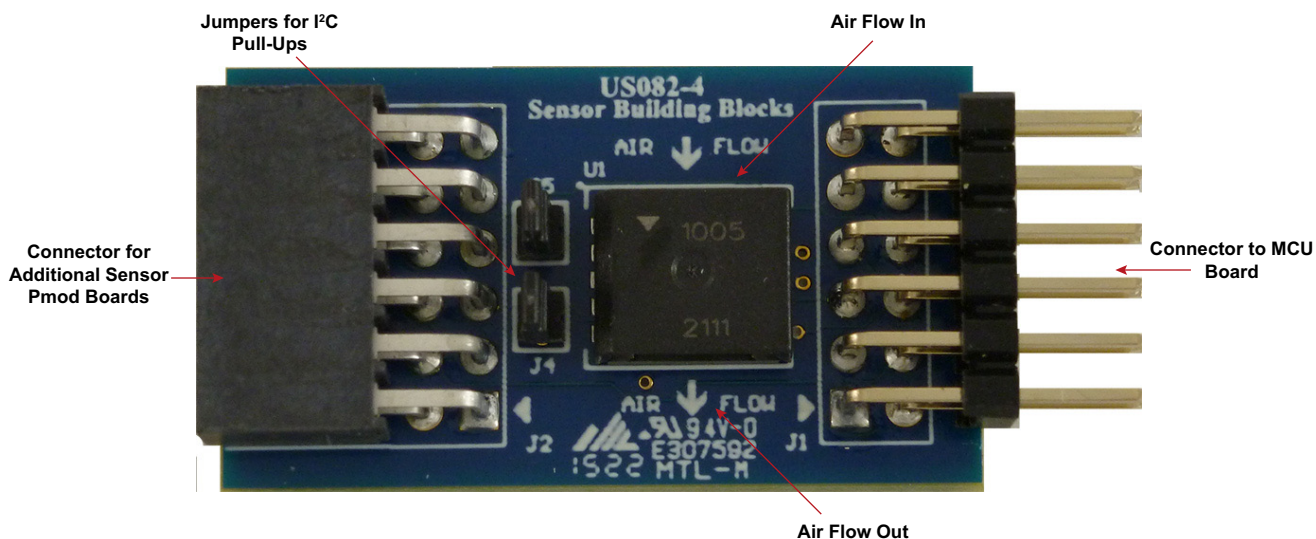

Figure 3. Evaluation Kit Connections

3. Board Design

3.1 Schematic Diagram

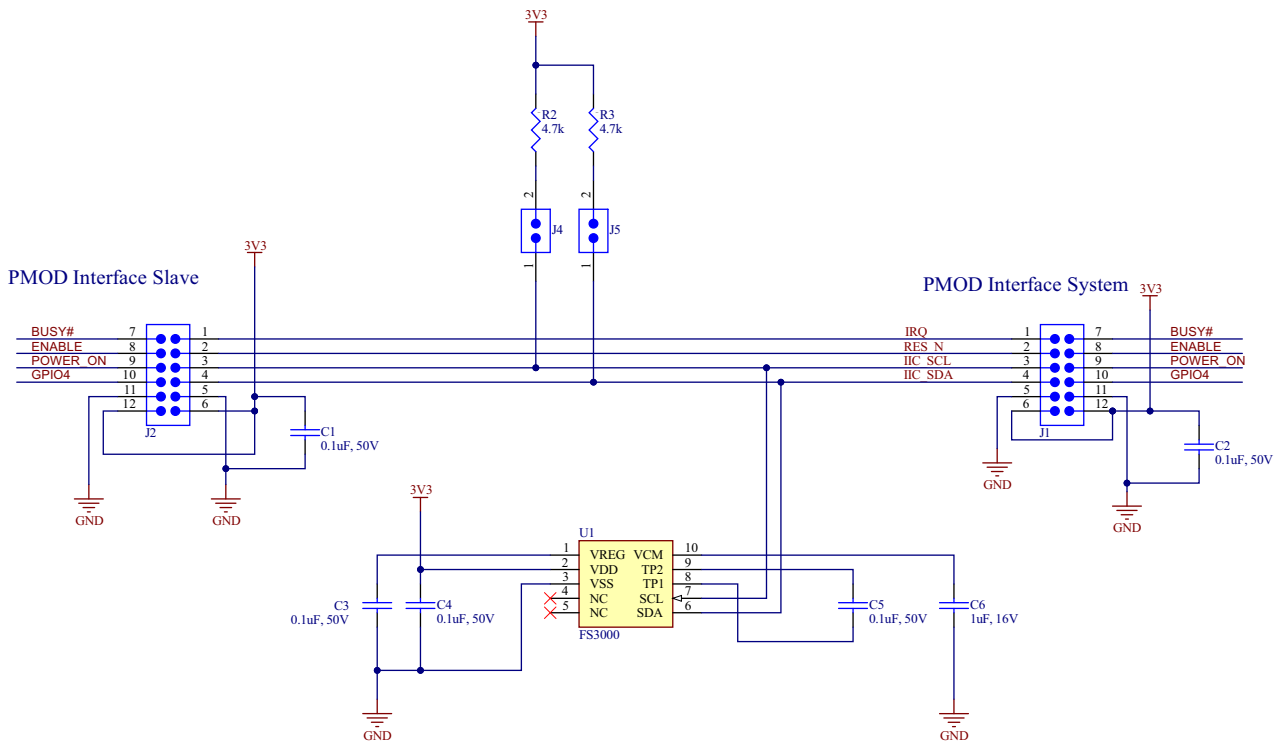

Figure 4. US082-FS3000EVZ Schematic Diagram

3.2 Bill of Materials

Qty	Reference Designator	Description	Value	Manufacturer Part Number
5	C1, C2, C3, C4, C5	Capacitor, 0.1µF, 50V, 0603	0.1µF	C0603C104J5RACTU
1	C6	1µF, X5R, MLCC Ceramic capacitor	1µF	C0603C105K4RACTU
1	J1	Male Header 0.1" pitch PMOD 2×6 Right Angle	Pmod	M20-9950645
1	J2	Female Header 0.1" pitch PMOD 2×6 Right Angle		SSW-106-02-F-D-RA
2	J4, J5	CONN HEADER VERT 2POS 1.27 MM		FTS-102-01-L-S
2	R2, R3	Resistor, 4.7k, 0603	4.7k	RC0603JR-074K7L
1	U1	Flow Sensor Module		FS3001-1005
2	J4, J5	1.27" 1x2 Jumper with Grip, Gold		NPB02SVFN-RC

3.3 Board Layout

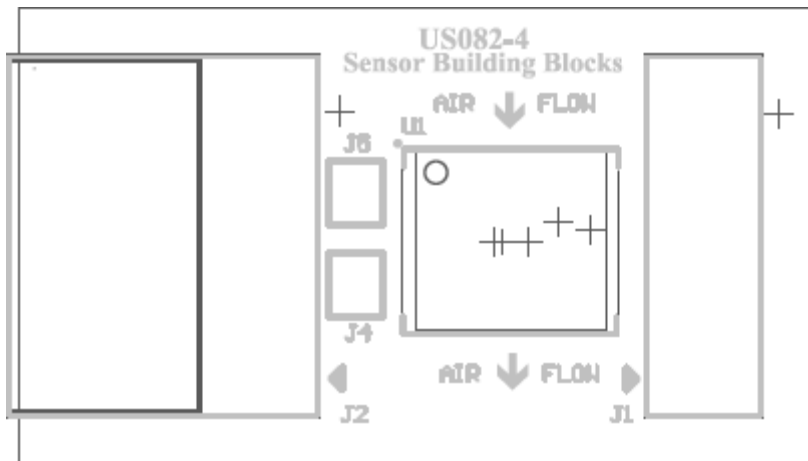

Figure 5. Silkscreen Top

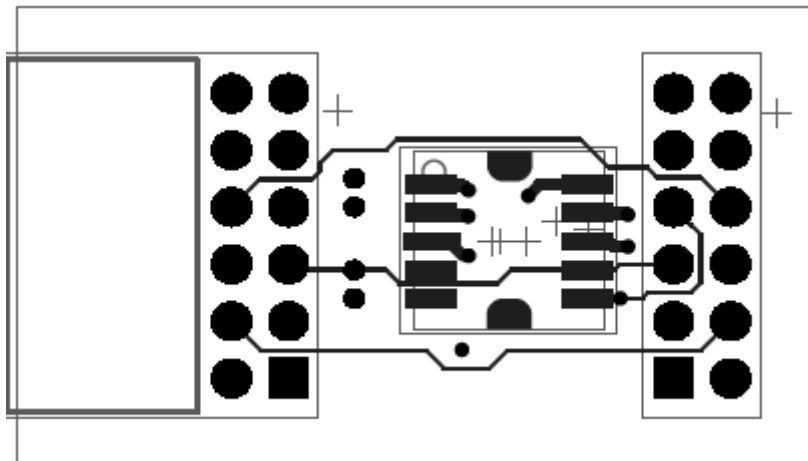

Figure 6. Copper Top

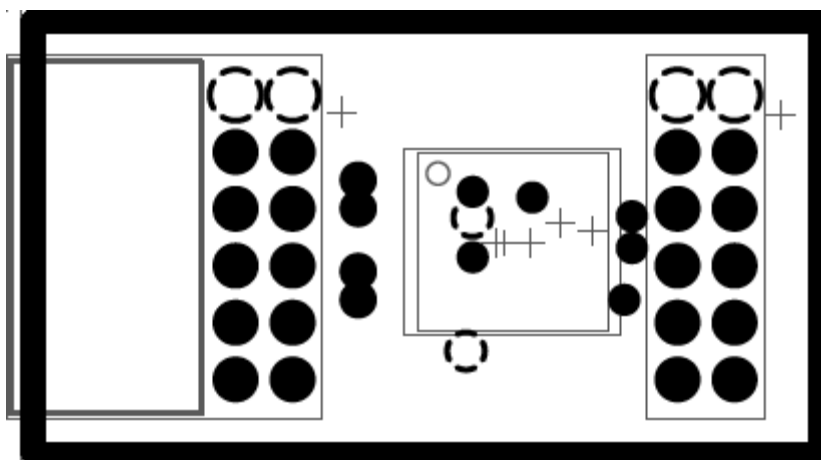

Figure 7. Copper L1 Layer

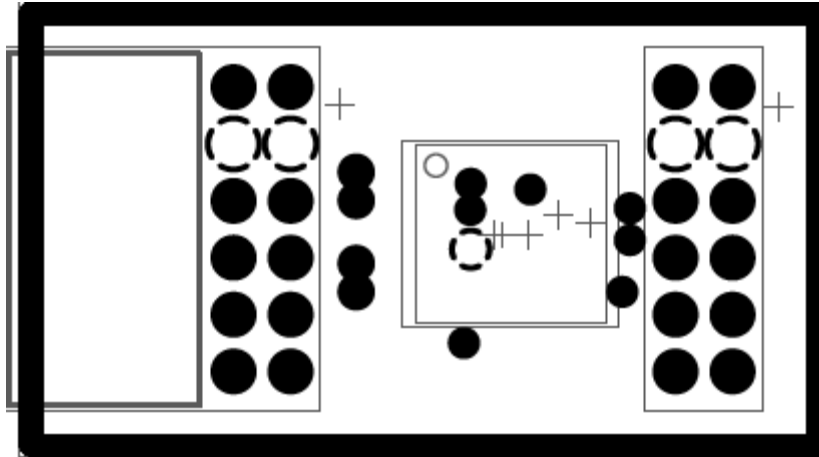

Figure 8. Copper L2 Layer

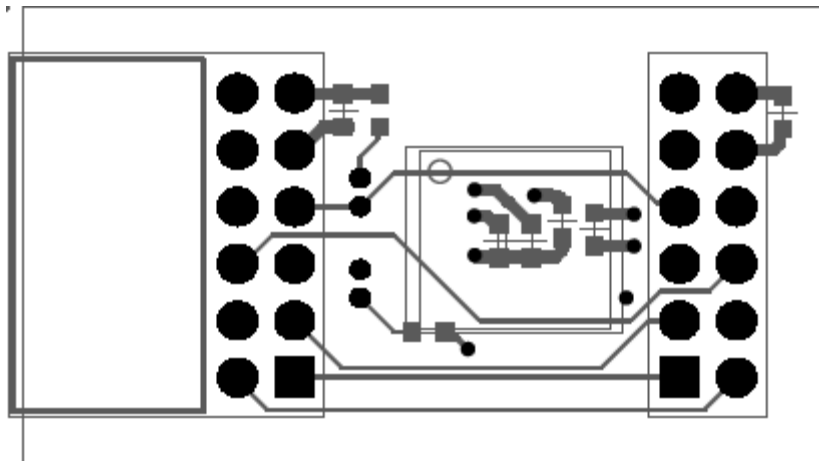

Figure 9. Copper Bottom

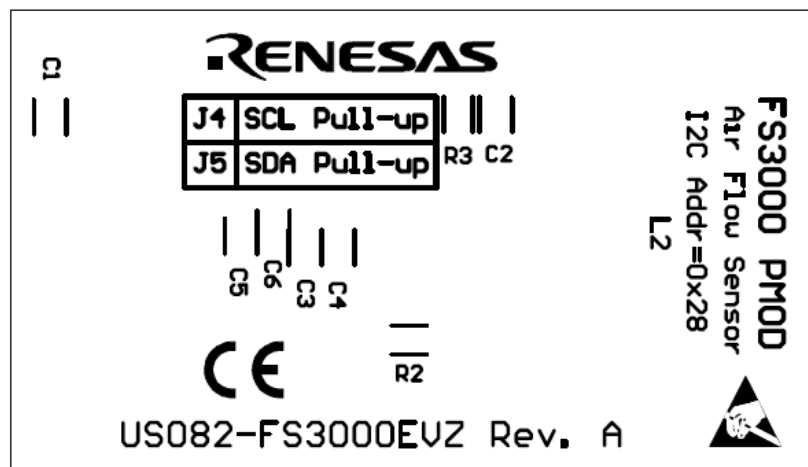

Figure 10. Silkscreen Bottom

4. Ordering Information

Part Number	Description
US082-FS3000EVZ	FS3000 Pmod Board
US082-INTERPEVZ	Pmod interposer board to convert Type 2A and 3A to Type 6A on older Renesas MCU kits.

5. Revision History

Revision	Date	Description
1.00	Jul 13, 2022	Initial release.