

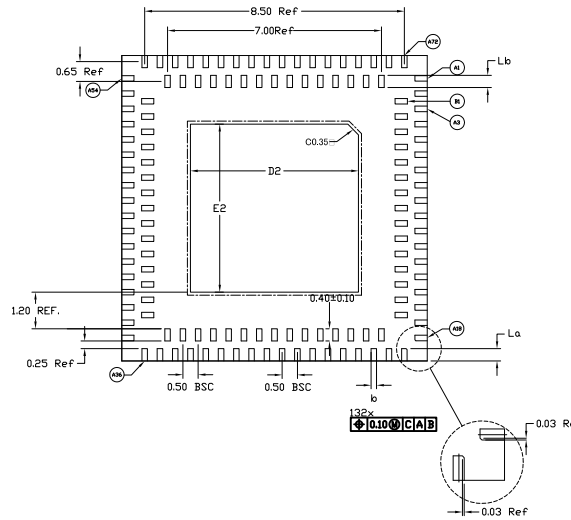

REVISIONS			
REV	DESCRIPTION	DATE	APPROVED
00	INITIAL RELEASE	6/16/16	J.H

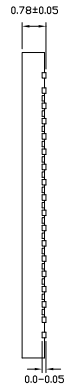

SYMBOL	PITCH VARIATION			NOTE
	MIN.	NOM.	MAX.	
leT	0.50 BSC			
leR	0.65 BSC			
N	132			3
NDa	18			3
NDb	15			3
NEa	18			3
NEb	15			3
La	0.30	0.40	0.50	
Lb	0.30	0.40	0.50	
b	0.17	0.22	0.27	4
D2	5.35	5.50	5.65	
E2	5.35	5.50	5.65	

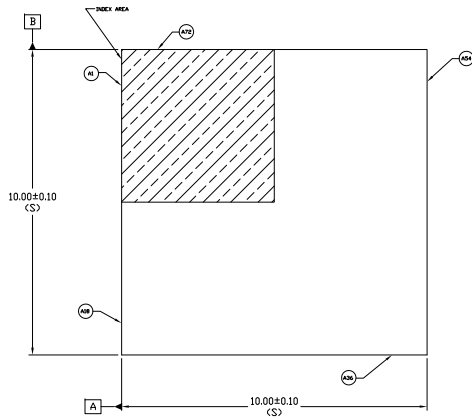
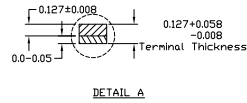
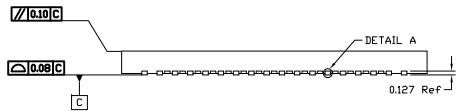

- NOTE:
1. ALL DIMENSION ARE IN mm, ANGLES IN DEGREES
 2. COPLANARITY APPLIES TO THE EXPOSED PAD AS WELL AS THE TERMINALS. COPLANARITY SHALL NOT EXCEED 0.08 mm
 3. WARPAGE SHALL NOT EXCEED 0.10.
 4. PACKAGE LENGTH/PACKAGE WIDTH ARE CONSIDERD AS SPECIAL CHARACTERIS (S)

TOLERANCES UNLESS SPECIFIED		 6024 Silver Creek Valley Road San Jose, CA 95138 PHONE: (408) 284-8200 FAX: (408) 284-8591 www.IDT.com
DECIMAL	ANGULAR	
X±		TITLE NQ/NQG132 PACKAGE OUTLINE 10.0 x 10.0 mm BODY, EPAD 5.50mm SQ. 0.50mm Pitch Dual-Row QFN
XX±		
XXX±		
APPROVALS	DATE	
DRAWN <i>JP</i>	07/10/07	
CHECKED		
	SIZE	DRAWING No.
	C	PSC-4327-02
		REV
		00
DO NOT SCALE DRAWING		SHEET 1 OF 2

REVISIONS			
REV	DESCRIPTION	DATE	APPROVED
00	INITIAL RELEASE	6/16/16	J.H

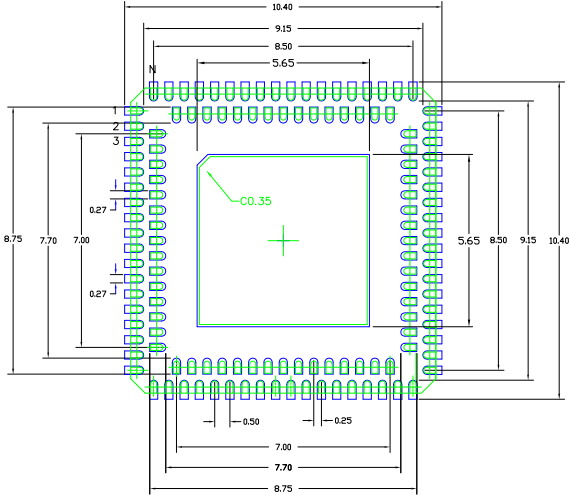

RECOMMENDED LAND PATTERN

NOTE:

1. ALL DIMENSIONS ARE IN mm. ANGLES IN DEGREES.
2. TOP DOWN VIEW, AS VIEWED ON PCB.
3. COMPONENT OUTLINE SHOWS FOR REFERENCE IN GREEN.
4. LAND PATTERN IN BLUE. NSMD PATTERN ASSUMED.
5. LAND PATTERN RECOMMENDATION PER IPC-7351B GENERIC REQUIREMENT FOR SURFACE MOUNT DESIGN AND LAND PATTERN.

TOLERANCES UNLESS SPECIFIED		 IDT™ 6024 Silver Creek Valley Road San Jose, CA 95138 PHONE: (408) 284-8200 www.IDT.com FAX: (408) 284-8591		
DECIMAL	ANGULAR			
X±		APPROVALS DATE TITLE NQ/NQG132 PACKAGE OUTLINE DRAWN <i>BP</i> 07/10/07 10.0 x 10.0 mm BODY, EPAD 5.50mm SQ. CHECKED 0.50mm Pitch Dual-Row QFN		
XX±				
XXX±		SIZE	DRAWING No.	REV
		C	PSC-4327-02	00
DO NOT SCALE DRAWING			SHEET 2 OF 2	