

100-PIN PLASTIC QFP (STRAIGHT) (14x20)

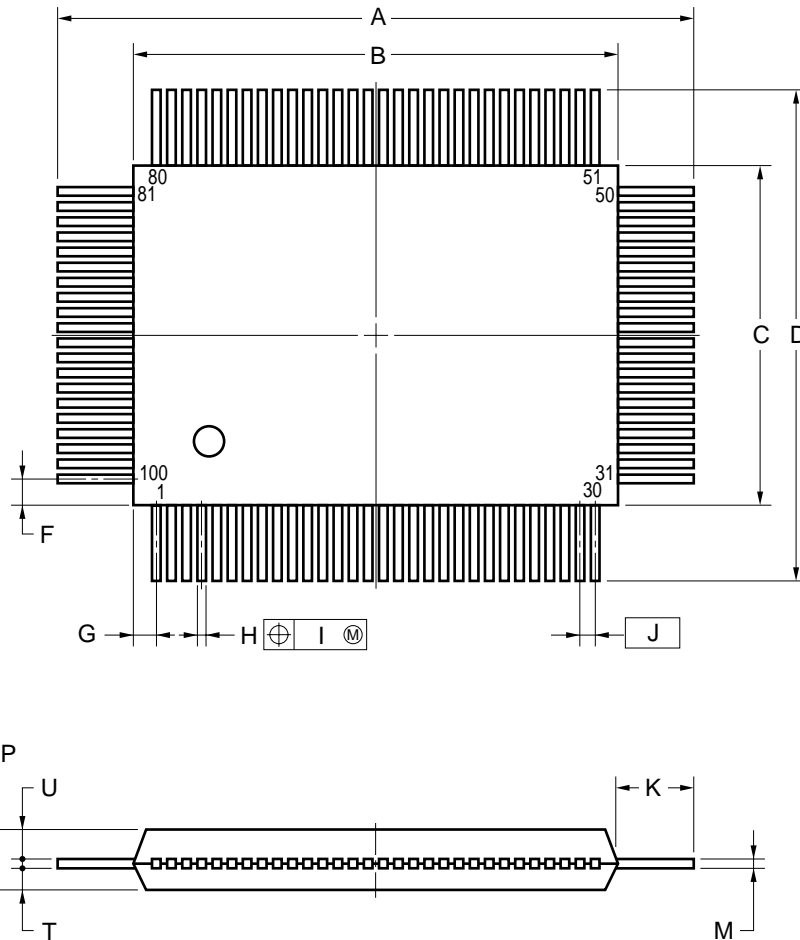

NOTE

Each lead centerline is located within 0.15 mm of its true position (T.P.) at maximum material condition.

ITEM	MILLIMETERS
A	25.6±0.4
B	20.0±0.2
C	14.0±0.2
D	19.6±0.4
F	0.8
G	0.6
H	0.30±0.10
I	0.15
J	0.65 (T.P.)
K	2.8±0.2
M	0.15 ^{+0.10} _{-0.05}
P	2.05 ^{+0.2} _{-0.1}
T	0.8
U	1.1

P100G-65-11-3