

56-PIN FBGA(WAFER LEVEL BGA)(3.96x3.56)

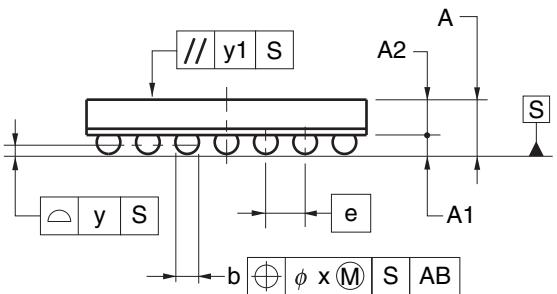
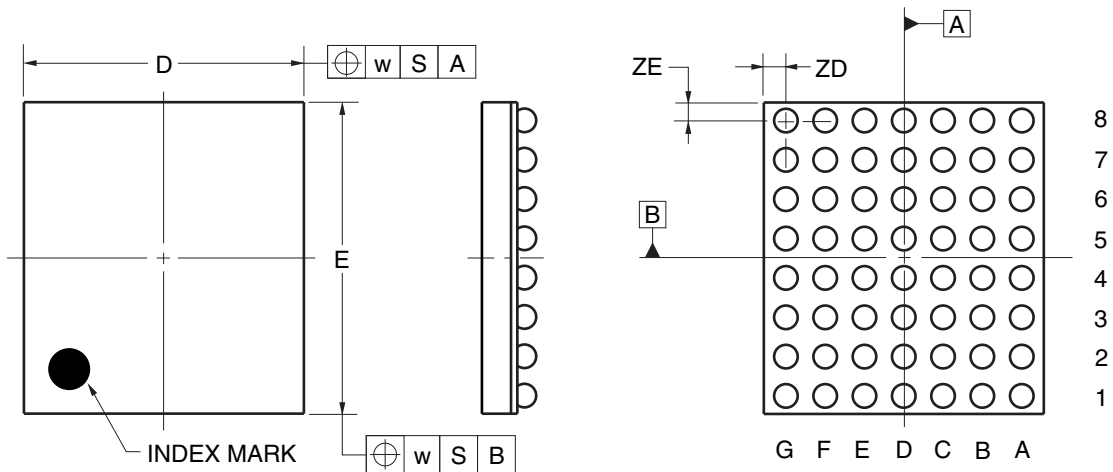

(UNIT:mm)

ITEM	DIMENSIONS
D	3.56±0.05
E	3.96±0.05
w	0.05
A	0.69±0.06
A1	0.24±0.05
A2	0.45
e	0.50
b	0.31±0.05
x	0.05
y	0.08
y1	0.20
ZD	0.28
ZE	0.23

P56FH-50-AA2