

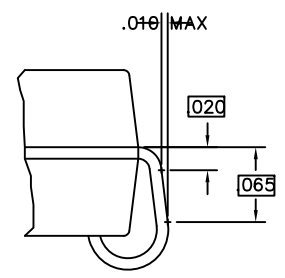

DATE CREATED		REVISIONS		
REV	DESCRIPTION	AUTHOR		
07	ADD "GREEN" PLG NOMENCALTURE	TU VU		
08	ADD "20L"	JH		

NOTE: REFER TO DCP FOR OFFICIAL RELEASE DATE

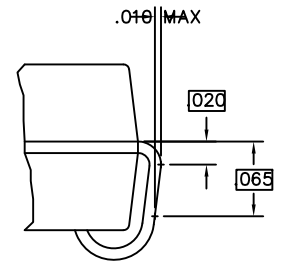
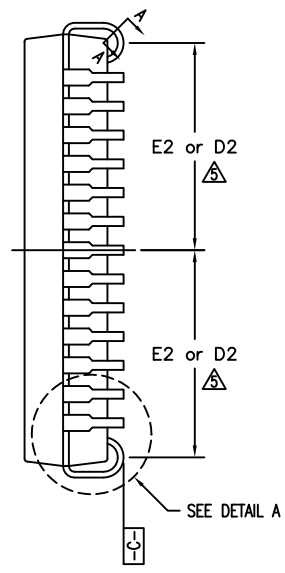
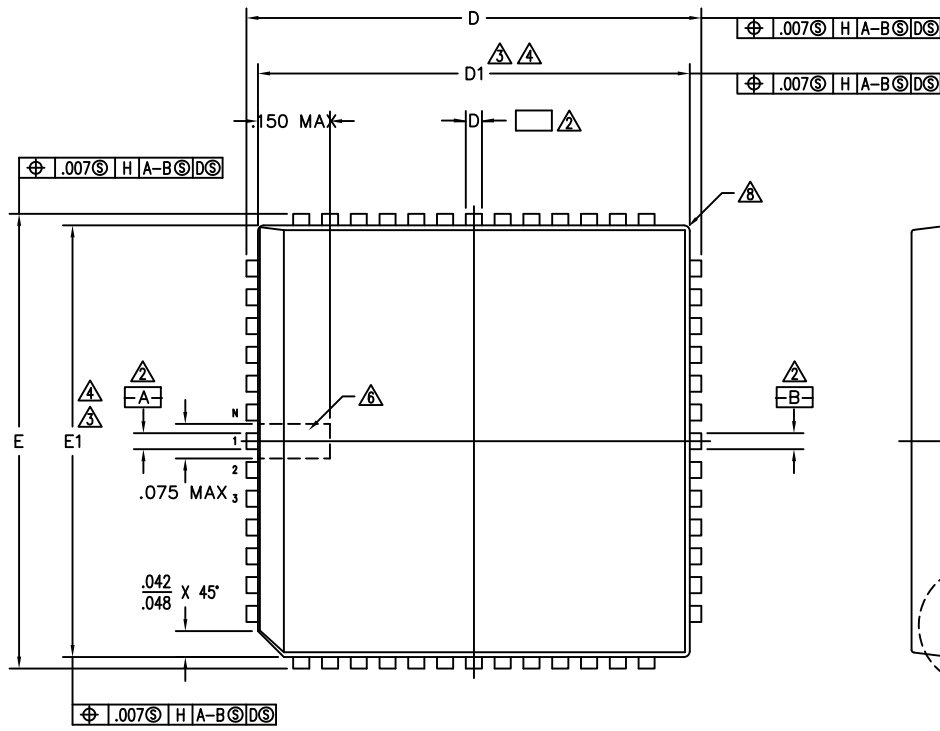
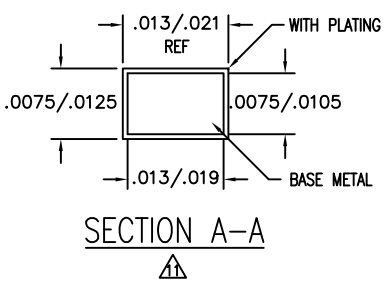
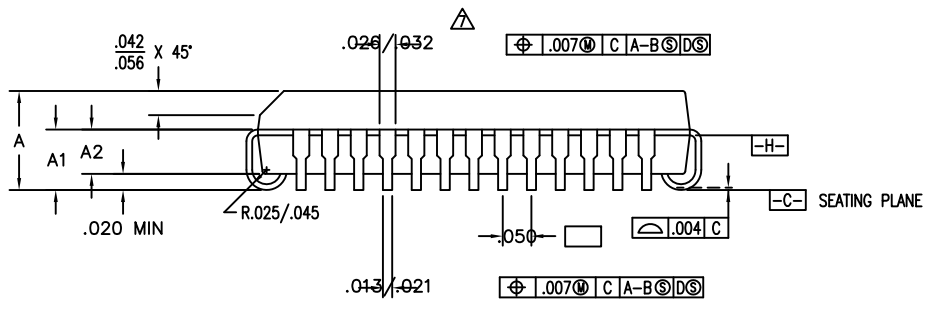

DETAIL A



TOLERANCES UNLESS SPECIFIED		 2975 Stender Way Santa Clara, CA 95054 PHONE: (408) 727-6116 FAX: (408) 492-8674 www.IDT.com
DECIMAL	ANGULAR	
XXX±	±	
XXXX±		
APPROVALS	DATE	TITLE
		PL/PLG PACKAGE OUTLINE SQUARE PLCC .050 PITCH
SIZE	DRAWING No.	REV
C	PSC-4008	08
DO NOT SCALE DRAWING		SHEET 1 OF 3

DATE		REVISIONS		
CREATED	REV	DESCRIPTION	AUTHOR	
11/11/04	07	ADD "GREEN" PLG NOMENCALTURE	TU VU	
9/26/17	08	ADD "20L"	JH	
NOTE: REFER TO DCP FOR OFFICIAL RELEASE DATE				

SYMBOL	JEDEC VARIATION			NOTE	SYMBOL	JEDEC VARIATION			NOTE	SYMBOL	JEDEC VARIATION			NOTE	SYMBOL	JEDEC VARIATION			NOTE	SYMBOL	JEDEC VARIATION			NOTE					
	AB					AB					AC					AD					AE				AF				
	MIN	NOM	MAX			MIN	NOM	MAX			MIN	NOM	MAX			MIN	NOM	MAX			MIN	NOM	MAX		MIN	NOM	MAX	MIN	NOM
A	.165	.172	.180		A	.165	.172	.180		A	.165	.172	.180		A	.165	.172	.180		A	.165	.172	.180						
A1	.090	.105	.120		A1	.095	.105	.115		A1	.095	.105	.115		A1	.095	.105	.115		A1	.095	.105	.115						
A2	.062	-	.083		A2	.062	-	.083		A2	.062	-	.083		A2	.062	-	.083		A2	.059	-	.080						
D	.385	.390	.395		D	.485	.490	.495		D	.685	.690	.695		D	.785	.790	.795		D	.985	.990	.995						
D1	.350	.353	.356	3,4	D1	.450	.453	.456	3,4	D1	.650	.653	.656	3,4	D1	.750	.753	.756	3,4	D1	.950	.953	.956	3,4					
D2	.158	.168	.178	5	D2	.195	.205	.215	5	D2	.295	.305	.315	5	D2	.345	.355	.365	5	D2	.445	.455	.465	5					
E	.385	.390	.395		E	.485	.490	.495		E	.685	.690	.695		E	.785	.790	.795		E	.985	.990	.995						
E1	.350	.353	.356	3,4	E1	.450	.453	.456	3,4	E1	.650	.653	.656	3,4	E1	.750	.753	.756	3,4	E1	.950	.953	.956	3,4					
E2	.158	.168	.178	5	E2	.191	.205	.219	5	E2	.291	.305	.319	5	E2	.341	.355	.369	5	E2	.441	.455	.469	5					
N	20				N	28				N	44				N	52				N	68				N	84			

NOTES:

- 1 ALL DIMENSIONING AND TOLERANCING CONFORM TO ANSI Y14.5M-1982
- 2 DATUMS [A-B] AND [-D-] TO BE DETERMINED AT DATUM PLANE [-H-]
- 3 DIMENSIONS D1 AND E1 ARE TO BE DETERMINED AT DATUM PLANE [-H-]
- 4 DIMENSIONS D1 AND E1 DO NOT INCLUDE MOLD PROTRUSION. ALLOWABLE MOLD PROTRUSION IS .010 PER SIDE. D1 AND E1 ARE BODY SIZE DIMENSIONS INCLUDING MOLD MISMATCH
- 5 DIMENSIONS D2 AND E2 ARE TO BE DETERMINED AT SEATING PLANE [-C-] CONTACT POINT
- 6 DETAIL OF PIN 1 IDENTIFIER IS OPTIONAL BUT MUST BE LOCATED WITHIN THE ZONE INDICATED
- 7 LEAD WIDTH DIMENSION DOES NOT INCLUDE DAMBAR PROTRUSION. ALLOWABLE DAMBAR PROTRUSION IS .007 TOTAL MAXIMUM PER LEAD
- 8 EXACT SHAPE OF EACH CORNER IS OPTIONAL
- 9 THESE DIMENSIONS DETERMINE THE MAXIMUM ANGLE OF THE LEAD FOR SOCKET APPLICATIONS
- 10 ALL DIMENSIONS ARE IN INCHES
- 11 THIS OUTLINE CONFORMS TO JEDEC PUBLICATION 95 REGISTRATION MS-018, VARIATION AB, AC, AD, AE & AF. EXCEPTIONS: JEDEC MAXIMUM BASE METAL LEAD WIDTH IS .018

TOLERANCES UNLESS SPECIFIED		 2975 Stender Way Santa Clara, CA 95054 PHONE: (408) 727-6116 FAX: (408) 492-8674
DECIMAL	ANGULAR	
XX±	±	www.IDT.com
XXX±		TITLE PL/PLG PACKAGE OUTLINE
XXXX±		SQUARE PLCC
		.050 PITCH
SIZE	DRAWING No.	REV
C	PSC-4008	08
DO NOT SCALE DRAWING		SHEET 2 OF 3

DATE		REVISIONS		
CREATED	REV	DESCRIPTION	AUTHOR	
11/11/04	07	ADD "GREEN" PLG NOMENCALTURE	TU VU	
9/26/17	08	ADD "20L"	JH	
NOTE: REFER TO DCP FOR OFFICIAL RELEASE DATE				

LAND PATTERN DIMENSIONS

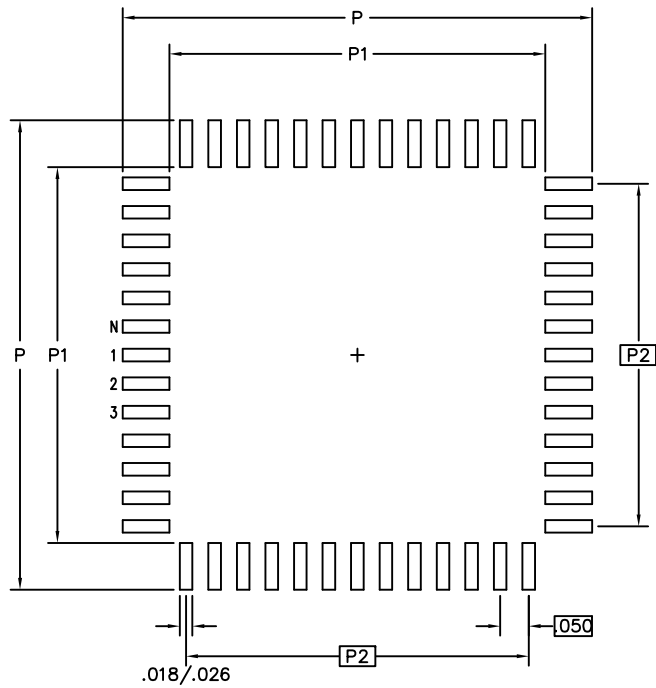

	MIN	MAX	MIN	MAX	MIN	MAX	MIN	MAX	MIN	MAX	MIN	MAX
P	.420	.428	.520	.528	.720	.728	.820	.828	1.020	1.028	1.220	1.228
P1	.254	.266	.354	.362	.554	.562	.654	.662	.854	.862	1.054	1.062
P2	.200 BSC		.300 BSC		.500 BSC		.600 BSC		.800 BSC		1.000 BSC	
N	20		28		44		52		68		84	

TOLERANCES UNLESS SPECIFIED		 IDT™ www.IDT.com	2975 Stender Way Santa Clara, CA 95054	
DECIMAL	ANGULAR		PHONE: (408) 727-6116	
XXX±	±		FAX: (408) 492-8674	
XXXX±				
TITLE			PL/PLG PACKAGE OUTLINE	
			SQUARE PLCC	
			.050 PITCH	
SIZE	DRAWING No.	REV		
C	PSC-4008	08		
DO NOT SCALE DRAWING			SHEET 3 OF 3	