



Neutron testing of the ISL70001SRH POL converter

Nick van Vonno
Intersil Corporation

25 June 2012

Table of Contents

1. Introduction
2. Part Description
3. Test Description
 - 3.1 Irradiation facility
 - 3.2 Characterization equipment
 - 3.3 Experimental Matrix
4. Results
 - 4.1 Test results
 - 4.2 Variables data
5. Discussion and conclusion
6. Appendices
7. Document revision history

1. Introduction

This report summarizes results of neutron testing of the ISL70001SRH point of load converter (POL). The test was conducted in order to determine the sensitivity of the part to the displacement damage caused by the neutron environment.

2: Part Description

The ISL70001SRH is a high efficiency monolithic synchronous buck regulator with integrated power MOSFET devices, eliminating the need for external MOSFET devices. The part is designed for point of load (POL) applications and provides a single chip power management solution for digital ICs such as processors and field programmable gate arrays. The ISL70001SRH is designed and rated for the total dose and SEE environments as encountered in space and is manufactured in compliance with MIL-PRF-38535. The part operates over an input voltage range of 3V to 5.5V and provides a regulated output voltage that is externally adjustable from 0.8V to ~85% of the input voltage. Output load current capacity is 6A for $T_J < +145^{\circ}\text{C}$. The ISL70001SRH utilizes peak current-mode control with integrated compensation and switches at a fixed frequency of 1MHz. The high level of integration provided by integrating the power MOSFET devices makes the ISL70001SRH a good choice to power small form factor applications in space systems. A simplified block diagram of the part is shown in Figure 1.

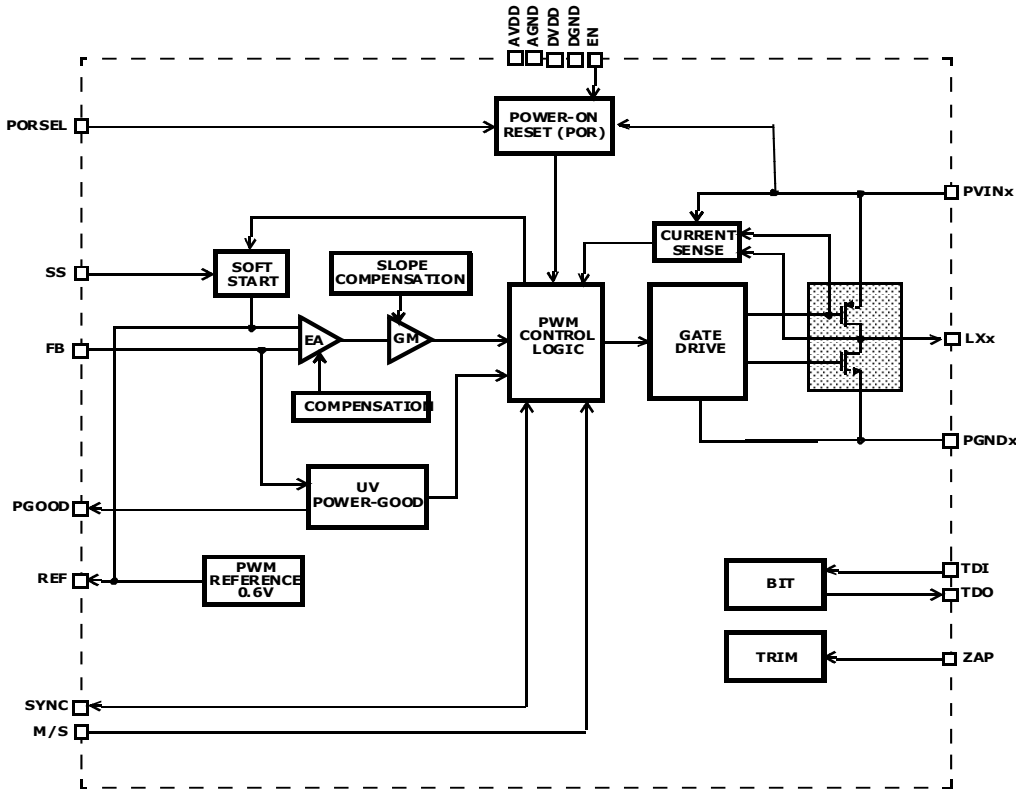

Fig. 1: ISL70001SRH block diagram.

The ISL70001SRH is implemented in a commercial submicron BiCMOS process optimized for power management applications, with 0.6um minimum ground rules and three layers of interconnect. Active devices include low voltage CMOS and high voltage DMOS devices as well as complementary bipolars. The process is in volume production under MIL-PRF-38535 certification and is used for a wide range of commercial power management devices. In order to retain the advantages of volume production, the ISL70001SRH was designed for total dose and SEE hardness using well-known ‘hardened by design’ techniques, including closed geometry N-channel devices, guard rings and latchup-prevention layout design.

3: Test Description

3.1 Irradiation Facilities

Neutron irradiation was performed at the Fast Burst Reactor facility at White Sands Missile Range (White Sands, NM), which provides a controlled 1MeV equivalent neutron flux. Parts were tested in an unbiased configuration with all leads open. As neutron irradiation activates many of the elements found in a packaged integrated circuit, the parts exposed at the higher neutron levels required significant ‘cooldown time’ before being shipped back to Palm Bay for electrical testing.

3.2 Characterization equipment and procedures

Electrical testing was performed before and after irradiation using the production automated test equipment (ATE). All electrical testing was performed at room temperature. Final data was taken 2 September 2011.



3.3 Experimental matrix

Testing proceeded in accordance with the guidelines of MIL-STD-883 Test Method 1017. The experimental matrix consisted of five samples irradiated at 2×10^{12} n/cm², five samples irradiated at 1×10^{13} n/cm², five samples irradiated at 3×10^{13} n/cm² and five samples irradiated at 1×10^{14} n/cm². Three control units were used.

5962R0922502VXC samples were drawn from lot number I2K14H01YGD (P6 BiMOS) and were packaged in 48-lead flatpacks, code RKU. The date code was X1008ABB5, and the mask number for lot I2K14H01YGD was 53695A01. The lot was processed at the IBM Burlington, Vermont facility. Table 1, below, shows sample serial numbers for each experimental cell.

WSMR shot ID	Exposure level	Serial numbers
DTR-11094	2×10^{12}	1207, 1208, 1210, 1234, 1235
DTR-11097	1×10^{13}	1336, 1238, 1239, 1241, 1242
DTR-11100	3×10^{13}	1244, 1247, 1250, 1263, 1264
DTR-11103	1×10^{14}	1265, 1266, 1267, 1268, 1269
Control units		1270, 1272, 1274

Table 1: Neutron irradiation experimental matrix.

4: Results

4.1 Test results

Neutron testing of the ISL70001SRH is complete and the results are reported in the balance of this report.

4.2 Variables data

The plots in Figs. 2 through 46 show data plots for key parameters before and after irradiation to each level. The plots show the median as a function of neutron irradiation; we chose to use the median because of the relatively small sample sizes involved.

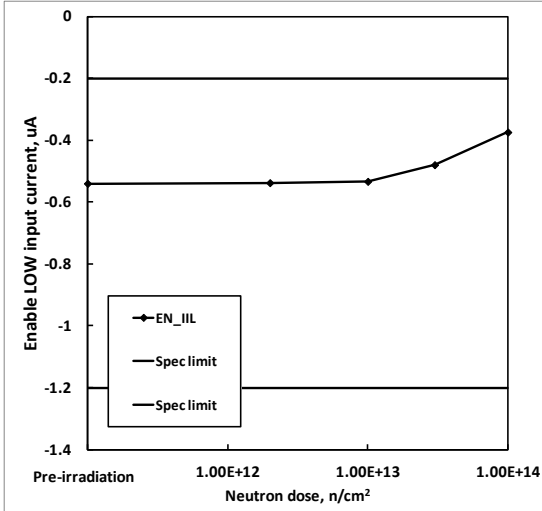

Fig. 2: ISL70001SRH enable LOW input current as a function of neutron irradiation. Sample size was 5 for each cell (2×10^{12} n/cm², 1×10^{13} n/cm², 3×10^{13} n/cm² and 1×10^{14} n/cm²), with three control units. The data sheet limits are -1.2uA to -0.2uA.

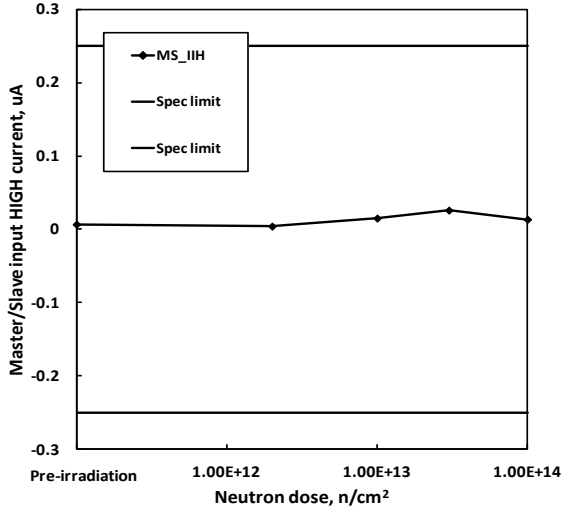

Fig. 4: ISL70001SRH master/slave control pin HIGH input current as a function of neutron irradiation. Sample size was 5 for each cell (2×10^{12} n/cm², 1×10^{13} n/cm², 3×10^{13} n/cm² and 1×10^{14} n/cm²), with three control units. The data sheet limits are -0.25uA to +0.25uA.

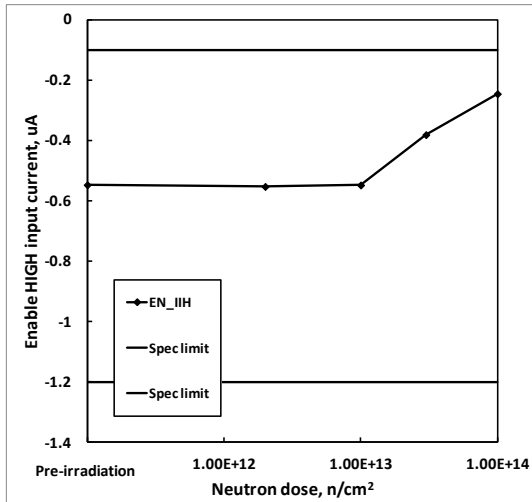

Fig. 3: ISL70001SRH enable HIGH input current as a function of neutron irradiation. Sample size was 5 for each cell (2×10^{12} n/cm², 1×10^{13} n/cm², 3×10^{13} n/cm² and 1×10^{14} n/cm²), with three control units. The data sheet limits are -1.2uA to -0.1uA.

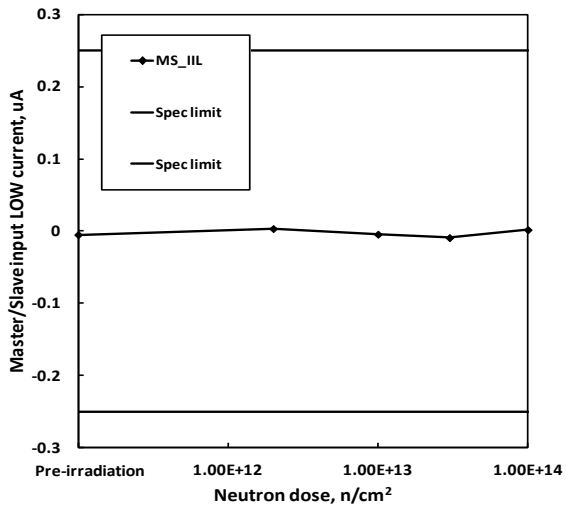

Fig. 5: ISL70001SRH master/slave control pin LOW input current as a function of neutron irradiation. Sample size was 5 for each cell (2×10^{12} n/cm², 1×10^{13} n/cm², 3×10^{13} n/cm² and 1×10^{14} n/cm²), with three control units. The data sheet limits are -0.25uA to +0.25uA.

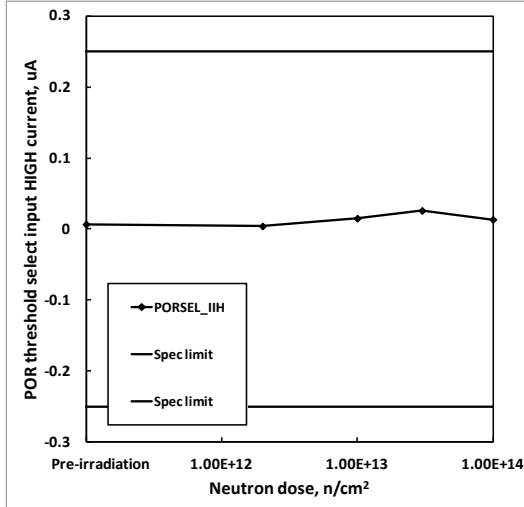

Fig. 6: ISL70001SRH POR threshold select HIGH input current as a function of neutron irradiation. Sample size was 5 for each cell (2×10^{12} n/cm², 1×10^{13} n/cm², 3×10^{13} n/cm² and 1×10^{14} n/cm²), with three control units. The data sheet limits are -0.25uA to +0.25uA.

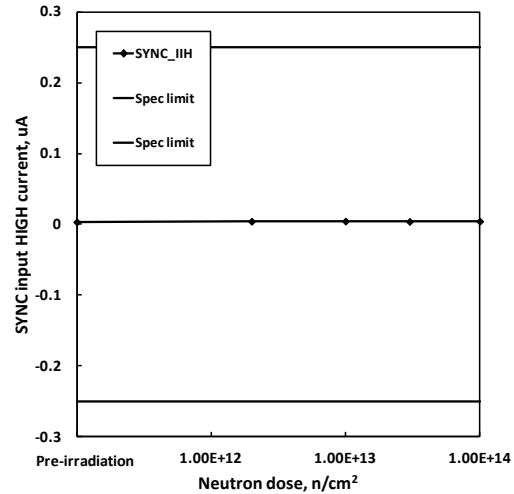

Fig. 8: ISL70001SRH SYNC input pin HIGH input current as a function of neutron irradiation. Sample size was 5 for each cell (2×10^{12} n/cm², 1×10^{13} n/cm², 3×10^{13} n/cm² and 1×10^{14} n/cm²), with three control units. The data sheet limits are -0.25uA to +0.25uA.

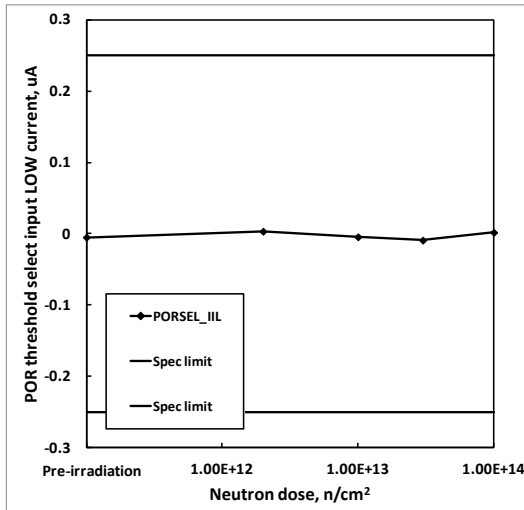

Fig. 7: ISL70001SRH POR threshold select LOW input current as a function of neutron irradiation. Sample size was 5 for each cell (2×10^{12} n/cm², 1×10^{13} n/cm², 3×10^{13} n/cm² and 1×10^{14} n/cm²), with three control units. The data sheet limits are -0.25uA to +0.25uA.

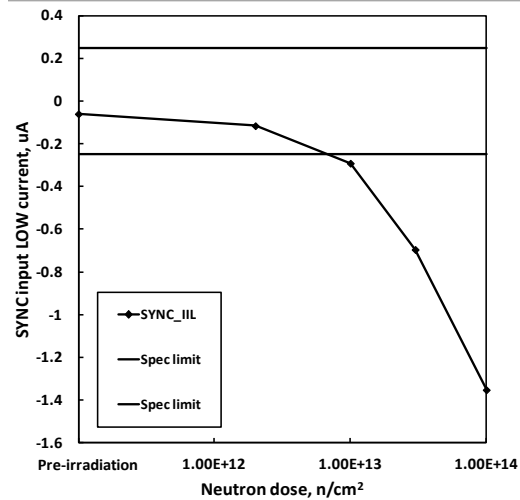

Fig. 9: ISL70001SRH SYNC input pin LOW input current as a function of neutron irradiation. Sample size was 5 for each cell (2×10^{12} n/cm², 1×10^{13} n/cm², 3×10^{13} n/cm² and 1×10^{14} n/cm²), with three control units. The data sheet limits are -0.25uA to +0.25uA.

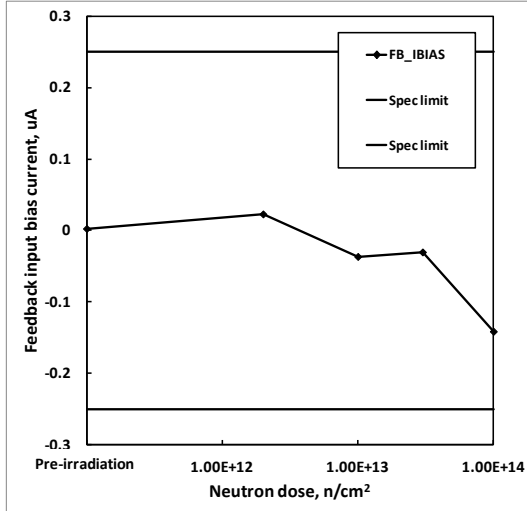

Fig. 10: ISL70001SRH feedback input bias current as a function of neutron irradiation. Sample size was 5 for each cell (2×10^{12} n/cm², 1×10^{13} n/cm², 3×10^{13} n/cm² and 1×10^{14} n/cm²), with three control units. The data sheet limits are -0.25uA to +0.25uA.

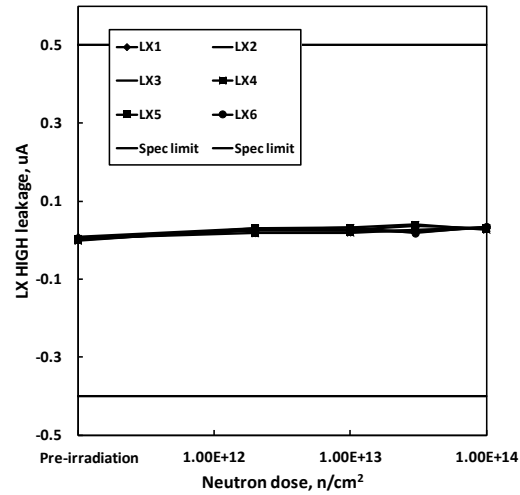

Fig. 12: ISL70001SRH LX HIGH leakage current, all six LX outputs, as a function of neutron irradiation. Sample size was 5 for each cell (2×10^{12} n/cm², 1×10^{13} n/cm², 3×10^{13} n/cm² and 1×10^{14} n/cm²), with three control units. The data sheet limits are -0.4uA to +0.5uA.

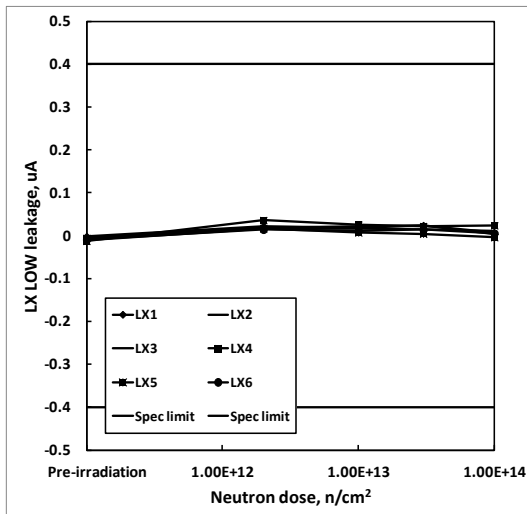

Fig. 11: ISL70001SRH LX LOW leakage current, all six LX outputs, as a function of neutron irradiation. Sample size was 5 for each cell (2×10^{12} n/cm², 1×10^{13} n/cm², 3×10^{13} n/cm² and 1×10^{14} n/cm²), with three control units. The data sheet limits are -0.4uA to +0.4uA.

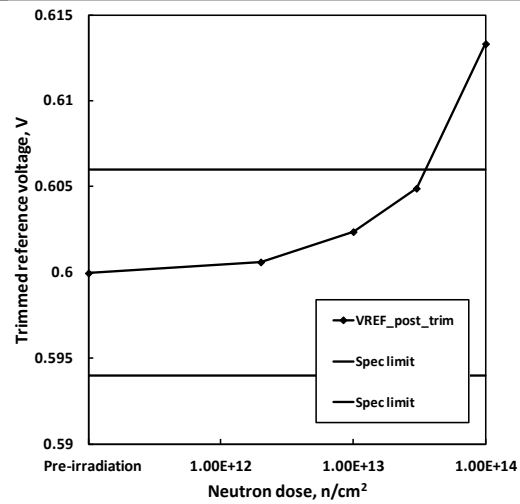

Fig. 13: ISL70001SRH trimmed reference voltage as a function of neutron irradiation. Sample size was 5 for each cell (2×10^{12} n/cm², 1×10^{13} n/cm², 3×10^{13} n/cm² and 1×10^{14} n/cm²), with three control units. The data sheet limits are 0.594V to 0.606V.

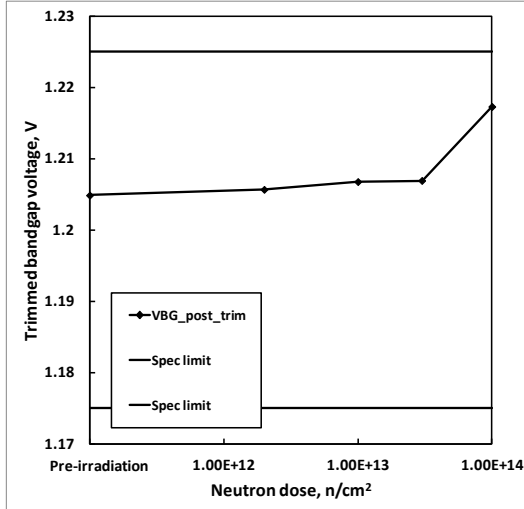

Fig. 14: ISL70001SRH trimmed bandgap voltage as a function of neutron irradiation. Sample size was 5 for each cell (2×10^{12} n/cm², 1×10^{13} n/cm², 3×10^{13} n/cm² and 1×10^{14} n/cm²), with three control units. The data sheet limits are 1.175V to 1.225V.

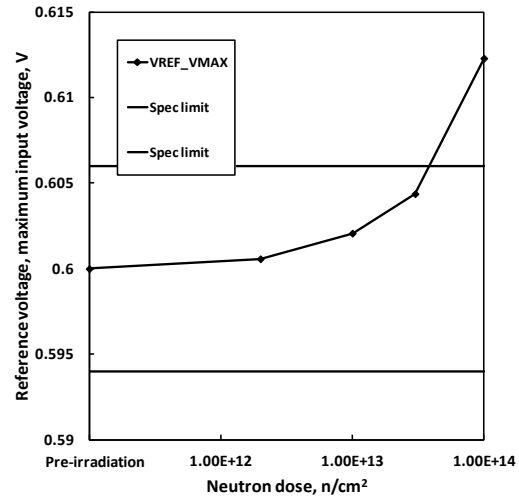

Fig. 16: ISL70001SRH reference output voltage, 5.5V in, as a function of neutron irradiation. Sample size was 5 for each cell (2×10^{12} n/cm², 1×10^{13} n/cm², 3×10^{13} n/cm² and 1×10^{14} n/cm²), with three control units. The data sheet limits are 0.594V to 0.606V.

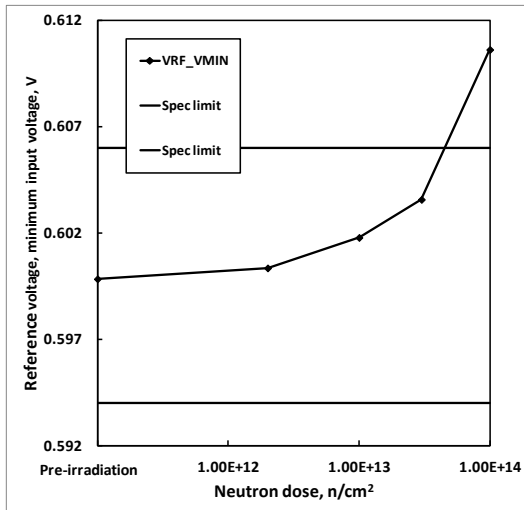

Fig. 15: ISL70001SRH reference output voltage, 3.6V in, as a function of neutron irradiation. Sample size was 5 for each cell (2×10^{12} n/cm², 1×10^{13} n/cm², 3×10^{13} n/cm² and 1×10^{14} n/cm²), with three control units. The data sheet limits are 0.594V to 0.606V.

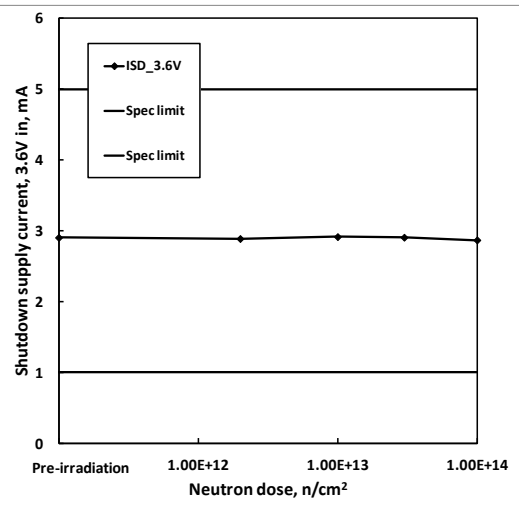

Fig. 17: ISL70001SRH shutdown supply current, 3.6V in, as a function of neutron irradiation. Sample size was 5 for each cell (2×10^{12} n/cm², 1×10^{13} n/cm², 3×10^{13} n/cm² and 1×10^{14} n/cm²), with three control units. The data sheet limits are 1.0mA to 5.0mA.

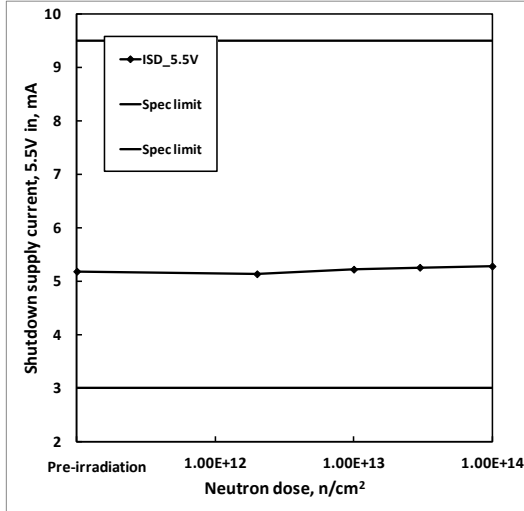

Fig. 18: ISL70001SRH shutdown supply current, 5.5V in, as a function of neutron irradiation. Sample size was 5 for each cell (2×10^{12} n/cm², 1×10^{13} n/cm², 3×10^{13} n/cm² and 1×10^{14} n/cm²), with three control units. The data sheet limits are 3.0mA to 9.5mA.

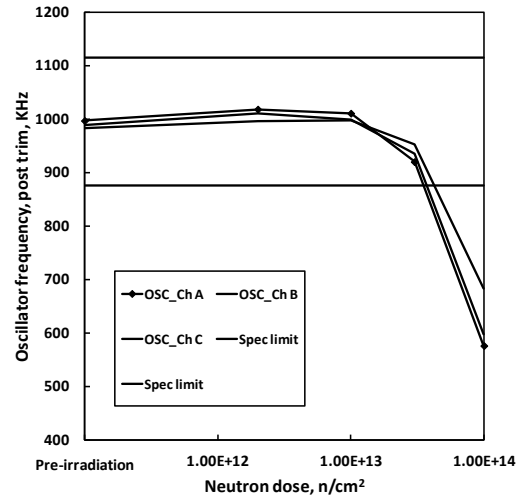

Fig. 20: ISL70001SRH oscillator frequency, all three channels, as a function of neutron irradiation. Sample size was 5 for each cell (2×10^{12} n/cm², 1×10^{13} n/cm², 3×10^{13} n/cm² and 1×10^{14} n/cm²), with three control units. The data sheet limits are 875KHz to 1125KHz.

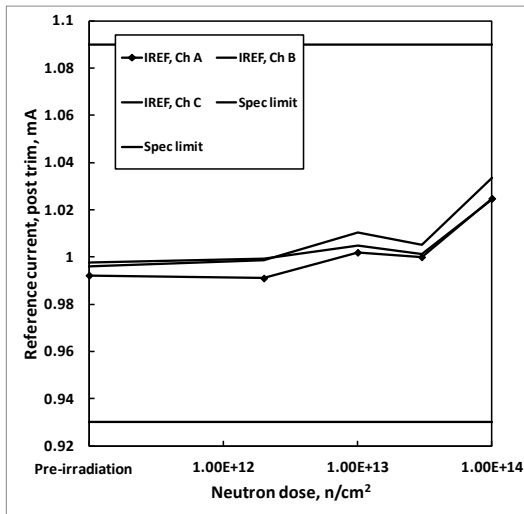

Fig. 19: ISL70001SRH post trim reference current as a function of neutron irradiation. Sample size was 5 for each cell (2×10^{12} n/cm², 1×10^{13} n/cm², 3×10^{13} n/cm² and 1×10^{14} n/cm²), with three control units. The data sheet limits are 0.93mA to 1.09mA.

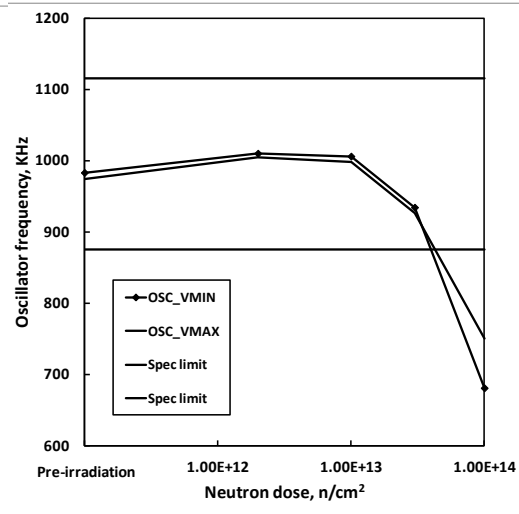

Fig. 21: ISL70001SRH oscillator frequency vs. input voltage as a function of neutron irradiation. Sample size was 5 for each cell (2×10^{12} n/cm², 1×10^{13} n/cm², 3×10^{13} n/cm² and 1×10^{14} n/cm²), with three control units. The data sheet limits are 875KHz to 1125KHz.

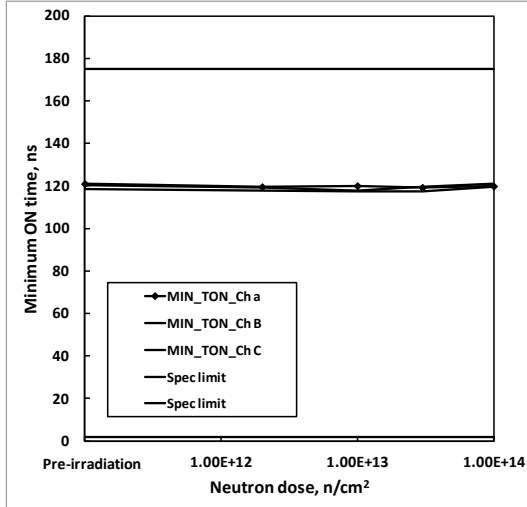

Fig. 22: ISL70001SRH minimum ON time, all three channels, as a function of neutron irradiation. Sample size was 5 for each cell (2×10^{12} n/cm², 1×10^{13} n/cm², 3×10^{13} n/cm² and 1×10^{14} n/cm²), with three control units. The data sheet limit is 175ns maximum..

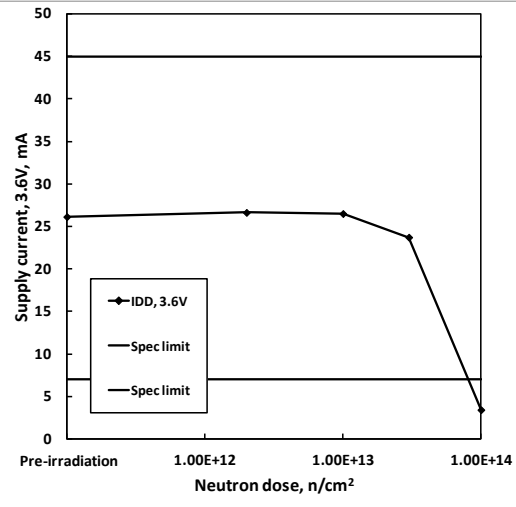

Fig. 24: ISL70001SRH supply current, 3.6V in, as a function of neutron irradiation. Sample size was 5 for each cell (2×10^{12} n/cm², 1×10^{13} n/cm², 3×10^{13} n/cm² and 1×10^{14} n/cm²), with three control units. The data sheet limits are 7.0mA to 45.0mA.

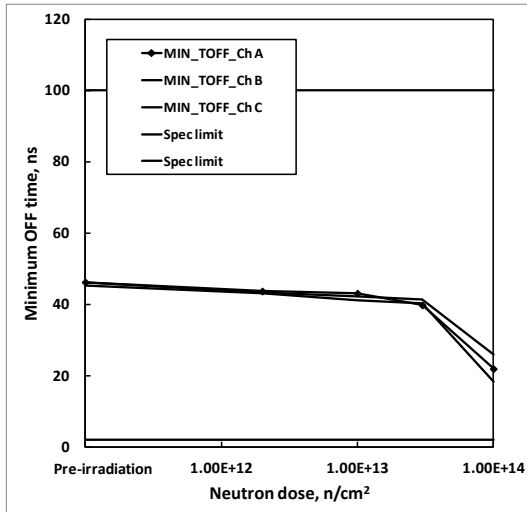

Fig. 23: ISL70001SRH minimum OFF time, all three channels, as a function of neutron irradiation. Sample size was 5 for each cell (2×10^{12} n/cm², 1×10^{13} n/cm², 3×10^{13} n/cm² and 1×10^{14} n/cm²), with three control units. The data sheet limit is 100ns maximum.

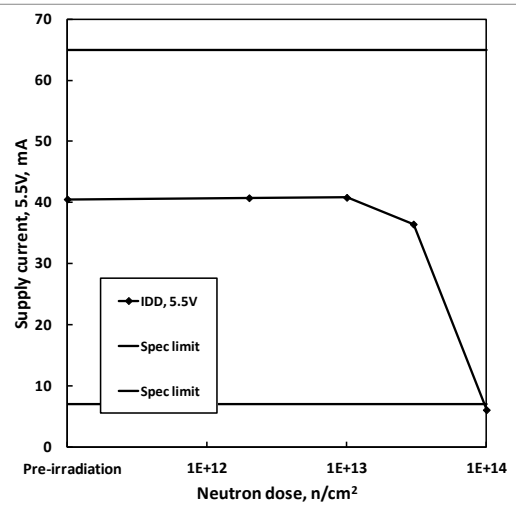

Fig. 25: ISL70001SRH supply current, 5.5V in, as a function of neutron irradiation. Sample size was 5 for each cell (2×10^{12} n/cm², 1×10^{13} n/cm², 3×10^{13} n/cm² and 1×10^{14} n/cm²), with three control units. The data sheet limits are 7.0mA to 65.0mA.

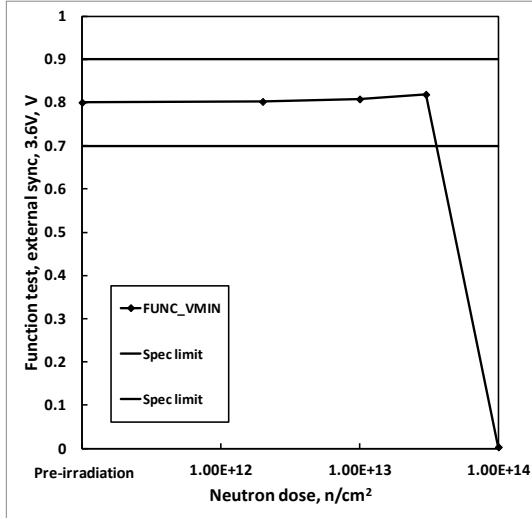

Fig. 26: ISL70001SRH external sync functional test, 3.6V in, as a function of neutron irradiation. Sample size was 5 for each cell (2×10^{12} n/cm², 1×10^{13} n/cm², 3×10^{13} n/cm² and 1×10^{14} n/cm²), with three control units. The data sheet limits are 0.7V to 0.9V.

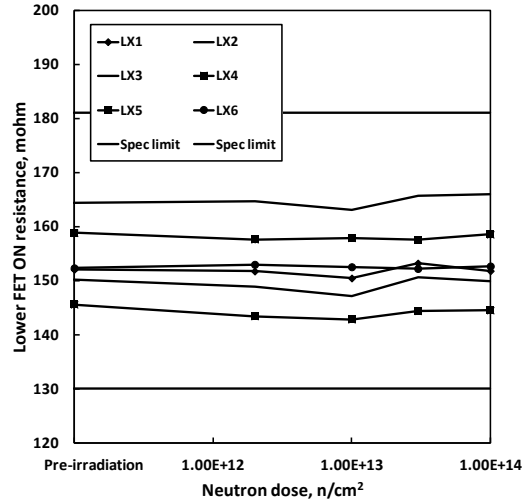

Fig. 28: ISL70001SRH lower FET ON resistance, all six LX blocks, as a function of neutron irradiation. Sample size was 5 for each cell (2×10^{12} n/cm², 1×10^{13} n/cm², 3×10^{13} n/cm² and 1×10^{14} n/cm²), with three control units. The data sheet limits are 130.0mohm to 182.0mohm.

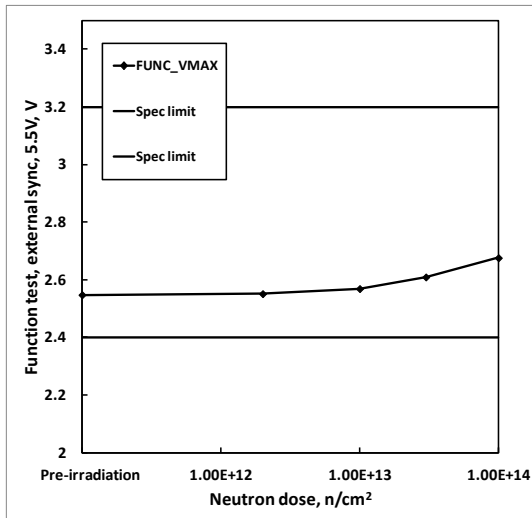

Fig. 27: ISL70001SRH external sync functional test, 5.5V in, as a function of neutron irradiation. Sample size was 5 for each cell (2×10^{12} n/cm², 1×10^{13} n/cm², 3×10^{13} n/cm² and 1×10^{14} n/cm²), with three control units. The data sheet limits are 2.4V to 3.2V.

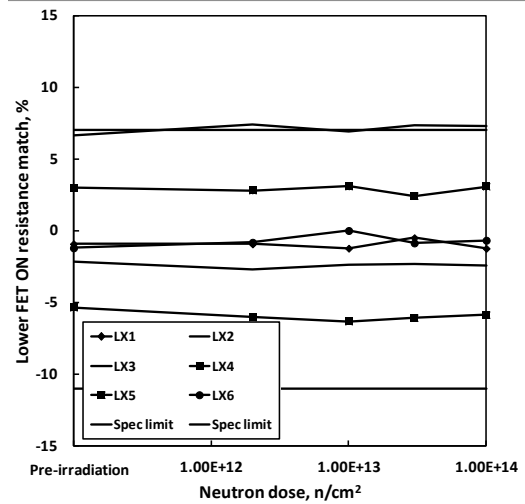

Fig. 29: ISL70001SRH lower FET ON resistance match, all six LX blocks, as a function of neutron irradiation. Sample size was 5 for each cell (2×10^{12} n/cm², 1×10^{13} n/cm², 3×10^{13} n/cm² and 1×10^{14} n/cm²), with three control units. The data sheet limits are -11.0% to +7.0%.

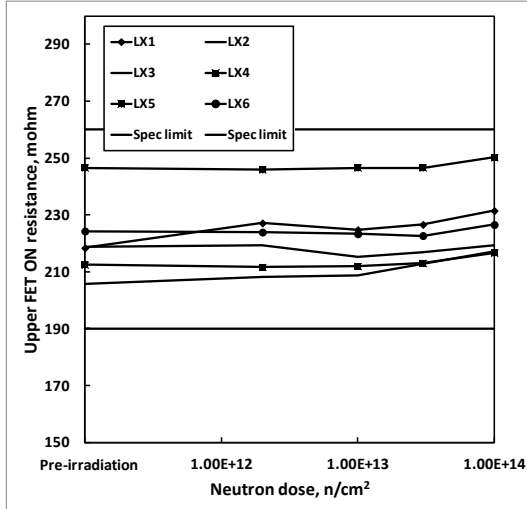

Fig. 30: ISL70001SRH upper FET ON resistance, all six LX blocks, as a function of neutron irradiation. Sample size was 5 for each cell (2×10^{12} n/cm², 1×10^{13} n/cm², 3×10^{13} n/cm² and 1×10^{14} n/cm²), with three control units. The data sheet limits are 190.0mohm to 260.0mohm.

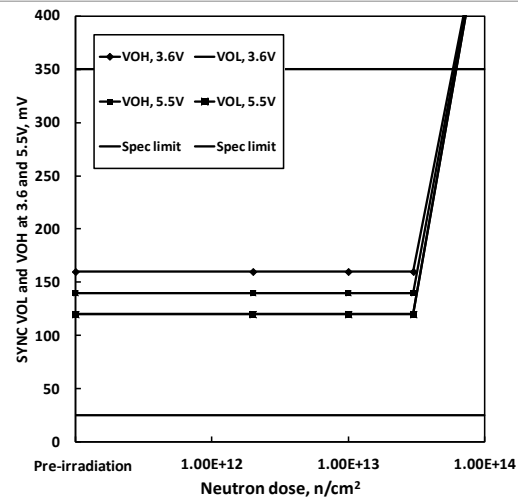

Fig. 32: ISL70001SRH SYNC pin VOL and VOH, 3.6V and 5.5V in, as a function of neutron irradiation. Sample size was 5 for each cell (2×10^{12} n/cm², 1×10^{13} n/cm², 3×10^{13} n/cm² and 1×10^{14} n/cm²), with three control units. The data sheet limits are 25.0mV to 350.0mV.

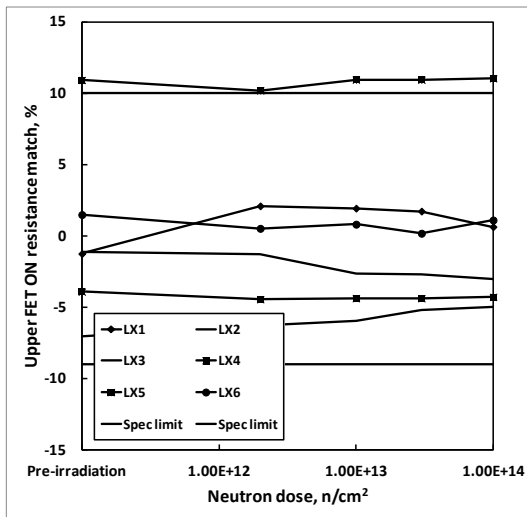

Fig. 31: ISL70001SRH upper FET ON resistance match, all six LX blocks, as a function of neutron irradiation. Sample size was 5 for each cell (2×10^{12} n/cm², 1×10^{13} n/cm², 3×10^{13} n/cm² and 1×10^{14} n/cm²), with three control units. The data sheet limits are -9.0% to +10.0%.

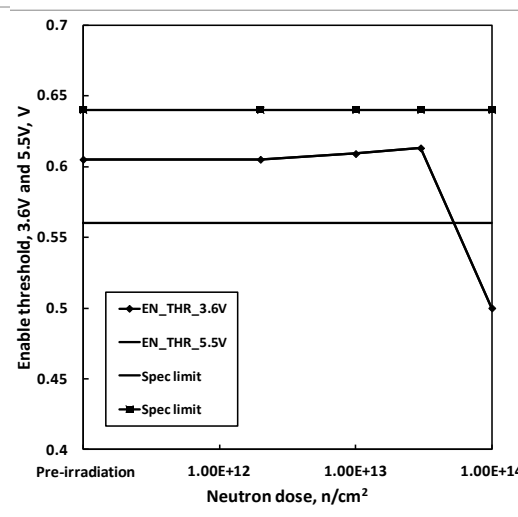

Fig. 33: ISL70001SRH ENABLE threshold, 3.6V and 5.5V in, as a function of neutron irradiation. Sample size was 5 for each cell (2×10^{12} n/cm², 1×10^{13} n/cm², 3×10^{13} n/cm² and 1×10^{14} n/cm²). The data sheet limits are 0.56V to 0.64V.

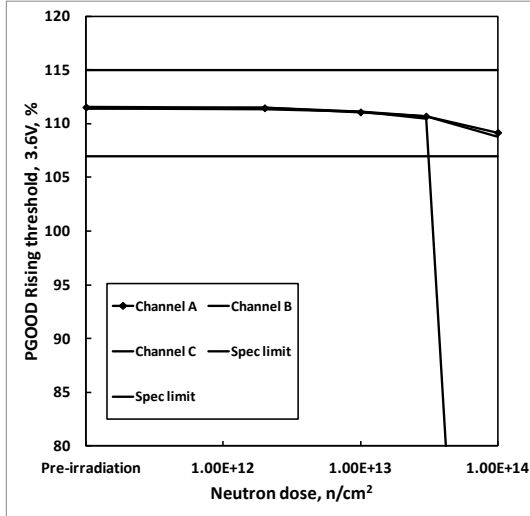

Fig. 34: ISL70001SRH POR Rising threshold, 3.6V and 5.5V in, as a function of neutron irradiation. Sample size was 5 for each cell (2×10^{12} n/cm², 1×10^{13} n/cm², 3×10^{13} n/cm² and 1×10^{14} n/cm²). The data sheet limits are 107.0% to 115.0%.

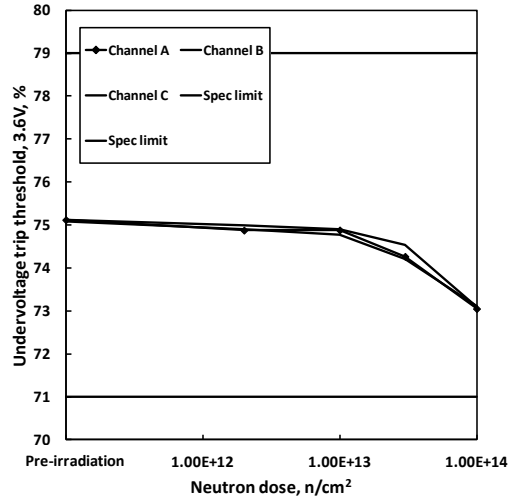

Fig. 36: ISL70001SRH undervoltage trip threshold, all three channels, 3.6V in, as a function of neutron irradiation. Sample size was 5 for each cell (2×10^{12} n/cm², 1×10^{13} n/cm², 3×10^{13} n/cm² and 1×10^{14} n/cm²). The data sheet limits are 71.0% to 79.0%.

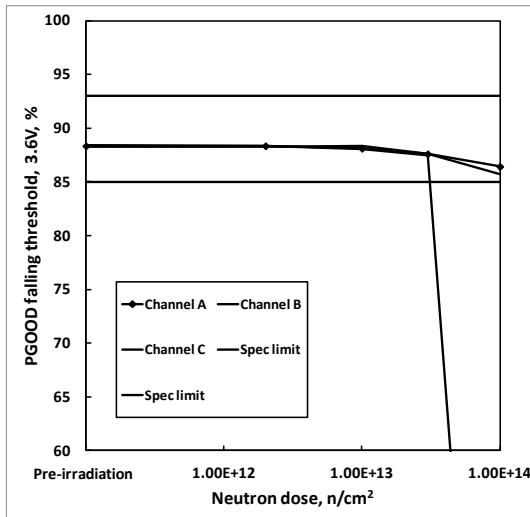

Fig. 35: ISL70001SRH POR Falling threshold, 3.6V and 5.5V in, as a function of neutron irradiation. Sample size was 5 for each cell (2×10^{12} n/cm², 1×10^{13} n/cm², 3×10^{13} n/cm² and 1×10^{14} n/cm²). The data sheet limits are 85.0% to 93.0%.

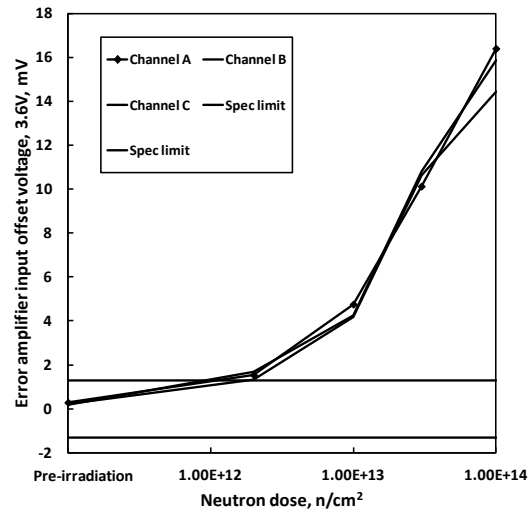

Fig. 37: ISL70001SRH error amplifier input offset voltage, all three channels, 3.6V input, as a function of neutron irradiation. Sample size was 5 for each cell (2×10^{12} n/cm², 1×10^{13} n/cm², 3×10^{13} n/cm² and 1×10^{14} n/cm²). The data sheet limits are -0.8mV to +0.8mV.

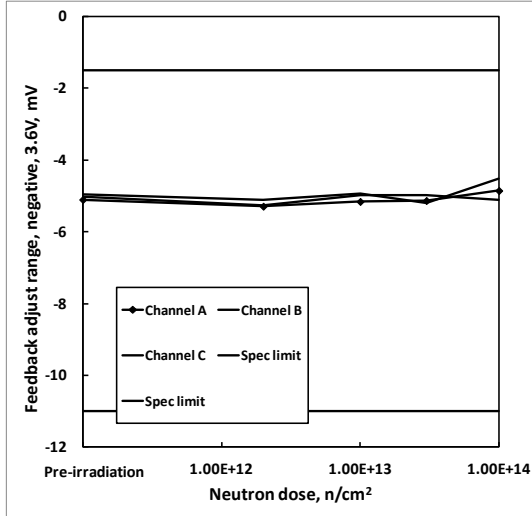

Fig. 38: ISL70001SRH negative feedback adjust range, all three channels, 3.6V in, as a function of neutron irradiation. Sample size was 5 for each cell (2×10^{12} n/cm², 1×10^{13} n/cm², 3×10^{13} n/cm² and 1×10^{14} n/cm²). The data sheet limits are -11.0mV to -1.5mV.

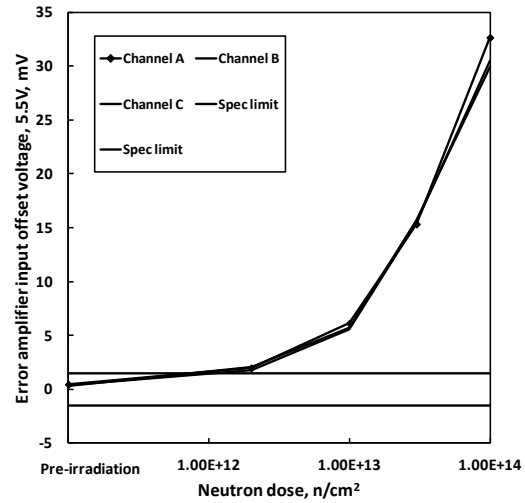

Fig. 40: ISL70001SRH error amplifier input offset voltage, all three channels, 5.5V input, as a function of neutron irradiation. Sample size was 5 for each cell (2×10^{12} n/cm², 1×10^{13} n/cm², 3×10^{13} n/cm² and 1×10^{14} n/cm²). The data sheet limits are -2.0mV to +2.0mV.

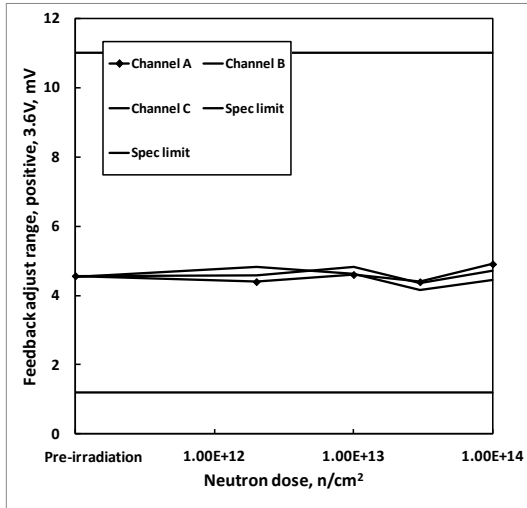

Fig. 39: ISL70001SRH positive feedback adjust range, all three channels, 3.6V in, as a function of neutron irradiation. Sample size was 5 for each cell (2×10^{12} n/cm², 1×10^{13} n/cm², 3×10^{13} n/cm² and 1×10^{14} n/cm²). The data sheet limits are +1.5mV to +11.0mV.

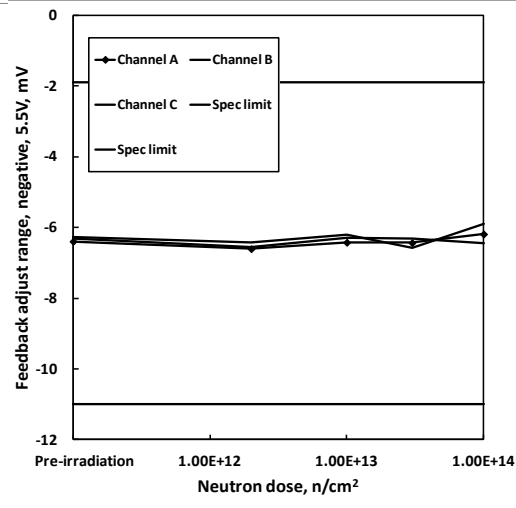

Fig. 41: ISL70001SRH negative feedback adjust range, all three channels, 5.5V in, as a function of neutron irradiation. Sample size was 5 for each cell (2×10^{12} n/cm², 1×10^{13} n/cm², 3×10^{13} n/cm² and 1×10^{14} n/cm²). The data sheet limits are -11.0mV to -1.9mV.

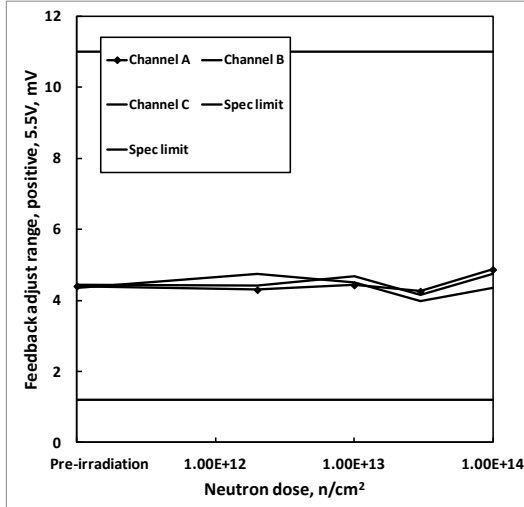

Fig. 42: ISL70001SRH positive feedback adjust range, all three channels, 5.5V in, as a function of neutron irradiation. Sample size was 5 for each cell (2×10^{12} n/cm², 1×10^{13} n/cm², 3×10^{13} n/cm² and 1×10^{14} n/cm²). The data sheet limits are +1.5mV to +11.0mV.

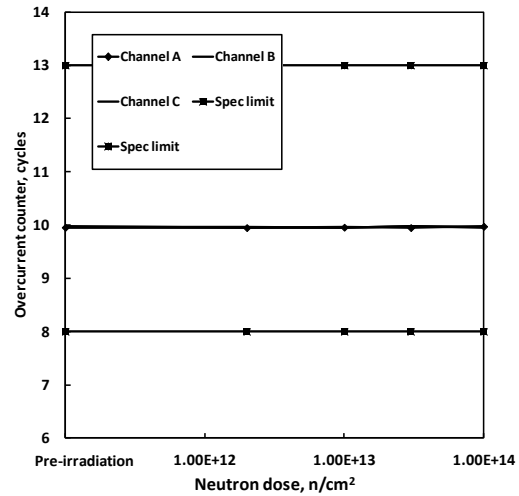

Fig. 44: ISL70001SRH overcurrent counter delay as a function of neutron irradiation. Sample size was 5 for each cell (2×10^{12} n/cm², 1×10^{13} n/cm², 3×10^{13} n/cm² and 1×10^{14} n/cm²). The data sheet limits are 8 to 13 cycles.

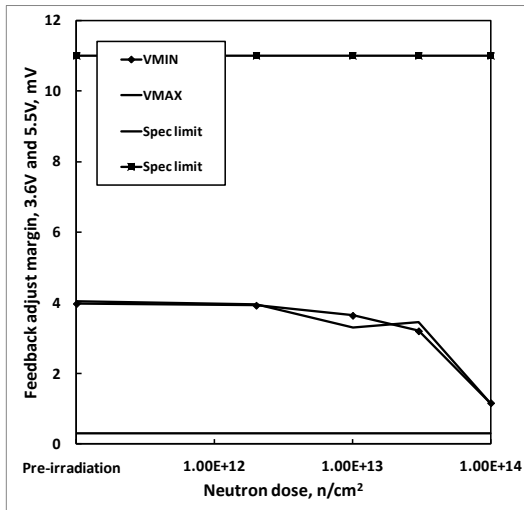

Fig. 43: ISL70001SRH feedback adjust margin, 3.6V and 5.5V input, as a function of neutron irradiation. Sample size was 5 for each cell (2×10^{12} n/cm², 1×10^{13} n/cm², 3×10^{13} n/cm² and 1×10^{14} n/cm²). The data sheet limit is 11.0mV maximum.

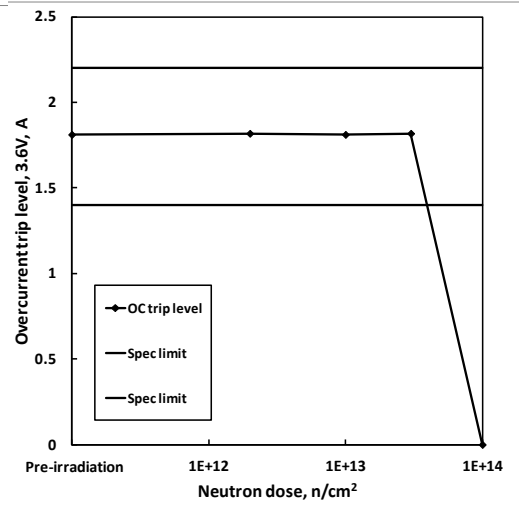

Fig. 45: ISL70001SRH overcurrent trip level, 3.6V input, as a function of neutron irradiation. Sample size was 5 for each cell (2×10^{12} n/cm², 1×10^{13} n/cm², 3×10^{13} n/cm² and 1×10^{14} n/cm²). The data sheet limits are 1.4A to 2.2A.

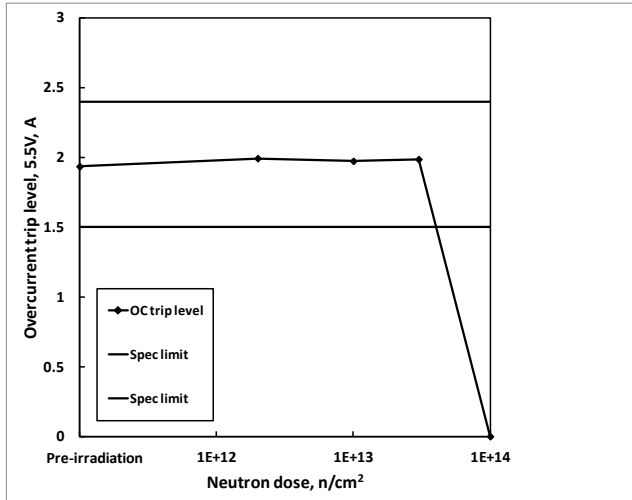

Fig. 46: ISL70001SRH overcurrent trip level, 5.5V input, as a function of neutron irradiation. Sample size was 5 for each cell (2×10^{12} n/cm², 1×10^{13} n/cm², 3×10^{13} n/cm² and 1×10^{14} n/cm²). The data sheet limits are 1.5A to 2.4A.

5: Discussion and conclusion

This document reports the results of neutron testing of the ISL70001SRH point of load converter. Parts were irradiated to levels of 2×10^{12} n/cm², 1×10^{13} n/cm², 3×10^{13} n/cm² and 1×10^{14} n/cm². ATE characterization testing was performed before and after the irradiations, and three control units were used to insure repeatable data. Variables data for selected parameters is presented in Figs. 2 through 46. We will discuss the results on a parameter by parameter basis. It should be realized when reviewing the data that each neutron irradiation was made on a different 5-unit sample; this is not total dose testing, where the damage is cumulative. The 2×10^{12} n/cm² level is of some interest in the context of recent developments in the JEDEC community, where the discrete component vendors have signed up for characterization testing (but not for acceptance testing) at this level. This industry trend led to the present work, which determines the response of the part to several neutron levels.

The ISL70001SRH is not formally designed for neutron hardness. The part is built in a BiCMOS process, and the CMOS elements may be expected to perform well in this environment. The bipolar transistors are minority carrier devices, however, and were expected to be sensitive at the higher levels. This expectation turned out to be correct. We will discuss the results on a parameter by parameter basis and then draw some conclusions.

The enable LOW and HIGH input currents (Figs. 2 and 3) and the master/slave control pin LOW and HIGH input currents (Figs. 5 and 4) were stable, and within the specification limits after 1×10^{14} n/cm². The power on reset (POR) threshold select LOW and HIGH input currents (Figs. 6 and 7) were stable, and within the specification limits after 1×10^{14} n/cm². The sync input pin HIGH input current (Fig. 8) remained stable and was within the specification limits after 1×10^{14} n/cm², but the equivalent LOW current (Fig. 9) was out of specification after 1×10^{14} n/cm² and marginally out of specification at 1×10^{13} n/cm².

The feedback input bias current (Fig. 10) remained within specification after 1×10^{14} n/cm².

The LX LOW and LX HIGH leakage current (Figs. 11 and 12) remained very stable to 1×10^{14} n/cm², reflecting good performance by these large integrated MOSFET devices.

The trimmed reference voltage and reference output voltage (Figs. 13, 15 and 16) increased marginally beyond the +1% mark at 3×10^{13} n/cm², passing an increased limit of +1.5%, but were well out of specification after 1×10^{14} n/cm². The trimmed bandgap voltage (Fig. 14) remained within specification after 1×10^{14} n/cm². The post trim reference current (Fig. 18) showed a minor increase but was still within specifications after 1×10^{14} n/cm².



The shutdown supply current (Figs. 17 and 18) at both 3.6V and 5.5V remained very stable through 1×10^{14} n/cm². The supply current at both 3.6V in and 5.5V (Figs. 24 and 25) in remained flat to 3×10^{13} n/cm² and was just out of specification after 1×10^{14} n/cm².

The oscillator frequency and the input voltage rejection of this parameter (Figs. 20 and 21) remained within specification at 3×10^{13} n/cm² but were out of specification after 1×10^{14} n/cm². The minimum ON time and minimum OFF time (Figs. 22 and 23) were stable through 3×10^{13} n/cm² and were still within specifications after 1×10^{14} n/cm².

A functional test at 3.6V (Fig. 26) input remained flat to 3×10^{13} n/cm² and was nonfunctional after 1×10^{14} n/cm². The equivalent test at 5.5V (Fig. 27) in remained functional through 1×10^{14} n/cm².

The lower and upper FET ON resistance and ON resistance match remained very stable (Figs. 28 through 31) through 1×10^{14} n/cm², also reflecting good performance by these large integrated MOSFET devices.

The SYNC pin VOL and VOH for both the 3.6V and 5.5V in cases, the ENABLE threshold at 3.6V and 5.5V in and the POR Rising and falling threshold at 3.6V and 5.5V remained flat (Figs. 32 through 35) to 3×10^{13} n/cm² and were nonfunctional after 1×10^{14} n/cm².

The undervoltage trip threshold (Fig. 36) remained within specifications after 1×10^{14} n/cm².

The error amplifier input offset voltage (Fig. 37) for the 3.6V in case (all three channels) remained within specifications at 2×10^{12} n/cm², met a 5mV spec at 1×10^{13} n/cm² and exceeded 10mV after 3×10^{13} and 1×10^{14} n/cm². At 5.5V in (Fig. 40), this parameter remained within specifications after 2×10^{12} n/cm², met a 5mV spec at 1×10^{13} n/cm² and exceeded 15mV after 3×10^{13} and 1×10^{14} n/cm². The error amplifier Vmin and Vmax values (not shown) became increasingly positive with increased exposure. The negative and positive feedback adjust range for 3.6V in and 5.5V (Figs. 38, 39, 41 and 42) also increased, tracking the error amplifier shifts and resulting in the adjust margin being stable through 3×10^{13} and remaining within specifications after 1×10^{14} n/cm².

The overcurrent counter delay (Fig. 44) was stable to 1×10^{14} n/cm². The overcurrent trip levels for both 3.6V input and 5.5V input (Figs. 45 and 46) remained flat to 3×10^{13} n/cm² and were nonfunctional after 1×10^{14} n/cm².

We conclude that the ISL70001SRH is capable of post 3×10^{13} n/cm² operation with selected parametric relaxations such as error amp and voltage reference parameters. The part is not capable of post 1×10^{14} n/cm² performance as many parameters changed drastically and several units did not pass gross function tests.

6: Appendices

6.1: Reported parameters.

Fig.	Parameter	Limit, low	Limit, high	Units	Notes
2	Enable LOW input current	-1.2	+0.1	μA	
3	Enable HIGH input current	-1.2	+0.1	μA	
4	Master/slave control pin HIGH input current	-0.25	+0.25	μA	
5	Master/slave control pin LOW input current	-0.25	+0.25	μA	
6	POR threshold select HIGH input current	-0.25	+0.25	μA	
7	POR threshold select LOW input current	-0.25	+0.25	μA	
8	SYNC input pin HIGH input current	-0.25	+0.25	μA	
9	SYNC input pin LOW input current	-0.25	+0.25	μA	
10	Feedback input bias current	-0.25	+0.25	μA	
11	LX LOW leakage current	-0.4	+0.4	μA	
12	LX HIGH leakage current	-0.4	+0.4	μA	
13	Trimmed reference voltage	0.594	0.606	V	
14	Trimmed bandgap voltage	1.175	1.225	V	
15	Reference output voltage	0.594	0.606	V	3.6V in
16	Reference output voltage	0.594	0.606	V	5.5V in
17	Shutdown supply current	1.0	5.0	mA	3.6V in
18	Shutdown supply current	3.0	9.5	mA	5.5V in
19	Post trim reference current	0.93	1.09	mA	
20	Oscillator frequency	875	1125	KHz	
21	Oscillator frequency vs. input voltage	875	1125	KHz	
22	Minimum ON time		175	ns	
23	Minimum OFF time		100	ns	
24	Supply current	7.0	45.0	mA	3.6V in
25	Supply current	7.0	65.0	mA	5.5V in
26	Functional test	0.7	0.9	V	3.6V in
27	Functional test	2.4	3.2	V	5.5V in
28	Lower FET ON resistance	130.0	182.0	mohm	
29	Lower FET ON resistance match	-11.0	+7.2	%	
30	Upper FET ON resistance	190.0	260.0	mohm	
31	Upper FET ON resistance match	-9.0	+10.0	%	
32	SYNC pin VOL and VOH	25.0	350.0	mV	3.6V and 5.5V
33	ENABLE threshold	0.56	0.64	V	3.6V and 5.5V
34	POR Rising threshold	107.0	115.0	%	3.6V and 5.5V
35	POR Falling threshold	85.0	93.0	%	3.6V and 5.5V
36	Undervoltage trip threshold	71.0	79.0	%	3.6V in
37	Error amplifier input offset voltage	-0.8	+0.8	mV	3.6V in
38	Negative feedback adjust range	-11.0	-1.5	mV	3.6V in
39	Positive feedback adjust range	+1.5	+11.0	mV	3.6V in
40	Error amplifier input offset voltage	-2.0	+2.0	mV	5.5V in
41	Negative feedback adjust range	-11.0	-1.9	mV	5.5V in



42	Positive feedback adjust range	+1.5	+11.0	mV	5.5V in
43	Feedback adjust margin		11.0	mV	3.6V and 5.5V
44	Overcurrent counter delay	8	13	cycles	
45	Overcurrent trip level	1.4	2.2	A	3.6V in
46	Overcurrent trip level	1.5	2.4	A	5.5V in

7: Document revision history

Revision	Date	Pages	Comments
0	June 2012	All	Original issue