ISL70005SEH, ISL73005SEH

Total Dose Test Results of the ISL70005SEH and ISL730005SEH RadHard Dual Output Point-of-Load Regulators

Introduction

This report provides interim results of a Low Dose Rate (LDR) and High Dose Rate (HDR) Total Ionizing Dose (TID) test of the [ISL70005SEH](#) and [ISL73005SEH](#) dual output point-of-load converters, which combine a synchronous buck regulator and a low dropout voltage linear regulator. The two parts have identical electrical performance and differ only in their total dose specifications, and the ISL70005SEH results reported in this document apply equally to the ISL73005SEH. The test was conducted to determine the sensitivity of the parts to the total dose environment and to determine if the parts display dose rate or bias sensitivity. The test also included biased high temperature anneals after the completion of irradiation to evaluate time-dependent effects. The LDR used was 0.01rad(Si)/s and the HDR was 70rad(Si)/s.

HDR testing is complete through 150krad(Si) and subsequent high temperature biased anneal. LDR testing is complete through 100krad(Si) and subsequent high temperature biased anneal.

Product Description

The ISL70005SEH and ISL73005SEH are radiation hardened dual output Point-of-Load (POL) regulators combining the high efficiency of a synchronous buck regulator with the low noise of a Low Dropout (LDO) linear regulator. The parts are suited for 3.3V or 5V power buses and can support a continuous output load current of 3A for the buck regulator and ± 1 A for the LDO. [Figure 1](#) shows a block diagram.

The buck regulator uses voltage mode control architecture and switches at an adjustable frequency of 100kHz to 1MHz set by an external resistor. Externally adjustable loop compensation allows for an optimum balance between stability and output dynamic performance. The integrated synchronous power switches are optimized for high efficiency and excellent thermal performance.

The LDO is completely configurable independently of the switching regulator. It uses NMOS pass devices and the chip bias voltage (L_VCC) is used to drive the pass device gate. This enables the LDO to function with less than 1V on the L_VIN NMOS input. The LDO can sink and source up to 1A continuously making it a suitable choice for powering DDR memory.

The ISL70005SEH is radiation hardened to a TID rating of 100krad(Si) at HDR (50 - 300rad(Si)/s) and to 75krad(Si) at LDR (< 0.01 rad(Si)/s). The ISL73005SEH is radiation hardened to a TID rating of 75krad(Si) at LDR (< 0.01 rad(Si)/s). This document reports TID response data for 100krad(Si) at LDR and 150krad(Si) at HDR for the biased and unbiased cases. The ISL70005SEH is acceptance tested on a wafer-by-wafer basis to 75krad(Si) at LDR and to 100krad(Si) at HDR, while the ISL73005SEH variant is acceptance tested on a wafer-by-wafer basis to 75krad(Si) at LDR only. Both parts use the same die and the dataset reported in this document apply to both.

The ISL70005SEH and ISL73005SEH are also rated for Single-Event Effects (SEE). The parts are free of permanent damage up to a LET of 86MeV \cdot cm²/mg at a maximum supply voltage of 6.0V and a case temperature of +125°C \pm 10°C. Single-Event Transient (SET) performance is specified as a change in an output voltage of less than 3% at a LET of 86.4MeV \cdot cm²/mg. Single-Event Functional Interrupt (SEFI) free operation is specified up to a LET of 43MeV \cdot cm²/mg.

Both parts are implemented in a submicron BiCMOS process optimized for power management applications. The process is in volume production under MIL-PRF-38535 certification and is used for a wide range of commercial and radiation-hardened power management devices. The parts are available in a 28 Ld ceramic flatpack or die form and are specified across the military temperature range of -55°C to +125°C.

Related Literature

For a full list of related documents, visit our website:

- [ISL70005SEH, ISL73005SEH](#) device pages
- MIL-STD-883 test method 1019

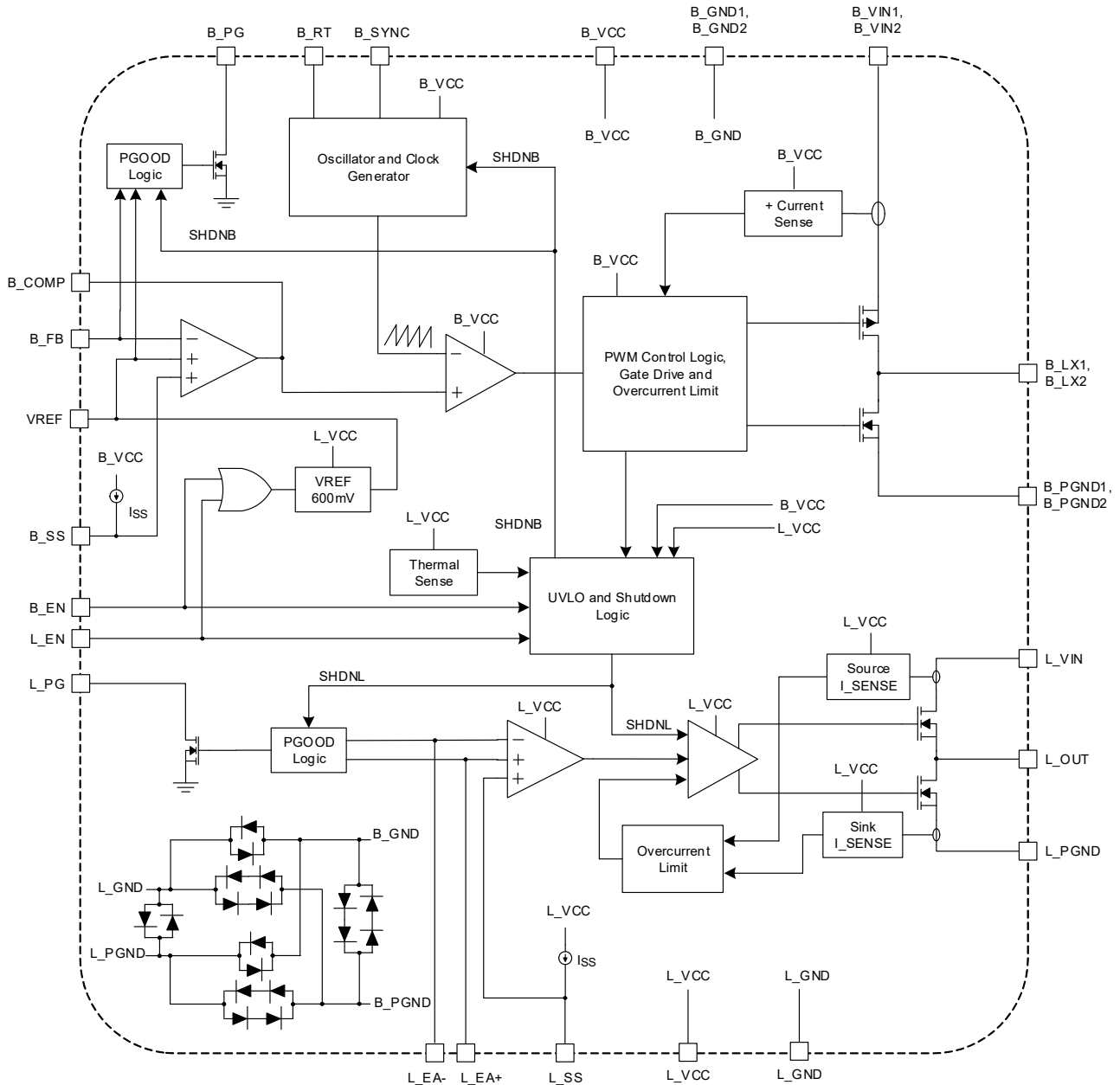

Figure 1. ISL70005SEH Block Diagram

1. Test Description

1.1 Irradiation Facilities

HDR testing was performed using a Gammacell 220 gamma-ray irradiator located in the Renesas Palm Bay, Florida facility. LDR testing used a Hopewell Designs (Alpharetta, GA) N40 vault-type LDR irradiator located in the same facility. The HDR irradiations were performed at 70rad(Si)/s and the LDR work was performed at 0.010rad(Si)/s, both per MIL-STD-883 Method 1019. The post-irradiation biased anneals used the same bias configuration (Figure 2) as the biased irradiation and were performed at 100°C using a small temperature chamber.

1.2 Test Fixturing

Figure 2 shows the configuration used for biased LDR and HDR irradiation and anneal.

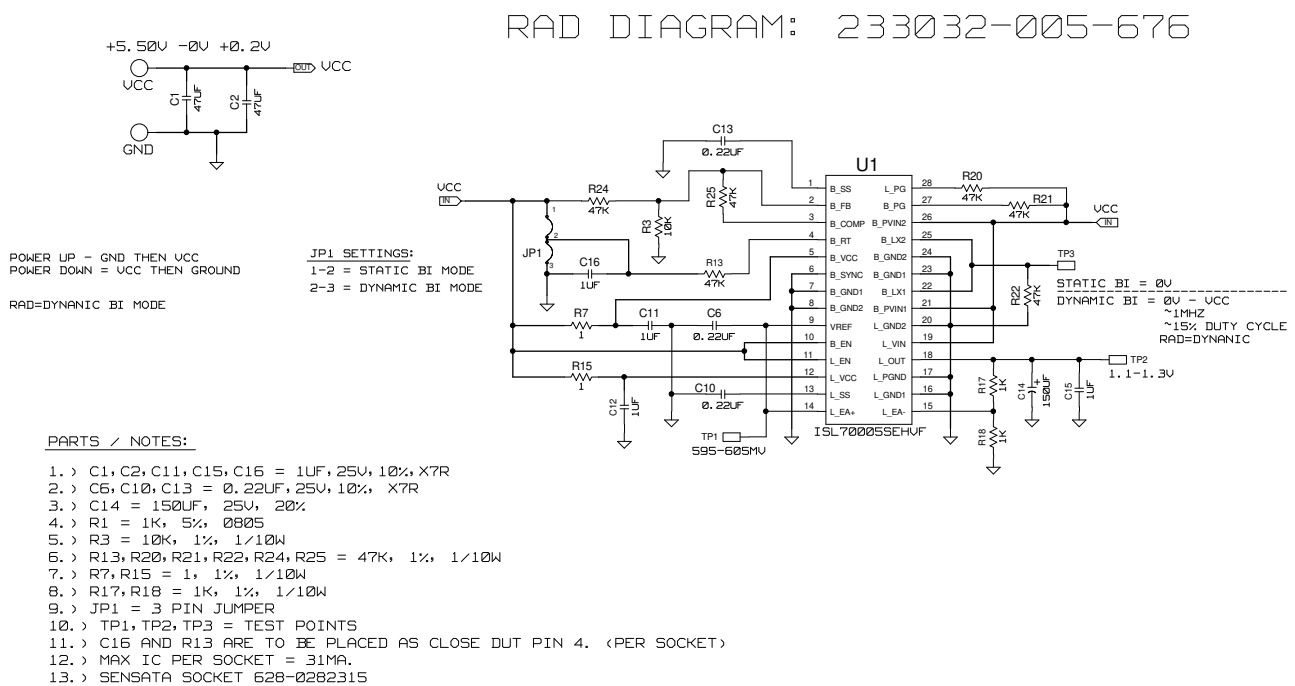

Figure 2. Irradiation and Anneal Bias Configuration

1.3 Characterization Equipment and Procedures

All electrical testing was performed outside the irradiator using the production Automated Test Equipment (ATE) with data logging at each down point. Down point electrical testing was performed at room temperature. Three control units were used to ensure repeatable data.

1.4 Experimental Matrix

Testing proceeded in accordance with the LDR sensitivity diagnostic protocol outlined in MIL-STD-883 Test Method 1019. The experimental matrix consisted of 12 samples irradiated at HDR with all pins grounded, 12 samples irradiated at HDR under bias, 21 samples irradiated at LDR with all pins grounded and 21 samples irradiated at LDR under bias. A biased anneal at 100°C for 168 hours was performed on the HDR samples following the final irradiation to evaluate the Time-Dependent Effect (TDE) characteristics of the part.

Samples of the ISL70005SEH were drawn from lot 1KJWB00000, wafer A3IBVUW and were packaged in production package code KDA 28 Ld ceramic flatpacks. Samples were processed through the standard QML-V

burn-in screens of 180 hours dynamic burn-in and 72 hours static burn-in before irradiation, as required by MIL-STD-883, and were screened to the SMD 5962-19209 limits at room, low, and high temperature before the start of total dose testing.

1.5 Down Points

The HDR down points were 0, 10, 30, 50, 100, and 150krad(Si) and the LDR down points to date were 0, 10, 30, 50, 75, 100krad(Si). The biased anneals were performed at 100°C for 168 hours.

2. Results

Total dose testing of the ISL70005SEH showed no reject devices at any down point after biased or grounded irradiation at either dose rate or after the subsequent anneals. All samples were classified as Bin 1 at all down points including annealing, indicating full compliance with datasheet and SMD limits. It should be noted that all SMD pre-irradiation and post-irradiation limits are identical for this part.

2.1 Attributes Data

Table 1. Attributes Data

Part	Dose Rate (rad(Si)/s)	Bias	Sample Size	Down Point	Pass ^[1]	Fail
ISL70005SEH	70	Biased	12	Pre-irradiation	12	0
				10krad(Si)	12	0
				30krad(Si)	12	0
				50krad(Si)	12	0
				100krad(Si)	12	0
				150krad(Si)	12	0
				Anneal, 100C under bias	12	0
ISL70005SEH	70	Grounded	12	Pre-irradiation	12	0
				10krad(Si)	12	0
				30krad(Si)	12	0
				50krad(Si)	12	0
				100krad(Si)	12	0
				150krad(Si)	12	0
				Anneal, 100C under bias	12	0
ISL70005SEH	0.010	Biased	21	Pre-irradiation	21	0
				10krad(Si)	21	0
				30krad(Si)	21	0
				50krad(Si)	21	0
				75krad(Si)	21	0
				100krad(Si)	21	
				Anneal, 100C under bias	21	

Table 1. Attributes Data (Cont.)

Part	Dose Rate (rad(Si)/s)	Bias	Sample Size	Down Point	Pass ^[1]	Fail
ISL70005SEH	0.010	Grounded	21	Pre-irradiation	21	0
				10krad(Si)	21	0
				30krad(Si)	21	0
				50krad(Si)	21	0
				75krad(Si)	21	0
				100krad(Si)	21	
				Anneal, 100C under bias	21	

1. A pass indicates a sample that passes all SMD limits.

2.2 Variables Data

Figure 3 through Figure 21 show the total dose response of selected critical parameters at all down points to date. The plots show the average as a function of the total dose for each of the irradiation conditions. All parts showed good stability over irradiation and anneal, with no observed dose rate or bias sensitivity.

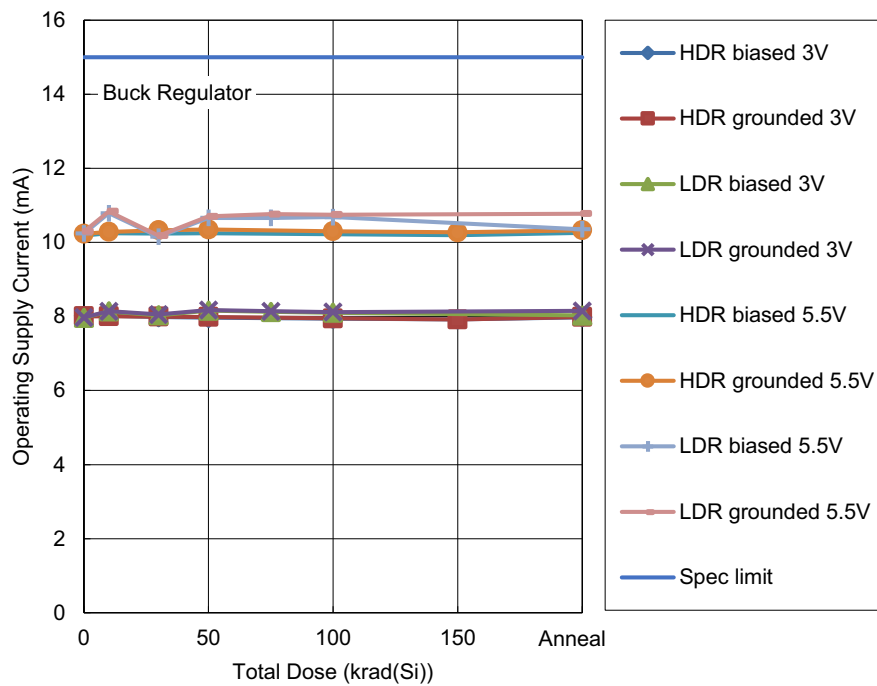

Figure 3. ISL70005SEH buck regulator operating power supply current at 100kHz, 3.0V and 5.5V supply cases, as a function of total dose irradiation at LDR and HDR for the unbiased and biased cases. All irradiations were followed by a high temperature biased anneal at 100°C for 168 hours. The LDR was 0.01rad(Si)/s and the HDR was 70rad(Si)/s. Sample sizes are given in Table 1. The SMD limit is 15mA maximum for both supply voltage cases.

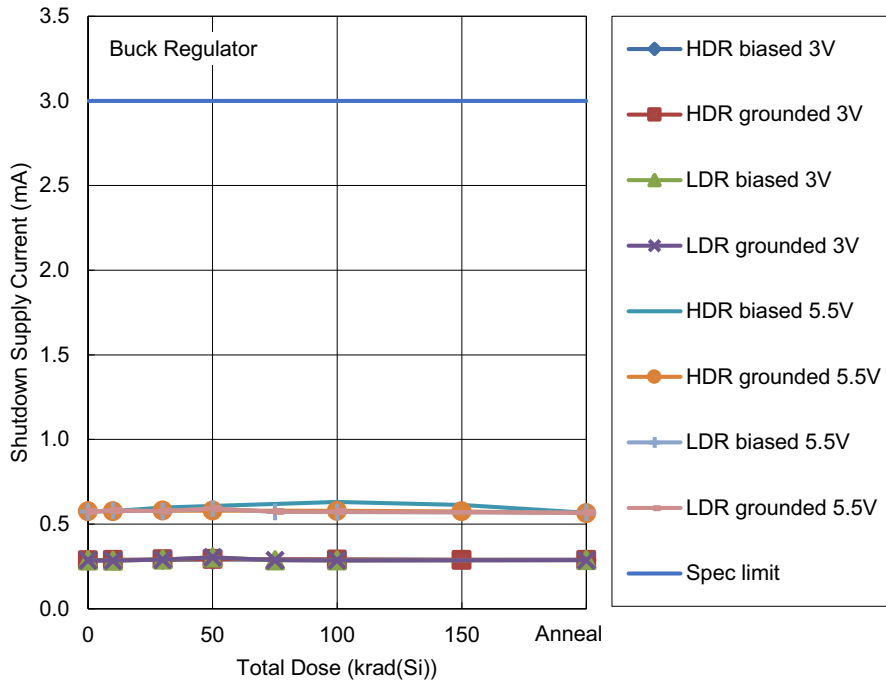

Figure 4. ISL70005SEH buck regulator shutdown power supply current, 3.0V and 5.5V supply cases, as a function of total dose irradiation at LDR and HDR for the unbiased and biased cases. All irradiations were followed by a high temperature biased anneal at 100°C for 168 hours. The LDR was 0.01rad(Si)/s and the HDR was 70rad(Si)/s. Sample sizes are given in Table 1. The SMD limit is 3.0mA maximum for both supply voltage cases..

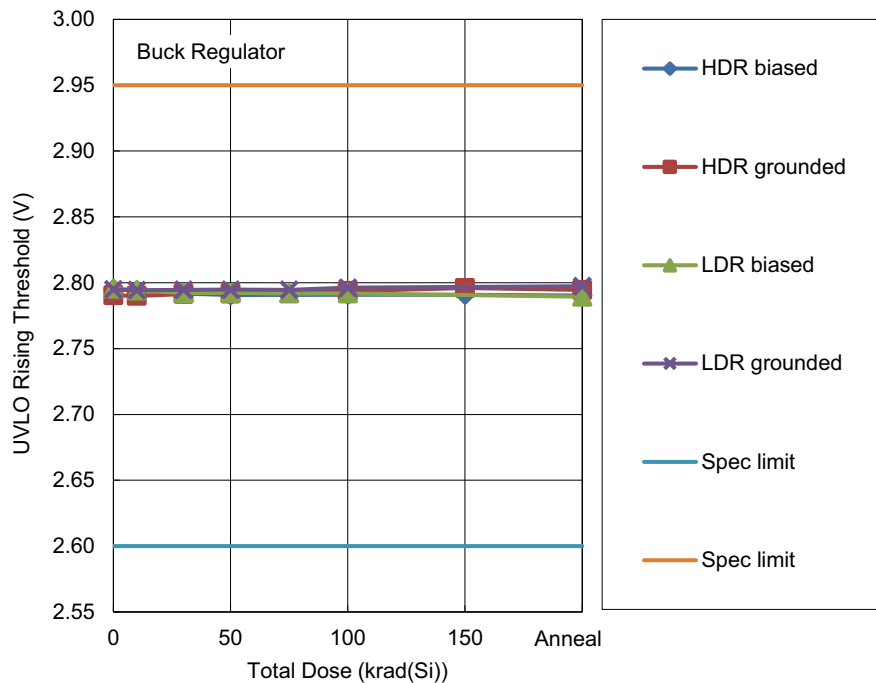

Figure 5. ISL70005SEH buck regulator undervoltage lockout (UVLO) rising threshold as a function of total dose irradiation at LDR and HDR for the unbiased and biased cases. All irradiations were followed by a high temperature biased anneal at 100°C for 168 hours. The LDR was 0.01rad(Si)/s and the HDR was 70rad(Si)/s. Sample sizes are given in Table 1. The SMD limits are 2.60V to 2.95V.

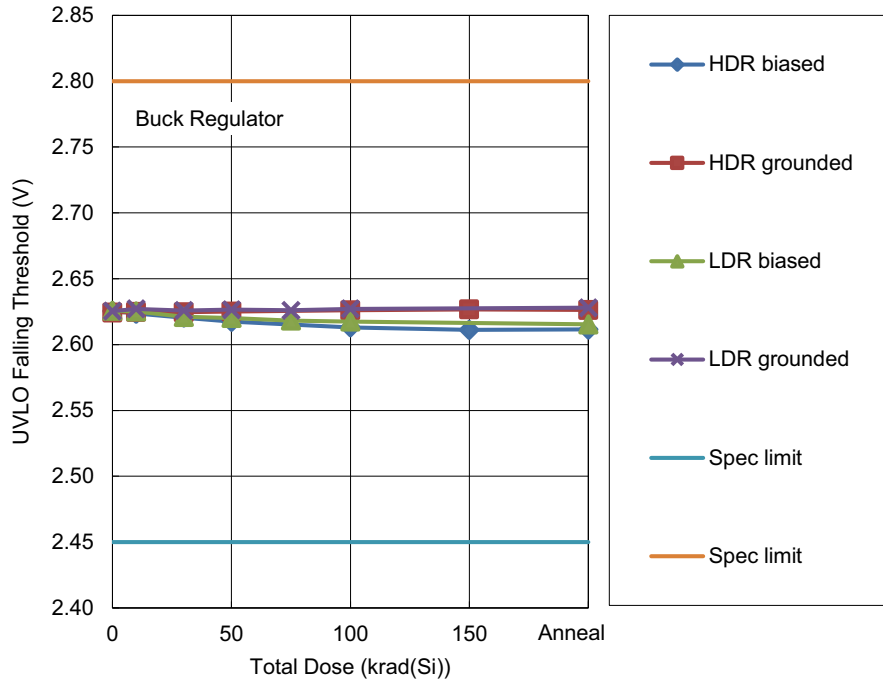

Figure 6. ISL70005SEH buck regulator undervoltage lockout (UVLO) falling threshold as a function of total dose irradiation at LDR and HDR for the unbiased and biased cases. All irradiations were followed by a high temperature biased anneal at 100°C for 168 hours. The LDR was 0.01rad(Si)/s and the HDR was 70rad(Si)/s. Sample sizes are given in Table 1. The SMD limits are 2.45V to 2.80V.

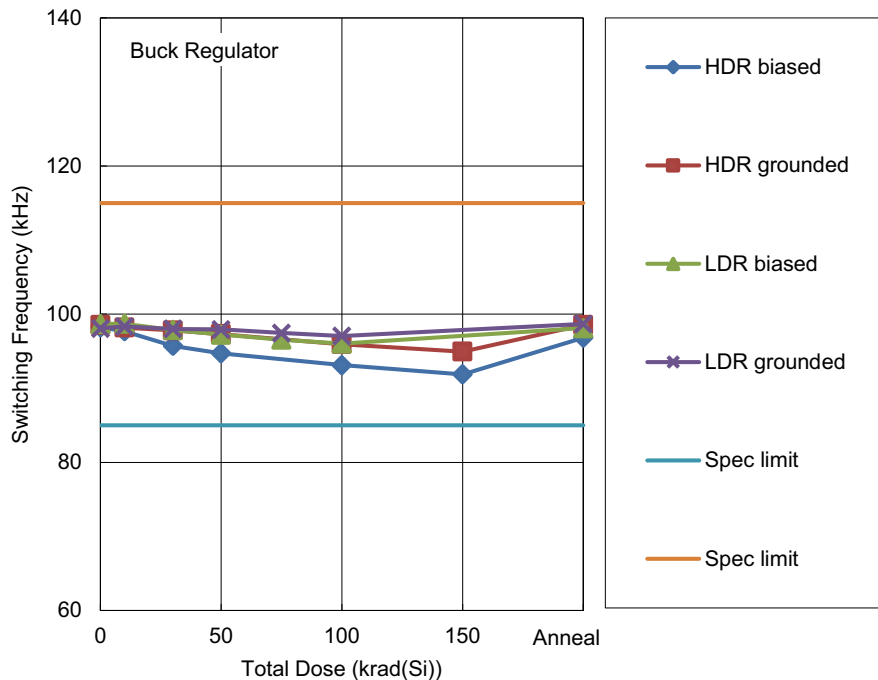

Figure 7. ISL70005SEH buck regulator switching frequency as a function of total dose irradiation at LDR and HDR for the unbiased and biased cases. All irradiations were followed by a high temperature biased anneal at 100°C for 168 hours. The LDR was 0.01rad(Si)/s and the HDR was 70rad(Si)/s. Sample sizes are given in Table 1. The SMD limits are 85kHz to 115kHz.

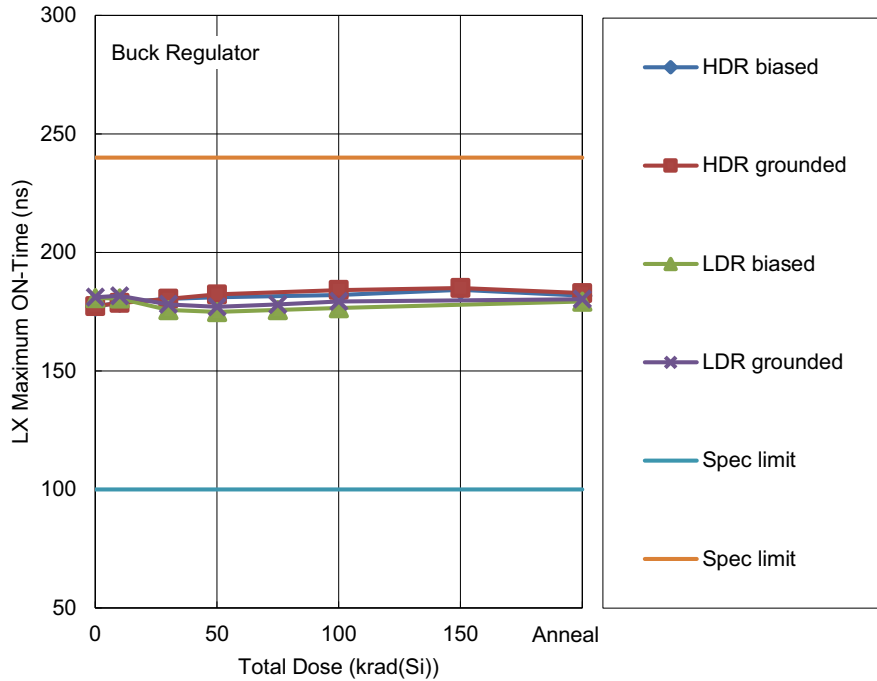

Figure 8. ISL70005SEH buck regulator LX output maximum ON time, 5.5V supply, as a function of total dose irradiation at LDR and HDR for the unbiased and biased cases. All irradiations were followed by a high temperature biased anneal at 100°C for 168 hours. The LDR was 0.01rad(Si)/s and the HDR was 70rad(Si)/s. Sample sizes are given in Table 1. The SMD limits are 100ns to 240ns.

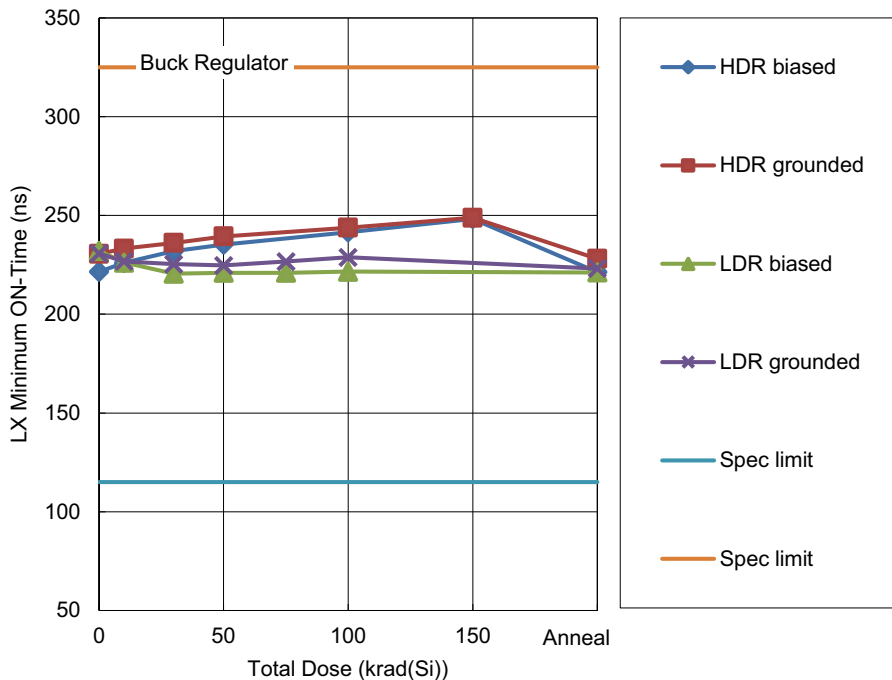

Figure 9. ISL70005SEH buck regulator LX minimum ON time, 3.0V supply, as a function of total dose irradiation at LDR and HDR for the unbiased and biased cases. All irradiations were followed by a high temperature biased anneal at 100°C for 168 hours. The LDR was 0.01rad(Si)/s and the HDR was 70rad(Si)/s. Sample sizes are given in Table 1. The SMD limits are 115ns to 325ns.

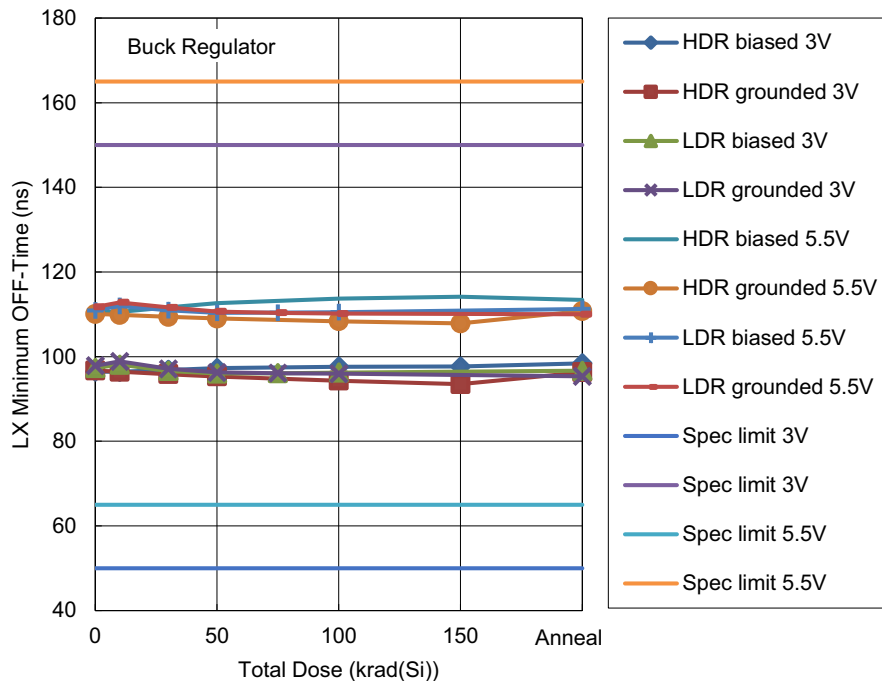

Figure 10. ISL70005SEH buck regulator LX minimum OFF time, 3.0V and 5.5V supply, as a function of total dose irradiation at LDR and HDR for the unbiased and biased cases. All irradiations were followed by a high temperature biased anneal at 100°C for 168 hours. The LDR was 0.01rad(Si)/s and the HDR was 70rad(Si)/s. Sample sizes are given in Table 1. The SMD limits are 50ns to 150ns (3.0V) and 65ns to 165ns (5.5V).

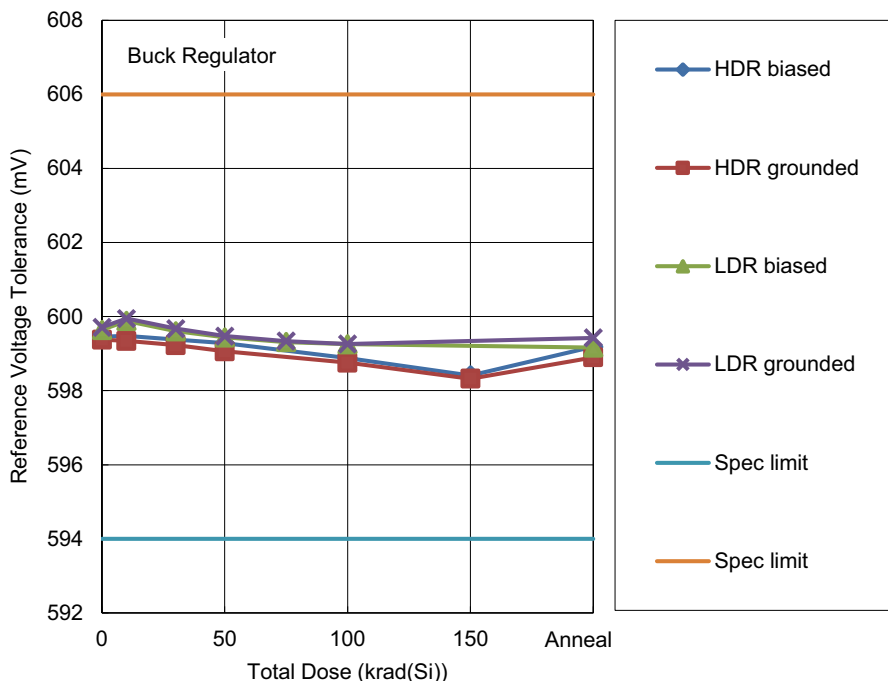

Figure 11. ISL70005SEH buck regulator reference voltage tolerance (defined as the sum of VREF and error amplifier VIO) as a function of total dose irradiation at LDR and HDR for the unbiased and biased cases. All irradiations were followed by a high temperature biased anneal at 100°C for 168 hours. The LDR was 0.01rad(Si)/s and the HDR was 70rad(Si)/s. Sample sizes are given in Table 1. The SMD limits are 594mV to 606mV.

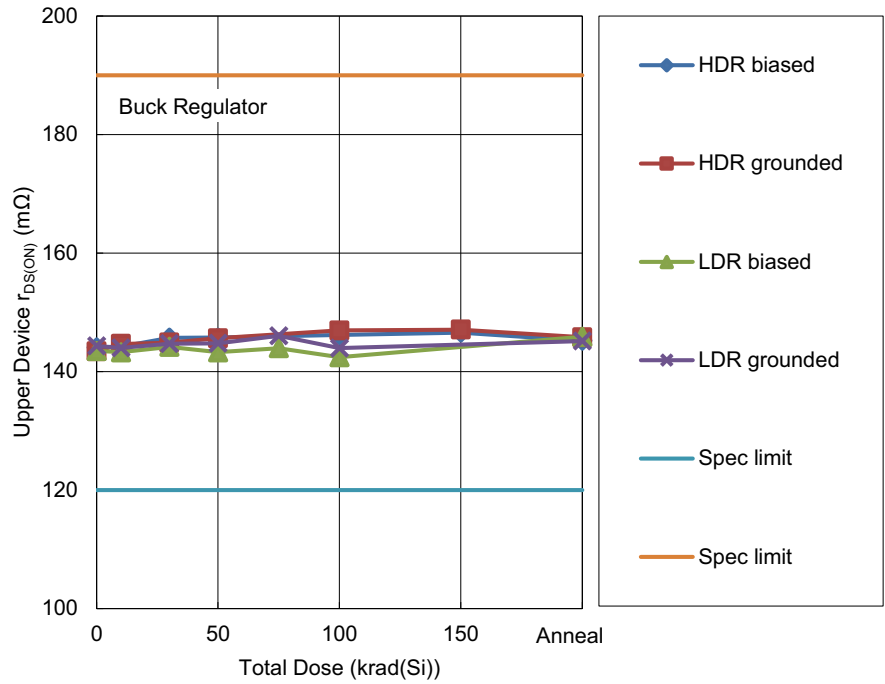

Figure 12. ISL70005SEH buck regulator upper device ON-resistance, 3.0V supply, as a function of total dose irradiation at LDR and HDR for the unbiased and biased cases. All irradiations were followed by a high temperature biased anneal at 100°C for 168 hours. The LDR was 0.01rad(Si)/s and the HDR was 70rad(Si)/s. Sample sizes are given in Table 1. The SMD limits are 120mΩ to 190mΩ.

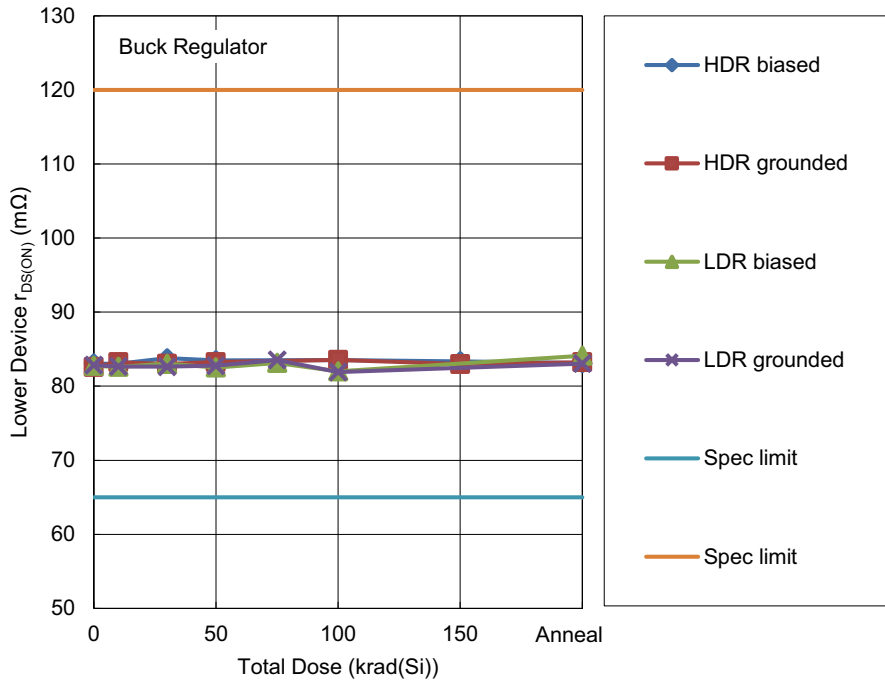

Figure 13. ISL70005SEH buck regulator lower device ON-resistance, 3.0V supply, as a function of total dose irradiation at LDR and HDR for the unbiased and biased cases. All irradiations were followed by a high temperature biased anneal at 100°C for 168 hours. The LDR was 0.01rad(Si)/s and the HDR was 70rad(Si)/s. Sample sizes are given in Table 1. The SMD limits are 65mΩ to 120mΩ.

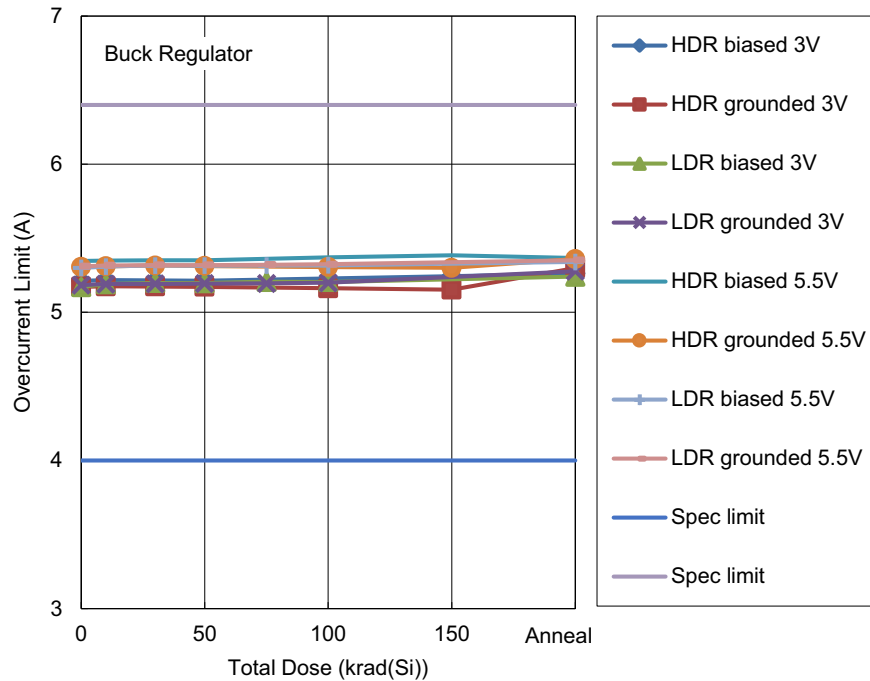

Figure 14. ISL70005SEH buck regulator overcurrent limit, 3.0V and 5.5V supply cases, as a function of total dose irradiation at LDR and HDR for the unbiased and biased cases. All irradiations were followed by a high temperature biased anneal at 100°C for 168 hours. The LDR was 0.01rad(Si)/s and the HDR was 70rad(Si)/s. Sample sizes are given in Table 1. The SMD limits are 4.0 A to 6.4 A for both cases.

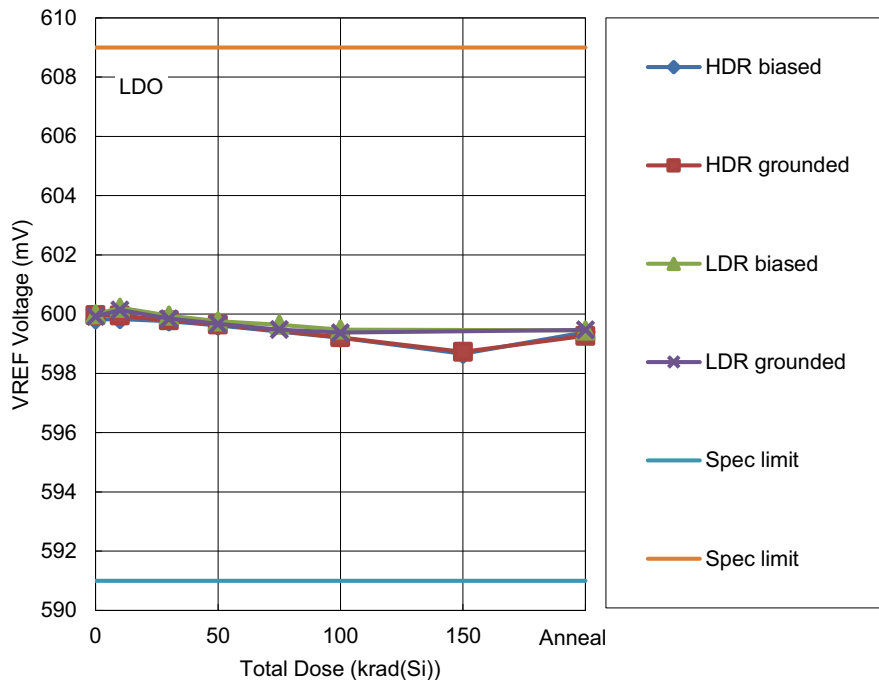

Figure 15. ISL70005SEH LDO reference voltage as a function of total dose irradiation at LDR and HDR for the unbiased and biased cases. All irradiations were followed by a high temperature biased anneal at 100°C for 168 hours. The LDR was 0.01rad(Si)/s and the HDR was 70rad(Si)/s. Sample sizes are given in Table 1. The SMD limits are 591mV to 609mV.

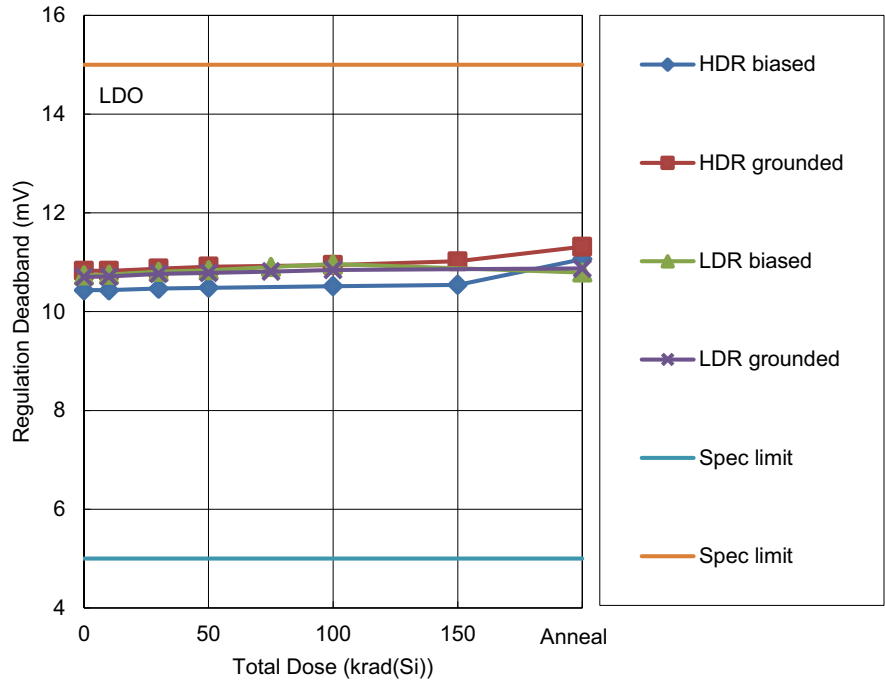

Figure 16. ISL70005SEH LDO regulation deadband, 5.5V supply, as a function of total dose irradiation at LDR and HDR for the unbiased and biased cases. All irradiations were followed by a high temperature biased anneal at 100°C for 168 hours. The LDR was 0.01rad(Si)/s and the HDR was 70rad(Si)/s. Sample sizes are given in Table 1. The SMD limits are 5mV to 15mV.

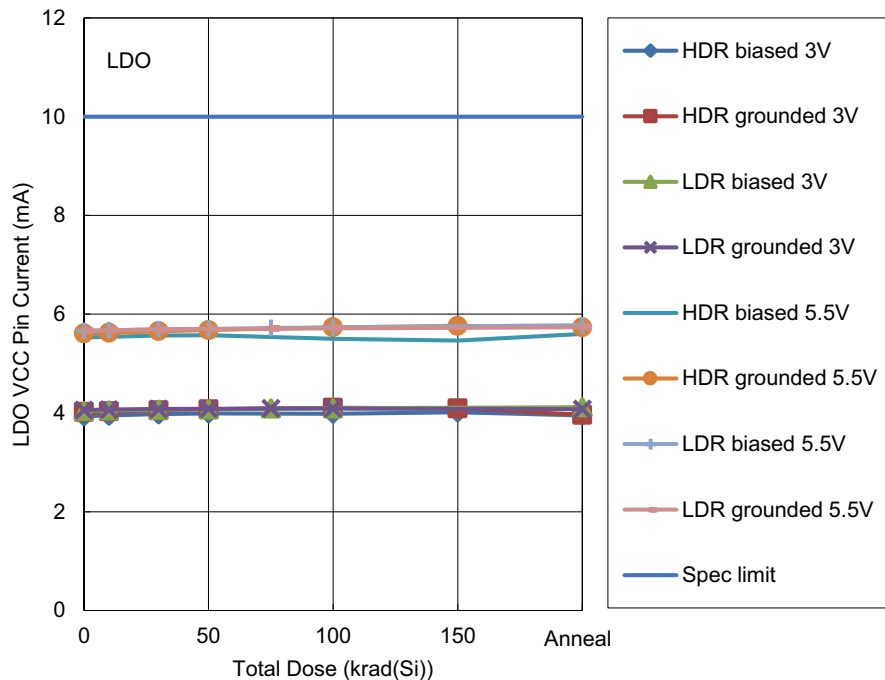

Figure 17. ISL70005SEH LDO VCC pin current, 3V and 5.5V supply, as a function of total dose irradiation at LDR and HDR for the unbiased and biased cases. All irradiations were followed by a high temperature biased anneal at 100°C for 168 hours. The LDR was 0.01rad(Si)/s and the HDR was 70rad(Si)/s. Sample sizes are given in Table 1. The SMD limit is 10mA maximum for both cases.

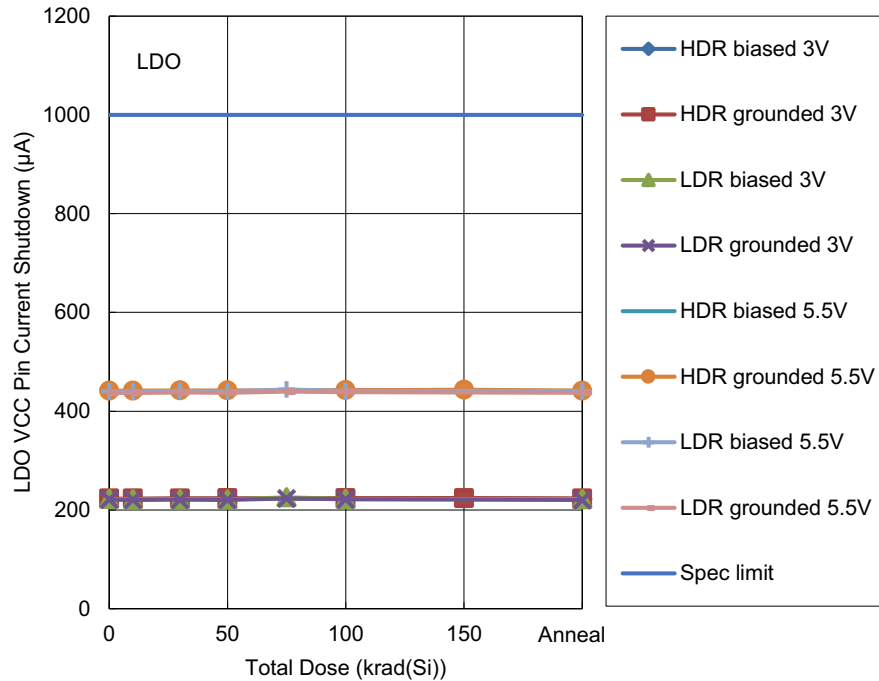

Figure 18. ISL70005SEH LDO VCC pin current in shutdown mode, 3V and 5.5V supply, as a function of total dose irradiation at LDR and HDR for the unbiased and biased cases. All irradiations were followed by a high temperature biased anneal at 100°C for 168 hours. The LDR was 0.01rad(Si)/s and the HDR was 70rad(Si)/s. Sample sizes are given in Table 1. The SMD limit is 1000µA maximum for both cases.

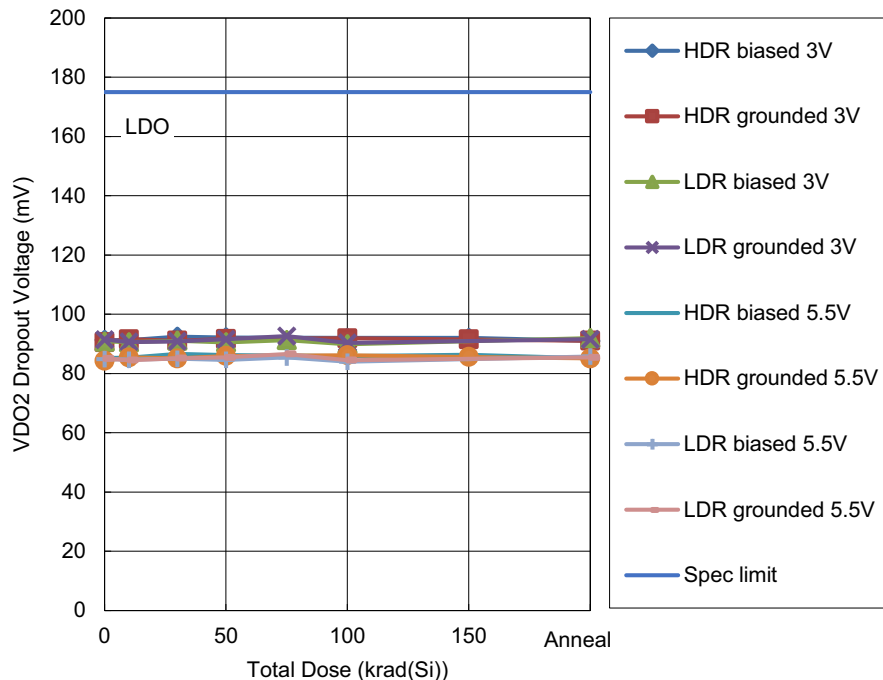

Figure 19. ISL70005SEH LDO VDO2 dropout voltage, 3V and 5.5V supply, as a function of total dose irradiation at LDR and HDR for the unbiased and biased cases. All irradiations were followed by a high temperature biased anneal at 100°C for 168 hours. The LDR was 0.01rad(Si)/s and the HDR was 70rad(Si)/s. Sample sizes are given in Table 1. The SMD limit is 175mV maximum for both cases.

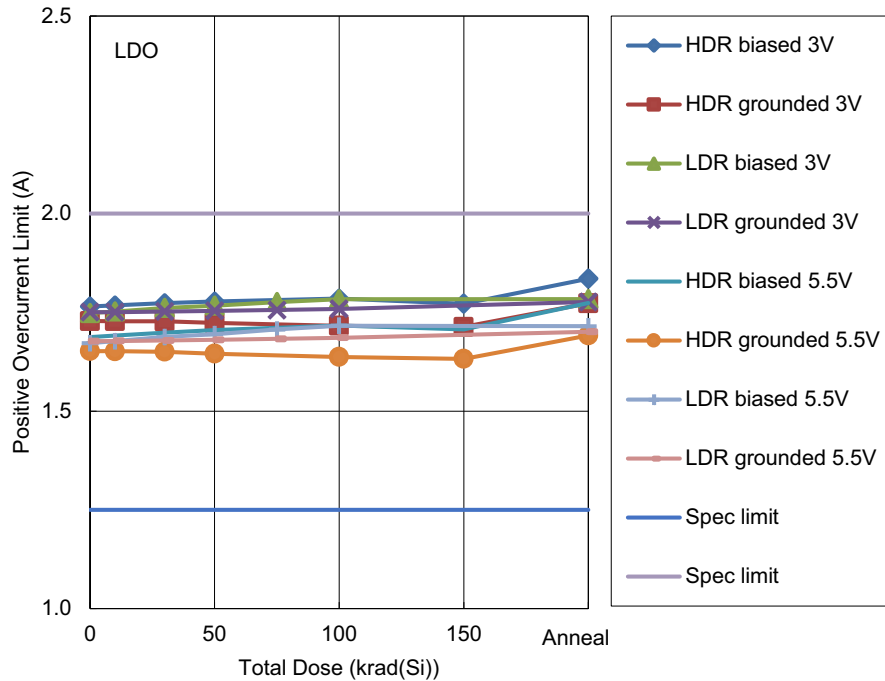

Figure 20. ISL70005SEH LDO positive overcurrent limit, 3V and 5.5V supply, as a function of total dose irradiation at LDR and HDR for the unbiased and biased cases. All irradiations were followed by a high temperature biased anneal at 100°C for 168 hours. The LDR was 0.01rad(Si)/s and the HDR was 70rad(Si)/s. Sample sizes are given in Table 1. The SMD limits are 1.25A to 2.0A for both cases.

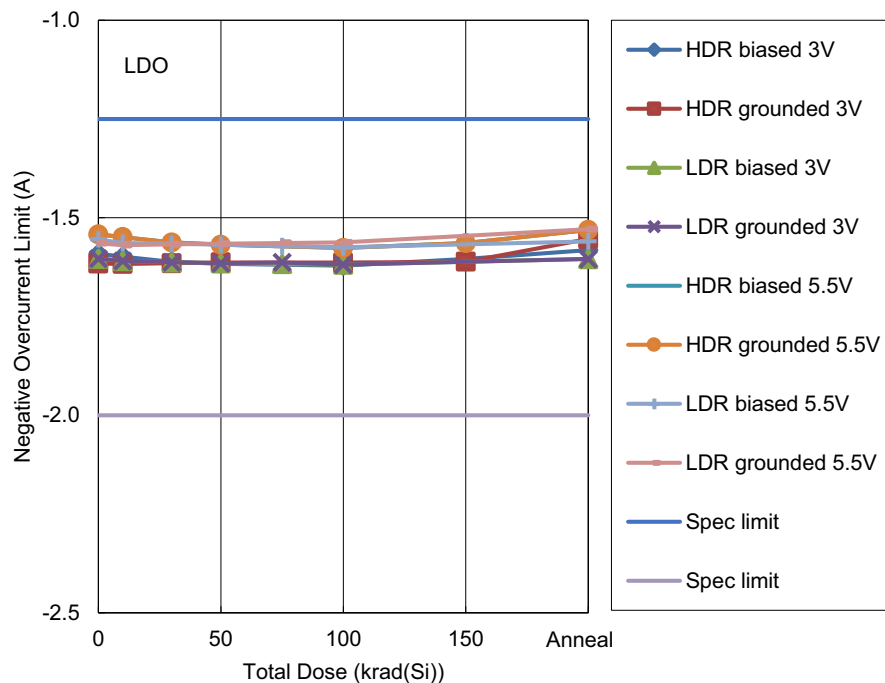

Figure 21. ISL70005SEH LDO negative overcurrent limit, 3V and 5.5V supply, as a function of total dose irradiation at LDR and HDR for the unbiased and biased cases. All irradiations were followed by a high temperature biased anneal at 100°C for 168 hours. The LDR was 0.01rad(Si)/s and the HDR was 70rad(Si)/s. Sample sizes are given in Table 1. The SMD limits are -2.0A to -1.25A for both cases.

3. Discussion and Conclusion

This document reports the results to date of TID testing of the ISL70005SEH radiation hardened dual point-of-load regulator, with data applying directly to the ISL73005SEH variant. Parts were tested at LDR and HDR under biased and unbiased conditions, as outlined in MIL-STD-883 TM1019. HDR and LDR testing is complete through 150krad(Si) and 100krad(Si), respectively, and through the subsequent high temperature biased anneals. All samples showed excellent stability over irradiation and anneal, with no observed LDR sensitivity (or HDR sensitivity, for that matter). It should be noted that the SMD pre-irradiation and post-irradiation limits are identical for this part. No differences between biased and unbiased irradiation were noted, and the part is not considered bias sensitive or dose rate sensitive. A detailed discussion of the response of the critical parameters is omitted as a look at the figures shows that there was very little change.

4. Appendix

Table 2. Reported Parameters and Figures

Figure	Parameter	SMD Symbol	Low Limit	High Limit	Units
Buck Regulator Section					
3	Operating Supply Current	IOP	-	15	mA
4	Shutdown Supply Current	ISDN	-	3	mA
5	B_VCC Internal UVLO Rising Threshold	PORRT	2.60	2.95	V
6	B_VCC Internal UVLO Falling Threshold	PORFT	2.45	2.80	V
7	Switching Frequency	t_{SF}	85	115	kHz
8	B_LXx Minimum On-Time	t_{ON}	100	240	ns
9	B_LXx Minimum On-Time	t_{ON1}	115	325	ns
10	B_LXx Minimum Off-Time (3V)	t_{OFF}	50	150	ns
	B_LXx Minimum Off-Time (5V)		65	165	ns
11	Reference Voltage Tolerance	$V_{REF} + V_{IO}$	594	606	mV
12	Packaged Upper Device $r_{DS(ON)}$	PURON	80	245	m Ω
13	Packaged Lower Device $r_{DS(ON)}$	PLRON	40	160	m Ω
14	Overcurrent Limit	OCL	4.0	6.4	A
Low Dropout Regulator Section					
15	VREF Voltage	V_{REF}	591	609	mV
16	Regulation Deadband	RegDB	5	15	mV
17	L_VCC Pin Current	I_Q	-	10	mA
18	L_VCC Pin Current in Shutdown	I_{SHDN}	-	1000	μ A
19	Dropout Voltage, VDO	VDO2	-	145	mV
20	Positive Overcurrent Limit	LOCLP	1.25	2.0	A
21	Negative Overcurrent Limit	LOCLN	-2.0	-1.25	A

5. Revision History

Rev.	Date	Description
2.00	Nov 1, 2022	Updated title to include ISL73005SEH. Added 100Krad LDR data throughout. Updated Introduction section, Down Points section, Results section, Table 1, Figures 3 -21, including captions, and Discussion and Conclusion section.
1.00	Jan 15, 2020	Initial release

IMPORTANT NOTICE AND DISCLAIMER

RENESAS ELECTRONICS CORPORATION AND ITS SUBSIDIARIES (“RENESAS”) PROVIDES TECHNICAL SPECIFICATIONS AND RELIABILITY DATA (INCLUDING DATASHEETS), DESIGN RESOURCES (INCLUDING REFERENCE DESIGNS), APPLICATION OR OTHER DESIGN ADVICE, WEB TOOLS, SAFETY INFORMATION, AND OTHER RESOURCES “AS IS” AND WITH ALL FAULTS, AND DISCLAIMS ALL WARRANTIES, EXPRESS OR IMPLIED, INCLUDING, WITHOUT LIMITATION, ANY IMPLIED WARRANTIES OF MERCHANTABILITY, FITNESS FOR A PARTICULAR PURPOSE, OR NON-INFRINGEMENT OF THIRD PARTY INTELLECTUAL PROPERTY RIGHTS.

These resources are intended for developers skilled in the art designing with Renesas products. You are solely responsible for (1) selecting the appropriate products for your application, (2) designing, validating, and testing your application, and (3) ensuring your application meets applicable standards, and any other safety, security, or other requirements. These resources are subject to change without notice. Renesas grants you permission to use these resources only for development of an application that uses Renesas products. Other reproduction or use of these resources is strictly prohibited. No license is granted to any other Renesas intellectual property or to any third party intellectual property. Renesas disclaims responsibility for, and you will fully indemnify Renesas and its representatives against, any claims, damages, costs, losses, or liabilities arising out of your use of these resources. Renesas' products are provided only subject to Renesas' Terms and Conditions of Sale or other applicable terms agreed to in writing. No use of any Renesas resources expands or otherwise alters any applicable warranties or warranty disclaimers for these products.

(Rev.1.0 Mar 2020)

Corporate Headquarters

TOYOSU FORESIA, 3-2-24 Toyosu,
Koto-ku, Tokyo 135-0061, Japan
www.renesas.com

Contact Information

For further information on a product, technology, the most up-to-date version of a document, or your nearest sales office, please visit:
www.renesas.com/contact/

Trademarks

Renesas and the Renesas logo are trademarks of Renesas Electronics Corporation. All trademarks and registered trademarks are the property of their respective owners.