

ISL70517SEH, ISL70617SEH

Single Event Effects (SEE) Testing

TR019

Rev 1.00

November 24, 2015

Introduction

The intense proton and heavy ion environment encountered in space applications can cause a variety of Single Event Effects (SEE) in electronic circuitry, including Single Event Upset (SEU), Single Event Transient (SET), Single Event Functional Interrupt (SEFI), Single Event Gate Rupture (SEGR) and Single Event Burnout (SEB). SEE can lead to system-level performance issues including disruption, degradation and destruction. For predictable and reliable space system operation, individual electronic components should be characterized to determine their SEE response. This report discusses the results of SEE testing performed on the [ISL70617SEH](#) and [ISL70517SEH](#) instrumentation amplifiers.

Product Description

The ISL70617SEH is a differential output instrumentation amplifier. The ISL70517SEH is a single-ended output instrumentation amplifier based on the ISL70617SEH. The ISL70617SEH and ISL70517SEH parts are metal mask and bond options of the same silicon die. Further description and explanation of the differences between the parts can be found in the datasheets.

Product Documentation

[ISL70617SEH](#) datasheet

[ISL70517SEH](#) datasheet

Standard Microcircuit Drawing (SMD): [5962-15246](#)

SEE Test Objectives

The ISL70617SEH and ISL70517SEH were both tested to determine their susceptibility to destructive single event effects (referred to herein as SEB) and to characterize their Single Event Transient (SET) behavior over different operating conditions.

SEE Test Facility

Testing was performed at the Texas A&M University (TAMU) Radiation Effects Facility of the Cyclotron Institute heavy ion facility. This facility is coupled to a K500 super conducting cyclotron, which is capable of generating a wide range of particle beams with the various energy, flux, and fluence levels needed for advanced radiation testing. Further details on the test facility can be found at the website (<http://cyclotron.tamu.edu/>). The Devices Under Test (DUTs) were located in air at 30mm from the aramica window for the ion beam. Ion LET values are quoted at the DUT surface. Signals were communicated to and from the DUT test fixture through 20 foot cables connecting to the control room. Testing was carried out on June 2, 2015.

SEE Test Set-Up

SEE testing was carried out with the samples in an active configuration. The schematic of the ISL70617SEH SEE test fixture is shown in [Figure 1](#). The indicated 150kΩ R3 (sense resistor) was replaced with a 15kΩ for a gain of 10 and the jumper J13 was not in place. Direct oscilloscope connection to the +V_{OUT} and -V_{OUT} outputs were provided through the 20 foot cables from the irradiation cave to the control room.

Two instantiations of the schematic on a single board allowed two ISL70617SEH to be simultaneously irradiated for SEE testing. The two parts were monitored separately. Parts were in standard flatpack packages but had their lids removed for the SEE testing. For SEB the parts' combined supply currents (IVCC and IVCO and IVEE and IVEO) and output voltages (+V_{OUT} and -V_{OUT}) were monitored for equal inputs (IN+ and IN-) at a rail. For SET testing, the outputs of ±V_{OUT} were both monitored via separate oscilloscopes for transients. The transient trigger was set for ±1V, and any transient reaching 1V or greater deviation triggered an oscilloscope capture that included both outputs. These captures were later reviewed via post processing with MATLAB.

The parts tested came from the First Of Kind (FOK) lot X4H8X using mask set TA54254 on the Intersil PR40 process in FAB59.

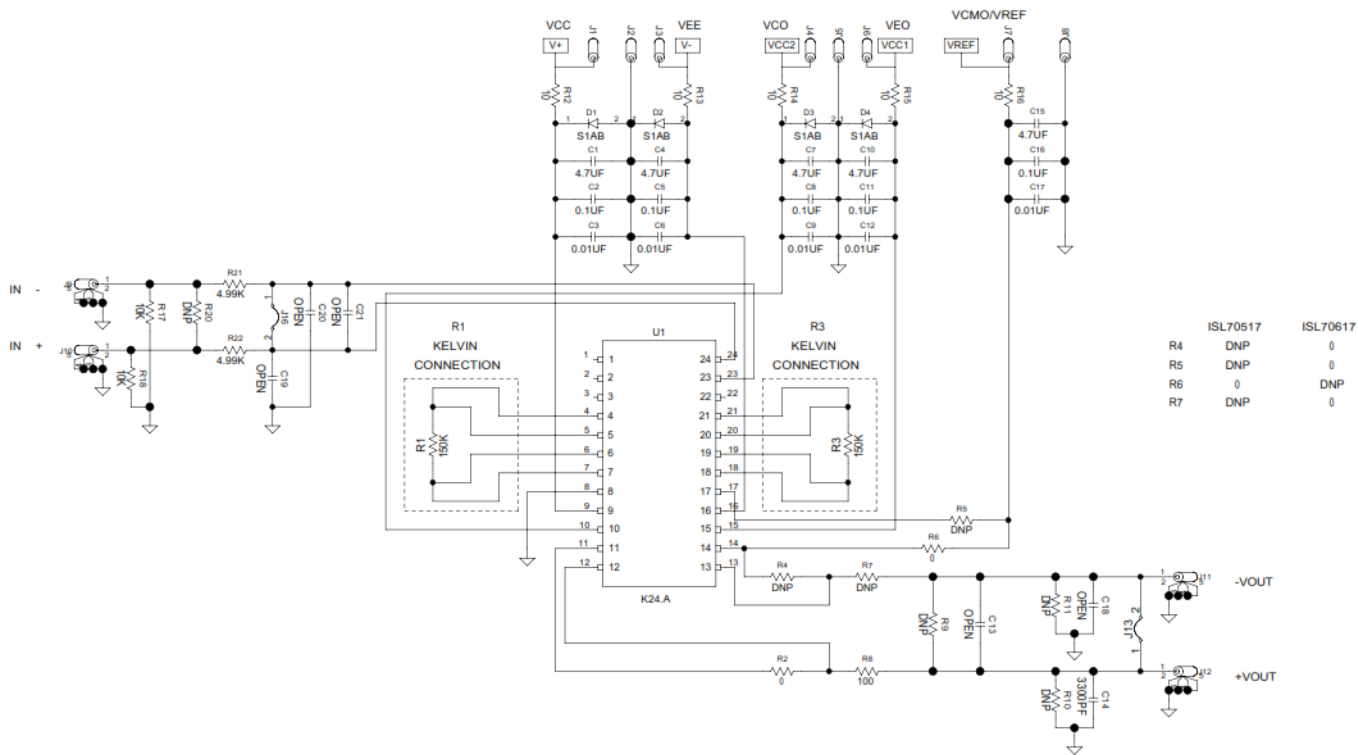

FIGURE 1. SCHEMATIC OF THE ISL70617SEH SEE TEST CONFIGURATION. CONNECTORS GO TO 20 FOOT CABLE TO CONTROL ROOM.

SEB Testing of the ISL70617SEH Instrumentation Amplifier with Pr (LET = 60)

For SEB testing of the ISL70617SEH and ISL70517SEH the input and output supplies were set to equal and symmetric voltages ($\pm V$) and the differential inputs were driven to opposite rails so that the part was under equivalent voltage stress on both the input and output stages. The combined (two DUT's at a time) supply and input currents were measured before and after the irradiations to look for any changes due to irradiation. The output voltages were also monitored for the case of inputs tied together to the negative supply rail. Irradiation for was done with 2.114GeV praseodymium (Pr) at a 10° incidence for an effective LET at the die surface of $60\text{MeV} \cdot \text{cm}^2/\text{mg}$ to a fluence of $5 \times 10^6 \text{ ion}/\text{cm}^2$ at a flux of $2.5 \times 10^4 \text{ ion}/(\text{cm}^2\text{s})$.

For the ISL70617SEH the supply rails were started at $\pm 18\text{V}$ and incremented by 1V on the first pair of DUT's and they survived through $\pm 22\text{V}$. The second pair of ISL70617 started at $\pm 20\text{V}$ and survived through $\pm 22\text{V}$. The summary observations for $\pm 22\text{V}$ biasing case are presented in [Table 1](#) for the currents and [Table 2](#) for the output voltages.

Because the ISL70517SEH is based on the same silicon die as the ISL70617SEH, the SEB testing of the ISL70517SEH started with the supplies at the $\pm 22\text{V}$ setting with the full expectation of achieving the same results as with the ISL70617SEH. The positive results confirming that expectation are presented in [Tables 3](#) and [4](#) on page 3.

It was concluded that for irradiation with ions of $\text{LET} = 60\text{MeV} \cdot \text{cm}^2/\text{mg}$ the parts, both ISL70617SEH and ISL70517SEH did not suffer permanent damage up to supplies and input signals of $\pm 22\text{V}$.

TABLE 1. ISL70617SEH SEB MONITOR FOR $V_{CC} = V_{CO} = 22\text{V}$ and $V_{EE} = V_{EO} = -22\text{V}$ AND $V_{IN+} = 22\text{V}$ AND $V_{IN-} = -22\text{V}$ and EFFECTIVE $\text{LET} = 60\text{MeV} \cdot \text{cm}^2/\text{mg}$ TO A FLUENCE OF $5 \times 10^6 \text{ cm}^2$ WITH $T_{\text{CASE}} = +125^\circ\text{C} \pm 10^\circ\text{C}$.

DEVICES UNDER TEST	TEST	IVCC + IVCO (mA)	IVEE + IVEO (mA)	IIN+ (nA)	IIN- (nA)
DUT1 and DUT2	Pre	14.86	9.76	10.00	4.88
	Post	14.86	9.76	10.03	4.89
DUT3 and DUT4	Pre	14.55	9.44	10.03	4.87
	Post	14.55	9.43	10.04	4.88

TABLE 2. ISL70617SEH SEB MONITOR FOR $V_{CC} = V_{CO} = 22V$ and $V_{EE} = V_{EO} = -22V$ AND $V_{IN+} = 22V$ and $V_{IN-} = -22V$ and EFFECTIVE LET = $60MeV \cdot cm^2/mg$ TO A FLUENCE OF $5 \times 10^6 cm^{-2}$ WITH $T_{CASE} = +125^{\circ}C \pm 10^{\circ}C$. OUTPUT VOLTAGES WERE MEASURED WITH BOTH INPUTS AT $V_{IN+} = V_{IN-} = -22V$.

DEVICES UNDER TEST	TEST	+VOUT (mV)	-VOUT (mV)	DIFFERENCE (mV)
DUT1	Pre	526	520	6
	Post	534	526	8
DUT2	Pre	92	96	-4
	Post	96	94	2
DUT3	Pre	268	264	4
	Post	275	271	4
DUT4	Pre	371	371	0
	Post	379	377	2

TABLE 3. ISL70517SEH SEB MONITOR FOR $V_{CC} = V_{CO} = 22V$ and $V_{EE} = V_{EO} = -22V$ and $V_{IN+} = 22V$ and $V_{IN-} = -22V$ and EFFECTIVE LET = $60MeV \cdot cm^2/mg$ TO A FLUENCE OF $5 \times 10^6 cm^{-2}$ with $T_{CASE} = +125^{\circ}C \pm 10^{\circ}C$.

DEVICES UNDER TEST	TEST	IVCC + IVCO (mA)	IVEE + IVEO (mA)	IIN+ (nA)	IIN- (nA)
DUT1 and DUT2	Pre	17.36	12.37	10.04	4.99
	Post	17.33	12.34	10.04	4.99
DUT3 and DUT4	Pre	17.46	8.54	10.07	4.99
	Post	17.43	8.55	10.09	4.99

TABLE 4. ISL70517SEH SEB MONITOR FOR $V_{CC} = V_{CO} = 22V$ and $V_{EE} = V_{EO} = -22V$ and $V_{IN+} = 22V$ and $V_{IN-} = -22V$ and EFFECTIVE LET = $60MeV \cdot cm^2/mg$ TO A FLUENCE OF $5 \times 10^6 cm^{-2}$ with $T_{CASE} = +125^{\circ}C \pm 10^{\circ}C$. OUTPUT VOLTAGES WERE MEASURED WITH BOTH INPUTS AT $V_{IN+} = V_{IN-} = -22V$.

DEVICES UNDER TEST	TEST	+VOUT (mV)
DUT1	Pre	1180
	Post	1180
DUT2	Pre	168
	Post	174
DUT3	Pre	987
	Post	993
DUT4	Pre	912
	Post	921

SET Testing of the ISL70617SEH Instrumentation Amplifier

SEE testing for non-destructive effects focused on SET of the outputs. SET were critiqued with a $\pm 1V$ trigger on the oscilloscopes, which captured both $+V_{OUT}$ and $-V_{OUT}$ upon triggering on either output. It should be noted that at first it was attempted to take SET data with supplies at $\pm 4V$, but the part immediately went into oscillation when the ion beam started. It was found that increasing the supply to $\pm 5V$ allowed the part to operate without continuous oscillation, but as the data will show

this was an only marginally stable situation. The event counts for the various conditions and units is summarized in [Table 5](#).

Combining the data for the four units tested and calculating the nominal $\pm 1V$ event cross-sections led to the data listed in [Table 6](#). The cross-sections reduced by an order of magnitude when going from $LET = 59MeV \cdot cm^2/mg$ down to $8.5MeV \cdot cm^2/mg$. This extrapolates the $\pm 1V$ SET threshold down to the 2 to $3MeV \cdot cm^2/mg$ range.

TABLE 5. ISL70617SEH $\pm 1V$ SET COUNTS BY OUTPUT, DUT, ION LET, AND SUPPLY VOLTAGES. EACH IRRADIATION WAS TO 4×10^6 ion/cm^2 AT ROOM TEMPERATURE WITH $R_{FB} = 150k\Omega$, $R_{IN} = 15k\Omega$, $V_{IN\pm} = 0V$.

ION LET IN $MeV \cdot cm^2/mg$ AND SUPPLY VOLTAGES	$\pm 1V + V_{OUT}$ SET COUNTS				$\pm 1V - V_{OUT}$ SET COUNTS			
	DUT1	DUT2	DUT3	DUT4	DUT1	DUT2	DUT3	DUT4
LET = 59, $\pm 5V$	1464	1642	1914	1681	1567	1698	1678	1753
LET = 59, $\pm 21V$	1827	1975	2092	2086	1921	2019	1943	2196
LET = 8.5, $\pm 5V$	177	121	292	147	171	125	184	166
LET = 8.5, $\pm 21V$	221	163	305	210	203	169	184	225

TABLE 6. NOMINAL CROSS SECTIONS FOR THE $\pm 1V$ SET EVENTS CAPTURED

ION LET AND SUPPLY VOLTAGES	$\pm 1V$ SET CROSS-SECTIONS (cm^2)	
	+VOUT	-VOUT
LET = 59, $\pm 5V$	4.2E-04	4.2E-04
LET = 59, $\pm 21V$	5.0E-04	5.0E-04
LET = 8.5, $\pm 5V$	4.6E-05	4.0E-05
LET = 8.5, $\pm 21V$	5.6E-05	4.9E-05

SET Traces

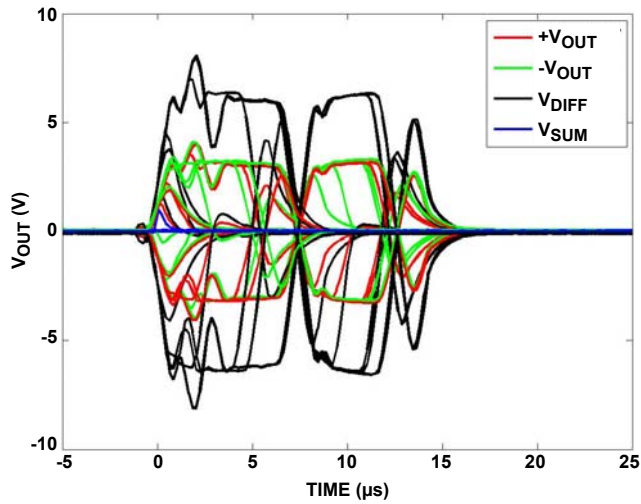

FIGURE 2A.

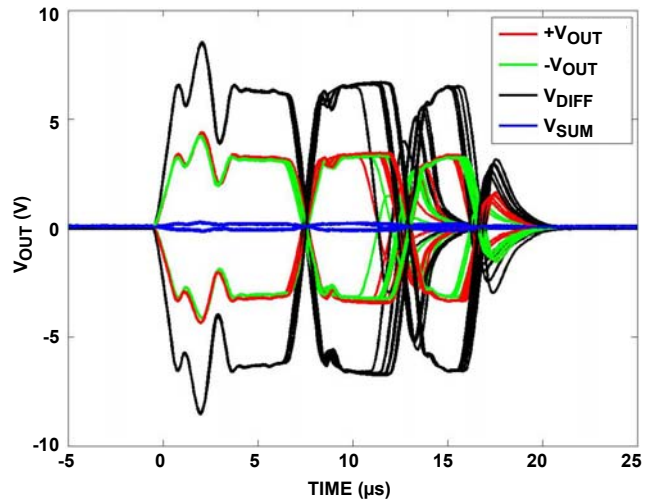

FIGURE 2B.

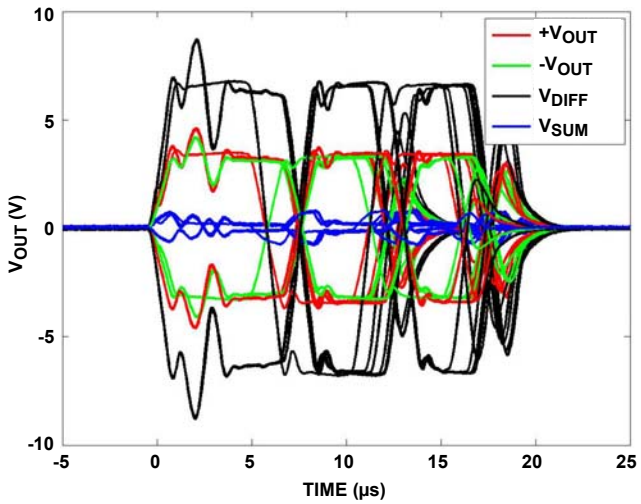

FIGURE 2C.

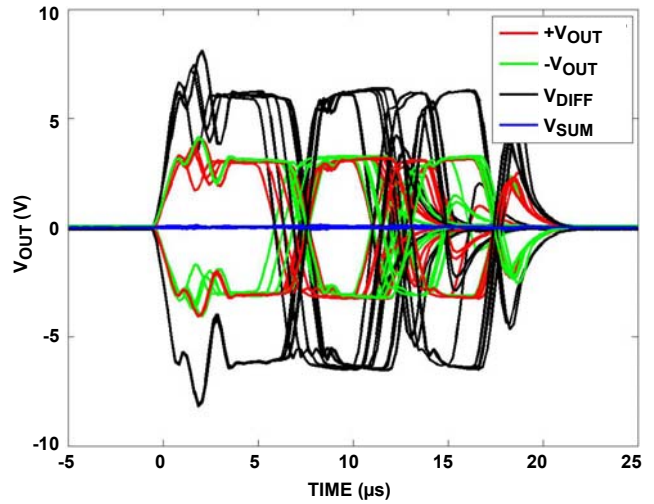

FIGURE 2D.

FIGURE 2. Plots of the 5 largest and longest SET for both polarities of +V_{OUT} maximum deviation for the four parts run at ±5V with LET = 59 MeV • cm²/mg at 2x10⁴ ion/(cm² • s) to 4x10⁶ ion/cm².

SET Traces (Continued)

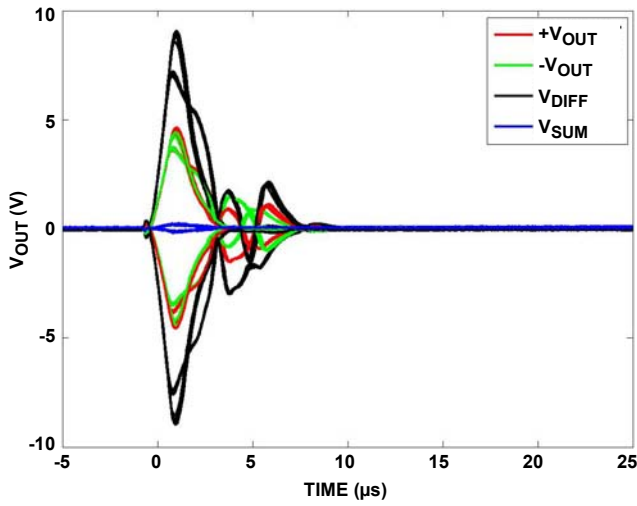

FIGURE 3A.

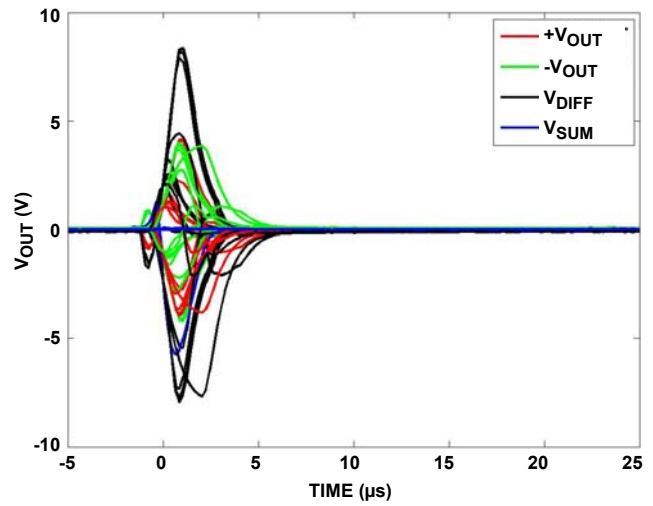

FIGURE 3B.

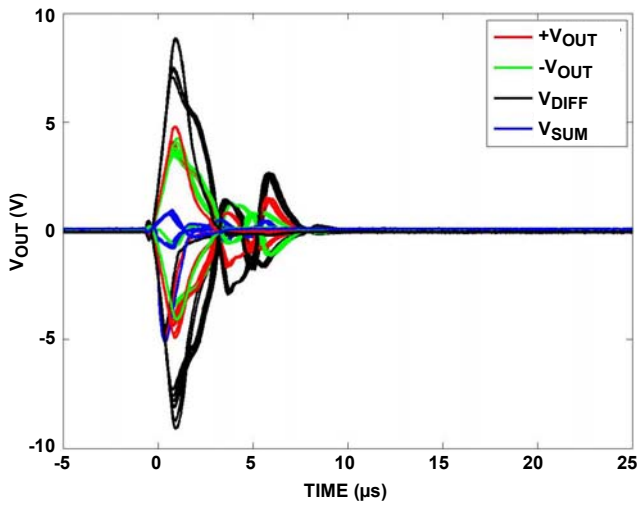

FIGURE 3C.

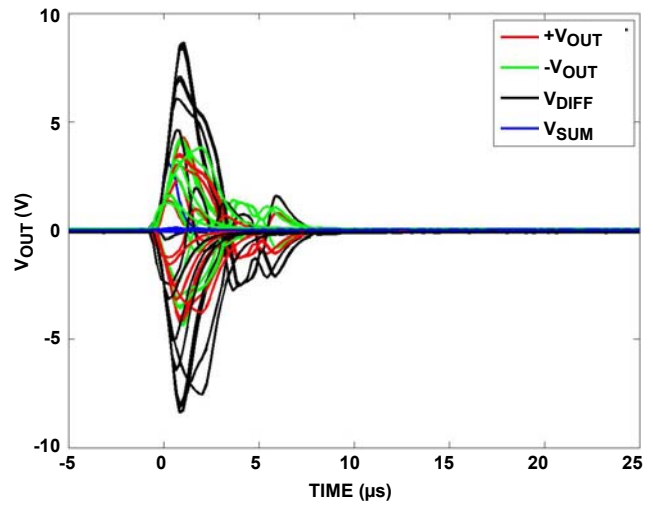

FIGURE 3D.

FIGURE 3. Plots of the 5 largest and longest SET for both polarities of +V_{OUT} maximum deviation for the four parts run at ±21V with LET = 59 MeV • cm²/mg at 2x10⁴ ion/(cm² • s) to 4x10⁶ ion/cm².

SET Traces (Continued)

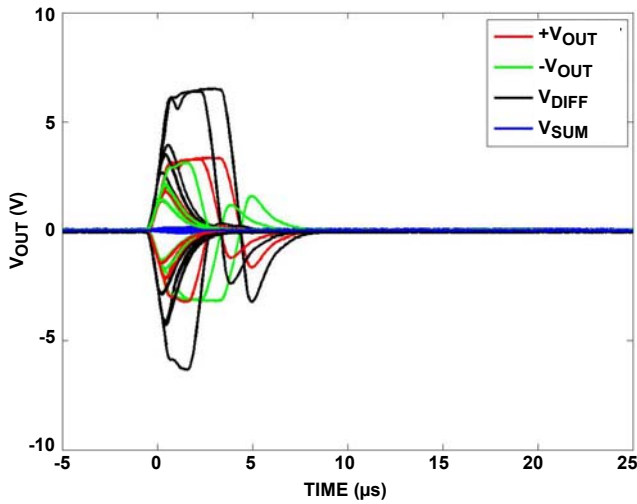

FIGURE 4A.

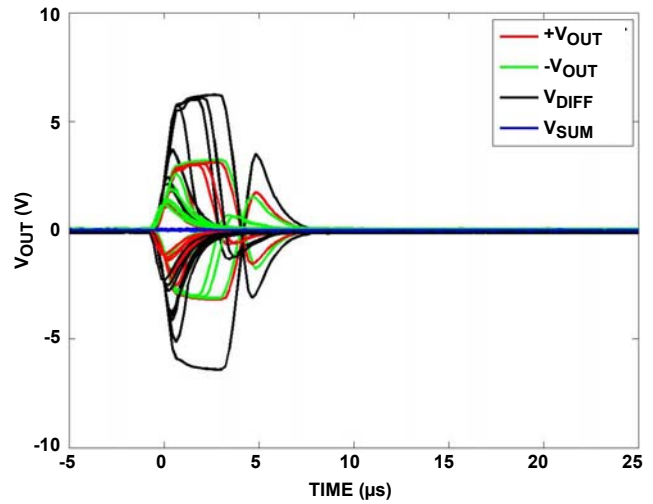

FIGURE 4B.

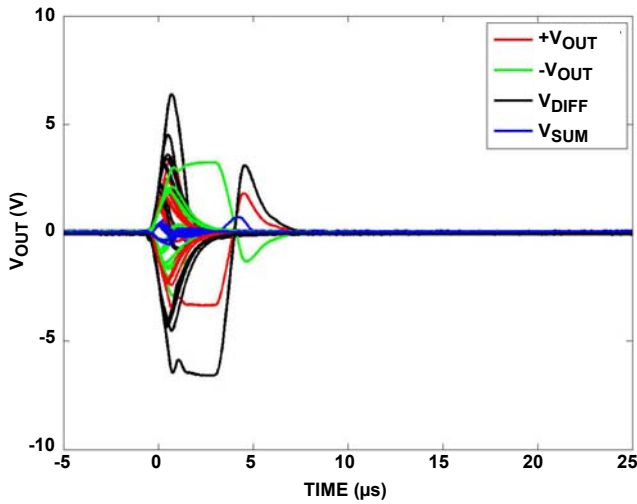

FIGURE 4C.

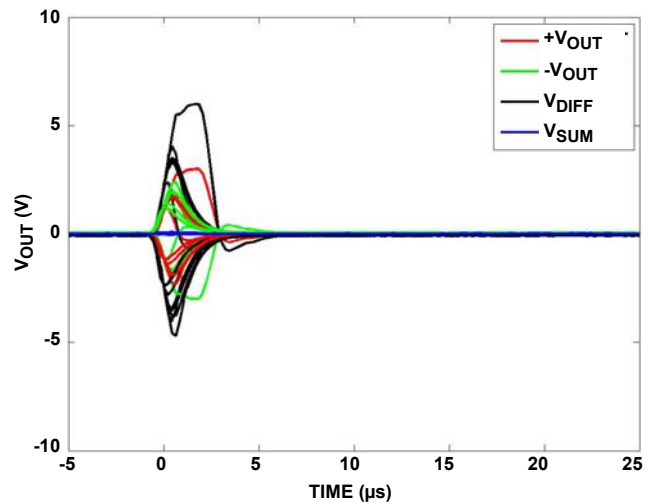

FIGURE 4D.

FIGURE 4. Plots of the 5 largest and longest SET for both polarities of +V_{OUT} maximum deviation for the four parts run at ±5V with LET = 8.5 MeV • cm²/mg at 2x10⁴ ion/(cm²•s) to 4x10⁶ ion/cm².

SET Traces (Continued)

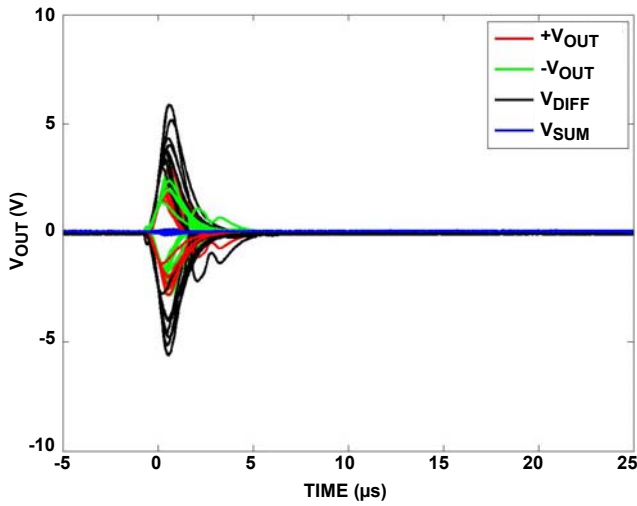

FIGURE 5A.

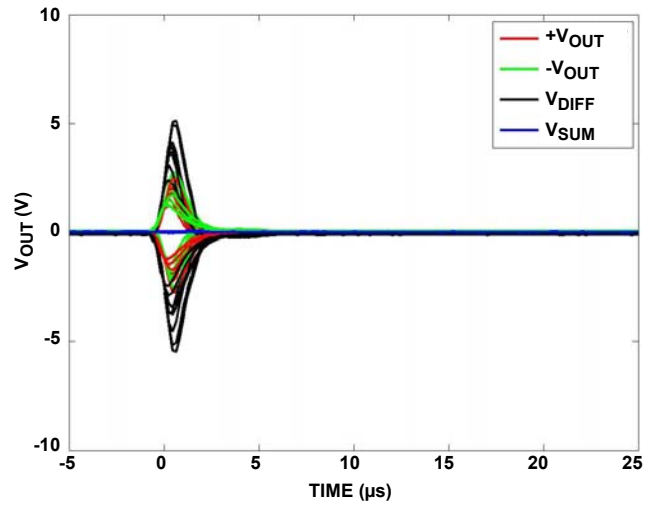

FIGURE 5B.

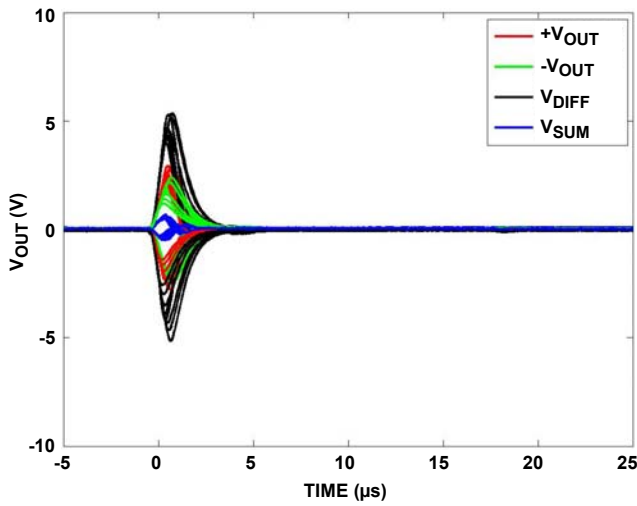

FIGURE 5C.

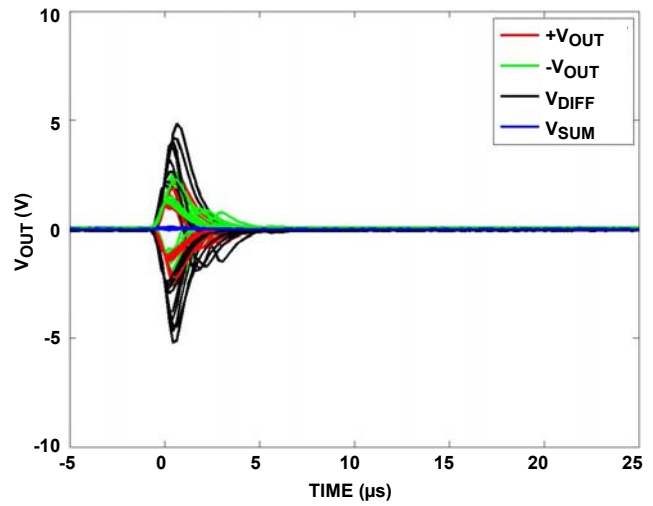

FIGURE 5D.

FIGURE 5. Plots of the 5 largest and longest SET for both polarities of +V_{OUT} maximum deviation 7 for the four parts run at ±21V with LET = 8.5 MeV • cm²/mg at 2x10⁴ ion/(cm²•s) to 4x10⁶ ion/cm².

The captured SET traces were post processed in MATLAB to apply some digital filtering and extract the worst case SET for presentation. Composite plots of the SET are presented in [Figures 2](#) through [5](#).

The SET in [Figure 2](#) takes the distinctive form of a few cycles of an oscillating behavior before the SET proceeds to die out in under 25 μ s. There is some part to part variability evident. This large SET time is more a function of the marginal stability of the part under the test conditions than it is a measure of the actual SET duration. The oscillatory behavior dominates the worst case SET performance. The oscillating behavior prohibited the testing at ± 4 V supplies as the beam created a continuous oscillation, though without the beam no oscillation was observed. This may indicate that lower fluxes are necessary to get true SET performance at the low supply voltages. Noting the near zero common-mode (V_{SUM}) indicates that the differential outputs are reacting oppositely to the SET. The actual SET duration is better measured in the SET data collected at ± 21 V supplies and presented in [Figure 3](#).

At the higher supply settings of ± 21 V the differential SET approaches a 9V magnitude but is not over in 10 μ s duration. Although some SET exhibited some oscillatory behavior, the sustained oscillations seen at the lower supply did not repeat.

The SET results at the lower LET of 8.5MeV \cdot cm²/mg were not only less frequent but also of somewhat more benign magnitude and duration. [Figure 4](#) shows the ± 5 V supply case and shows a reduced but still evident propensity for the oscillatory behavior noted at LET = 59MeV \cdot cm²/mg and ± 5 V. Even with that the SET are over in 10 μ s from onset.

The results for ± 21 V supplies and LET = 8.5MeV \cdot cm²/mg are presented in [Figure 5](#) and show a much reduced magnitude and duration as compared to the results of LET = 59MeV \cdot cm²/mg. In this case the SET are over in approximately 7 μ s and reach a maximum differential magnitude of about 6V.

Conclusions

The ISL70617SEH and ISL70517SEH instrumentation amplifiers are immune to destructive SEE to effective LET = 60MeV \cdot cm²/mg over their full operational voltage range to ± 22 V. This is at least proved true to the composite fluence of 4x10⁷ ions/cm² distributed over four units of each type tested for a nominal cross section limit of less than 1.25x10⁻⁸cm².

The ISL70617SEH is susceptible to large output SET at LET of both 59 and 8.5MeV \cdot cm²/mg. At supplies of ± 5 V the parts exhibited a tendency to oscillate in response to the ion beam and SET, especially at the larger LET. It is believed that the oscillation was a function of the ion beam flux as the parts oscillated continuously at supplies of ± 4 V while the beam was on but did not oscillate without the beam. At ± 21 V supplies the propensity toward oscillatory responses was much reduced if not eliminated.

SET with <1V magnitude on +V_{OUT} (at a gain of 10 with zero inputs) exhibited a cross section of 5x10⁻⁴cm² at LET = 59MeV \cdot cm²/mg and less than 6x10⁻⁵cm² at LET = 8.5MeV \cdot cm²/mg. Extrapolation back from these two points indicates an event threshold of 1.6MeV \cdot cm²/mg. Testing at a lower LET is indicated in order to verify this.

Notice

1. Descriptions of circuits, software and other related information in this document are provided only to illustrate the operation of semiconductor products and application examples. You are fully responsible for the incorporation or any other use of the circuits, software, and information in the design of your product or system. Renesas Electronics disclaims any and all liability for any losses and damages incurred by you or third parties arising from the use of these circuits, software, or information.
2. Renesas Electronics hereby expressly disclaims any warranties against and liability for infringement or any other claims involving patents, copyrights, or other intellectual property rights of third parties, by or arising from the use of Renesas Electronics products or technical information described in this document, including but not limited to, the product data, drawings, charts, programs, algorithms, and application examples.
3. No license, express, implied or otherwise, is granted hereby under any patents, copyrights or other intellectual property rights of Renesas Electronics or others.
4. You shall not alter, modify, copy, or reverse engineer any Renesas Electronics product, whether in whole or in part. Renesas Electronics disclaims any and all liability for any losses or damages incurred by you or third parties arising from such alteration, modification, copying or reverse engineering.
5. Renesas Electronics products are classified according to the following two quality grades: "Standard" and "High Quality". The intended applications for each Renesas Electronics product depends on the product's quality grade, as indicated below.
"Standard": Computers; office equipment; communications equipment; test and measurement equipment; audio and visual equipment; home electronic appliances; machine tools; personal electronic equipment; industrial robots; etc.
"High Quality": Transportation equipment (automobiles, trains, ships, etc.); traffic control (traffic lights); large-scale communication equipment; key financial terminal systems; safety control equipment; etc.
Unless expressly designated as a high reliability product or a product for harsh environments in a Renesas Electronics data sheet or other Renesas Electronics document, Renesas Electronics products are not intended or authorized for use in products or systems that may pose a direct threat to human life or bodily injury (artificial life support devices or systems; surgical implantations; etc.), or may cause serious property damage (space system; undersea repeaters; nuclear power control systems; aircraft control systems; key plant systems; military equipment; etc.). Renesas Electronics disclaims any and all liability for any damages or losses incurred by you or any third parties arising from the use of any Renesas Electronics product that is inconsistent with any Renesas Electronics data sheet, user's manual or other Renesas Electronics document.
6. When using Renesas Electronics products, refer to the latest product information (data sheets, user's manuals, application notes, "General Notes for Handling and Using Semiconductor Devices" in the reliability handbook, etc.), and ensure that usage conditions are within the ranges specified by Renesas Electronics with respect to maximum ratings, operating power supply voltage range, heat dissipation characteristics, installation, etc. Renesas Electronics disclaims any and all liability for any malfunctions, failure or accident arising out of the use of Renesas Electronics products outside of such specified ranges.
7. Although Renesas Electronics endeavors to improve the quality and reliability of Renesas Electronics products, semiconductor products have specific characteristics, such as the occurrence of failure at a certain rate and malfunctions under certain use conditions. Unless designated as a high reliability product or a product for harsh environments in a Renesas Electronics data sheet or other Renesas Electronics document, Renesas Electronics products are not subject to radiation resistance design. You are responsible for implementing safety measures to guard against the possibility of bodily injury, injury or damage caused by fire, and/or danger to the public in the event of a failure or malfunction of Renesas Electronics products, such as safety design for hardware and software, including but not limited to redundancy, fire control and malfunction prevention, appropriate treatment for aging degradation or any other appropriate measures. Because the evaluation of microcomputer software alone is very difficult and impractical, you are responsible for evaluating the safety of the final products or systems manufactured by you.
8. Please contact a Renesas Electronics sales office for details as to environmental matters such as the environmental compatibility of each Renesas Electronics product. You are responsible for carefully and sufficiently investigating applicable laws and regulations that regulate the inclusion or use of controlled substances, including without limitation, the EU RoHS Directive, and using Renesas Electronics products in compliance with all these applicable laws and regulations. Renesas Electronics disclaims any and all liability for damages or losses occurring as a result of your noncompliance with applicable laws and regulations.
9. Renesas Electronics products and technologies shall not be used for or incorporated into any products or systems whose manufacture, use, or sale is prohibited under any applicable domestic or foreign laws or regulations. You shall comply with any applicable export control laws and regulations promulgated and administered by the governments of any countries asserting jurisdiction over the parties or transactions.
10. It is the responsibility of the buyer or distributor of Renesas Electronics products, or any other party who distributes, disposes of, or otherwise sells or transfers the product to a third party, to notify such third party in advance of the contents and conditions set forth in this document.
11. This document shall not be reprinted, reproduced or duplicated in any form, in whole or in part, without prior written consent of Renesas Electronics.
12. Please contact a Renesas Electronics sales office if you have any questions regarding the information contained in this document or Renesas Electronics products.
(Note 1) "Renesas Electronics" as used in this document means Renesas Electronics Corporation and also includes its directly or indirectly controlled subsidiaries.
(Note 2) "Renesas Electronics product(s)" means any product developed or manufactured by or for Renesas Electronics.

(Rev.4.0-1 November 2017)



SALES OFFICES

Renesas Electronics Corporation

<http://www.renesas.com>

Refer to "<http://www.renesas.com/>" for the latest and detailed information.

Renesas Electronics America Inc.
1001 Murphy Ranch Road, Milpitas, CA 95035, U.S.A.
Tel: +1-408-432-8888, Fax: +1-408-434-5351

Renesas Electronics Canada Limited
9251 Yonge Street, Suite 8309 Richmond Hill, Ontario Canada L4C 9T3
Tel: +1-905-237-2004

Renesas Electronics Europe Limited
Dukes Meadow, Millboard Road, Bourne End, Buckinghamshire, SL8 5FH, U.K.
Tel: +44-1628-651-700, Fax: +44-1628-651-804

Renesas Electronics Europe GmbH
Arcadiastrasse 10, 40472 Düsseldorf, Germany
Tel: +49-211-6503-0, Fax: +49-211-6503-1327

Renesas Electronics (China) Co., Ltd.
Room 1709 Quantum Plaza, No.27 ZhichunLu, Haidian District, Beijing, 100191 P. R. China
Tel: +86-10-8235-1155, Fax: +86-10-8235-7679

Renesas Electronics (Shanghai) Co., Ltd.
Unit 301, Tower A, Central Towers, 555 Langao Road, Putuo District, Shanghai, 200333 P. R. China
Tel: +86-21-2226-0888, Fax: +86-21-2226-0999

Renesas Electronics Hong Kong Limited
Unit 1601-1611, 16/F., Tower 2, Grand Century Place, 193 Prince Edward Road West, Mongkok, Kowloon, Hong Kong
Tel: +852-2265-6688, Fax: +852-2886-9022

Renesas Electronics Taiwan Co., Ltd.
13F, No. 363, Fu Shing North Road, Taipei 10543, Taiwan
Tel: +886-2-8175-9600, Fax: +886-2-8175-9670

Renesas Electronics Singapore Pte. Ltd.
80 Bendemeer Road, Unit #06-02 Hyflux Innovation Centre, Singapore 339949
Tel: +65-6213-0200, Fax: +65-6213-0300

Renesas Electronics Malaysia Sdn.Bhd.
Unit 1207, Block B, Menara Amcorp, Amcorp Trade Centre, No. 18, Jln Persiaran Barat, 46050 Petaling Jaya, Selangor Darul Ehsan, Malaysia
Tel: +60-3-7955-9390, Fax: +60-3-7955-9510

Renesas Electronics India Pvt. Ltd.
No.777C, 100 Feet Road, HAL 2nd Stage, Indiranagar, Bangalore 560 038, India
Tel: +91-80-67208700, Fax: +91-80-67208777

Renesas Electronics Korea Co., Ltd.
17F, KAMCO Yangjae Tower, 262, Gangnam-daero, Gangnam-gu, Seoul, 06265 Korea
Tel: +82-2-558-3737, Fax: +82-2-558-5338