

ISL71841SEH

Total Dose Testing

TR011
Rev 1.01
Dec 8, 2022

Introduction

This report provides results of a low and high dose rate total dose test of the [ISL71841SEH](#) 32-channel analog multiplexer. The test was conducted in order to determine the sensitivity of the part to the total dose environment and to determine if any dose rate sensitivity exists. High and low dose rate testing under bias and with all pins grounded is complete through 150krad(Si) and a subsequent high temperature biased anneal for 168 hours at +100°C. The reported results for the base ISL71841SEH also apply to the ISL73841SEH variant. The parts are available in the same packages. They only differ in final TID acceptance testing.

Reference Documents

- MIL-STD-883 test method 1019
- [ISL71841SEH](#) datasheet.
- Standard Microcircuit Drawing (SMD) [5962-15220](#)

Part Description

The ISL71841SEH is a radiation hardened 32-channel analog multiplexer that is fabricated using the proprietary P6SOI Silicon on Insulator (SOI) process to mitigate single-event effects and improve total ionizing dose performance. The part operates from a dual supply voltage ranging from ±10.8V to ±16.5V and has five address inputs and an ENABLE pin that can be driven with adjustable logic thresholds to select 1 of 32 available channels. An inactive channel is separated from an active channel by high impedance, which inhibits any interaction between them. The ISL71841SEH's low switch ON-resistance (r_{ON}) allows improved signal integrity and reduced power losses. The ISL71841SEH is also designed for cold sparing, making it suitable for high reliability applications that have redundancy requirements. The part is designed to provide a high impedance to the analog source while in a powered OFF condition, making it easy to add additional backup devices without loading signal sources. The ISL71841SEH also incorporates input analog overvoltage protection up to ±35V, which will disable the switch to protect downstream devices. All inputs are Electrostatic Discharge (ESD) protected to 8kV Human Body Model (HBM). The ISL71841SEH is available in a 48 Ld package ceramic quad flatpack or in die form and operates across the extended temperature range of -55°C to +125°C.

As the 32-channel ISL71841SEH analog multiplexer is an evolution of several earlier 16-channel devices, a brief historical note may be in order. The first Renesas 16-channel analog multiplexer was the HS-1840RH. This part was built in an early dielectrically isolated metal gate CMOS process and was obsoleted in the 1995 time frame.

The HS-1840RH was followed by the HS-1840ARH, which was designed in the later dielectrically isolated RSG process and was developed in order to continue supplying this very popular part, which performs a key function in many space systems. As part of the redesign the HS-1840ARH gained some functionality made possible by the bipolar devices available in RSG, which the metal gate process did not support. Bipolar circuit blocks in the HS-1840ARH included the on-chip voltage reference, the digital input ESD network and the VDD and VSS ESD nets.

The ISL71841SEH is the subject of the present report and was designed as a 32-channel version of the ISL71840SEH, sharing improvements in the switch ON-resistance and in cold sparing capabilities with that part. A block diagram is shown in [Figure 1 on page 2](#). Dec 8, 2022

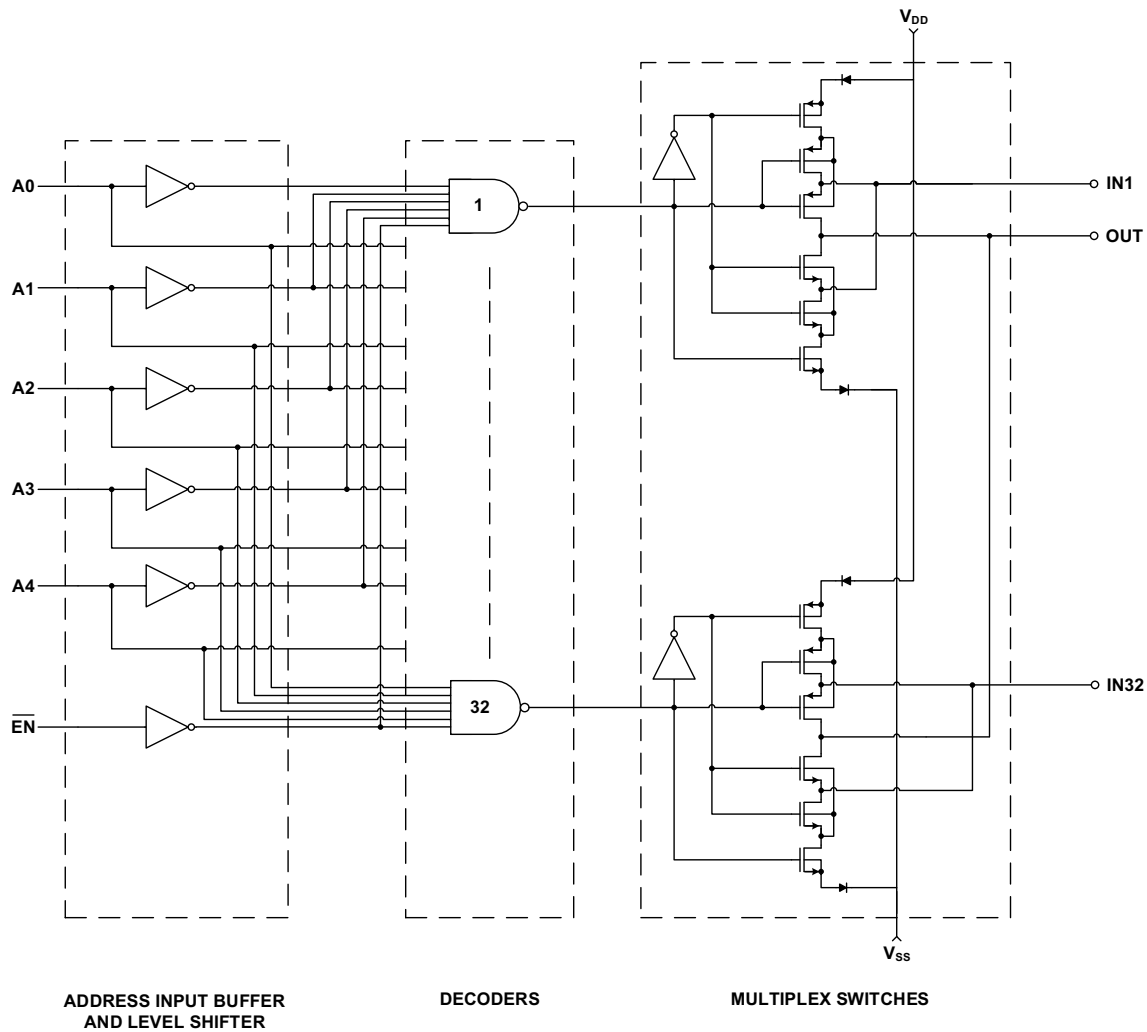

FIGURE 1. ISL71841SEH BLOCK DIAGRAM

Test Description

Irradiation Facilities

High dose rate testing was performed at 69.7rad(Si)/s using a Gamma cell 220⁶⁰Co irradiator located in the Palm Bay, Florida Renesas facility. Low dose rate testing was performed at 0.0089rad(Si)/s using a Hopewell Designs N40 panoramic low dose rate ⁶⁰Co irradiator located in the same facility. The irradiations were performed in accordance with MIL-STD-883 Method 1019. The low dose rate exposures used a PbAl box to shield the test board and devices under test against low energy secondary gamma radiation as required by TM1019. The biased anneals were carried out in a small temperature chamber.

Test Fixturing

[Figure 2 on page 3](#) shows the configuration and power supply sequencing used for biased irradiation.

233032-005-665

ISL71841 (HDR/LDR) Mask # 54253A01

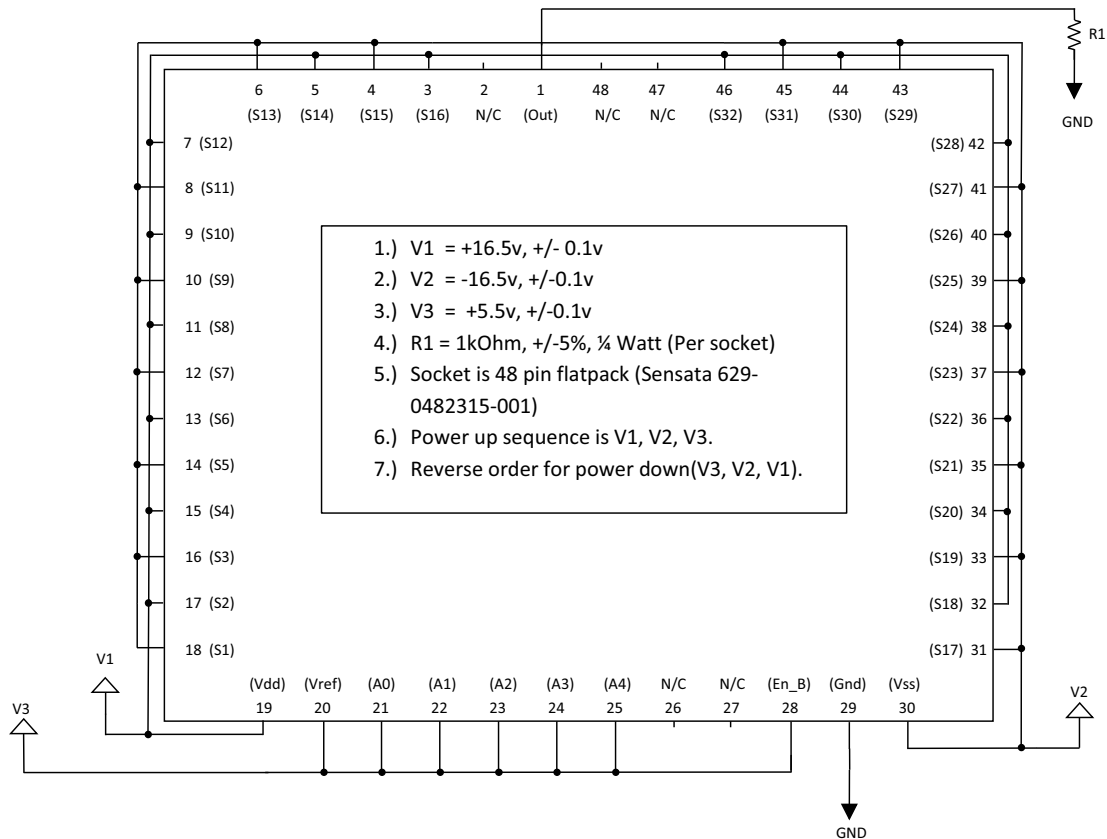

FIGURE 2. IRRADIATION BIAS CONFIGURATION AND POWER SUPPLY SEQUENCING FOR THE ISL71841SEH

Characterization Equipment and Procedures

All electrical testing was performed outside the irradiator using production Automated Test Equipment (ATE) with datalogging of all parameters at each downpoint. All downpoint electrical testing was performed at room temperature.

Experimental Matrix

Testing proceeded in accordance with the guidelines of MIL-STD-883 TM1019. The experimental matrix consisted of four samples irradiated at high dose rate under bias, four samples irradiated at high dose rate with all pins grounded, five samples irradiated at low dose rate under bias and five samples irradiated at low dose rate with all pins grounded. Three control units were used to insure repeatable data (See [Table 1](#)).

Samples of the ISL71841SEH were drawn from wafers, 2 (high dose rate samples) and wafers 1, 2 and 5 (low dose rate samples) from development lot J67669 and were packaged in the production hermetic quad flatpack package outline K48.A. The samples were processed through the standard burn-in cycle and were screened to the SMD 5962-15220 electrical limits at room, low and high temperatures before irradiation.

Downpoints

Downpoints for the low dose rate tests were zero, 10krad(Si), 30krad(Si), 50krad(Si), 100krad(Si) and 150krad(Si). Downpoints for the high dose rate test were zero, 30krad(Si), 50krad(Si), 100krad(Si) and 150krad(Si). All samples were subjected to a high temperature biased anneal for 168 hours at +100 °C following irradiation, using the [Figure 2](#) bias configuration.

Results

Attributes Data

[Table 1 on page 4](#) summarizes the results of total dose testing of the ISL71841SEH.

TABLE 1. ISL71841SEH TOTAL DOSE TEST ATTRIBUTES DATA

DOSE RATE	BIAS	SAMPLE SIZE	DOWNPOINT	BIN 1	REJECTS
0.0085rad(Si)/s	Figure 2	13	Preirradiation	13	
			10krad(Si)	13	0
			30krad(Si)	13	0
			50krad(Si)	13	0
			100krad(Si)	13	0
			150krad(Si)	13	0
			Anneal, 168 hours at +100 °C	10	3
0.0085rad(Si)/s	Grounded	13	Preirradiation	13	
			10krad(Si)	13	0
			30krad(Si)	13	0
			50krad(Si)	13	0
			100krad(Si)	13	0
			150krad(Si)	12	1
			Anneal, 168 hours at +100 °C	11	2
69.7rad(Si)/s	Figure 2	4	Preirradiation	4	
			30krad(Si)	4	0
			50krad(Si)	4	0
			100krad(Si)	4	0
			150krad(Si)	4	0
			Anneal, 168 hours at +100 °C	4	0
69.7rad(Si)/s	Grounded	4	Preirradiation	4	
			30krad(Si)	4	0
			50krad(Si)	4	0
			100krad(Si)	4	0
			150krad(Si)	4	0
			Anneal, 168 hours at +100 °C	4	0

NOTES:

1. Bin 1 indicates a device that passes all preirradiation specification limits.
2. The 168 hours anneal was performed at +100 °C using the bias configuration shown in [Figure 2](#).

Variables Data

The plots in [Figures 3](#) through [44](#) show data at all downpoints. The plots show the population median of key parameters as a function of total dose for each of the four irradiation conditions. We chose to plot the median because of the small sample sizes involved and also because the very tight distributions for all parameters. The exceptions to this approach are the plots for the ON-resistance flatness; this parameter showed failures at the 150krad(Si) low dose rate level and after anneal. We show the population median ([Figure 12](#)) for both dose rates, the median and minimum/maximum error bars for the low dose rate case

([Figure 13](#)) and the median and minimum/maximum error bars for the high dose rate case ([Figure 14](#)).

Most of the plots show the total dose response of the average of the medians of each of the 32 channels of parameters such as ON-resistance, the digital input parameters and the various leakage parameters for each of the 32 channels in order to facilitate the interpretation of the results as well as managing the length of this report. See conclusion on [page 47](#) for further discussion.

Variables Data Plots

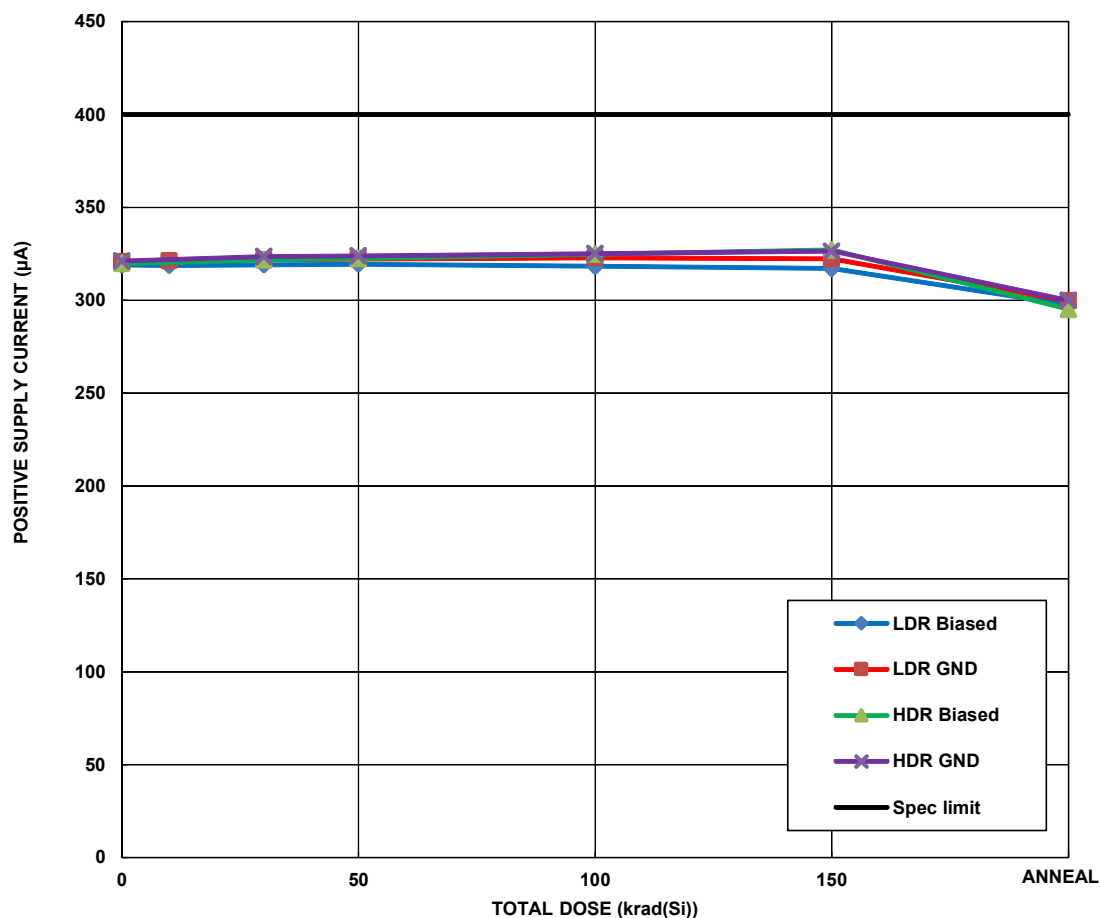

FIGURE 3. Median ISL71841SEH positive supply current as a function of total dose irradiation at high and low dose rate for the biased (per [Figure 2](#)) and unbiased (all pins grounded) cases. The low dose rate was 0.0085rad(Si)/s and the high dose rate was 69.7rad(Si)/s. Irradiations were followed by a 168-hour biased anneal at +100 °C. Sample size for the low dose rate cells was 13 and sample size for the high dose rate cells was 4. The post-irradiation SMD limit is 400µA maximum.

Variables Data Plots (Continued)

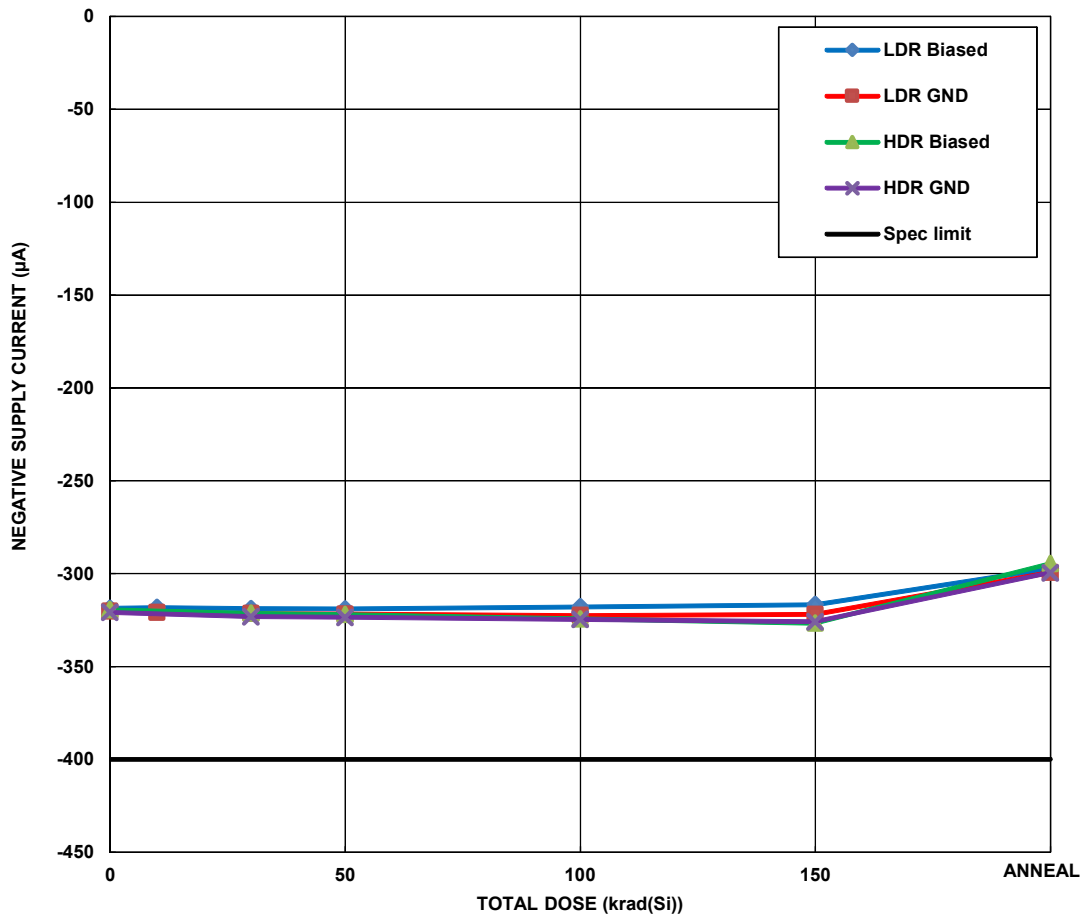

FIGURE 4. Median ISL71841SEH negative supply current as a function of total dose irradiation at high and low dose rate for the biased (per Figure 2) and unbiased (all pins grounded) cases. The low dose rate was 0.0085rad(Si)/s and the high dose rate was 69.7rad(Si)/s. Irradiations were followed by a 168-hour biased anneal at +100 °C. Sample size for the low dose rate cells was 13 and sample size for the high dose rate cells was 4. The post-irradiation SMD limit is -400µA minimum.

Variables Data Plots (Continued)

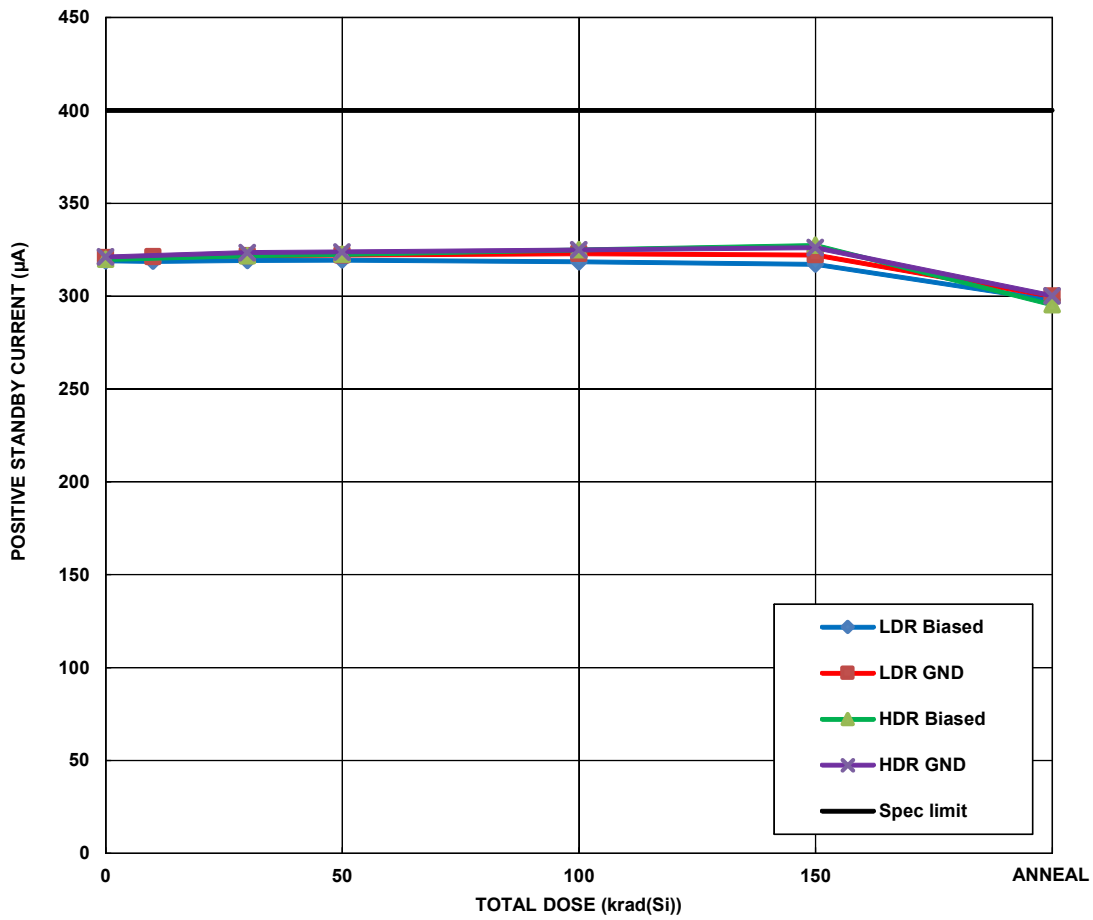

FIGURE 5. Median ISL71841SEH positive standby current as a function of total dose irradiation at high and low dose rate for the biased (per [Figure 2](#)) and unbiased (all pins grounded) cases. The low dose rate was 0.0085rad(Si)/s and the high dose rate was 69.7rad(Si)/s. Irradiations were followed by a 168-hour biased anneal at +100° C. Sample size for the low dose rate cells was 13 and sample size for the high dose rate cells was 4. The post-irradiation SMD limit is 400µA maximum.

Variables Data Plots (Continued)

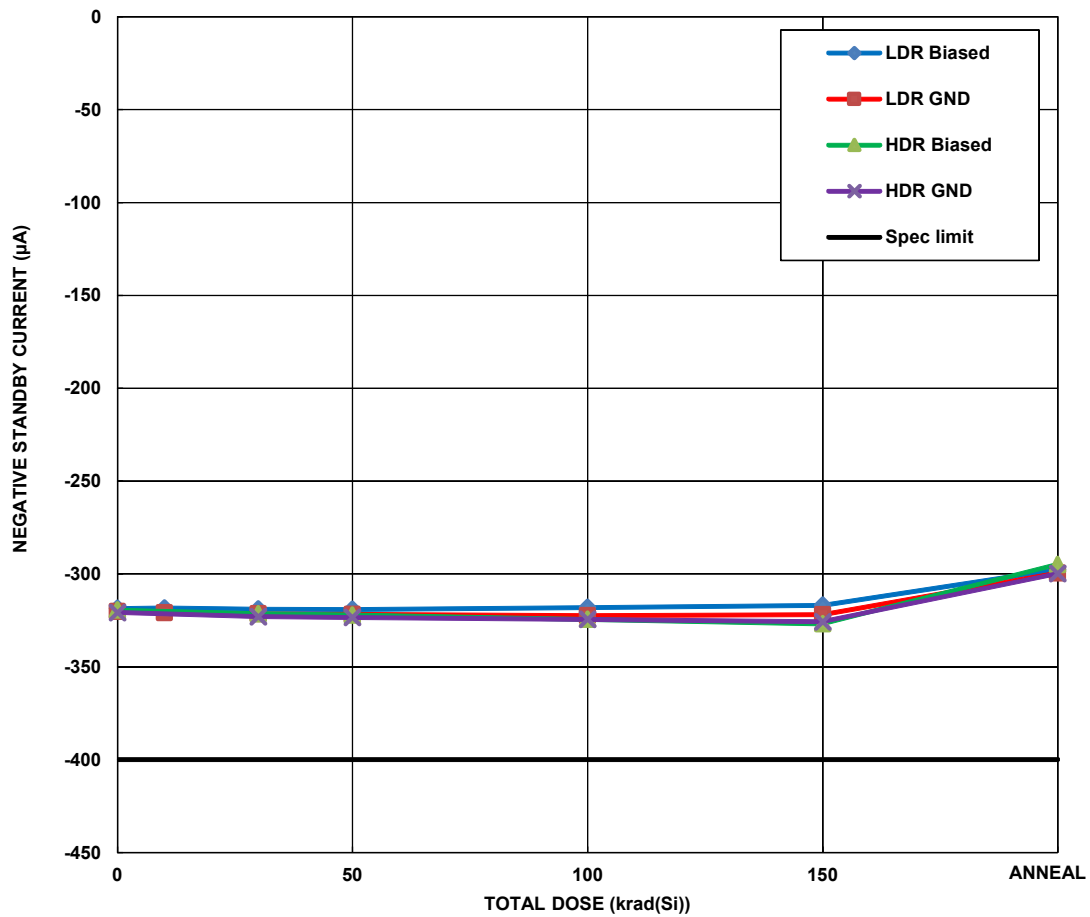

FIGURE 6. Median ISL71841SEH negative standby current as a function of total dose irradiation at high and low dose rate for the biased (per Figure 2) and unbiased (all pins grounded) cases. The low dose rate was 0.0085rad(Si)/s and the high dose rate was 69.7rad(Si)/s. Irradiations were followed by a 168-hour biased anneal at +100 °C. Sample size for the low dose rate cells was 13 and sample size for the high dose rate cells was 4. The post-irradiation SMD limit is -400µA minimum.

Variables Data Plots (Continued)

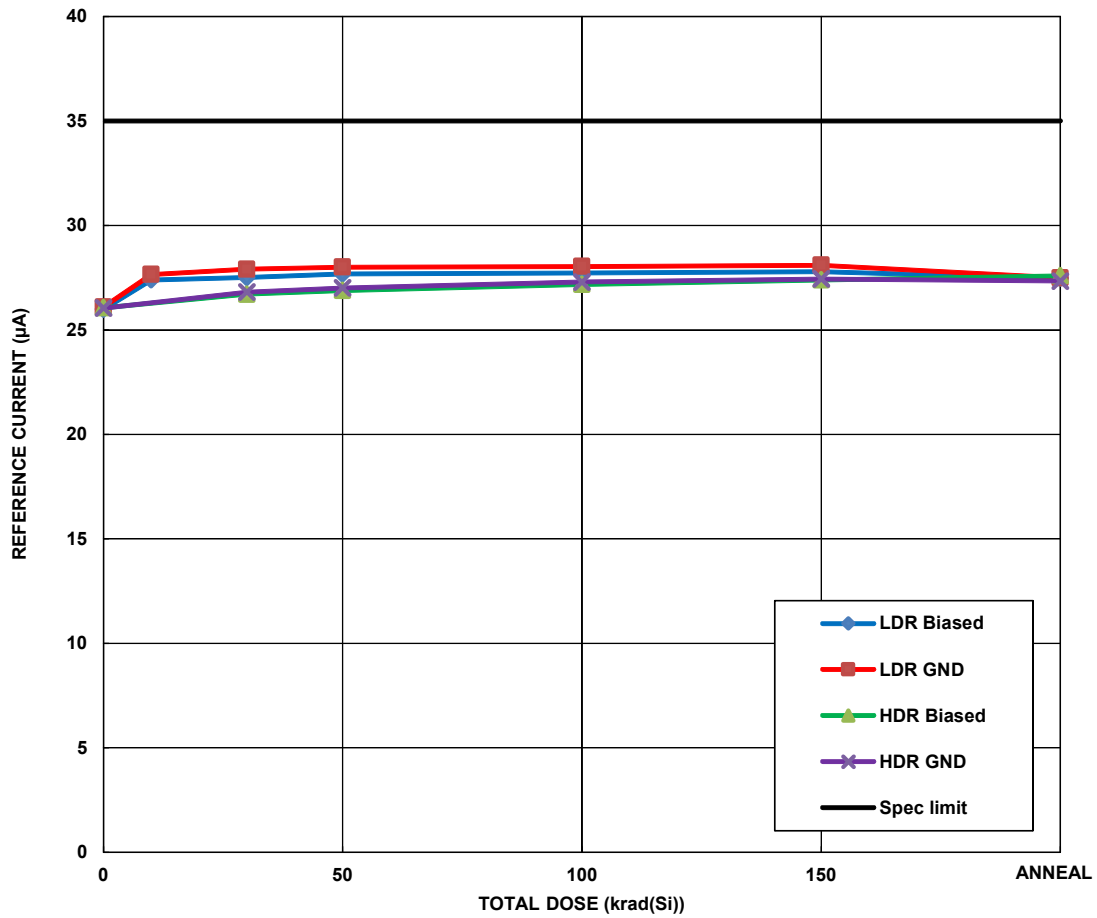

FIGURE 7. Median ISL71841SEH reference current as a function of total dose irradiation at high and low dose rate for the biased (per Figure 2) and unbiased (all pins grounded) cases. The low dose rate was 0.0085rad(Si)/s and the high dose rate was 69.7rad(Si)/s. Irradiations were followed by a 168-hour biased anneal at +100°C. Sample size for the low dose rate cells was 13 and sample size for the high dose rate cells was 4. The post-irradiation SMD limit is 35µA maximum.

Variables Data Plots (Continued)

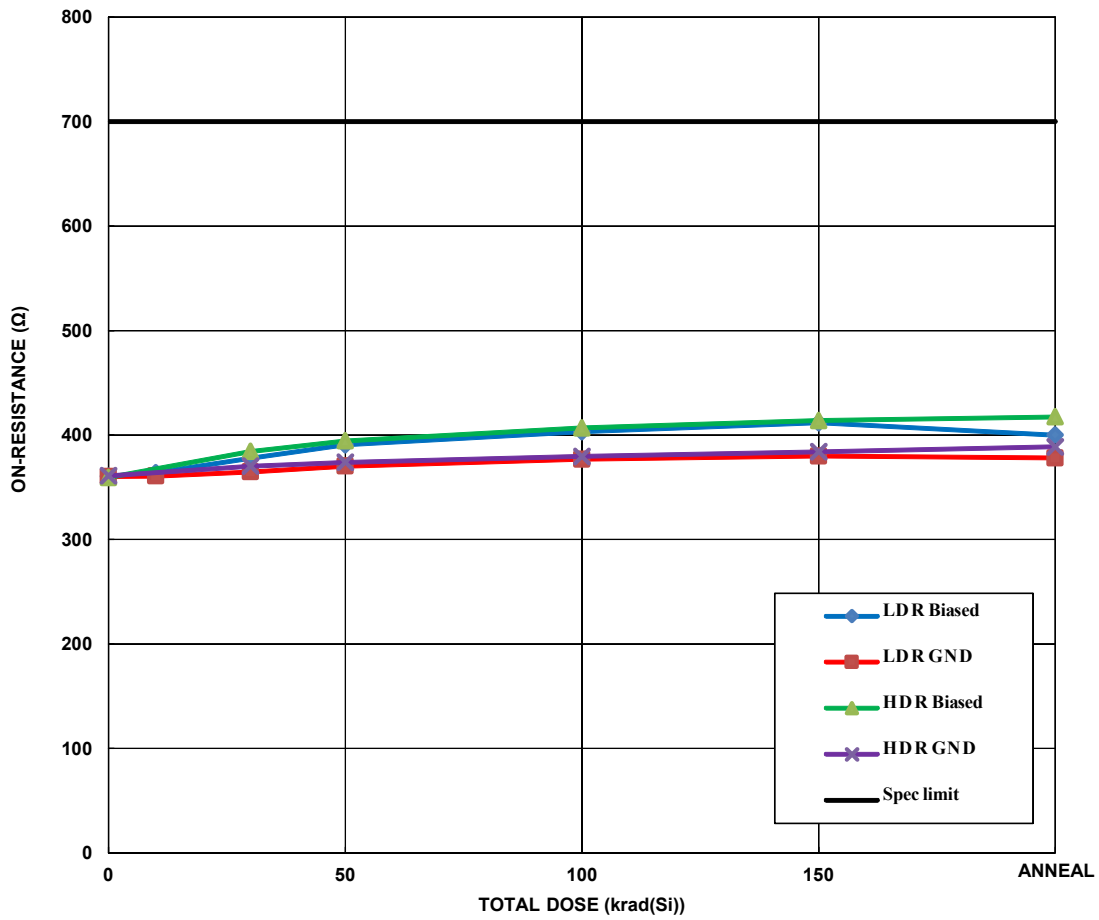

FIGURE 8. ISL71841SEH ON-resistance, average of the medians of all 32 channels, ±15 V supplies, 1.0mA output current, 15.0V input voltage, as a function of total dose irradiation at high and low dose rate for the biased (Figure 2) and unbiased (all pins grounded) cases. The low dose rate was 0.0085rad(Si)/s and the high dose rate was 69.7rad(Si)/s. Irradiations were followed by a 168-hour biased anneal at +100° C. Sample size for the low dose rate cells was 13 and sample size for the high dose rate cells was 4. The post-irradiation SMD limit is 700Ω maximum.

Variables Data Plots (Continued)

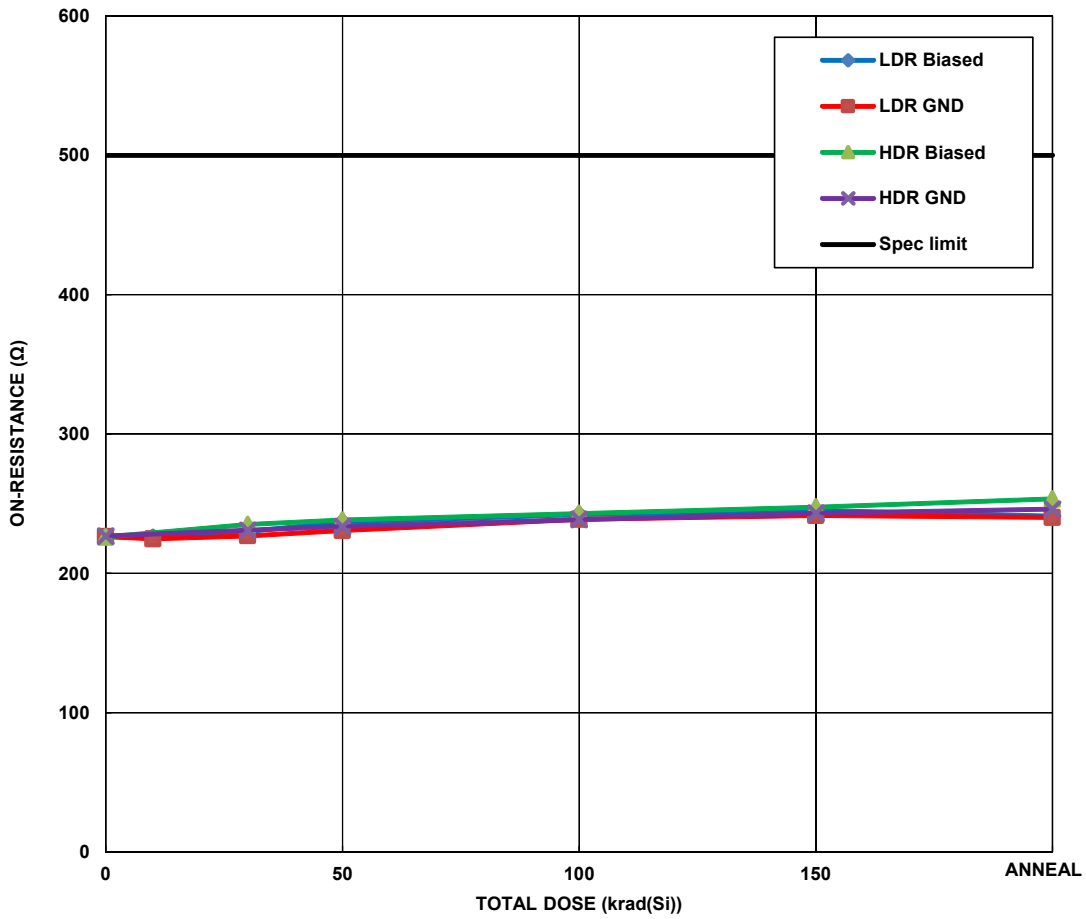

FIGURE 9. ISL71841SEH ON-resistance, average of the medians of all 32 channels, ±15 V supplies, 1.0mA output current, 5.0V input voltage, as a function of total dose irradiation at high and low dose rate for the biased (Figure 2) and unbiased (all pins grounded) cases. The low dose rate was 0.0085rad(Si)/s and the high dose rate was 69.7rad(Si)/s. Irradiations were followed by a 168-hour biased anneal at +100 °C. Sample size for the low dose rate cells was 13 and sample size for the high dose rate cells was 4. The post-irradiation SMD limit is 500Ω maximum.

Variables Data Plots (Continued)

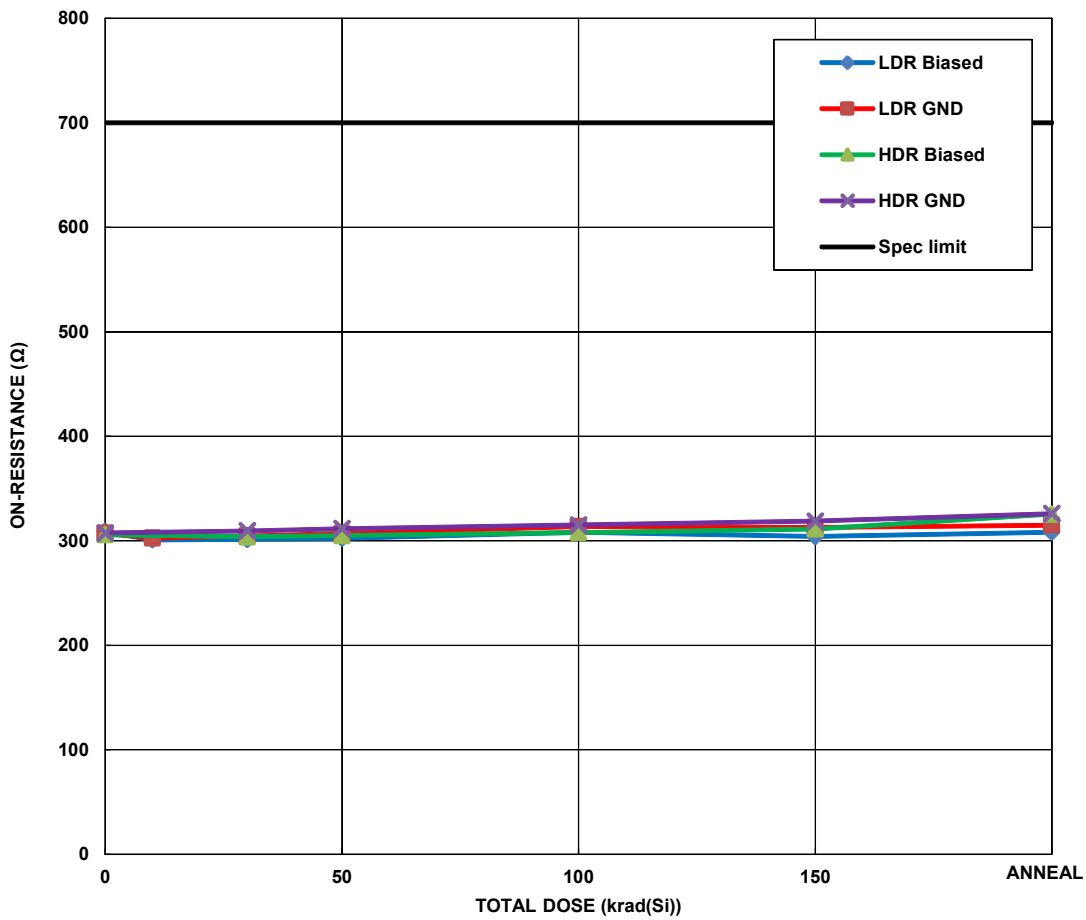

FIGURE 10. ISL71841SEH ON-resistance, average of the medians of all 32 channels, ±15V supplies, 1.0mA output current, -15.0V input voltage, as a function of total dose irradiation at high and low dose rate for the biased (Figure 2) and unbiased (all pins grounded) cases. The low dose rate was 0.0085rad(Si)/s and the high dose rate was 69.7rad(Si)/s. Irradiations were followed by a 168-hour biased anneal at +100°C. Sample size for the low dose rate cells was 13 and sample size for the high dose rate cells was 4. The post-irradiation SMD limit is 700Ω maximum.

Variables Data Plots (Continued)

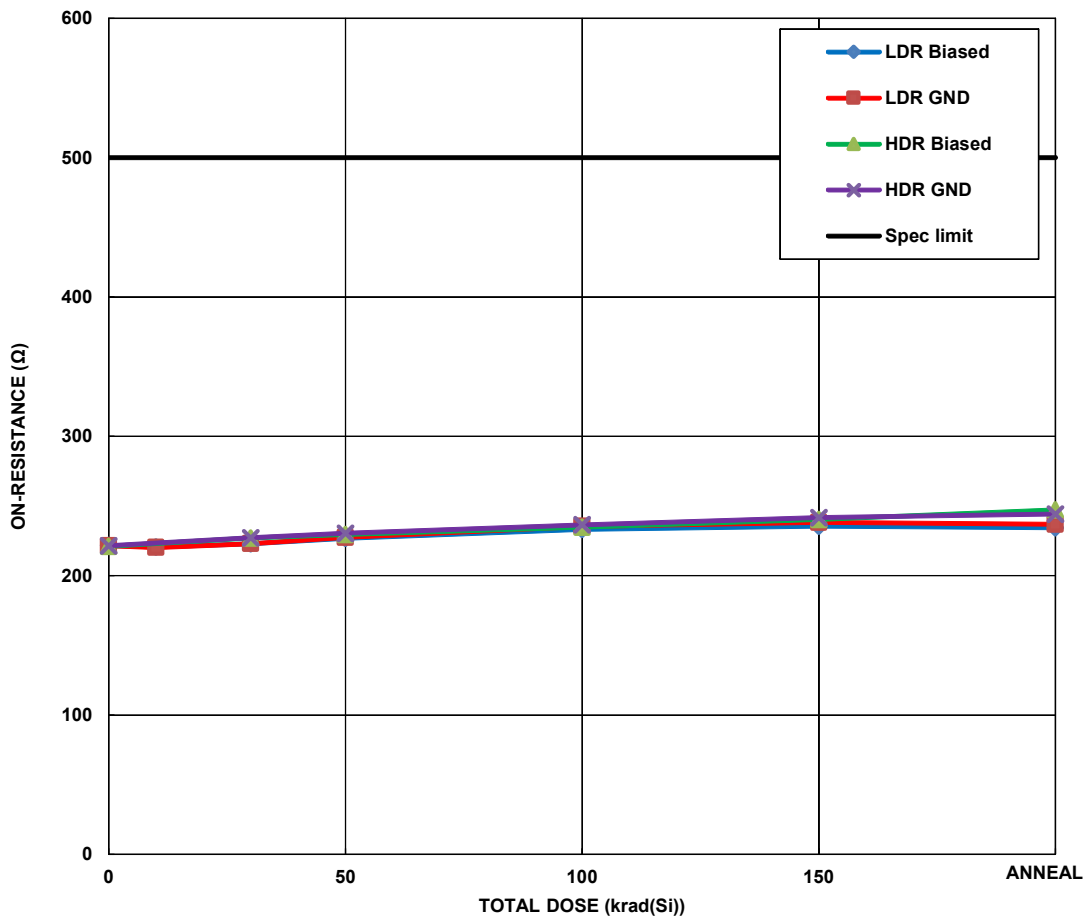

FIGURE 11. ISL71841SEH ON resistance, average of the medians of all 32 channels, ±15V supplies, 1.0mA output current, -5.0V input voltage, as a function of total dose irradiation at high and low dose rate for the biased (Figure 2) and unbiased (all pins grounded) cases. The low dose rate was 0.0085rad(Si)/s and the high dose rate was 69.7rad(Si)/s. Irradiations were followed by a 168-hour biased anneal at +100 °C. Sample size for the low dose rate cells was 13 and sample size for the high dose rate cells was 4. The post-irradiation SMD limit is 500Ω maximum.

Variables Data Plots (Continued)

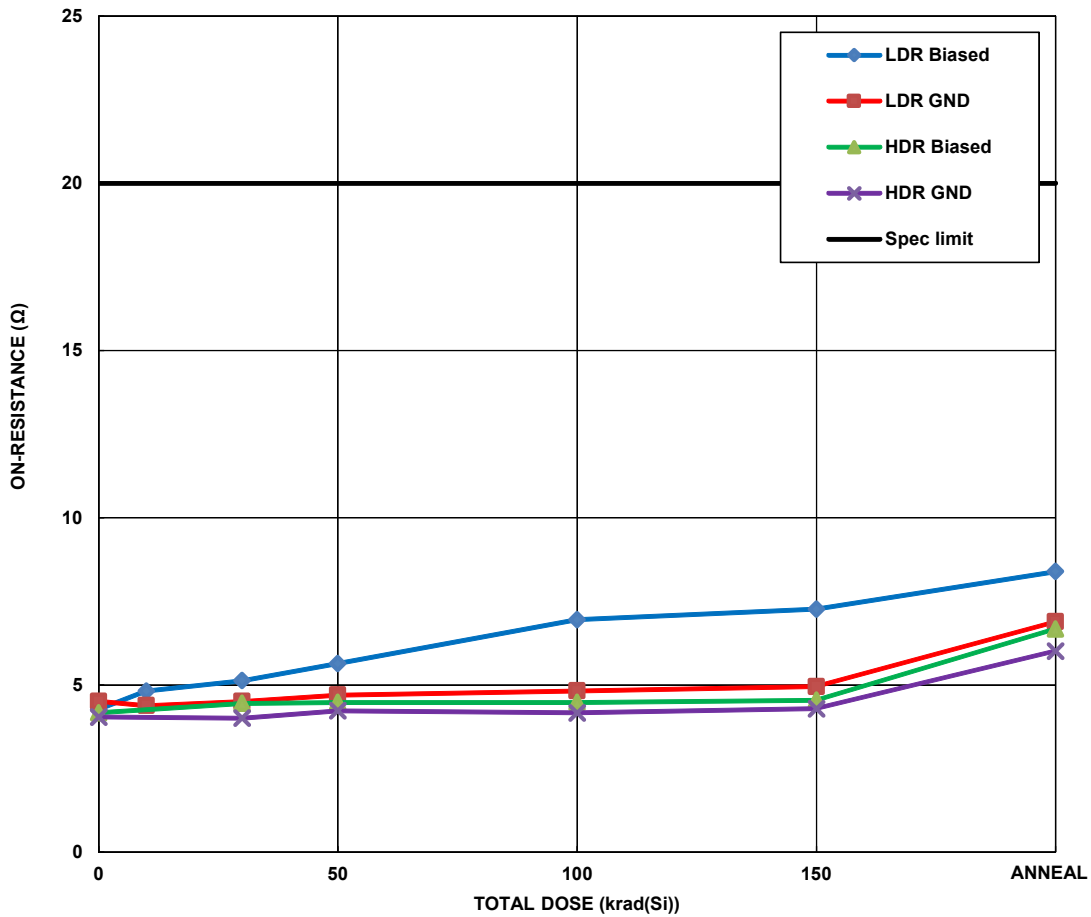

FIGURE 12. ISL71841SEH ON resistance match, average of the medians of all 32 channels, ±15V supplies, -1.0mA output current, +5.0V input voltage, as a function of total dose irradiation at high and low dose rate for the biased (Figure 2) and unbiased (all pins grounded) cases. The low dose rate was 0.0085rad(Si)/s and the high dose rate was 69.7rad(Si)/s. Irradiations were followed by a 168-hour biased anneal at +100 °C. Sample size for the low dose rate cells was 13 and sample size for the high dose rate cells was 4. The post-irradiation SMD limit is 20Ω maximum.

Variables Data Plots (Continued)

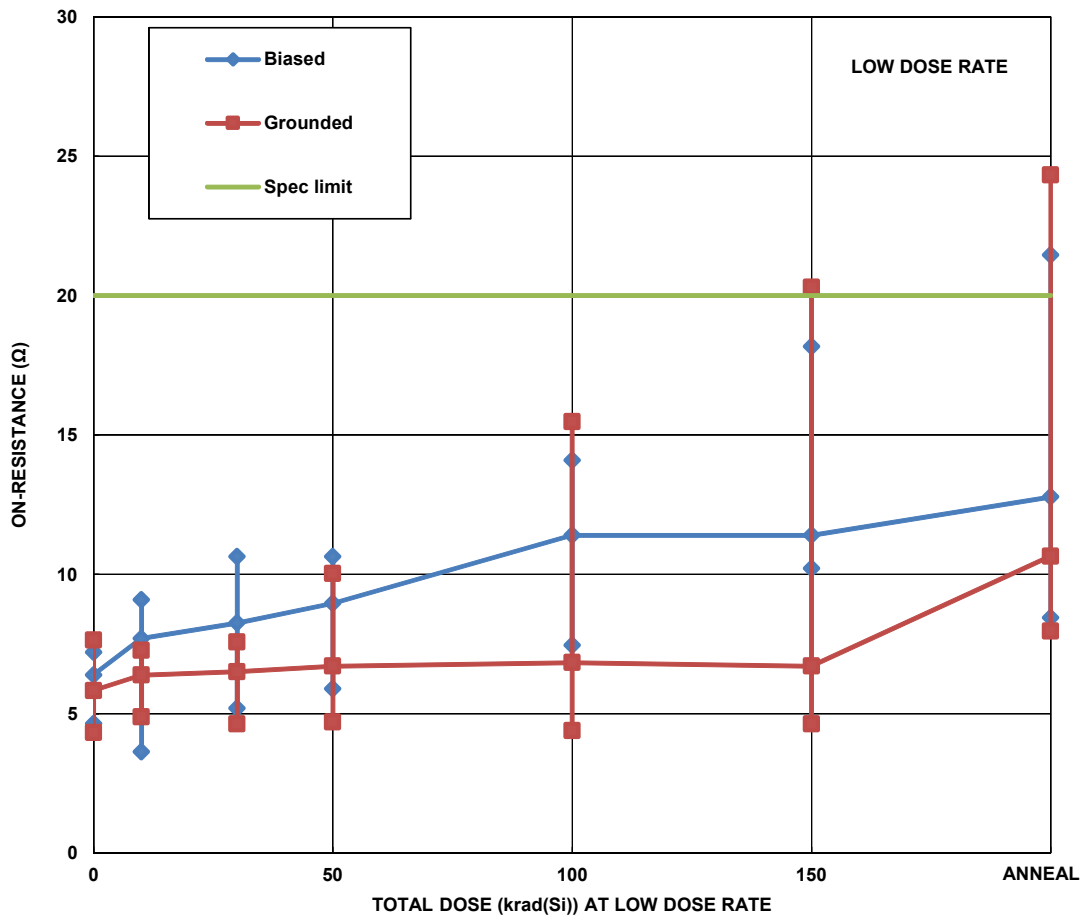

FIGURE 13. ISL71841SEH ON resistance match, average of the medians of all 32 channels and plotting min/max error bars as well, ±15V supplies, -1.0mA output current, +5.0V input voltage, as a function of total dose irradiation at low dose rate for the biased (Figure 2) and unbiased (all pins grounded) cases. The low dose rate was 0.0085rad(Si)/s and the high dose rate was 69.7rad(Si)/s. Irradiations were followed by a 168-hour biased anneal at +100°C. Sample size for the low dose rate cells was 13 and sample size for the high dose rate cells was 4. The post-irradiation SMD limit is 20Ω maximum.

Variables Data Plots (Continued)

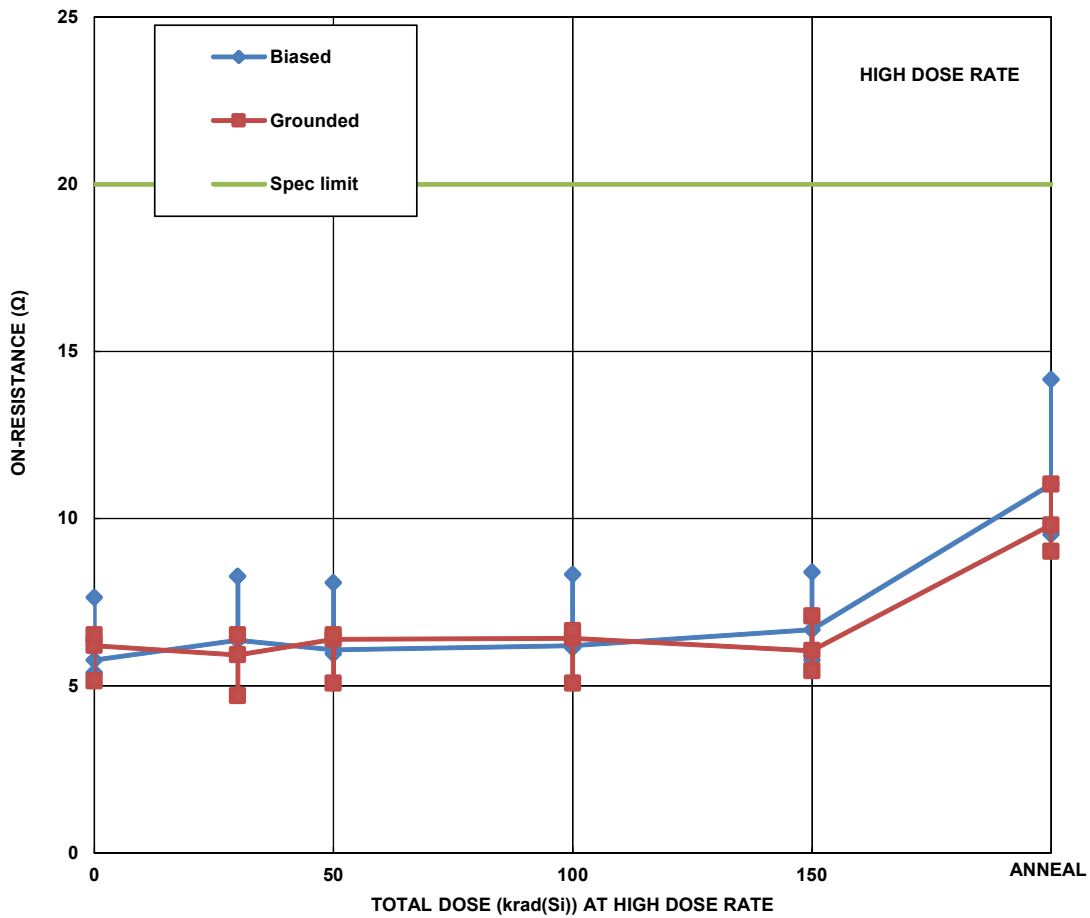

FIGURE 14. ISL71841SEH ON-resistance match, average of the medians of all 32 channels and plotting min/max error bars as well, $\pm 15V$ supplies, $-1.0mA$ output current, $+5.0V$ input voltage, as a function of total dose irradiation at high dose rate for the biased (Figure 2) and unbiased (all pins grounded) cases. The low dose rate was $0.0085rad(Si)/s$ and the high dose rate was $69.7rad(Si)/s$. Irradiations were followed by a 168-hour biased anneal at $+100^{\circ}C$. Sample size for the low dose rate cells was 13 and sample size for the high dose rate cells was 4. The post-irradiation SMD limit is 20Ω maximum.

Variables Data Plots (Continued)

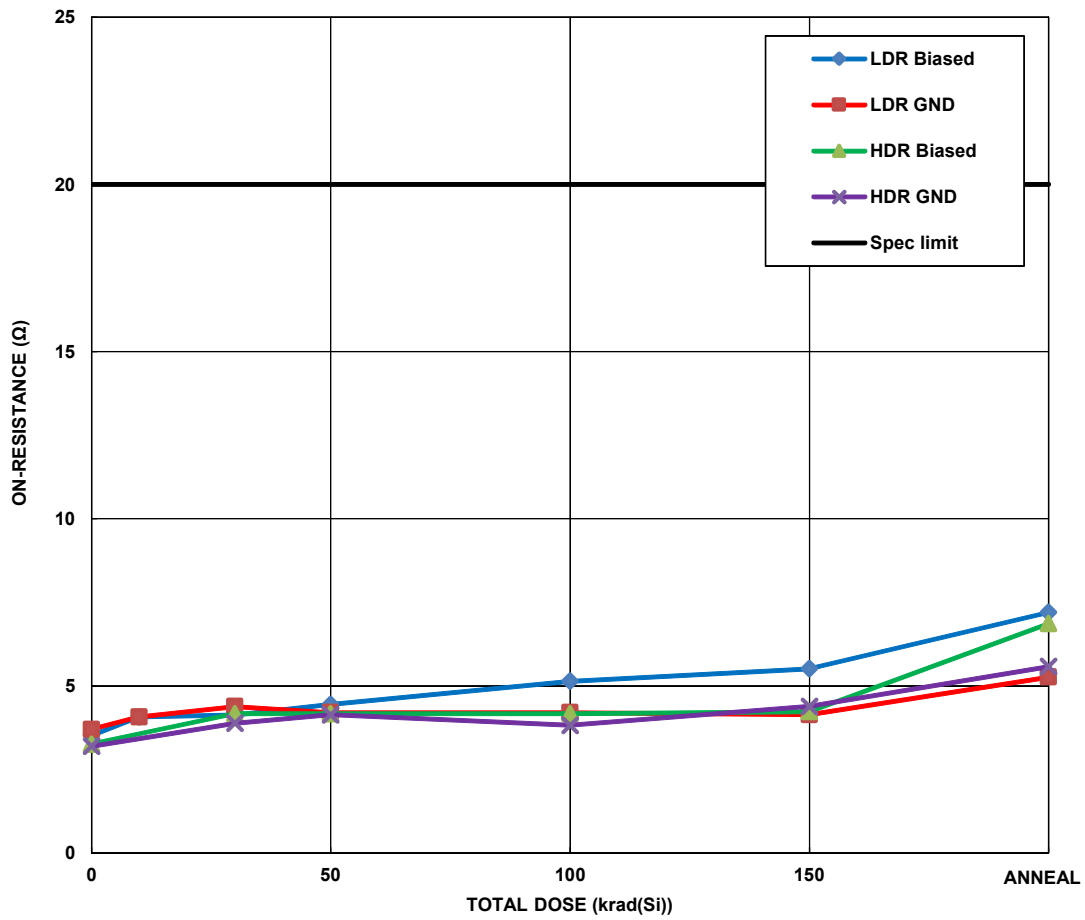

FIGURE 15. ISL71841SEH ON-resistance match, average of the medians of all 32 channels, ±15V supplies, -1.0mA output current, -5.0V input voltage, as a function of total dose irradiation at high and low dose rate for the biased (Figure 2) and unbiased (all pins grounded) cases. The low dose rate was 0.0085rad(Si)/s and the high dose rate was 69.7rad(Si)/s. Irradiations were followed by a 168-hour biased anneal at +100 °C. Sample size for the low dose rate cells was 13 and sample size for the high dose rate cells was 4. The post-irradiation SMD limit is 20Ω maximum.

Variables Data Plots (Continued)

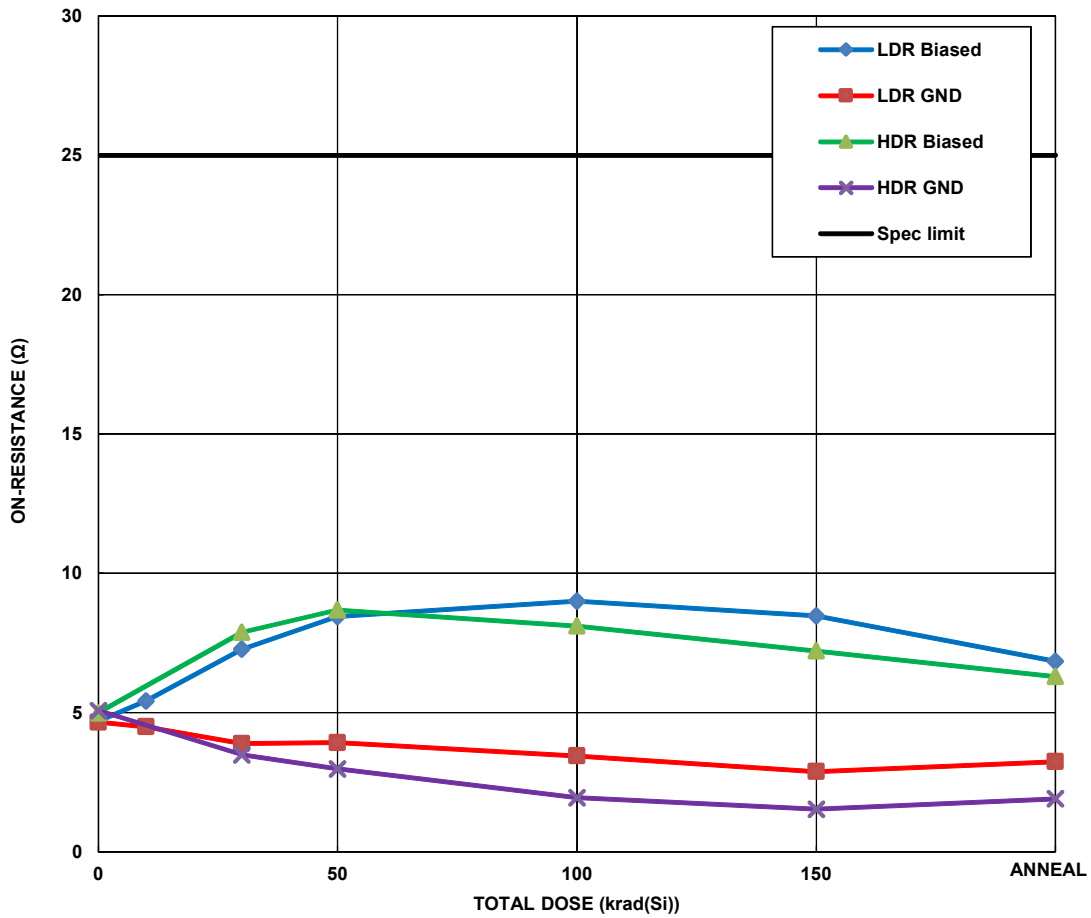

FIGURE 16. ISL71841SEH ON-resistance flatness, average of the medians of all 32 channels, ±15V supplies, -1.0mA output current, -5.0V input voltage, as a function of total dose irradiation at high and low dose rate for the biased (Figure 2) and unbiased (all pins grounded) cases. The low dose rate was 0.0085rad(Si)/s and the high dose rate was 69.7rad(Si)/s. Irradiations were followed by a 168-hour biased anneal at +100 °C. Sample size for the low dose rate cells was 13 and sample size for the high dose rate cells was 4. The post-irradiation SMD limit is 25Ω maximum.

Variables Data Plots (Continued)

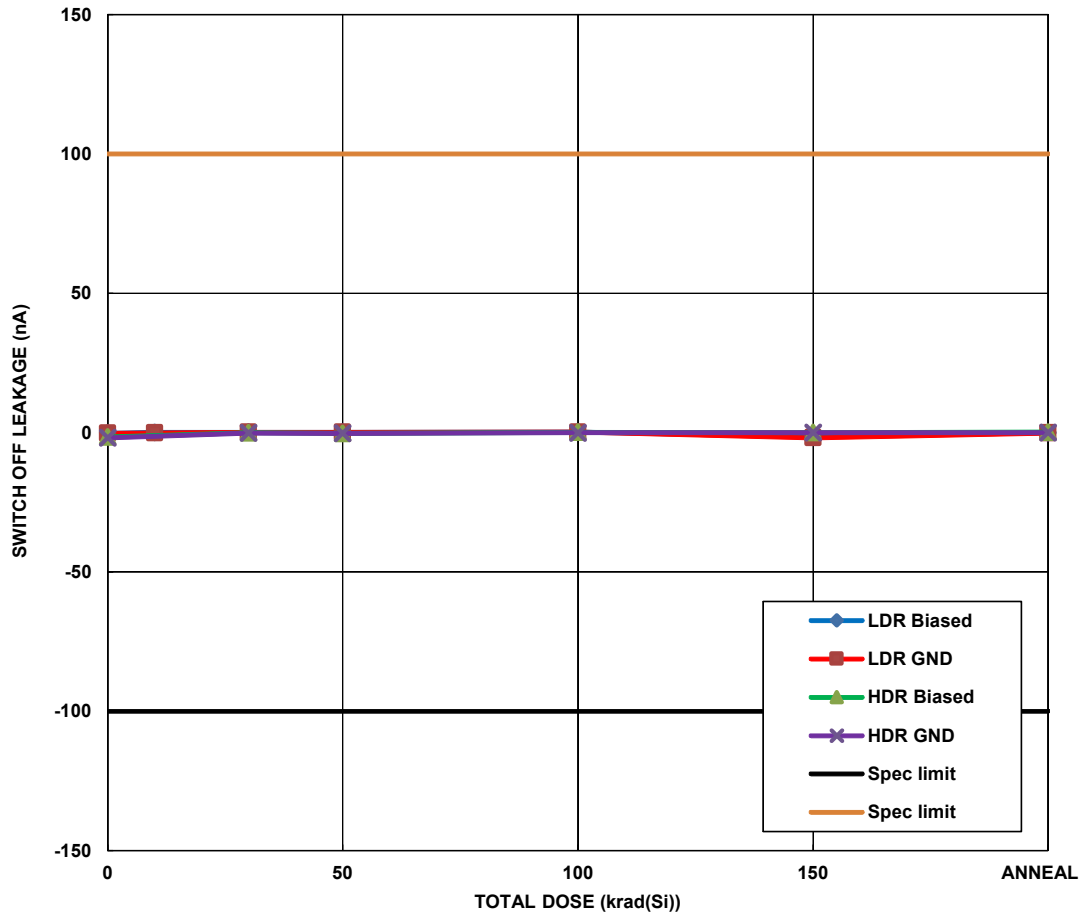

FIGURE 17. ISL71841SEH switch OFF leakage ($I_{S(OFF)}$) into the source of an unselected channel, average of the medians of all 32 channels, supply voltage $\pm 15.0V$, input voltage $+11.5V$, as a function of total dose irradiation at high and low dose rate for the biased (Figure 2) and unbiased (all pins grounded) cases. The low dose rate was 0.0085rad(Si)/s and the high dose rate was 69.7rad(Si)/s . Irradiations were followed by a 168-hour biased anneal at $+100^\circ\text{C}$. Sample size for the low dose rate cells was 13 and sample size for the high dose rate cells was 4. The post-irradiation SMD limits are -100nA to 100nA .

Variables Data Plots (Continued)

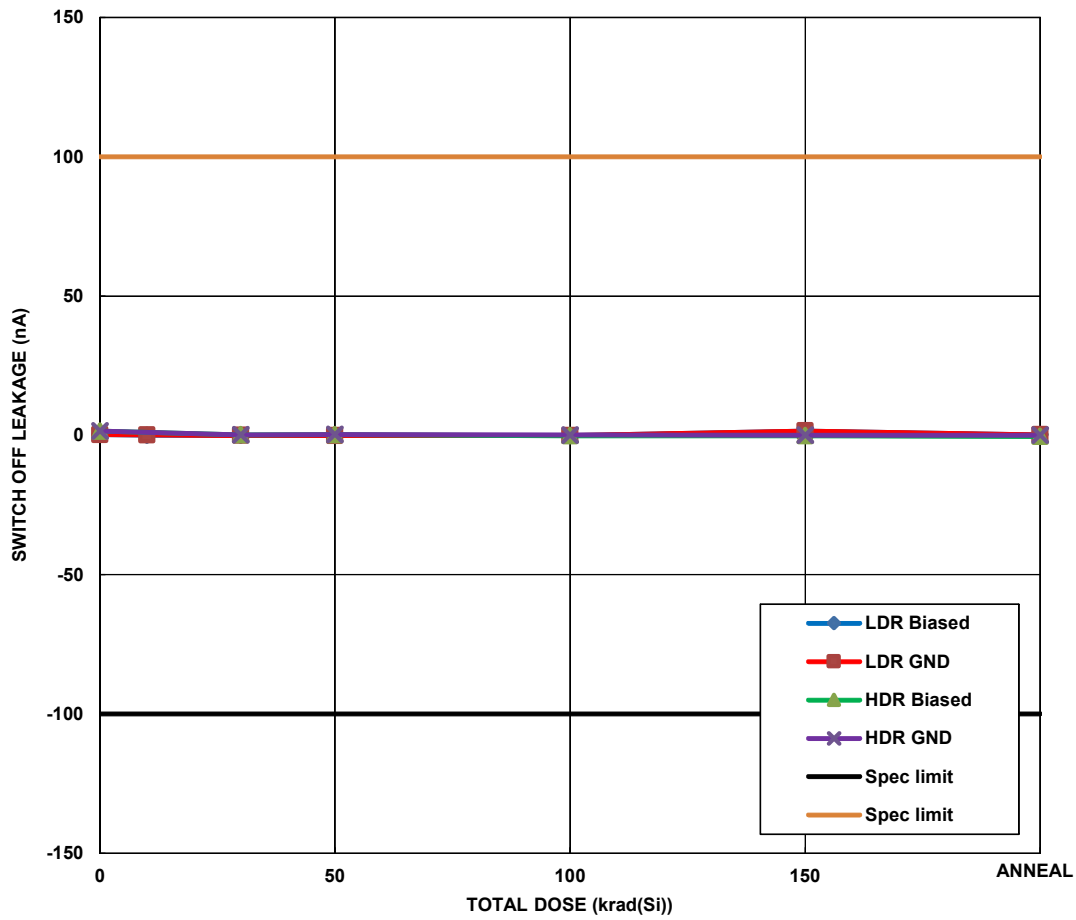

FIGURE 18. ISL71841SEH switch OFF leakage ($I_{S(OFF)}$) into the source of an unselected channel, average of the medians of all 32 channels, supply voltage $\pm 15.0V$, input voltage $-11.5V$ as a function of total dose irradiation at high and low dose rate for the biased (Figure 2) and unbiased (all pins grounded) cases. The low dose rate was 0.0085rad(Si)/s and the high dose rate was 69.7rad(Si)/s . Irradiations were followed by a 168-hour biased anneal at $+100^\circ\text{C}$. Sample size for the low dose rate cells was 13 and sample size for the high dose rate cells was 4. The post-irradiation SMD limits are -100nA to 100nA .

Variables Data Plots (Continued)

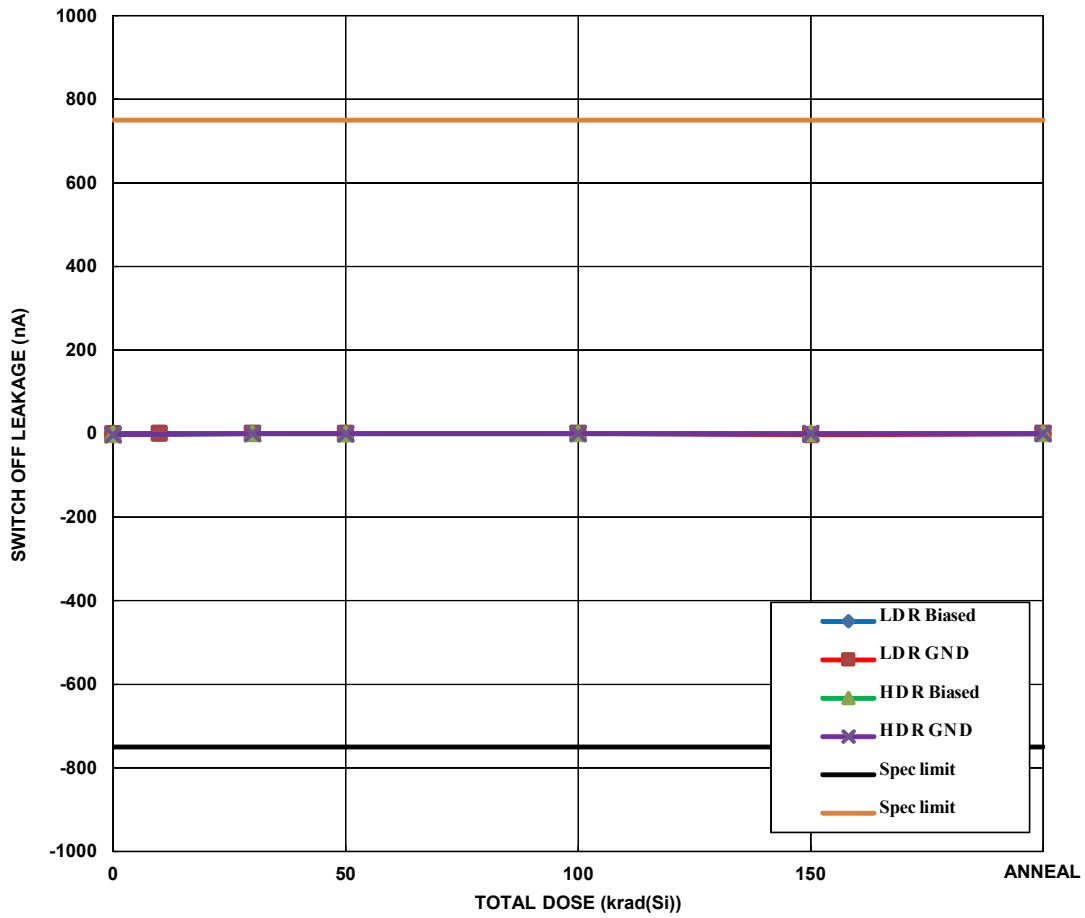

FIGURE 19. ISL71841SEH switch OFF leakage ($I_{S(OFF)}$) into the source of an unselected channel, average of the medians of all 32 channels, supply voltage $\pm 15.0V$, input overvoltage $+35.0V$, as a function of total dose irradiation at high and low dose rate for the biased (Figure 2) and unbiased (all pins grounded) cases. The low dose rate was $0.0085rad(Si)/s$ and the high dose rate was $69.7rad(Si)/s$. Irradiations were followed by a 168-hour biased anneal at $+100^{\circ}C$. Sample size for the low dose rate cells was 13 and sample size for the high dose rate cells was 4. The post-irradiation SMD limits are $-750nA$ to $+750nA$.

Variables Data Plots (Continued)

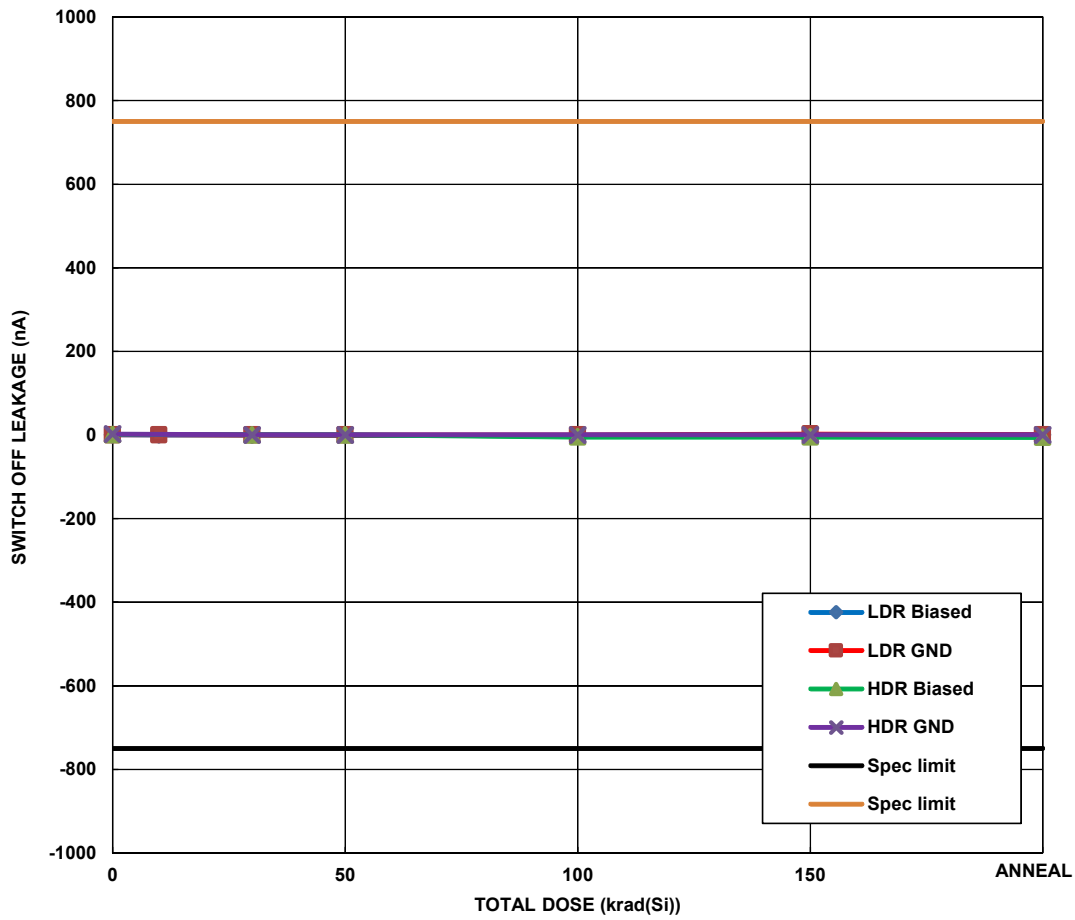

FIGURE 20. ISL71841SEH switch OFF leakage ($I_{S(OFF)}$) into the source of an unselected channel, average of the medians of all 32 channels, supply voltage $\pm 15.0V$, input overvoltage $-35.0V$, as a function of total dose irradiation at high and low dose rate for the biased (Figure 2) and unbiased (all pins grounded) cases. The low dose rate was $0.0085rad(Si)/s$ and the high dose rate was $69.7rad(Si)/s$. Irradiations were followed by a 168-hour biased anneal at $+100^{\circ}C$. Sample size for the low dose rate cells was 13 and sample size for the high dose rate cells was 4. The post-irradiation SMD limits are $-750nA$ to $+750nA$.

Variables Data Plots (Continued)

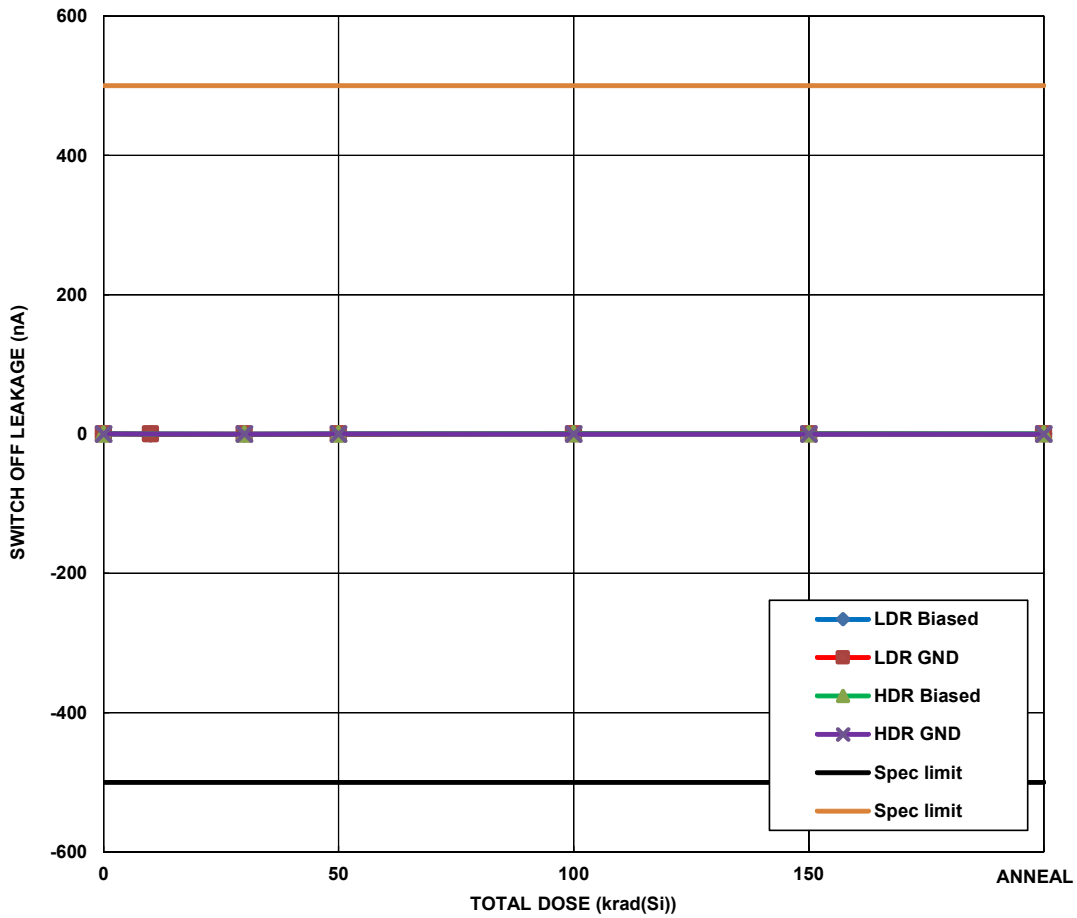

FIGURE 21. ISL71841SEH switch OFF leakage ($I_{D(OFF)}$) into the drain of an unselected channel, average of the medians of all 32 channels, supply voltage $\pm 15.0V$, input overvoltage $+35.0V$, as a function of total dose irradiation at high and low dose rate for the biased (Figure 2) and unbiased (all pins grounded) cases. The low dose rate was 0.0085rad(Si)/s and the high dose rate was 69.7rad(Si)/s . Irradiations were followed by a 168-hour biased anneal at $+100^\circ\text{C}$. Sample size for the low dose rate cells was 13 and sample size for the high dose rate cells was 4. The post-irradiation SMD limits are -500nA to $+500\text{nA}$.

Variables Data Plots (Continued)

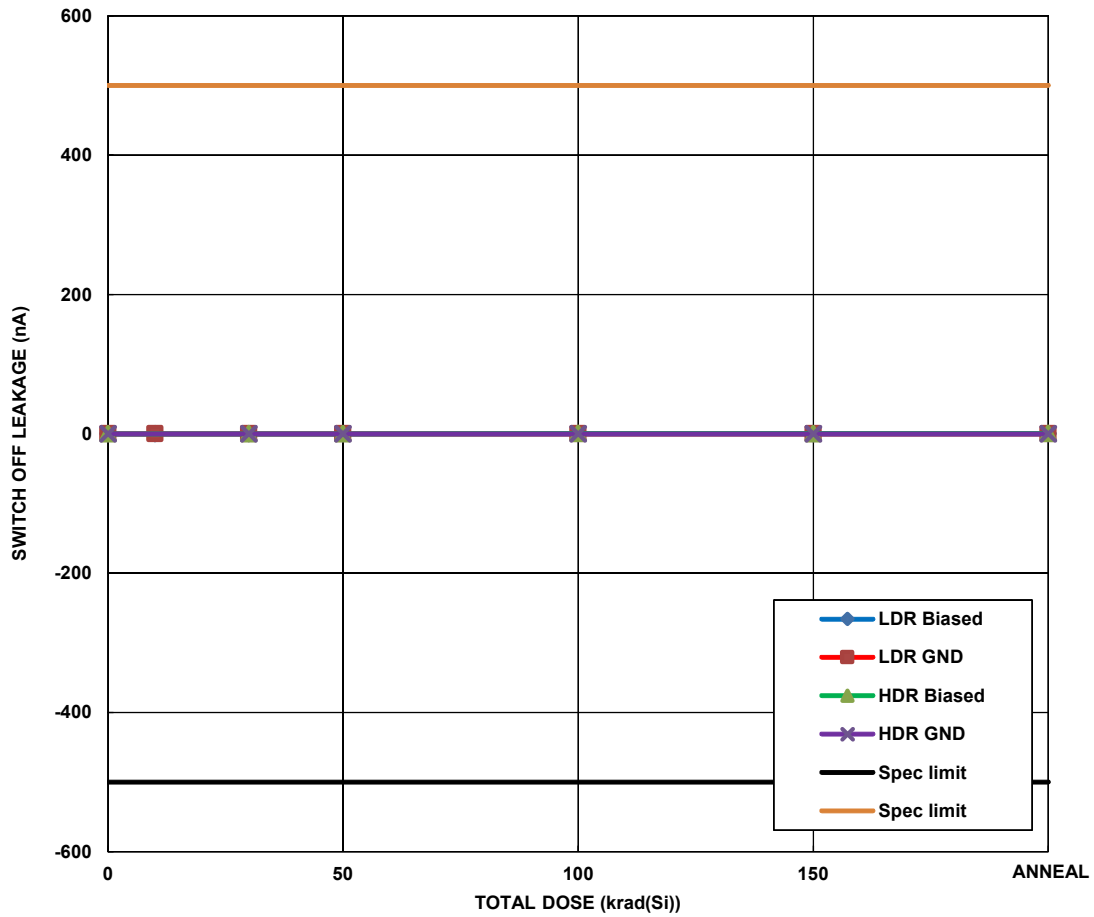

FIGURE 22. ISL71841SEH switch OFF leakage ($I_{D(OFF)}$) into the drain of an unselected channel, average of the medians of all 32 channels, supply voltage $\pm 15.0V$, input overvoltage $-35.0V$, as a function of total dose irradiation at high and low dose rate for the biased (Figure 2) and unbiased (all pins grounded) cases. The low dose rate was 0.0085rad(Si)/s and the high dose rate was 69.7rad(Si)/s . Irradiations were followed by a 168-hour biased anneal at $+100^\circ\text{C}$. Sample size for the low dose rate cells was 13 and sample size for the high dose rate cells was 4. The post-irradiation SMD limits are -500nA to $+500\text{nA}$.

Variables Data Plots (Continued)

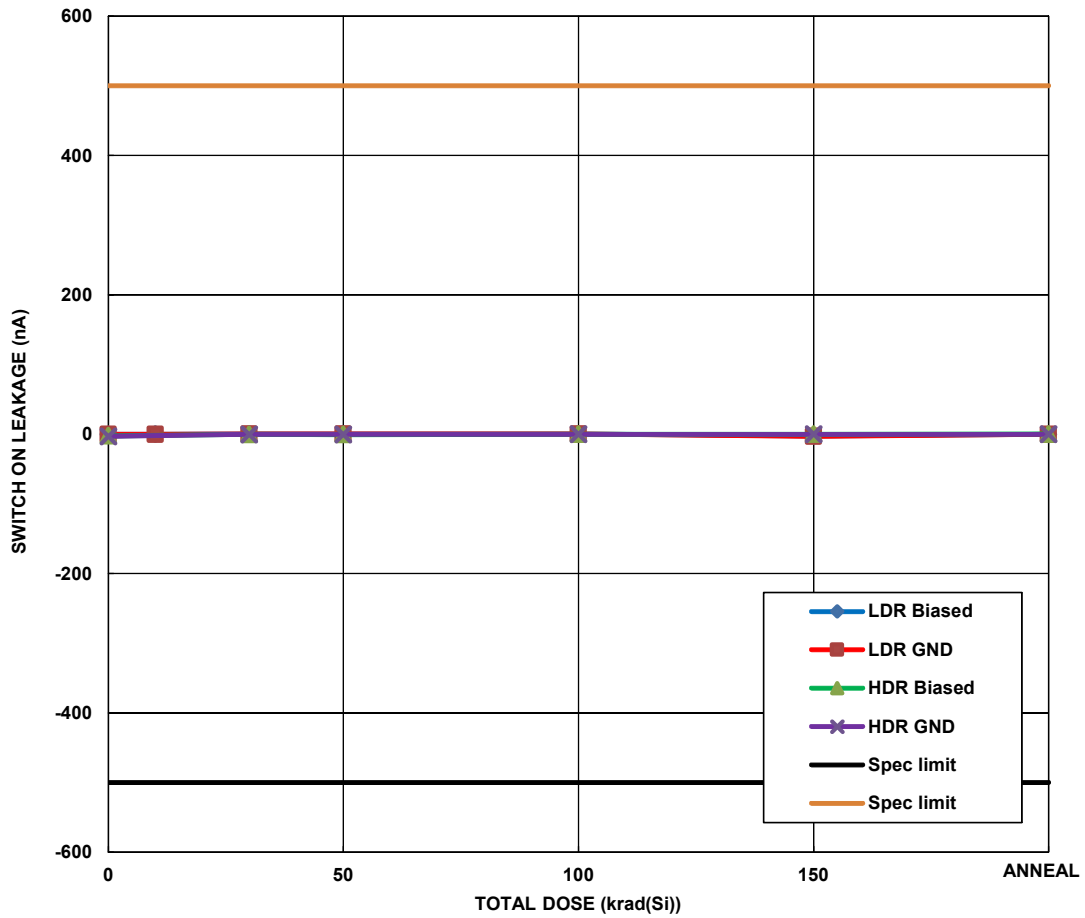

FIGURE 23. ISL71841SEH switch ON leakage ($I_{S(ON)}$) into the source of a selected channel, average of the medians of all 32 channels, supply voltage $\pm 15.0V$, input overvoltage $+35.0V$, as a function of total dose irradiation at high and low dose rate for the biased (Figure 2) and unbiased (all pins grounded) cases. The low dose rate was 0.0085rad(Si)/s and the high dose rate was 69.7rad(Si)/s . Irradiations were followed by a 168-hour biased anneal at $+100^\circ\text{C}$. Sample size for the low dose rate cells was 13 and sample size for the high dose rate cells was 4. The post-irradiation SMD limits are -500nA to $+500\text{nA}$.

Variables Data Plots (Continued)

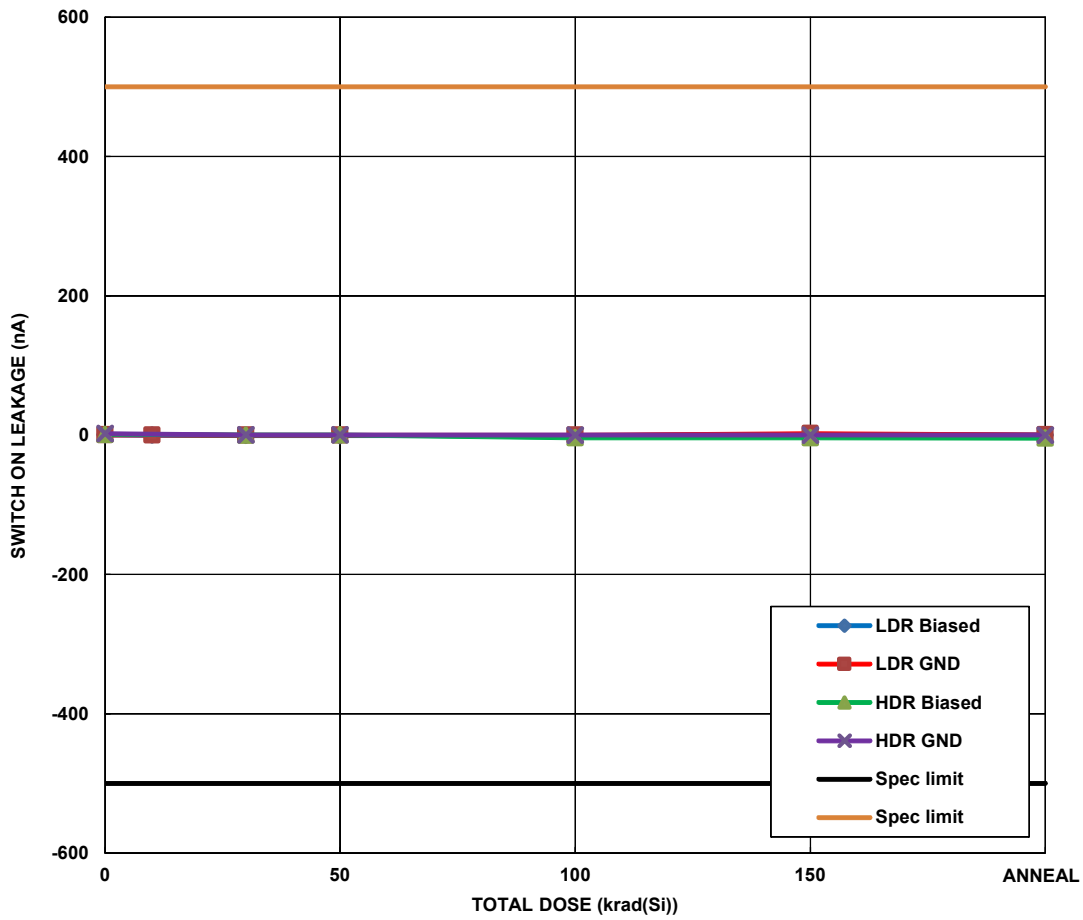

FIGURE 24. ISL71841SEH switch ON leakage ($I_{S(ON)}$) into the source of a selected channel, average of the medians of all 32 channels, supply voltage $\pm 15.0V$, input overvoltage $-35.0V$, as a function of total dose irradiation at high and low dose rate for the biased (Figure 2) and unbiased (all pins grounded) cases. The low dose rate was 0.0085rad(Si)/s and the high dose rate was 69.7rad(Si)/s . Irradiations were followed by a 168-hour biased anneal at $+100^\circ\text{C}$. Sample size for the low dose rate cells was 13 and sample size for the high dose rate cells was 4. The post-irradiation SMD limits are -500nA to $+500\text{nA}$.

Variables Data Plots (Continued)

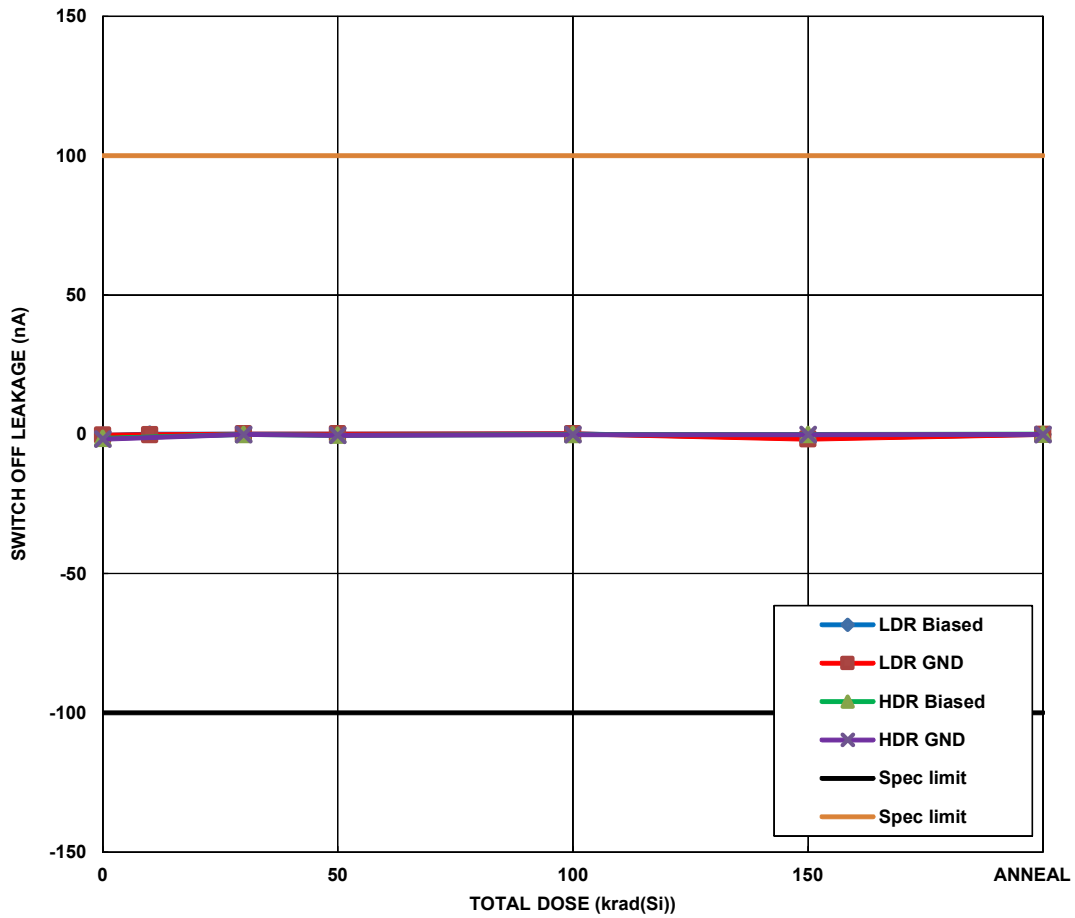

FIGURE 25. ISL71841SEH switch OFF leakage ($I_{S(OFF)}$) into the source of an unselected channel, average of the medians of all 32 channels, with supply, address and ENABLE pins open, input voltage +25.0V, as a function of total dose irradiation at high and low dose rate for the biased (Figure 2) and unbiased (all pins grounded) cases. The low dose rate was 0.0085rad(Si)/s and the high dose rate was 69.7rad(Si)/s. Irradiations were followed by a 168-hour biased anneal at +100 °C. Sample size for the low dose rate cells was 13 and sample size for the high dose rate cells was 4. The post-irradiation SMD limits are -100nA to +100nA.

Variables Data Plots (Continued)

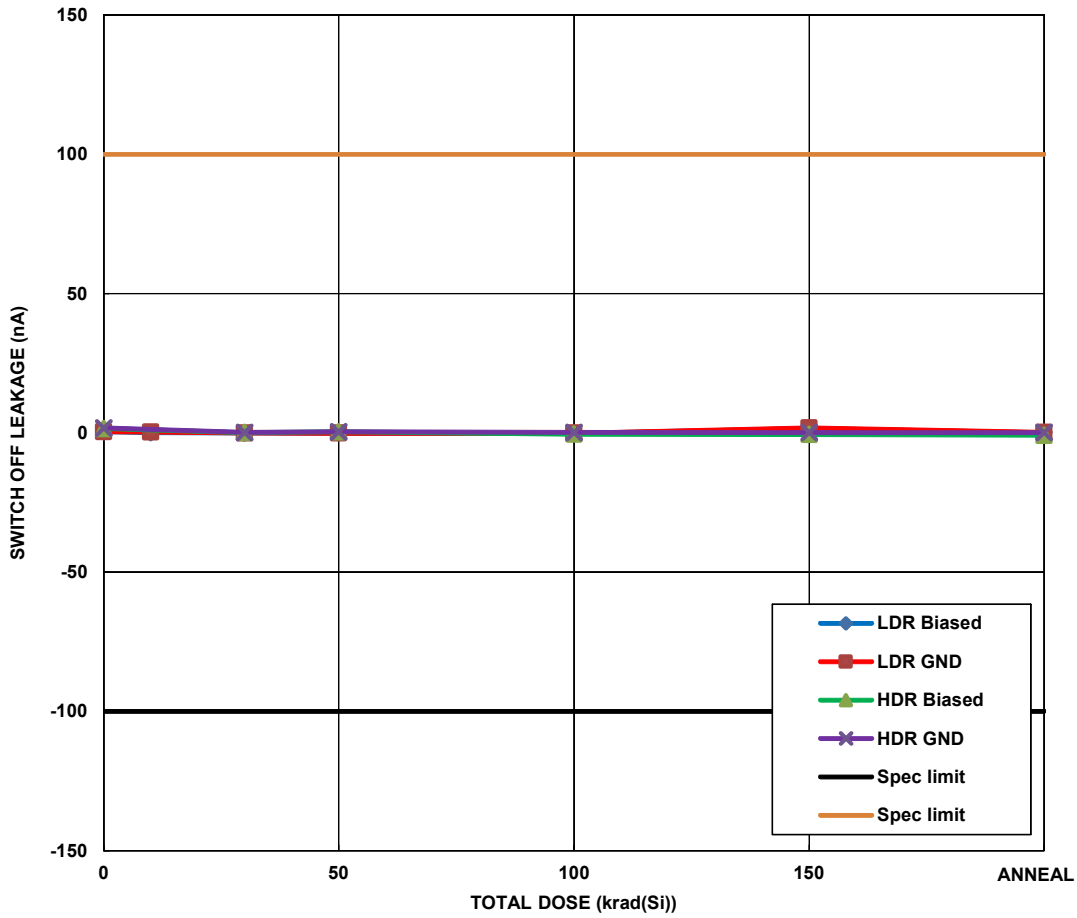

FIGURE 26. ISL71841SEH switch OFF leakage ($I_{S(OFF)}$) into the source of an unselected channel, average of the medians of all 32 channels, with supply, address and ENABLE pins open, input voltage -25.0V, as a function of total dose irradiation at high and low dose rate for the biased (Figure 2) and unbiased (all pins grounded) cases. The low dose rate was 0.0085rad(Si)/s and the high dose rate was 69.7rad(Si)/s. Irradiations were followed by a 168-hour biased anneal at +100 °C. Sample size for the low dose rate cells was 13 and sample size for the high dose rate cells was 4. The post-irradiation SMD limits are -100nA to +100nA.

Variables Data Plots (Continued)

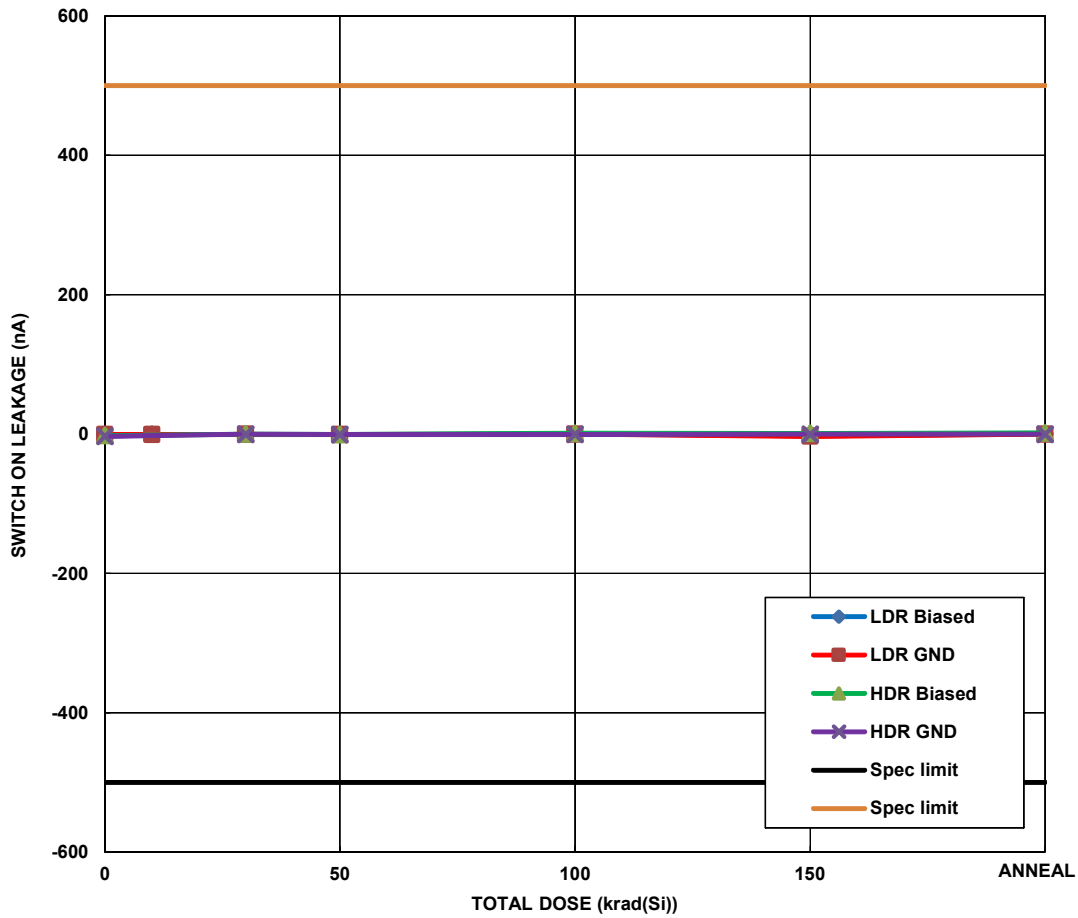

FIGURE 27. ISL71841SEH switch ON leakage ($I_{D(ON)}$) into the source and drain of a selected channel, average of the medians of all 32 channels, supply voltage $\pm 15.0V$, input and output voltage $11.6V$, as a function of total dose irradiation at high and low dose rate for the biased (Figure 2) and unbiased (all pins grounded) cases. The low dose rate was $0.0085rad(Si)/s$ and the high dose rate was $69.7rad(Si)/s$. Irradiations were followed by a 168-hour biased anneal at $+100^{\circ}C$. Sample size for the low dose rate cells was 13 and sample size for the high dose rate cells was 4. The post-irradiation SMD limits are $-500nA$ to $+500nA$.

Variables Data Plots (Continued)

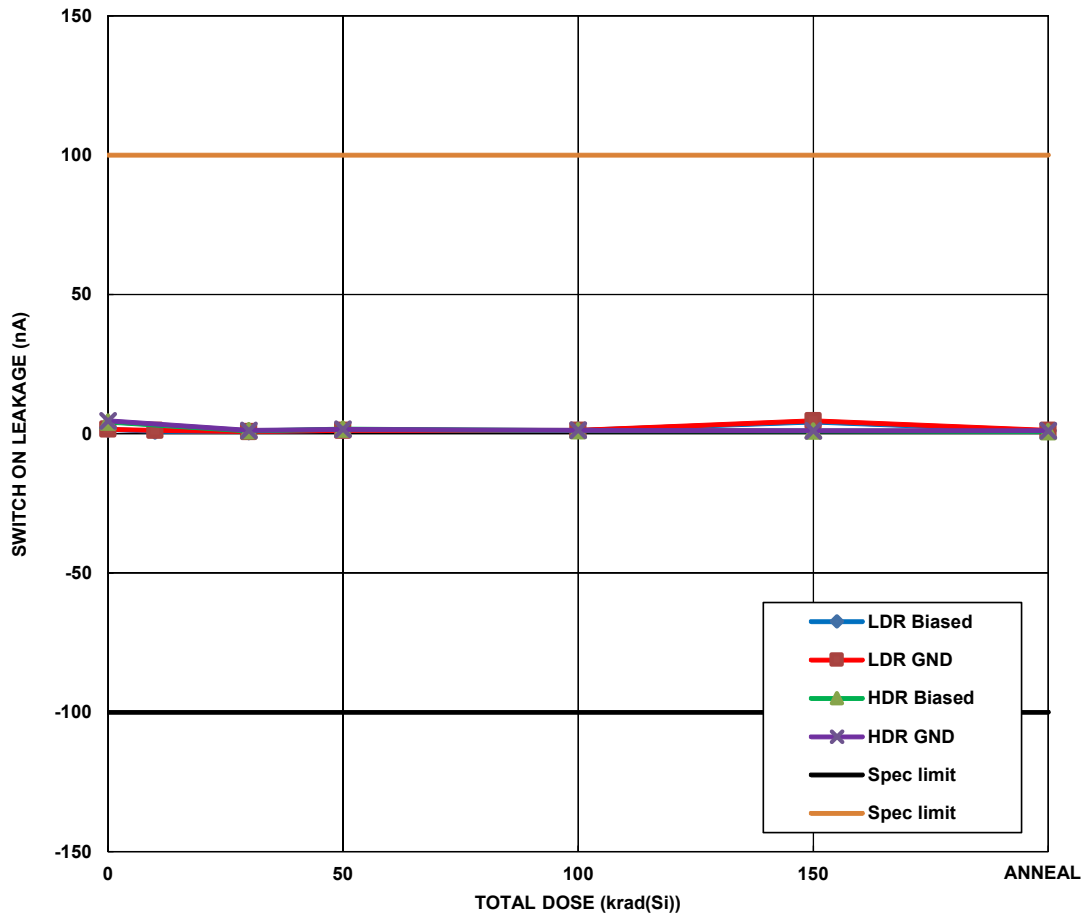

FIGURE 28. ISL71841SEH switch ON leakage ($I_{D(ON)}$) into the source and drain of a selected channel, average of the medians of all 32 channels, supply voltage $\pm 15.0V$, input and output voltage $-11.6V$, as a function of total dose irradiation at high and low dose rate for the biased (Figure 2) and unbiased (all pins grounded) cases. The low dose rate was 0.0085rad(Si)/s and the high dose rate was 69.7rad(Si)/s . Irradiations were followed by a 168-hour biased anneal at $+100^\circ\text{C}$. Sample size for the low dose rate cells was 13 and sample size for the high dose rate cells was 4. The post-irradiation SMD limits are -100nA to $+100\text{nA}$.

Variables Data Plots (Continued)

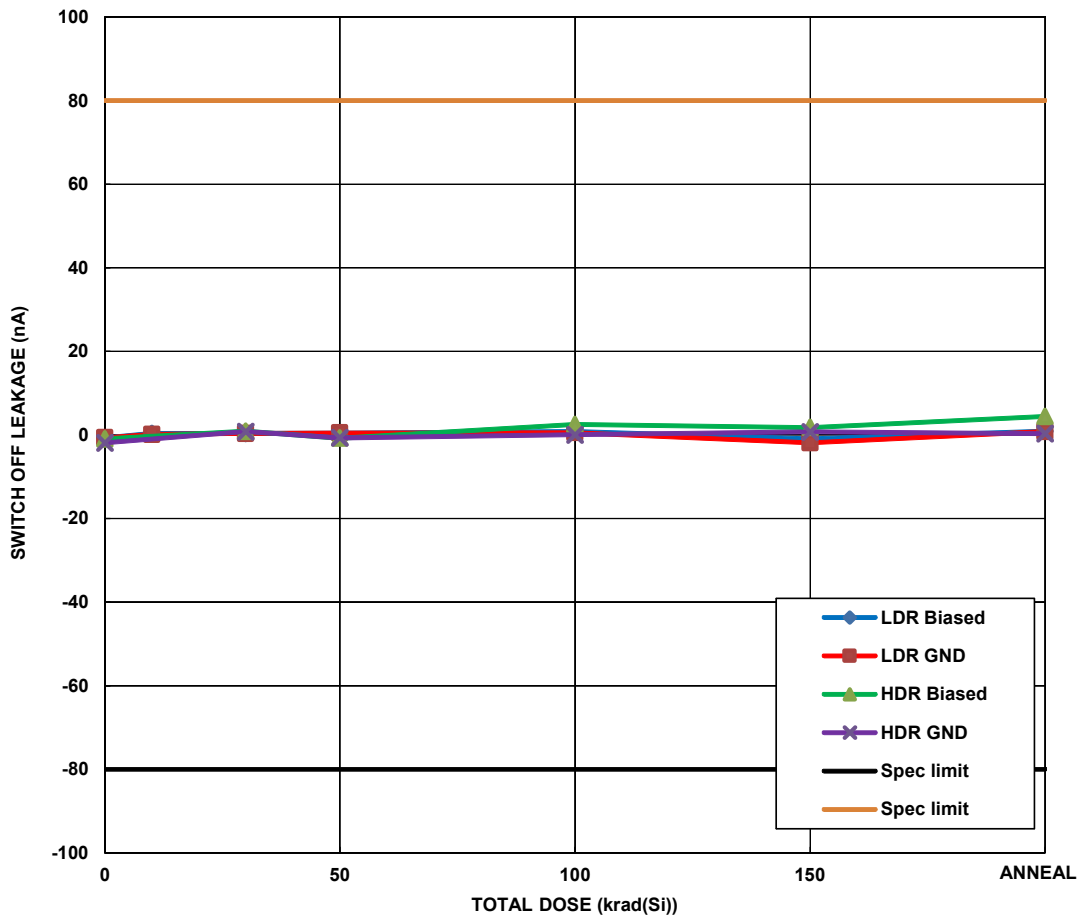

FIGURE 29. ISL71841SEH switch OFF leakage ($I_{D(OFF)}$) into the drain with the part disabled, average of the medians of all 32 channels, supply voltage $\pm 15.0V$, output voltage $+10.0V$, input voltage $-10.0V$, as a function of total dose irradiation at high and low dose rate for the biased (Figure 2) and unbiased (all pins grounded) cases. The low dose rate was $0.0085rad(Si)/s$ and the high dose rate was $69.7rad(Si)/s$. Irradiations were followed by a 168-hour biased anneal at $+100^{\circ}C$. Sample size for the low dose rate cells was 13 and sample size for the high dose rate cells was 4. The post-irradiation SMD limits are $-80nA$ to $+80nA$.

Variables Data Plots (Continued)

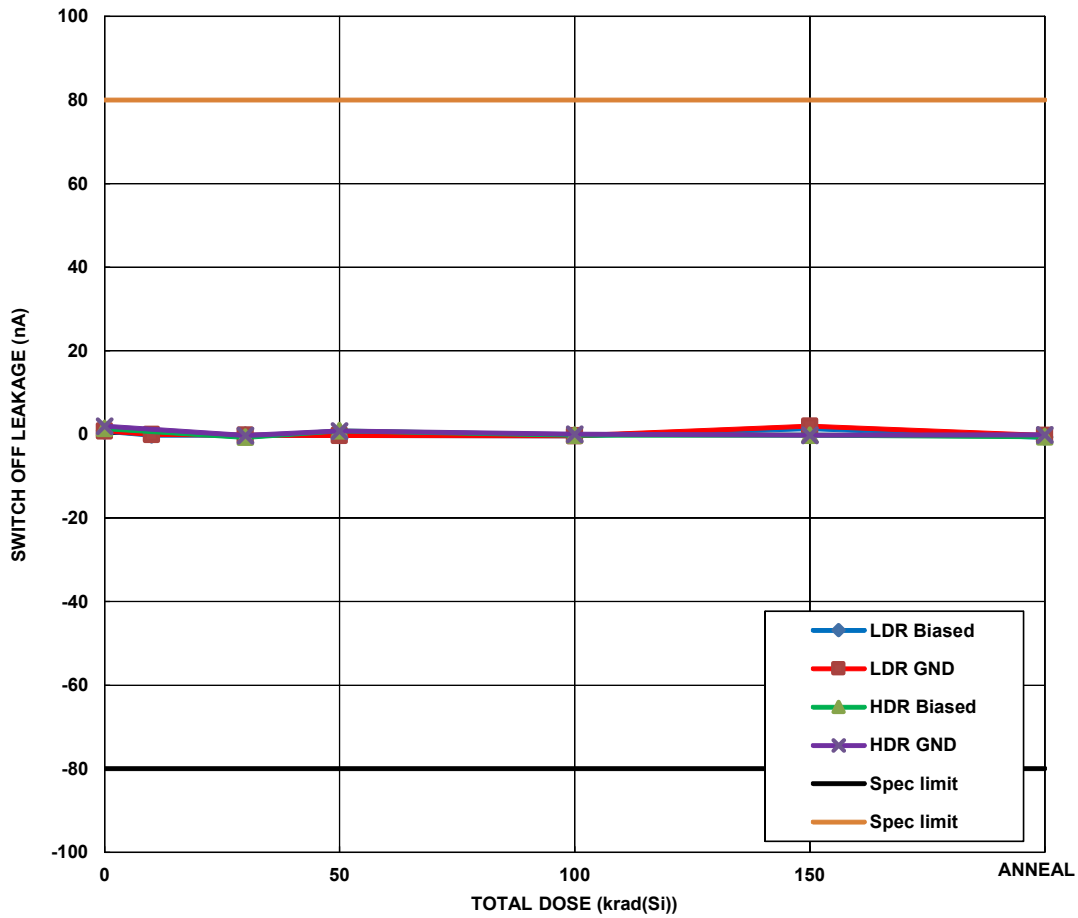

FIGURE 30. ISL71841SEH switch OFF leakage ($I_{D(OFF)}$) into the drain with the part disabled, average of the medians of all 32 channels, supply voltage $\pm 15.0V$, output voltage $-10.0V$, input voltage $+10.0V$, as a function of total dose irradiation at high and low dose rate for the biased (Figure 2) and unbiased (all pins grounded) cases. The low dose rate was 0.0085rad(Si)/s and the high dose rate was 69.7rad(Si)/s . Irradiations were followed by a 168-hour biased anneal at $+100^\circ\text{C}$. Sample size for the low dose rate cells was 13 and sample size for the high dose rate cells was 4. The post-irradiation SMD limits are -80nA to $+80\text{nA}$.

Variables Data Plots (Continued)

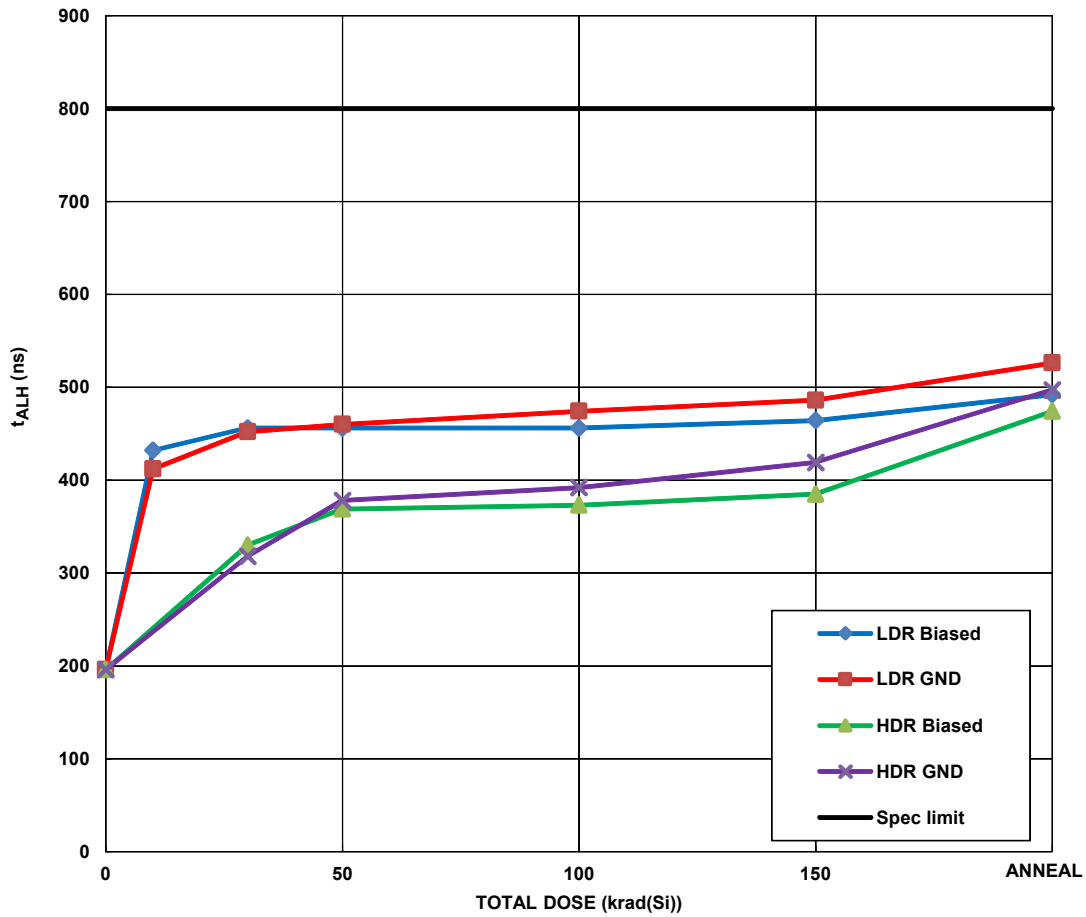

FIGURE 31. ISL71841SEH address to output access time, LOW to HIGH, supply voltage $\pm 15.0V$, as a function of total dose irradiation at high and low dose rate for the biased (Figure 2) and unbiased (all pins grounded) cases. The low dose rate was 0.0085rad(Si)/s and the high dose rate was 69.7rad(Si)/s . Irradiations were followed by a 168-hour biased anneal at $+100^\circ\text{C}$. Sample size for the low dose rate cells was 13 and sample size for the high dose rate cells was 4. The post-irradiation SMD limit is 800ns maximum.

Variables Data Plots (Continued)

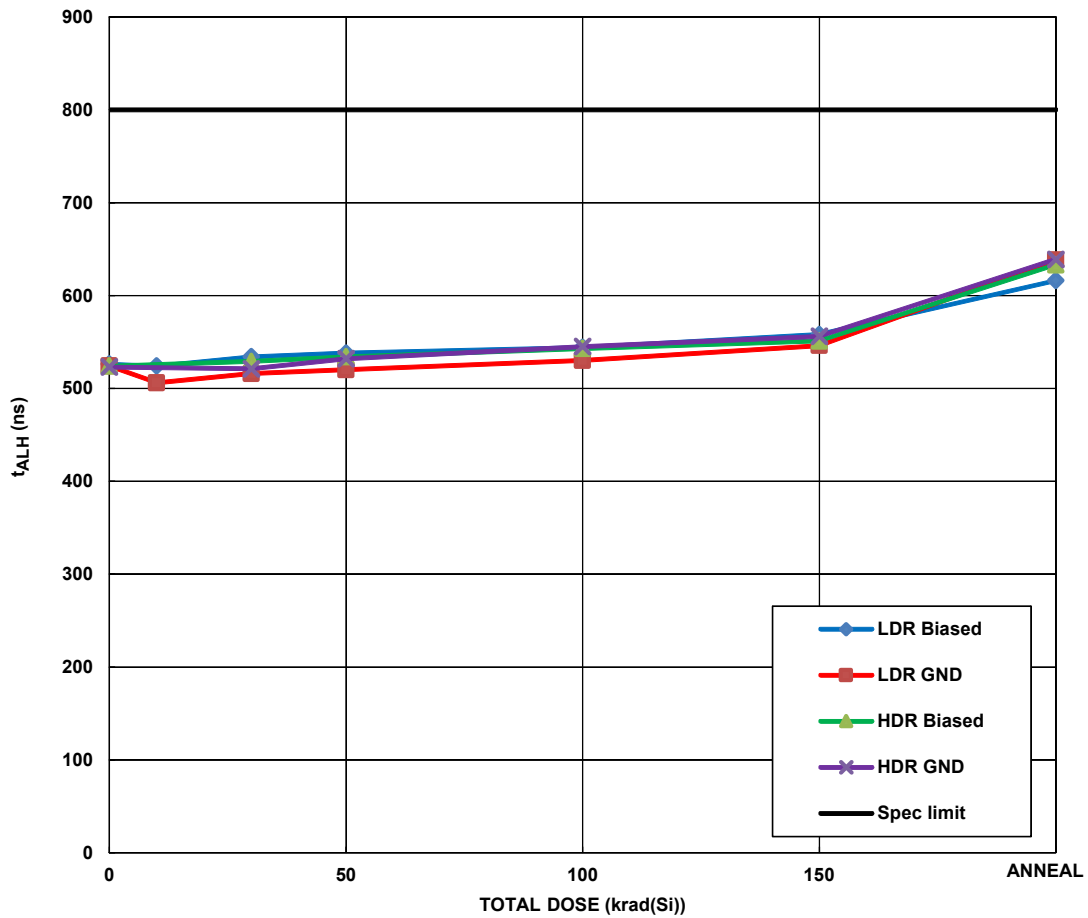

FIGURE 32. ISL71841SEH address to output access time, HIGH to LOW, supply voltage $\pm 15.0V$, as a function of total dose irradiation at high and low dose rate for the biased (Figure 2) and unbiased (all pins grounded) cases. The low dose rate was $0.0085\text{rad(Si)}/\text{s}$ and the high dose rate was $69.7\text{rad(Si)}/\text{s}$. Irradiations were followed by a 168-hour biased anneal at $+100^\circ\text{C}$. Sample size for the low dose rate cells was 13 and sample size for the high dose rate cells was 4. The post-irradiation SMD limit is 800ns maximum.

Variables Data Plots (Continued)

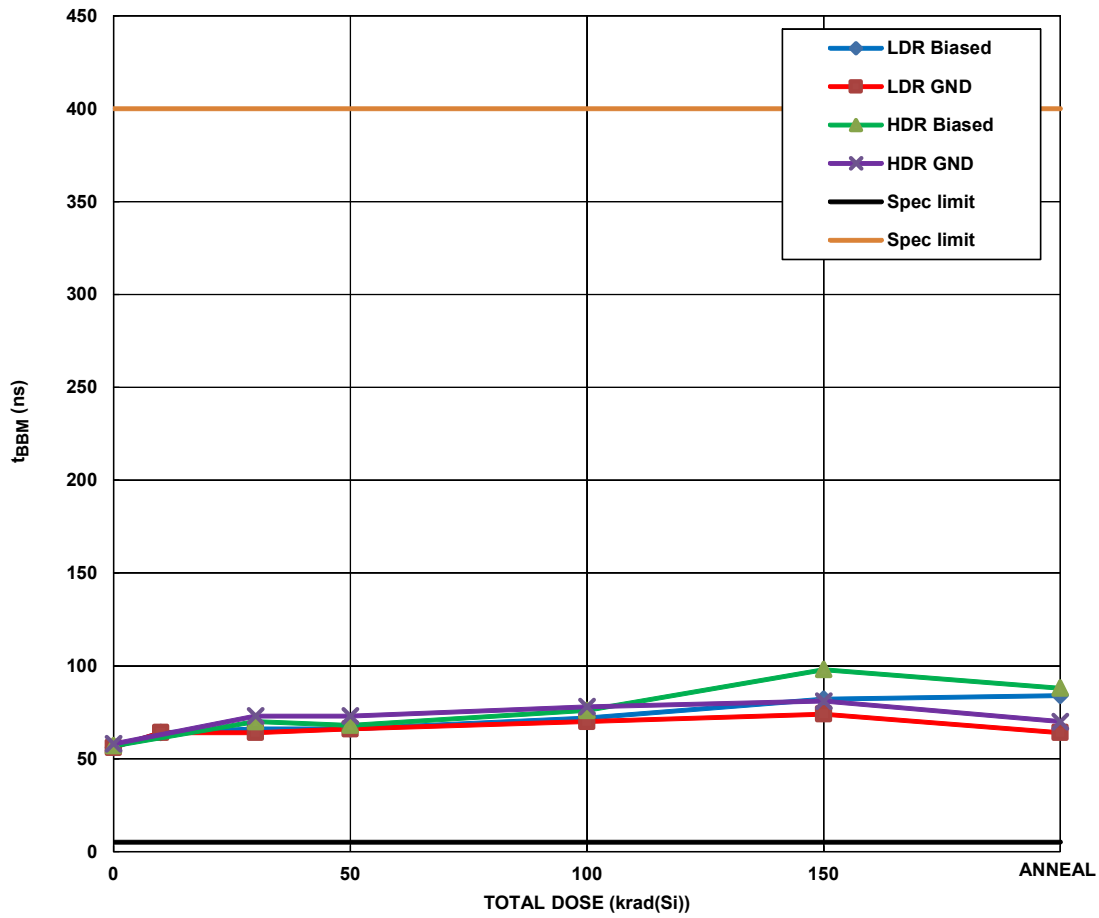

FIGURE 33. ISL71841SEH break-before-make time delay, supply voltage $\pm 15.0V$, as a function of total dose irradiation at high and low dose rate for the biased (Figure 2) and unbiased (all pins grounded) cases. The low dose rate was $0.0085\text{rad(Si)}/\text{s}$ and the high dose rate was $69.7\text{rad(Si)}/\text{s}$. Irradiations were followed by a 168-hour biased anneal at $+100^\circ\text{C}$. Sample size for the low dose rate cells was 13 and sample size for the high dose rate cells was 4. The post-irradiation SMD limits are 5ns to 400ns.

Variables Data Plots (Continued)

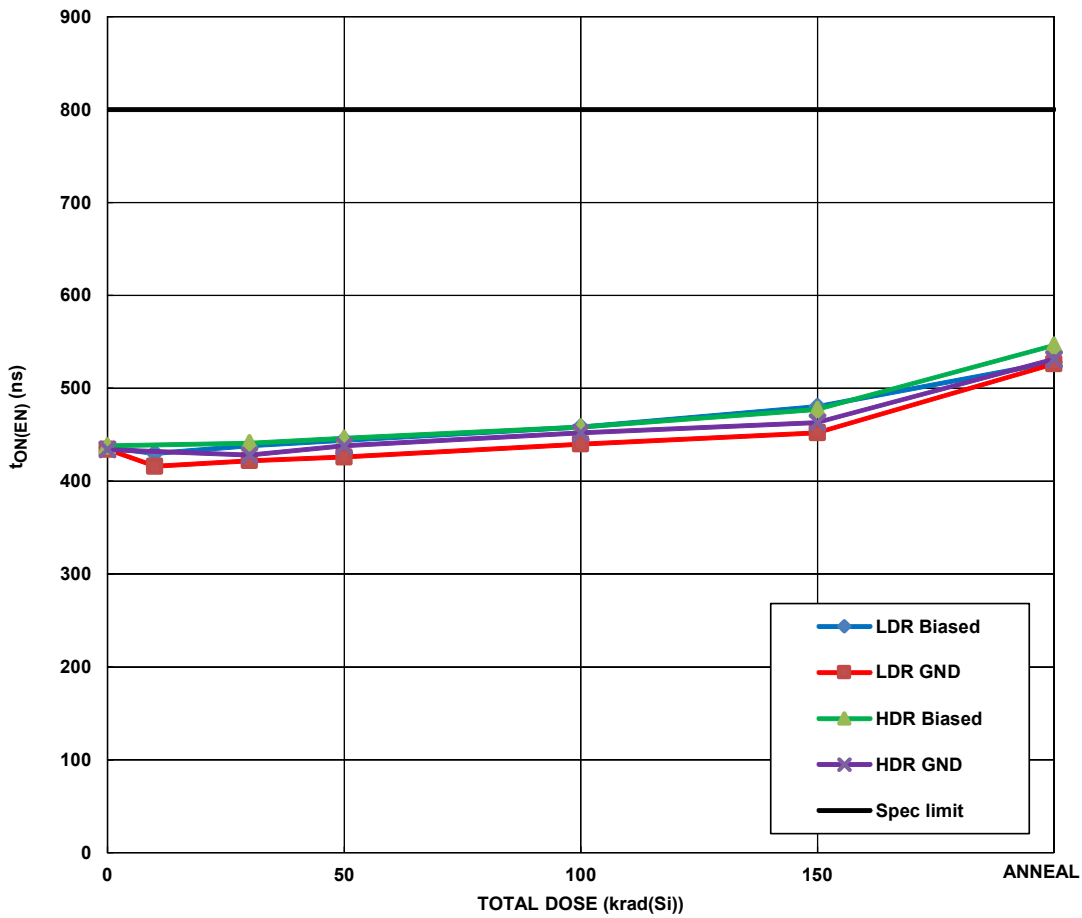

FIGURE 34. ISL71841SEH enable to output ON delay, supply voltage $\pm 15.0V$, as a function of total dose irradiation at high and low dose rate for the biased (Figure 2) and unbiased (all pins grounded) cases. The low dose rate was $0.0085\text{rad(Si)}/\text{s}$ and the high dose rate was $69.7\text{rad(Si)}/\text{s}$. Irradiations were followed by a 168-hour biased anneal at $+100^\circ\text{C}$. Sample size for the low dose rate cells was 13 and sample size for the high dose rate cells was 4. The post-irradiation SMD limit is 800ns maximum.

Variables Data Plots (Continued)

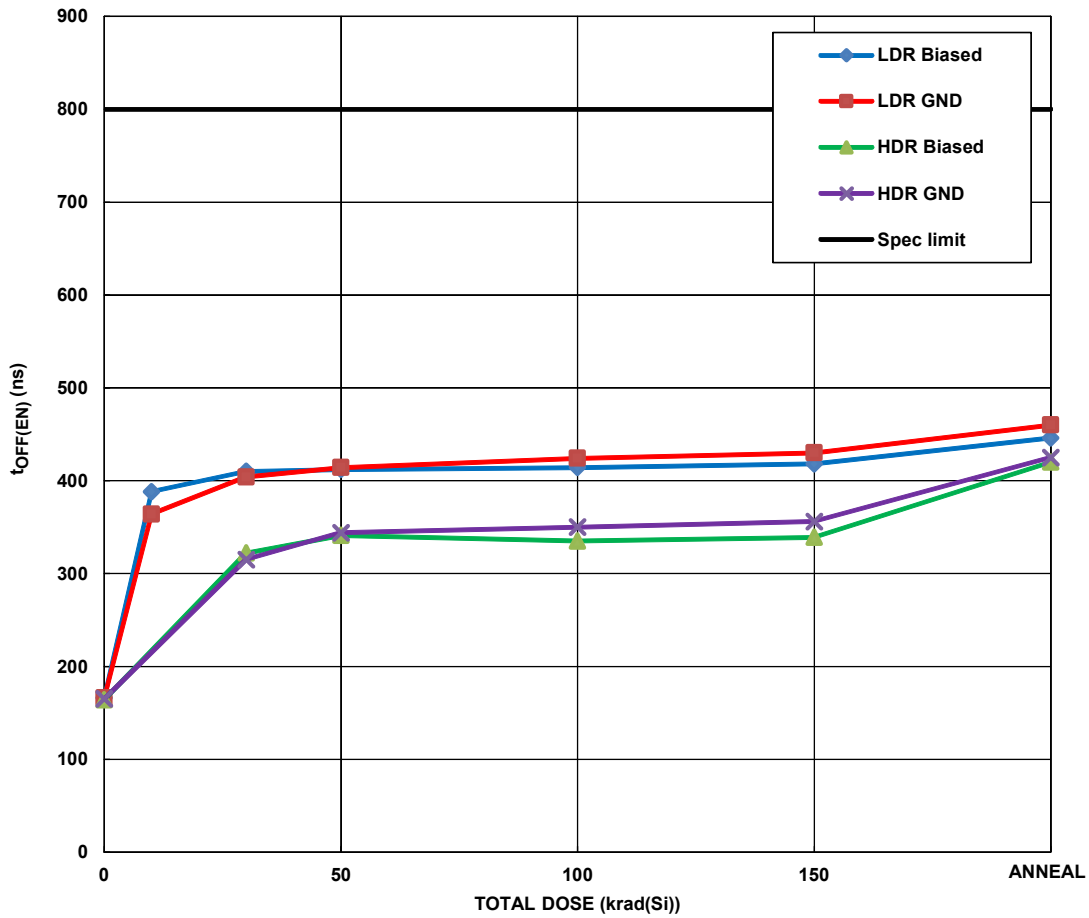

FIGURE 35. ISL71841SEH enable to output OFF delay, supply voltage $\pm 15.0V$, as a function of total dose irradiation at high and low dose rate for the biased (Figure 2) and unbiased (all pins grounded) cases. The low dose rate was 0.0085rad(Si)/s and the high dose rate was 69.7rad(Si)/s . Irradiations were followed by a 168-hour biased anneal at $+100^\circ\text{C}$. Sample size for the low dose rate cells was 13 and sample size for the high dose rate cells was 4. The post-irradiation SMD limit is 800ns maximum.

Variables Data Plots (Continued)

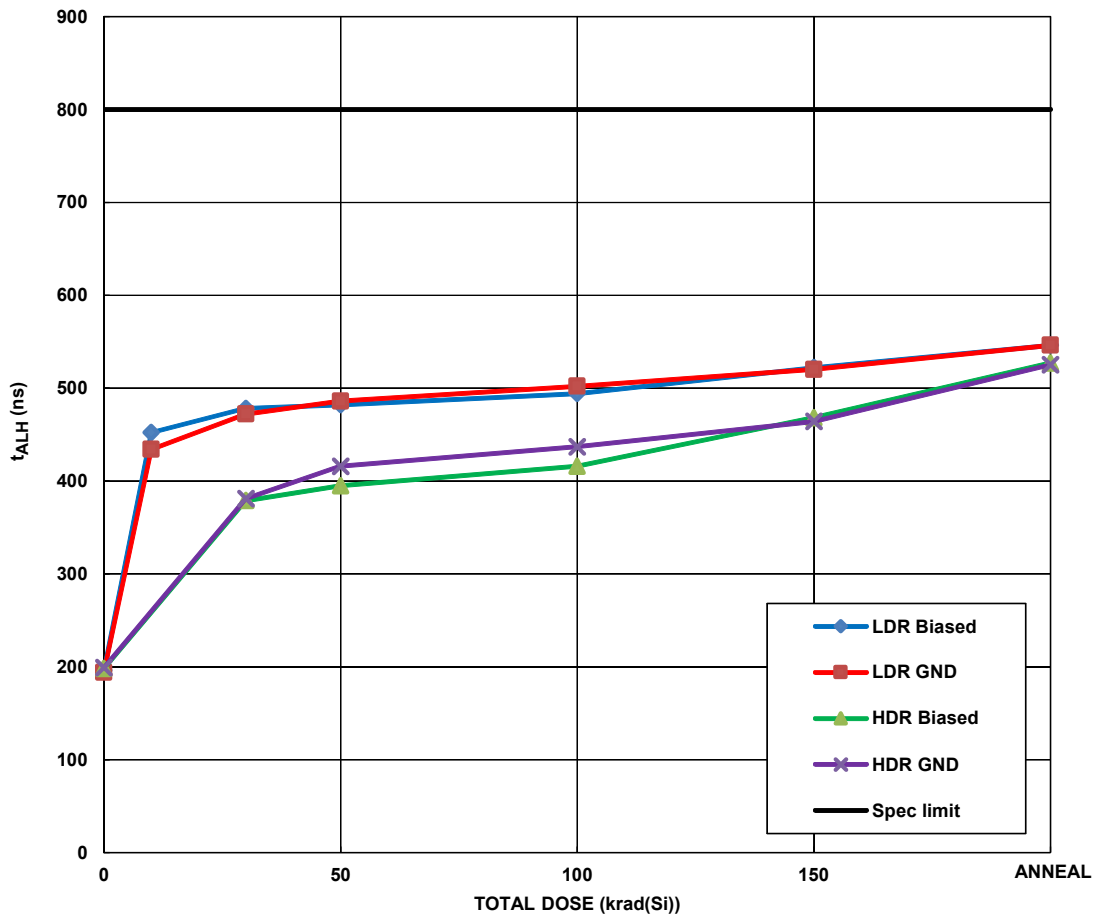

FIGURE 36. ISL71841SEH address to output access time, LOW to HIGH, supply voltage $\pm 12.0V$, as a function of total dose irradiation at high and low dose rate for the biased (Figure 2) and unbiased (all pins grounded) cases. The low dose rate was 0.0085rad(Si)/s and the high dose rate was 69.7rad(Si)/s . Irradiations were followed by a 168-hour biased anneal at $+100^\circ\text{C}$. Sample size for the low dose rate cells was 13 and sample size for the high dose rate cells was 4. The post-irradiation SMD limit is 800ns maximum.

Variables Data Plots (Continued)

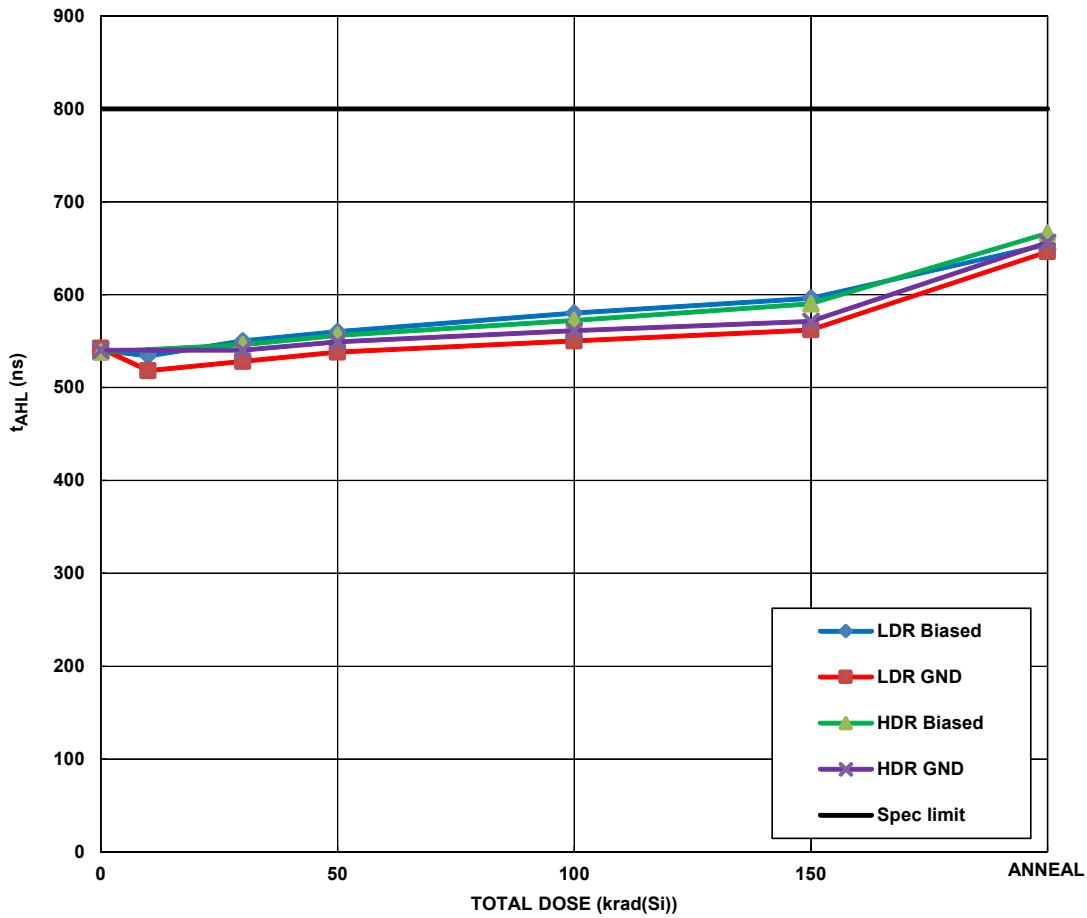

FIGURE 37. ISL71841SEH address to output access time, HIGH-to-LOW, supply voltage $\pm 12.0V$, as a function of total dose irradiation at high and low dose rate for the biased (Figure 2) and unbiased (all pins grounded) cases. The low dose rate was 0.0085rad(Si)/s and the high dose rate was 69.7rad(Si)/s . Irradiations were followed by a 168-hour biased anneal at $+100^\circ\text{C}$. Sample size for the low dose rate cells was 13 and sample size for the high dose rate cells was 4. The post-irradiation SMD limit is 800ns maximum.

Variables Data Plots (Continued)

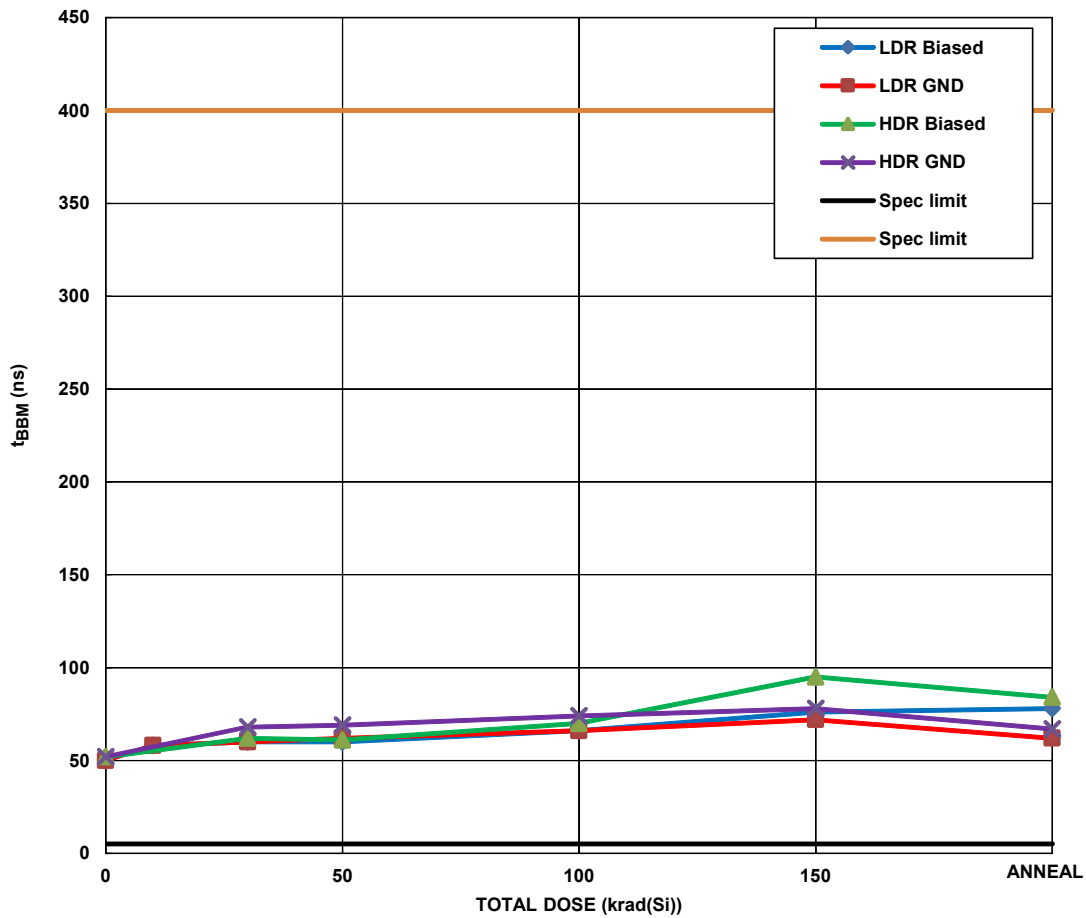

FIGURE 38. ISL71841SEH break-before-make time delay, supply voltage $\pm 12.0V$, as a function of total dose irradiation at high and low dose rate for the biased (Figure 2) and unbiased (all pins grounded) cases. The low dose rate was $0.0085\text{rad(Si)}/\text{s}$ and the high dose rate was $69.7\text{rad(Si)}/\text{s}$. Irradiations were followed by a 168-hour biased anneal at $+100^\circ\text{C}$. Sample size for the low dose rate cells was 13 and sample size for the high dose rate cells was 4. The post-irradiation SMD limits are 5ns to 400ns.

Variables Data Plots (Continued)

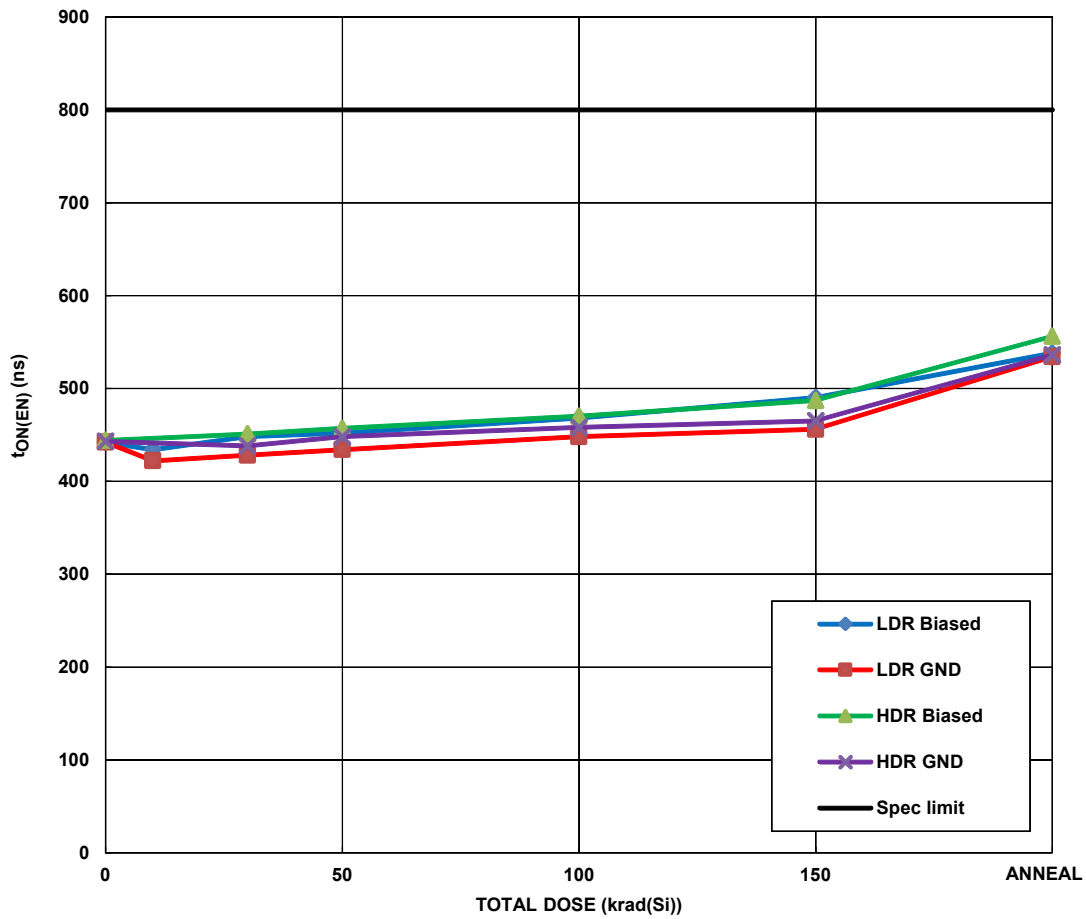

FIGURE 39. ISL71841SEH enable to output ON delay, supply voltage $\pm 12.0V$, as a function of total dose irradiation at high and low dose rate for the biased (Figure 2) and unbiased (all pins grounded) cases. The low dose rate was $0.0085\text{rad(Si)}/\text{s}$ and the high dose rate was $69.7\text{rad(Si)}/\text{s}$. Irradiations were followed by a 168-hour biased anneal at $+100^\circ\text{C}$. Sample size for the low dose rate cells was 13 and sample size for the high dose rate cells was 4. The post-irradiation SMD limit is 800ns maximum.

Variables Data Plots (Continued)

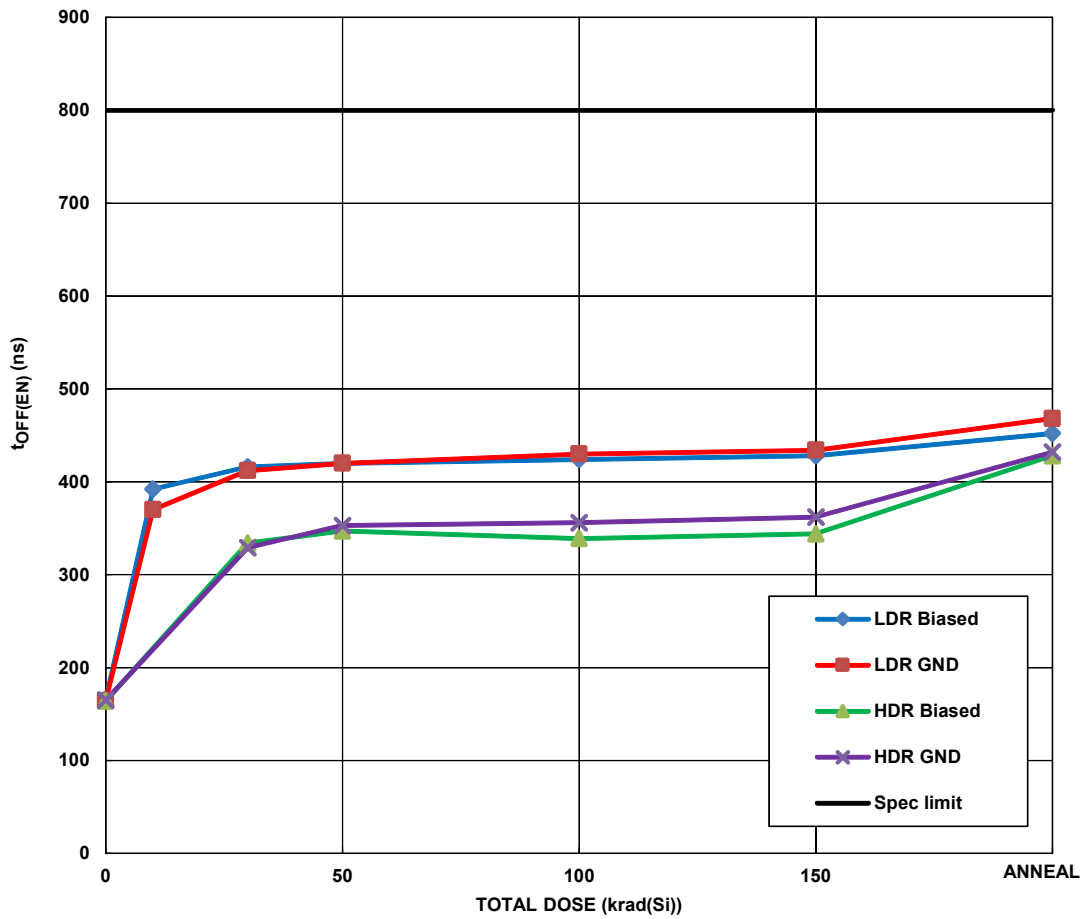

FIGURE 40. ISL71841SEH enable to output OFF delay, supply voltage $\pm 12.0V$, as a function of total dose irradiation at high and low dose rate for the biased (Figure 2) and unbiased (all pins grounded) cases. The low dose rate was 0.0085rad(Si)/s and the high dose rate was 69.7rad(Si)/s . Irradiations were followed by a 168-hour biased anneal at $+100^\circ\text{C}$. Sample size for the low dose rate cells was 13 and sample size for the high dose rate cells was 4. The post-irradiation SMD limit is 800ns maximum.

Variables Data Plots (Continued)

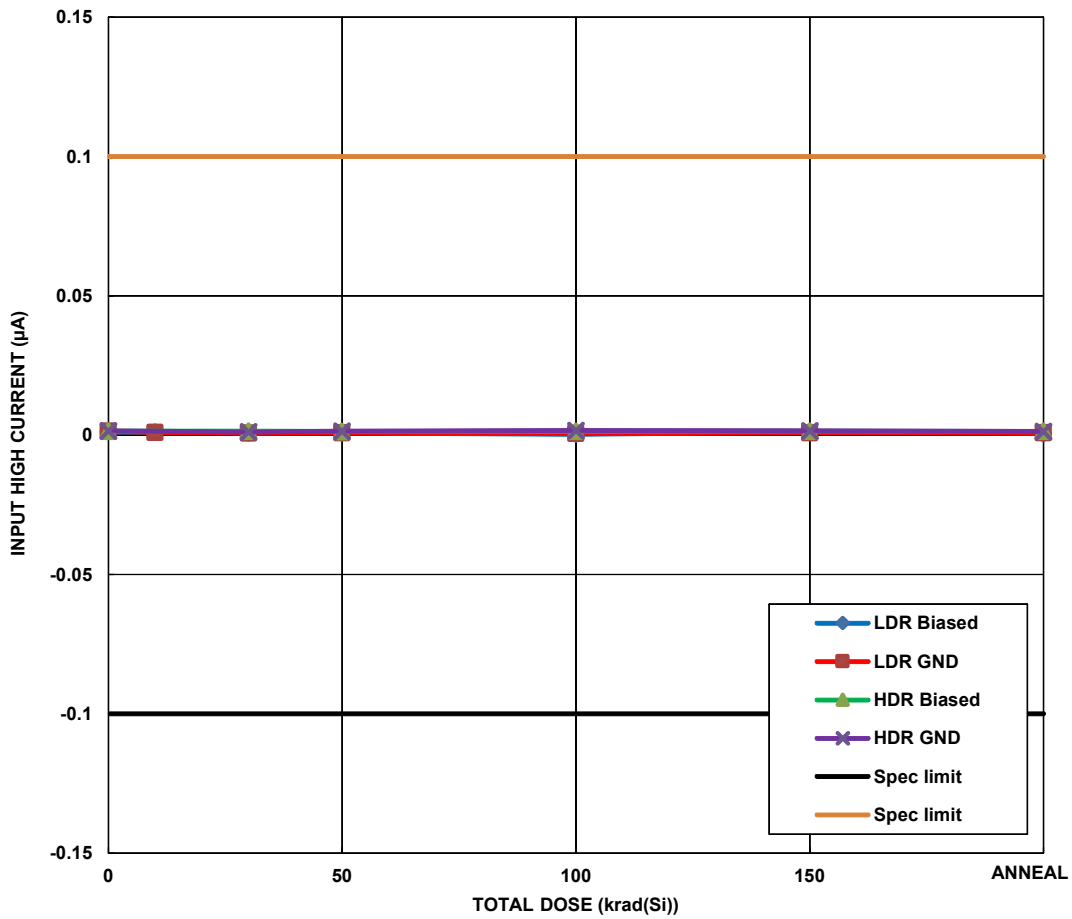

FIGURE 41. ISL71841SEH input HIGH current, average of all five addresses and ENABLE, as a function of total dose irradiation at high and low dose rate for the biased (Figure 2) and unbiased (all pins grounded) cases. The low dose rate was 0.0085rad(Si)/s and the high dose rate was 69.7rad(Si)/s. Irradiations were followed by a 168-hour biased anneal at +100 °C. Sample size for the low dose rate cells was 13 and sample size for the high dose rate cells was 4. The post-irradiation SMD limits are -0.1µA to 1.0µA.

Variables Data Plots (Continued)

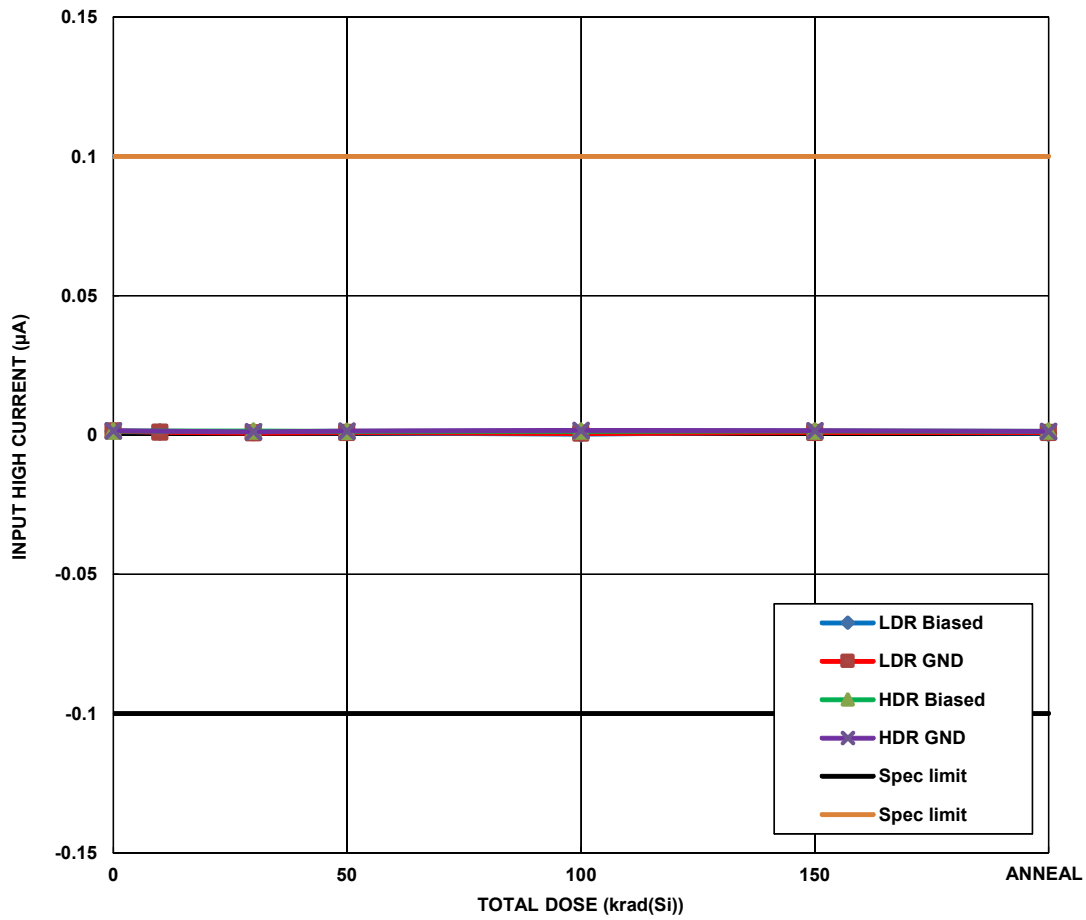

FIGURE 42. ISL71841SEH input LOW current, average of all five addresses and ENABLE, as a function of total dose irradiation at high and low dose rate for the biased (Figure 2) and unbiased (all pins grounded) cases. The low dose rate was 0.0085rad(Si)/s and the high dose rate was 69.7rad(Si)/s. Irradiations were followed by a 168-hour biased anneal at +100°C. Sample size for the low dose rate cells was 13 and sample size for the high dose rate cells was 4. The post-irradiation SMD limits are -0.1µA to 1.0µA.

Variables Data Plots (Continued)

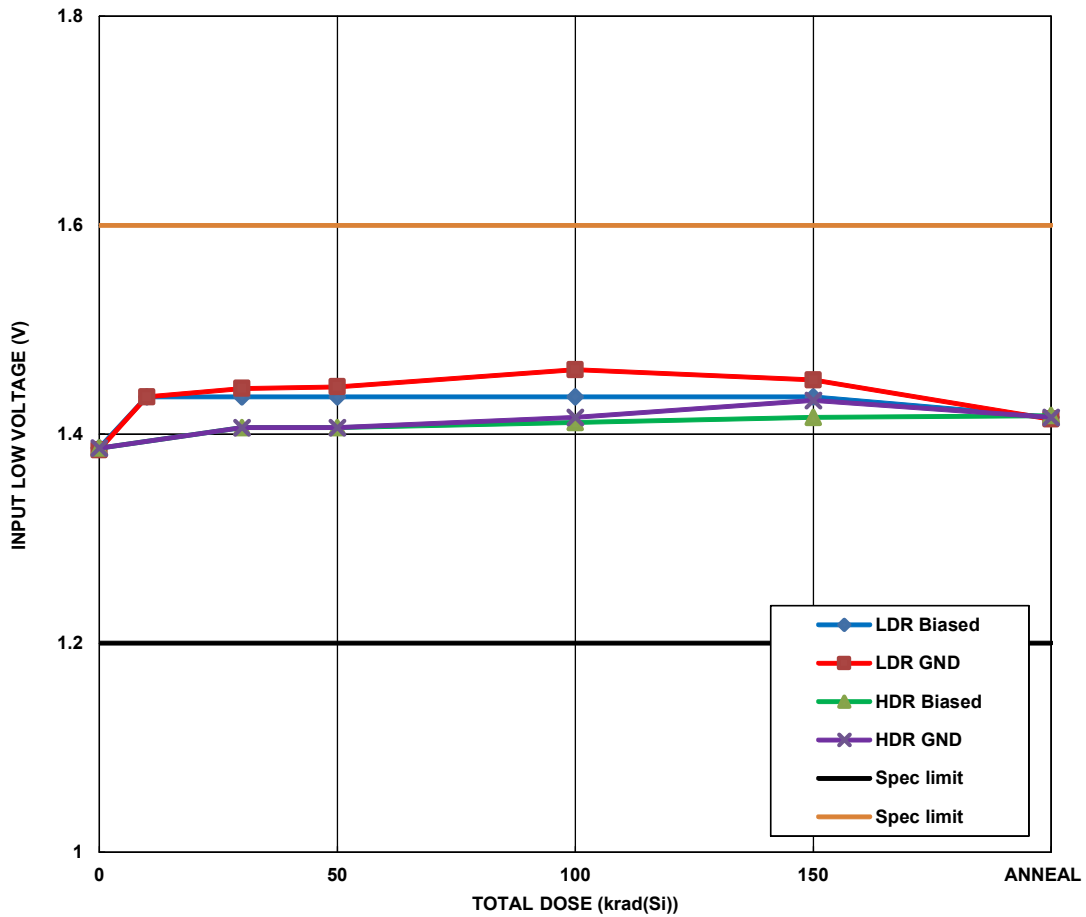

FIGURE 43. ISL71841SEH input LOW voltage, average of all five addresses and ENABLE, as a function of total dose irradiation at high and low dose rate for the biased (Figure 2) and unbiased (all pins grounded) cases. The low dose rate was 0.0085rad(Si)/s and the high dose rate was 69.7rad(Si)/s. Irradiations were followed by a 168-hour biased anneal at +100 °C. Sample size for the low dose rate cells was 13 and sample size for the high dose rate cells was 4. The post-irradiation SMD limits are 1.2V to 1.6V.

Variables Data Plots (Continued)

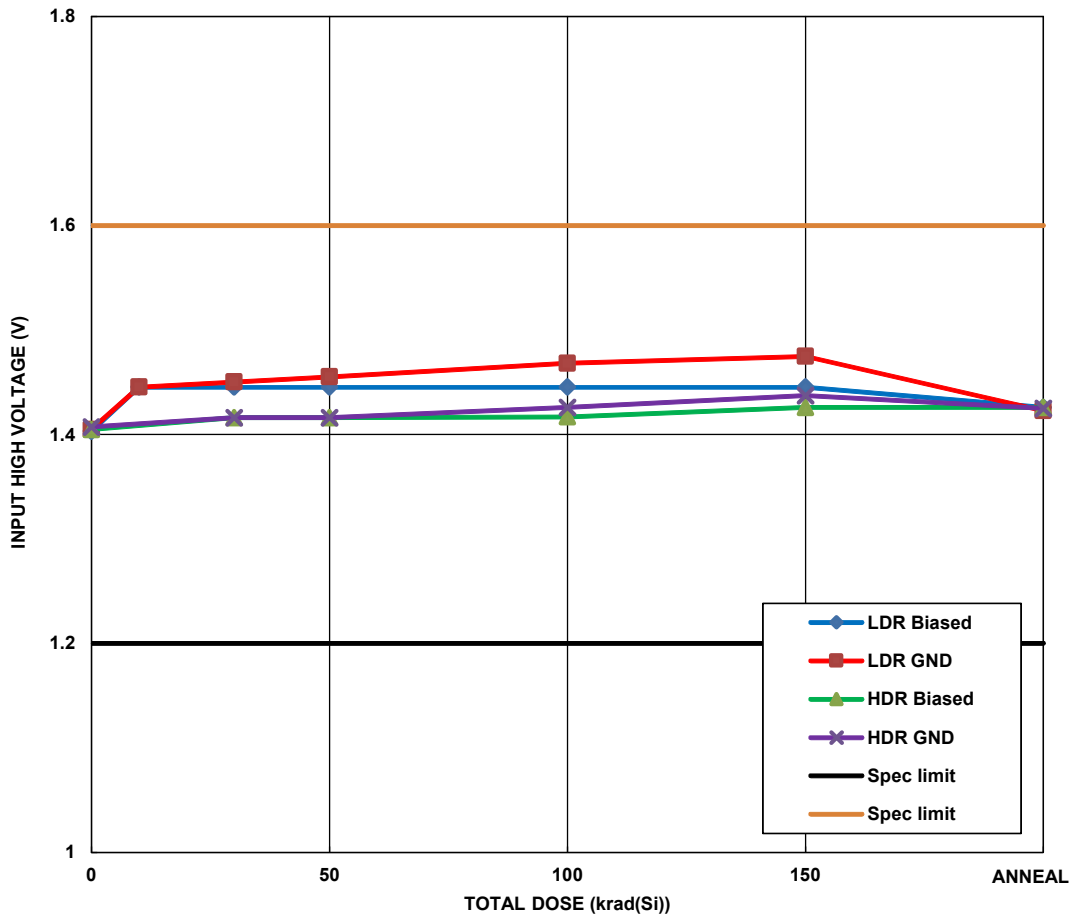

FIGURE 44. ISL71841SEH input HIGH voltage, average of all five addresses and ENABLE, as a function of total dose irradiation at high and low dose rate for the biased (Figure 2) and unbiased (all pins grounded) cases. The low dose rate was 0.0085rad(Si)/s and the high dose rate was 69.7rad(Si)/s. Irradiations were followed by a 168-hour biased anneal at +100°C. Sample size for the low dose rate cells was 13 and sample size for the high dose rate cells was 4. The post-irradiation SMD limits are 1.2V to 1.6V.

Conclusion

This document reports results of ^{60}Co total dose testing of the ISL71841SEH 32-channel analog multiplexer. Parts were tested at low and high dose rate-under biased and unbiased conditions as outlined in MIL-STD-883 Test Method 1019. All irradiations were followed by a 168-hour biased anneal at +100°C.

The attributes data is presented in [Table 1](#), while variables data for selected parameters is presented in [Figures 3](#) through [44](#). Several rejects were encountered after the 150krad(Si) low dose rate irradiation and subsequent anneal, for both the biased and unbiased cases. These rejects were for the ON-resistance flatness parameter at 5V input voltage and were marginal failures. We plot the parameter's median in [Figure 12](#) and have provided additional detail in [Figures 13](#) and [14](#), which show the ON-resistance match as a function of total dose irradiation at low dose rate only ([Figure 13](#)) and at high dose rate only ([Figure 14](#)).

The low dose rate results are clearly worst case. The post-irradiation SMD limit is 20 Ω maximum. The ON-resistance flatness parameter for the -5V input voltage case showed good stability.

There were no rejects against the Group A limits at the SMD rating of 100krad(Si) at either dose rate, and the part is considered low dose rate insensitive up to its SMD total dose limits. Similarly, no differences between biased and unbiased irradiation were noted, and the part is not considered bias sensitive.

TABLE 2. REPORTED PARAMETER

FIGURE	PARAMETER	LIMIT LOW	LIMIT HIGH	UNIT	NOTES
3	Positive Supply Current	-	400	μA	$\pm 15\text{V}$ supplies
4	Negative Supply Current	-400	-	μA	$\pm 15\text{V}$ supplies
5	Positive Standby Supply Current	-	400	μA	$\pm 15\text{V}$ supplies
6	Negative Standby Supply Current	-400	-	μA	$\pm 15\text{V}$ supplies
7	Supply Current Into VREF	-	35	μA	$\pm 15\text{V}$ supplies
8	Switch ON-resistance, Average	-	500	Ω	$V_{\text{IN}} = 5\text{V}$
9	Switch ON-resistance, Average	-	700	Ω	$V_{\text{IN}} = 15\text{V}$
10	Switch ON-resistance, Average	-	700	Ω	$V_{\text{IN}} = -15\text{V}$
11	Switch ON-resistance, Average	-	500	Ω	$V_{\text{IN}} = -5\text{V}$
12	ON-resistance Match, Average	-	20	Ω	$V_{\text{IN}} = 5\text{V}$
15	ON-resistance Match, Average	-	20	Ω	$V_{\text{IN}} = -5\text{V}$
16	OFF Source Leakage, Average	-100	100	nA	$V_{\text{IN}} = 11.5\text{V}$
17	OFF Source Leakage, Average	-100	100	nA	$V_{\text{IN}} = -11.5\text{V}$
18	OFF Source Leakage, Average	-750	750	nA	35V overvoltage
19	OFF Source Leakage, Average	-750	750	nA	-35V overvoltage
20	OFF drain leakage, average	-500	500	nA	Power OFF, 35V overvoltage
21	OFF Drain Leakage, Average	-500	500	nA	Power OFF, -35V overvoltage
22	ON Source Leakage, Average	-500	500	nA	35V overvoltage
23	ON Source Leakage, Average	-500	500	nA	-35V overvoltage
24	OFF Source Leakage, Average	-100	100	nA	Power OFF
25	OFF Source Leakage, Average	-100	100	nA	Power OFF
26	ON Drain Leakage, Average	-100	100	nA	Source and drain at 10V
27	ON Drain Leakage, Average	-100	100	nA	Source and drain at -10V
28	ON Drain Leakage	-80	80	nA	Part disabled
29	ON Drain Leakage	-80	80	nA	Part disabled
31	Access Time, LOW to HIGH	-	800	ns	$\pm 15\text{V}$ supplies
32	Access Time, HIGH to LOW	-	800	ns	$\pm 15\text{V}$ supplies

TABLE 2. REPORTED PARAMETER (Continued)

FIGURE	PARAMETER	LIMIT LOW	LIMIT HIGH	UNIT	NOTES
33	Break-before-make Time	5	400	ns	±15V supplies
34	Enable ON to Output Delay	-	800	ns	±15V supplies
35	Enable OFF to Output Delay	-	800	ns	±15V supplies
36	Access Time, LOW-to-HIGH	-	800	ns	±12V supplies
37	Access Time, HIGH-to-LOW	-	800	ns	±12V supplies
38	Break-before-make time	5	400	ns	±12V supplies
39	Enable ON to Output Delay	-	800	ns	±12V supplies
40	Enable OFF to Output Delay	-	800	ns	±12V supplies
41	Input HIGH Current, Average	-100	100	nA	A0 – A4 and ENABLE
42	Input LOW Current, Average	-100	100	nA	A0 – A4 and ENABLE
43	Input LOW Voltage, Average	1.2	1.6	V	A0 – A4 and ENABLE
44	Input HIGH Voltage, Average	1.2	1.6	V	A0 – A4 and ENABLE

NOTE: Limits are taken from Standard Microcircuit Drawing (SMD) [5962-15220](#).

Revision History

REVISION	DATE	DESCRIPTION
1.01	Dec 8, 2022	Updated Introduction to include ISL73841SEH reference. Added Revision History section.
1.00	Feb 25, 2016	Added 150krad(Si) low dose rate information throughout document.
0.00	Jul 9, 2015	Initial release

IMPORTANT NOTICE AND DISCLAIMER

RENESAS ELECTRONICS CORPORATION AND ITS SUBSIDIARIES (“RENESAS”) PROVIDES TECHNICAL SPECIFICATIONS AND RELIABILITY DATA (INCLUDING DATASHEETS), DESIGN RESOURCES (INCLUDING REFERENCE DESIGNS), APPLICATION OR OTHER DESIGN ADVICE, WEB TOOLS, SAFETY INFORMATION, AND OTHER RESOURCES “AS IS” AND WITH ALL FAULTS, AND DISCLAIMS ALL WARRANTIES, EXPRESS OR IMPLIED, INCLUDING, WITHOUT LIMITATION, ANY IMPLIED WARRANTIES OF MERCHANTABILITY, FITNESS FOR A PARTICULAR PURPOSE, OR NON-INFRINGEMENT OF THIRD PARTY INTELLECTUAL PROPERTY RIGHTS.

These resources are intended for developers skilled in the art designing with Renesas products. You are solely responsible for (1) selecting the appropriate products for your application, (2) designing, validating, and testing your application, and (3) ensuring your application meets applicable standards, and any other safety, security, or other requirements. These resources are subject to change without notice. Renesas grants you permission to use these resources only for development of an application that uses Renesas products. Other reproduction or use of these resources is strictly prohibited. No license is granted to any other Renesas intellectual property or to any third party intellectual property. Renesas disclaims responsibility for, and you will fully indemnify Renesas and its representatives against, any claims, damages, costs, losses, or liabilities arising out of your use of these resources. Renesas' products are provided only subject to Renesas' Terms and Conditions of Sale or other applicable terms agreed to in writing. No use of any Renesas resources expands or otherwise alters any applicable warranties or warranty disclaimers for these products.

(Rev.1.0 Mar 2020)

Corporate Headquarters

TOYOSU FORESIA, 3-2-24 Toyosu,
Koto-ku, Tokyo 135-0061, Japan
www.renesas.com

Contact Information

For further information on a product, technology, the most up-to-date version of a document, or your nearest sales office, please visit:
www.renesas.com/contact/

Trademarks

Renesas and the Renesas logo are trademarks of Renesas Electronics Corporation. All trademarks and registered trademarks are the property of their respective owners.