ISL78845ASRH

Total Dose Test Report

Introduction

This report summarizes the results of a Low Dose Rate (LDR) and High Dose Rate (HDR) total dose test of the ISL78845ASRH current mode PWM controller. The test was conducted to determine the sensitivity of the part to the total dose environment and to LDR irradiation in particular.

The [ISL78845ASRH](#) is available in twelve versions differing in undervoltage lockout, maximum duty cycle characteristics, and Total Ionizing Dose (TID) acceptance testing; see the datasheet for details. The ISL78840ASRH, ISL78841ASRH, ISL78843ASRH, and ISL78845ASRH are acceptance tested on a wafer-by-wafer basis to 100krad(Si) at HDR (50–300rad(Si)/s) only. The ISL78840ASEH, ISL78841ASEH, ISL78843ASEH, and ISL78845ASEH are acceptance tested on a wafer-by-wafer basis to 100krad(Si) at HDR (50-300rad(Si)/s) and to 50krad(Si) at LDR (0.01rad(Si)/s). The ISL738840ASEH, ISL738841ASEH, ISL738843ASEH, and ISL738845ASEH are acceptance tested on a wafer-by-wafer basis to 50krad(Si) at LDR (0.01rad(Si)/s). The HDR and LDR performance of the ISL78845ASRH is considered representative of the other devices in the ISL7884x and ISL73884x family.

Related Literature

For a full list of related documents, visit our website:

- [ISL78845ASRH](#) device page
- MIL-STD-883G test method 1019.7
- MIL-PRF-38535 (QML)

Product Description

The ISL78845ASRH is a high performance, radiation hardened drop-in replacement for the popular 28C4x and 18C4x PWM controllers suitable for a wide range of power conversion applications including boost, flyback and isolated output configurations. Its fast signal propagation and output switching characteristics make this an ideal product for existing and new designs.

Features include up to 13.2V operation, low operating current, 90µA typical pre-irradiation start-up current, adjustable operating frequency to 1MHz, and 1A peak gate drive capability with 50ns rise and fall times. For a full list of features see the [ISL78845ASRH](#) datasheet.

The ISL78845ASRH is produced in conformance with MIL-PRF-38535 (QML). Specifications for radiation hardness assured (RHA) QML devices are controlled by the Defense Supply Center (DSCC) in Columbus, OH. The SMD numbers listed in the ordering information must be used when ordering. Detailed Electrical Specifications for the ISL788xASRH are contained in SMD [5962-07249](#).

The ISL78845ASRH is part of a family of current-mode PWM controllers differing in undervoltage lockout and maximum duty cycle characteristics. Other parts in the product family include the ISL78840ASRH (7.0V rising UVLO voltage, 100% maximum duty cycle), the ISL78841ASRH (7.0V rising UVLO voltage, 50% maximum duty cycle) and the ISL78843ASRH (8.4V rising UVLO voltage, 100% maximum duty cycle).

The ISL78845ASRH is implemented in a junction isolated submicron BiCMOS process optimized for power management applications, with 0.6µm minimum ground rules and three layers of interconnect. Active devices include low voltage CMOS, high voltage DMOS devices, and complementary bipolars. The process is in volume production under MIL-PRF-38535 certification and is used for a wide range of commercial power management devices.

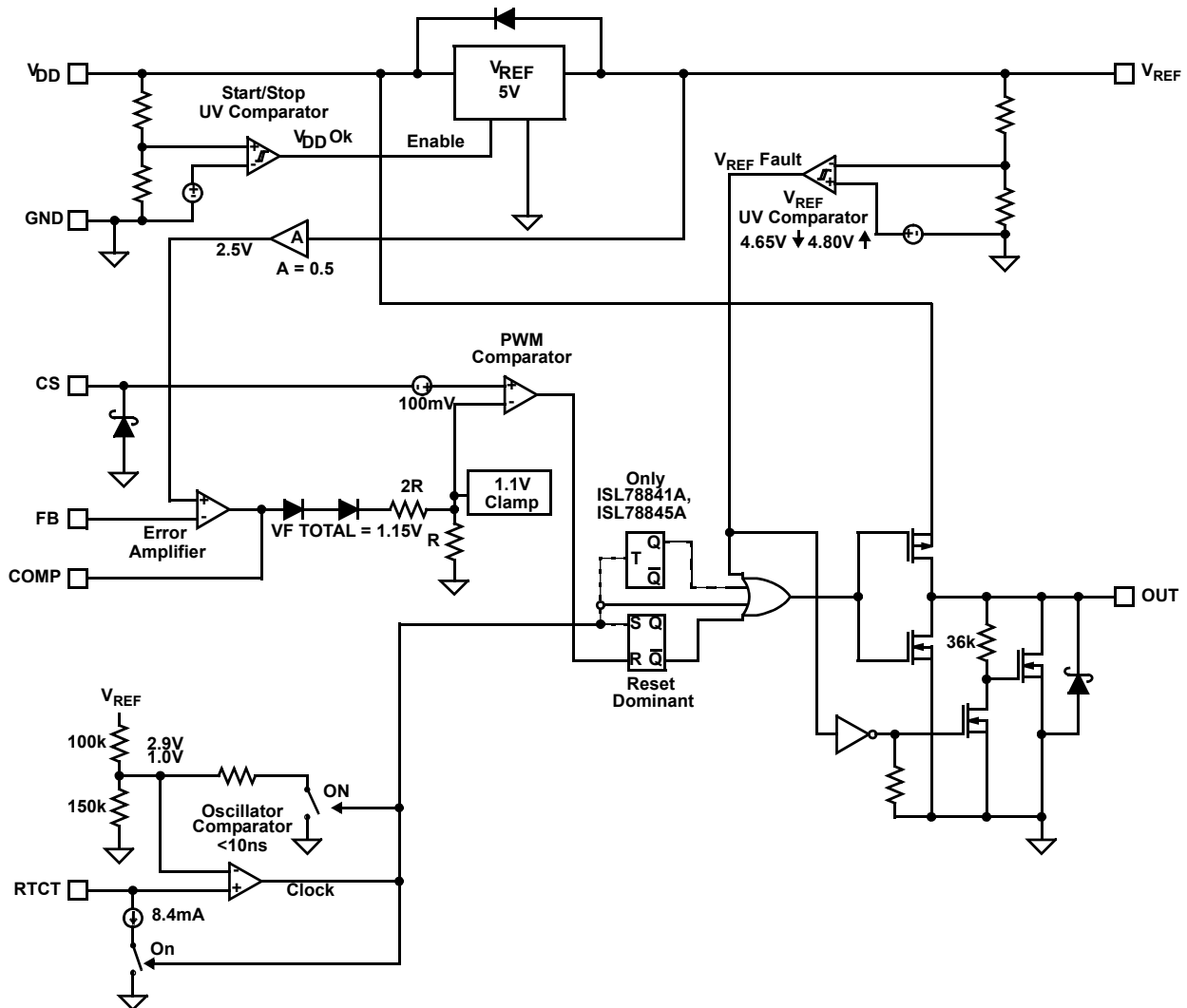

Figure 1. ISL78845ASRH Block Diagram

1. Test Description

1.1 Irradiation Facilities

HDR testing was performed using a Gammacell 220 ⁶⁰Co irradiator located in the Renesas Palm Bay, Florida facility. LDR testing used a J. L. Shepherd and Associates (JLS) LDR ⁶⁰Co model 484 irradiator located in the same facility. The HDR irradiations were done at 55rad(Si)/s and the LDR work was performed at 0.010rad(Si)/s, both per MIL-STD-883 Method 1019. Dosimetry for both tests was performed using Far West Technology radiochromic dosimeters and on-site readout equipment. A PbAl box was used to shield the test fixture and devices under test against low energy secondary gamma radiation as required by MIL-STD-883.

1.2 Test Fixturing

[Figure 2 on page 3](#) shows the configuration used for biased irradiation. This configuration was used for both LDR and HDR irradiation. The unbiased LDR irradiation was carried out with all pins grounded.

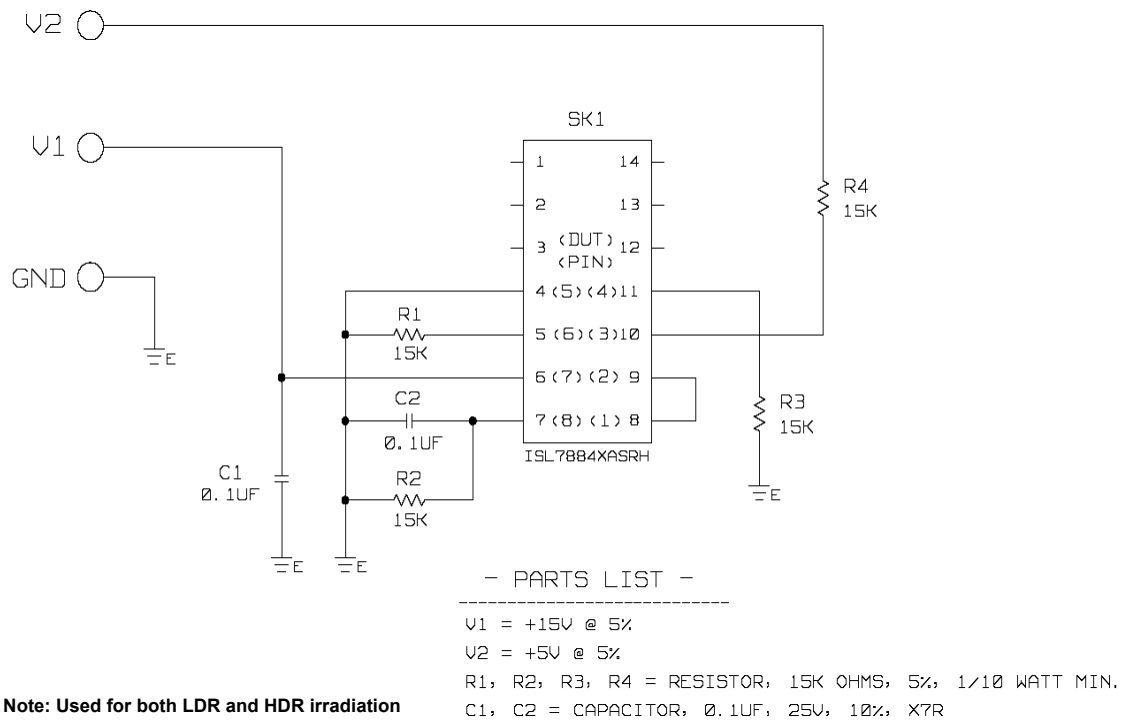

Figure 2. ISL78845ASRH Irradiation Bias Configuration

1.3 Characterization Equipment and Procedures

All electrical testing was performed outside the irradiator using the production Automated Test Equipment (ATE) with datalogging of all parameters at each downpoint. Downpoint electrical testing was performed at room temperature.

1.4 Experimental Matrix

The experimental matrix consisted of three cells:

- Four samples irradiated at HDR under bias
- Four samples irradiated at LDR with all pins grounded
- Four samples irradiated at LDR under bias.

This experimental approach was consistent with a first engineering test of the part but was not in full compliance with the guidelines of MIL-STD-883 Test Method 1019.

Samples of the ISL78845ASRH were drawn from preproduction inventory and were packaged in the standard hermetic 8 Ld Ceramic Flatpack (CFP) production package. Samples were processed through the standard burn-in cycle before irradiation, as required by MIL-STD-883, and were screened to the SMD 5962-07249 limits at room, low, and high temperature before the test.

1.5 Downpoints

The downpoints were zero, 50krad(Si), 75krad(Si), 100krad(Si), and 150krad(Si) for the LDR test and zero, 50krad(Si), 75krad(Si), 100krad(Si), and 125krad(Si) for the HDR test.

2. Results

2.1 Attributes Data

Table 1. ISL78845ASRH Total Dose Test Attributes Data

Part	Dose Rate (Note 1)	Bias	Sample Size	Downpoint	Pass (Note 2)	Rejects
ISL78845ASRH	LDR	Biased	4	Pre-irradiation	4	0
				50krad(Si)	4	0
				75krad(Si)	4	0
				100krad(Si)	4	0
				150krad(Si)	4	0
ISL78845ASRH	LDR	Grounded	4	Pre-irradiation	4	0
				50krad(Si)	4	0
				75krad(Si)	4	0
				100krad(Si)	4	0
				150krad(Si)	4	0
ISL78845ASRH	HDR	Biased	4	Pre-irradiation	4	0
				50krad(Si)	4	0
				75krad(Si)	4	0
				100krad(Si)	4	0
				125krad(Si)	4	0

Notes:

1. 'HDR' indicates high dose rate while 'LDR' indicates low dose rate.
2. 'Pass' indicates a sample that passes all post-irradiation SMD limits.

2.2 Variables Data

The plots in [Figures 3](#) through [16](#) show data at all downpoints. The plots show the median of 14 key parameters as a function of total dose for each of the three irradiation conditions. We chose to plot the median (as opposed to the mean and standard deviation) because of the small sample sizes involved. All parts showed good stability over irradiation, with no observed LDR sensitivity. ["Reported Parameters" on page 13](#) shows a summary of the parameters plotted in [Figures 3](#) through [16](#). Some of the listed parameters use the symbols defined in SMD 5962-07249; the SMD is mute on the others.

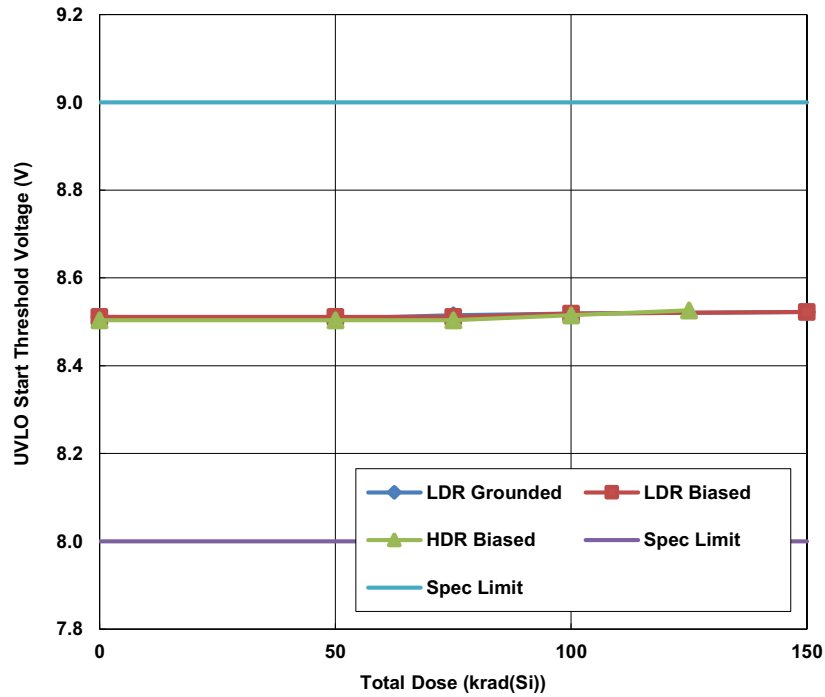

Figure 3. ISL78845ASRH undervoltage lockout Start threshold voltage as a function of total dose irradiation at LDR and HDR. The LDR was 0.01rad(Si)/s and the HDR was 55rad(Si)/s. Sample size for each cell was 4. The post-irradiation SMD limits are 8.0V to 9.0V.

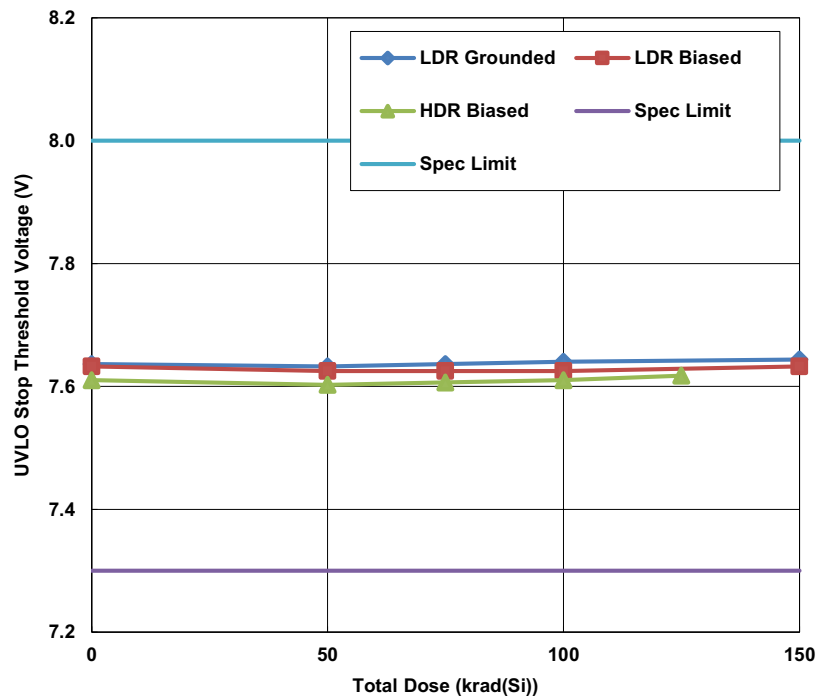

Figure 4. ISL78845ASRH undervoltage lockout Stop threshold voltage as a function of total dose irradiation at LDR and HDR. The LDR was 0.01rad(Si)/s and the HDR was 55rad(Si)/s. Sample size for each cell was 4. The post-irradiation SMD limits are 7.3V to 8.0V.

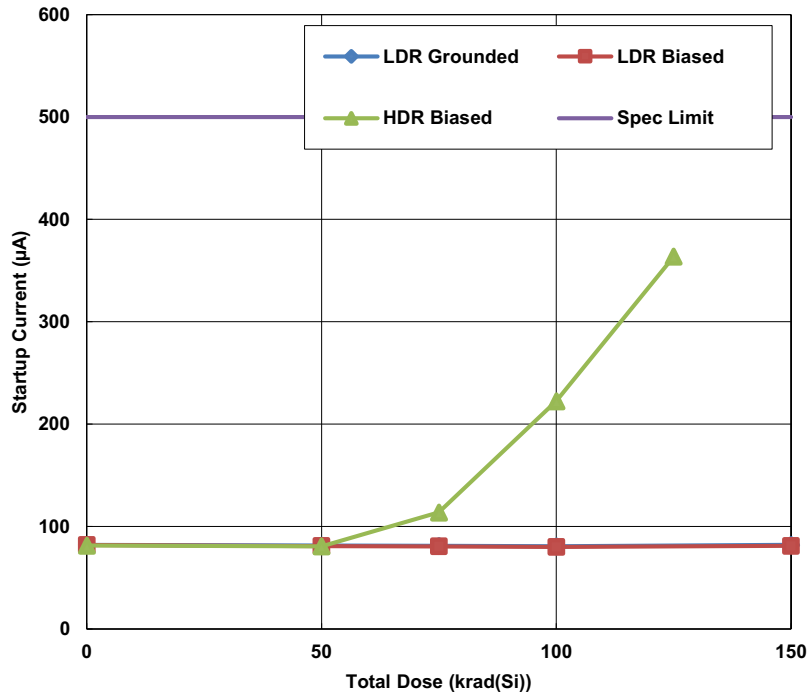

Figure 5. ISL78845ASRH startup current as a function of total dose irradiation at LDR and HDR. The LDR was 0.01rad(Si)/s and the HDR was 55rad(Si)/s. Sample size for each cell was 4. The post-irradiation SMD limit is 500µA maximum.

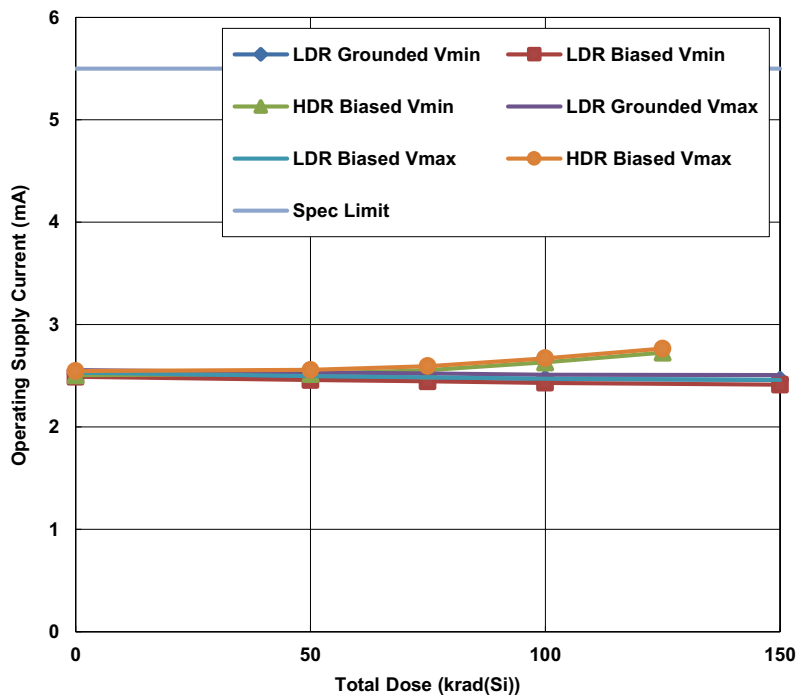

Figure 6. ISL78845ASRH operating supply current as a function of total dose irradiation at LDR and HDR. The LDR was 0.01rad(Si)/s and the HDR was 55rad(Si)/s. Sample size for each cell was 4. The post-irradiation SMD limit is 5.5mA maximum.

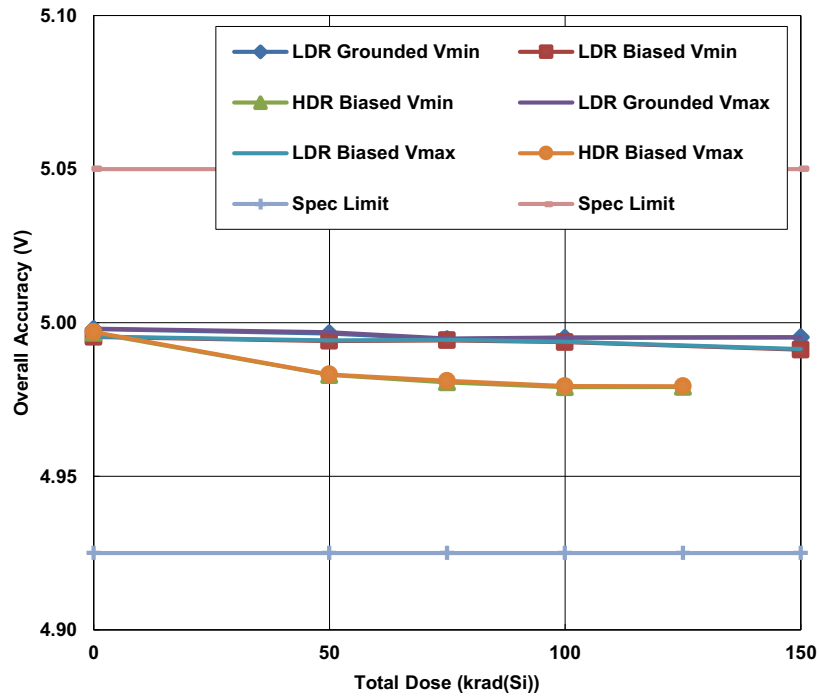

Figure 7. ISL78845ASRH master reference output voltage as a function of total dose irradiation at LDR and HDR. The LDR was 0.01rad(Si)/s and the HDR was 55rad(Si)/s. Sample size for each cell was 4. The post-irradiation SMD limits are 4.925V to 5.050V.

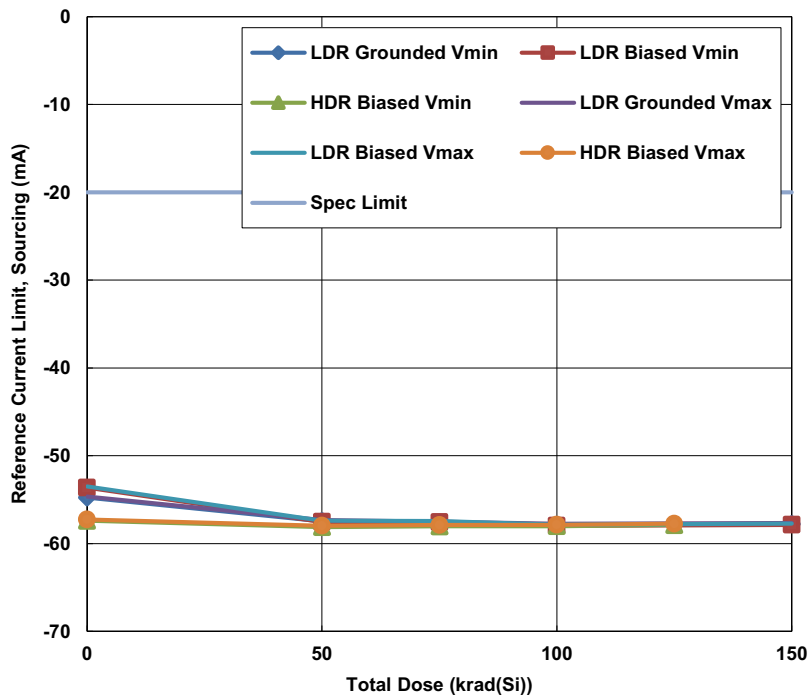

Figure 8. ISL78845ASRH reference current limit, sourcing, as a function of total dose irradiation at LDR and HDR. The LDR was 0.01rad(Si)/s and the HDR was 55rad(Si)/s. Sample size for each cell was 4. The post-irradiation SMD limit is 20mA maximum.

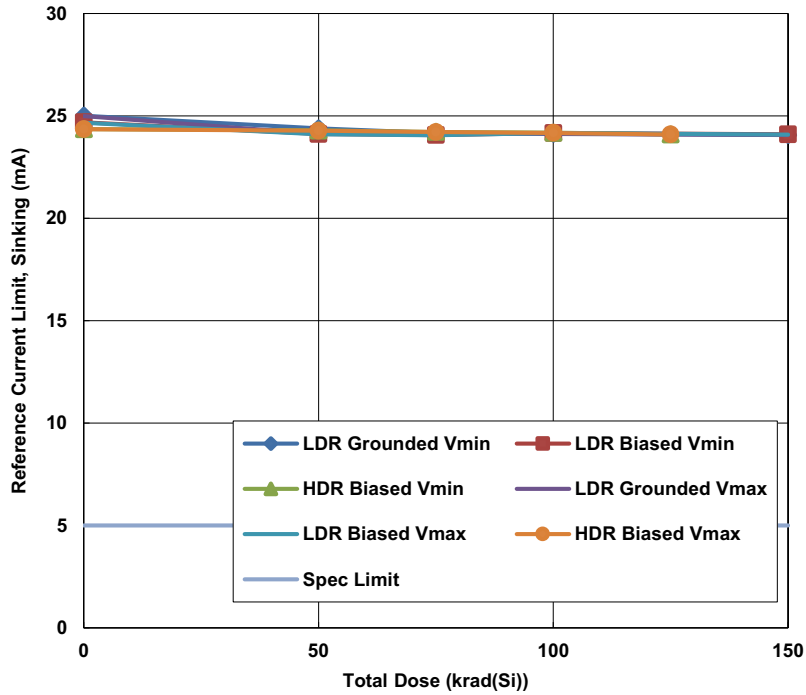

Figure 9. ISL78845ASRH reference current limit, sinking, as a function of total dose irradiation at LDR and HDR. The LDR was 0.01rad(Si)/s and the HDR was 55rad(Si)/s. Sample size for each cell was 4. The post-irradiation SMD limit is 5mA minimum.

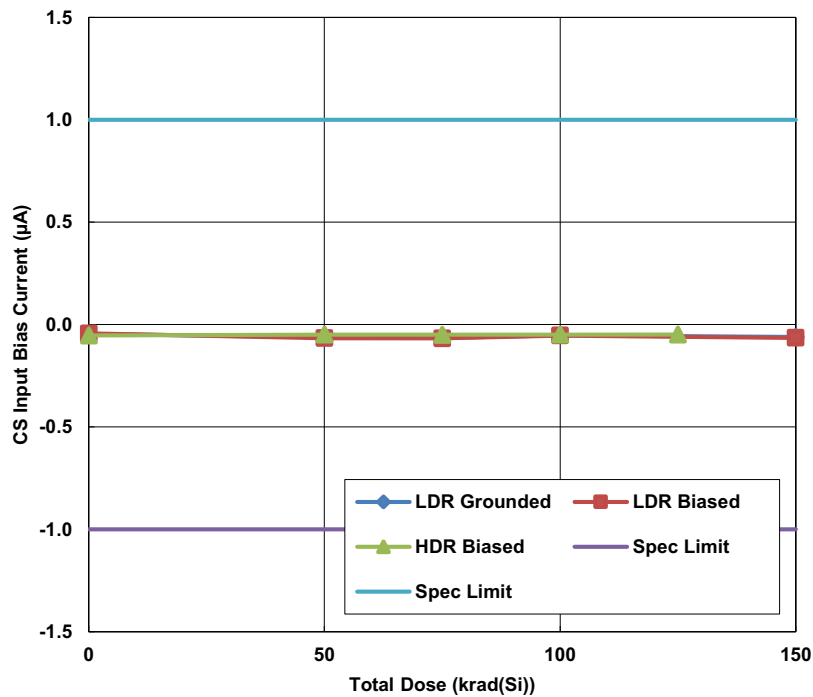

Figure 10. ISL78845ASRH current sense amplifier input bias current as a function of total dose irradiation at LDR and HDR. The LDR was 0.01rad(Si)/s and the HDR was 55rad(Si)/s. Sample size for each cell was 4. The post-irradiation SMD limits are -1.0µA to 1.0µA.

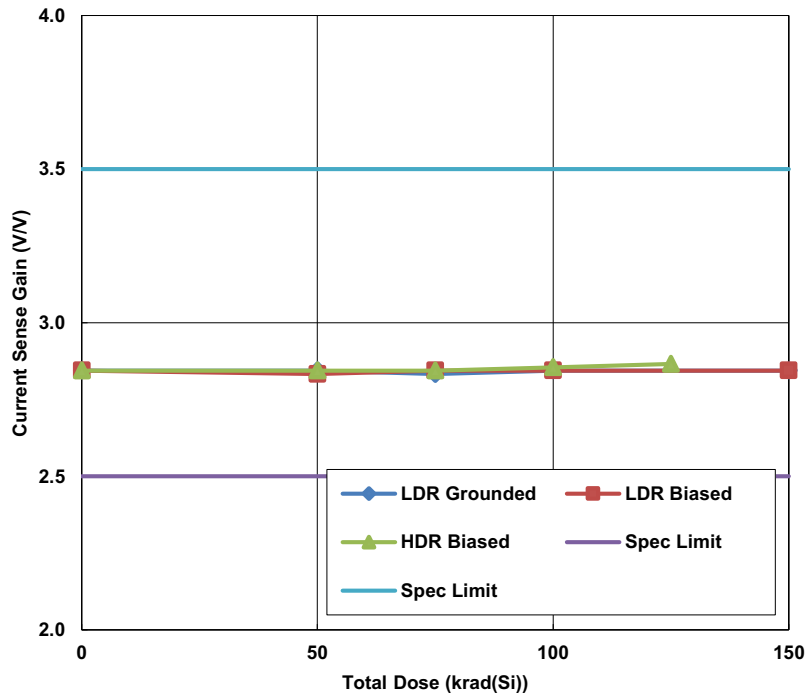

Figure 11. ISL78845ASRH current sense amplifier gain as a function of total dose irradiation at LDR and HDR. The LDR was 0.01rad(Si)/s and the HDR was 55rad(Si)/s. Sample size for each cell was 4. The post-irradiation SMD limits are 2.5V/V to 3.5V/V.

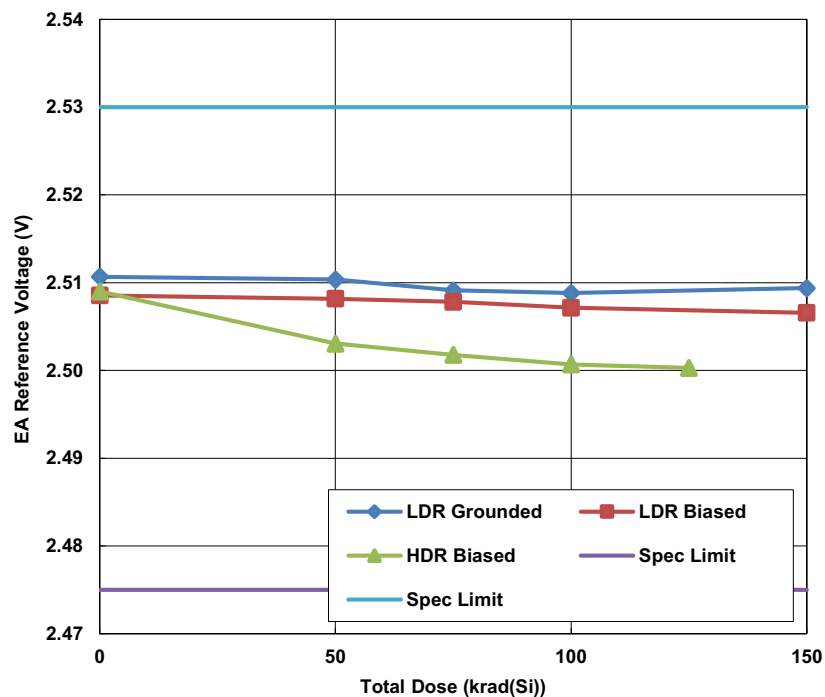

Figure 12. ISL78845ASRH error amplifier reference voltage as a function of total dose irradiation at LDR and HDR. The LDR was 0.01rad(Si)/s and the HDR was 55rad(Si)/s. Sample size for each cell was 4. The post-irradiation SMD limits are 2.475V to 2.530V.

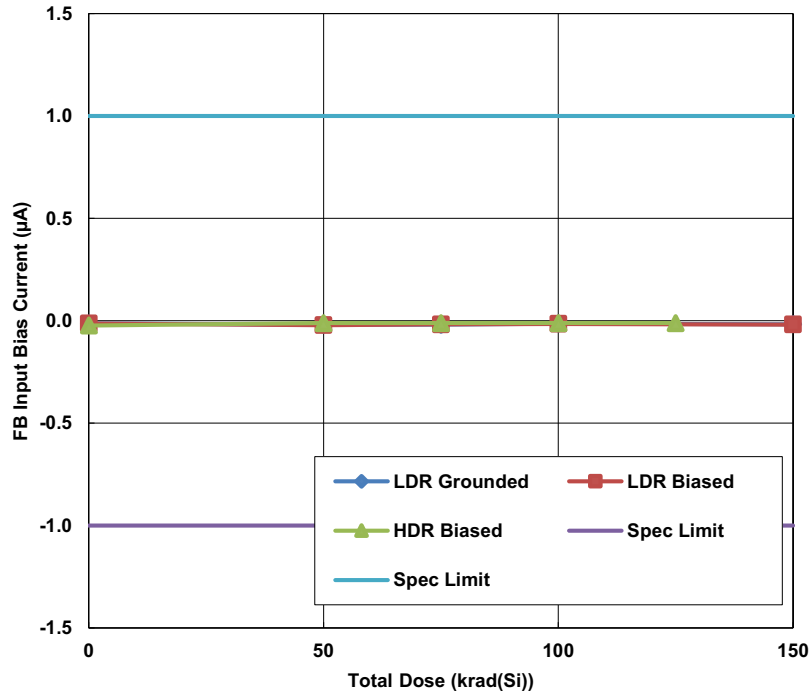

Figure 13. ISL78845ASRH error amplifier feedback pin bias current as a function of total dose irradiation at LDR and HDR. The LDR was 0.01rad(Si)/s and the HDR was 55rad(Si)/s. Sample size for each cell was 4. The post-irradiation SMD limits are -1.0µA to 1.0µA.

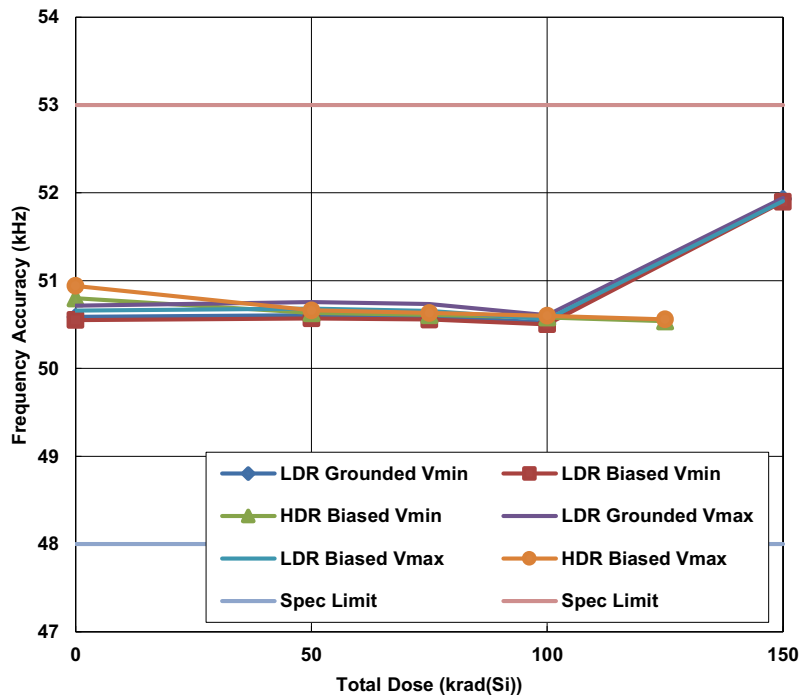

Figure 14. ISL78845ASRH oscillator frequency as a function of total dose irradiation at LDR and HDR. The LDR was 0.01rad(Si)/s and the HDR was 55rad(Si)/s. Sample size for each cell was 4. The post-irradiation SMD limits are 48kHz to 53kHz.

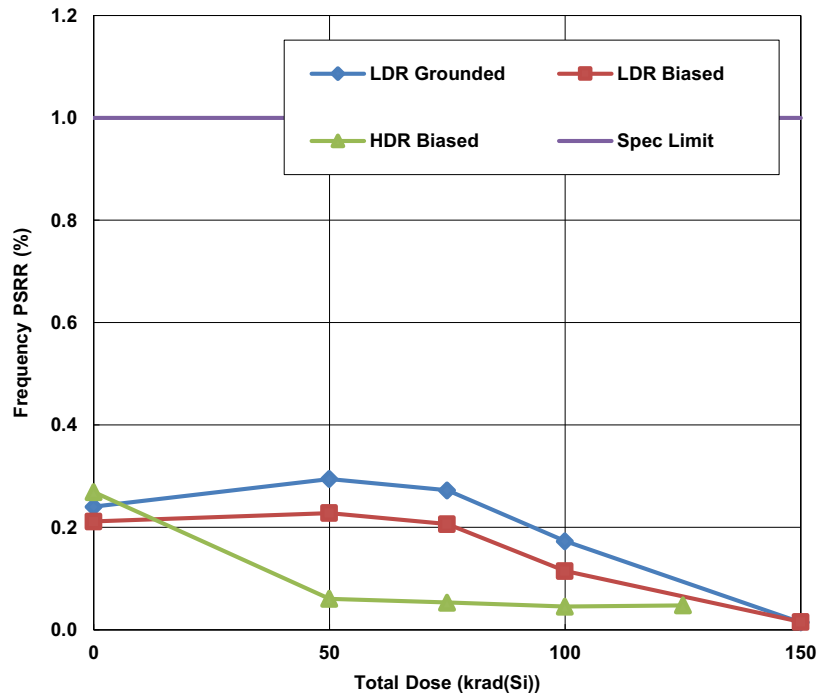

Figure 15. ISL78845ASRH oscillator frequency variation with VDD as a function of total dose irradiation at LDR and HDR. The LDR was 0.01rad(Si)/s and the HDR was 55rad(Si)/s. Sample size for each cell was 4. The post-irradiation SMD limit is 1% maximum.

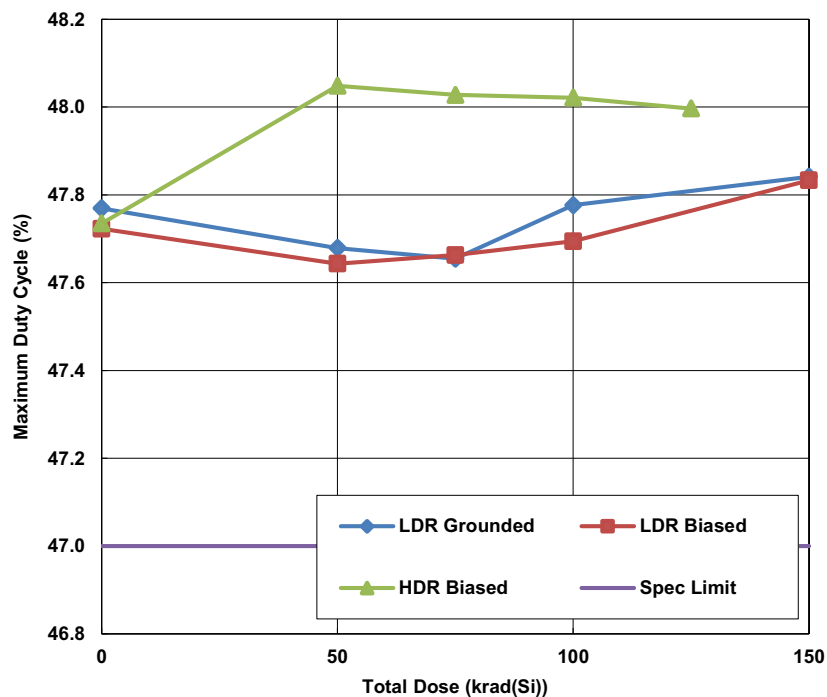

Figure 16. ISL78845ASRH maximum duty cycle as a function of total dose irradiation at LDR and HDR. The LDR was 0.01rad(Si)/s and the HDR was 55rad(Si)/s. Sample size for each cell was 4. The post-irradiation SMD limit is 47% minimum.

3. Discussion

ATE characterization of the samples at all downpoints showed no rejects to the SMD post-irradiation limits. The data is plotted in the figures and generally showed good stability over total dose irradiation. Three figures are interesting.

[Figure 5 on page 6](#) shows startup current as a function of total dose. The two LDR responses are essentially flat over the entire range of the plot, but the HDR curve shows a monotonic increase beginning at the 50krad(Si) point; the curve is well within the 500 μ A SMD post-irradiation limit at 125krad(Si), which is 25krad(Si) above the 100krad(Si) maximum total dose specification of the part. This response is the opposite of classical LDR sensitivity and represents the largely CMOS design of the part. In this sense, the startup current is equivalent to the quiescent supply current parameter (I_{DDQ}) which is commonly used to quantify the radiation hardness of digital logic arrays.

[Figures 7](#) and [12](#) show the master voltage reference output voltage and the error amplifier reference voltage, respectively, as a function of total dose. This behavior is similar to that of the startup current in that the part is more sensitive to HDR than to LDR, but the exact mechanism for these two parameters is not as clear. Both references contain bipolar junction transistors, which would be expected to be LDR sensitive.

All other plotted parameters show little and sometimes no difference between the HDR and LDR response. The conclusion is that the part is not LDR sensitive and displays no bias sensitivity.

4. Conclusion

This document reports interim results of a total dose test of the ISL78845ASRH current-mode PWM controller. Parts were tested at LDR under biased and unbiased conditions to a maximum total dose of 150krad(Si) and were tested at HDR under biased conditions to a maximum total dose of 125krad(Si).

No LDR sensitivity was noted; rather, several parameters appeared to be more sensitive to HDR, an eventuality not foreseen or defined by MIL-STD-883 for parts containing Bipolar Junction Transistors (BJT). Accordingly, the part is considered ELDRS-free up to the 100krad(Si) datasheet total dose rating. It should be noted that this test sequence represented a first look at the response of the part and was not in strict accordance with MIL-STD-883, as a HDR test under unbiased (grounded) conditions was not performed.

Similarly, no differences between biased and unbiased irradiation were noted, and the part is not considered bias sensitive.

5. Appendix

5.1 Reported Parameters

Fig.	Parameter	SMD Symbol	Limits		Unit
			Min	Max	
3	UVLO START Threshold Voltage		8.0	9.0	V
4	UVLO STOP Threshold Voltage		7.3	8.0	V
5	Startup Current	I_{DD}	-	500	μ A
6	Operating Supply Current	I_D	-	5.5	mA
7	Reference Accuracy	V_{REF}	4.925	5.050	V
8	Reference Current Limit, Sourcing		-20	-	mA
9	Reference Current Limit, Sinking		5	-	mA
10	Current Sense Input Bias Current	I_{IB}	-1.0	1.0	μ A
11	Current Sense Gain		2.5	3.5	V/V
12	Error Amplifier Reference Voltage	V_{REF}	2.475	2.530	V
13	Error Amplifier Input Bias Current	FB_{IB}	-1.0	1.0	μ A
14	Oscillator Frequency		48	53	kHz
15	Oscillator Frequency Variation with VDD		-	1.0	%
16	PWM Maximum Duty Cycle		47.0	-	%

6. Revision History

Rev.	Date	Description
0.00	Aug.13.19	Initial release

Notice

1. Descriptions of circuits, software and other related information in this document are provided only to illustrate the operation of semiconductor products and application examples. You are fully responsible for the incorporation or any other use of the circuits, software, and information in the design of your product or system. Renesas Electronics disclaims any and all liability for any losses and damages incurred by you or third parties arising from the use of these circuits, software, or information.
2. Renesas Electronics hereby expressly disclaims any warranties against and liability for infringement or any other claims involving patents, copyrights, or other intellectual property rights of third parties, by or arising from the use of Renesas Electronics products or technical information described in this document, including but not limited to, the product data, drawings, charts, programs, algorithms, and application examples.
3. No license, express, implied or otherwise, is granted hereby under any patents, copyrights or other intellectual property rights of Renesas Electronics or others.
4. You shall not alter, modify, copy, or reverse engineer any Renesas Electronics product, whether in whole or in part. Renesas Electronics disclaims any and all liability for any losses or damages incurred by you or third parties arising from such alteration, modification, copying or reverse engineering.
5. Renesas Electronics products are classified according to the following two quality grades: "Standard" and "High Quality". The intended applications for each Renesas Electronics product depends on the product's quality grade, as indicated below.
 - "Standard": Computers; office equipment; communications equipment; test and measurement equipment; audio and visual equipment; home electronic appliances; machine tools; personal electronic equipment; industrial robots; etc.
 - "High Quality": Transportation equipment (automobiles, trains, ships, etc.); traffic control (traffic lights); large-scale communication equipment; key financial terminal systems; safety control equipment; etc.Unless expressly designated as a high reliability product or a product for harsh environments in a Renesas Electronics data sheet or other Renesas Electronics document, Renesas Electronics products are not intended or authorized for use in products or systems that may pose a direct threat to human life or bodily injury (artificial life support devices or systems; surgical implantations; etc.), or may cause serious property damage (space system; undersea repeaters; nuclear power control systems; aircraft control systems; key plant systems; military equipment; etc.). Renesas Electronics disclaims any and all liability for any damages or losses incurred by you or any third parties arising from the use of any Renesas Electronics product that is inconsistent with any Renesas Electronics data sheet, user's manual or other Renesas Electronics document.
6. When using Renesas Electronics products, refer to the latest product information (data sheets, user's manuals, application notes, "General Notes for Handling and Using Semiconductor Devices" in the reliability handbook, etc.), and ensure that usage conditions are within the ranges specified by Renesas Electronics with respect to maximum ratings, operating power supply voltage range, heat dissipation characteristics, installation, etc. Renesas Electronics disclaims any and all liability for any malfunctions, failure or accident arising out of the use of Renesas Electronics products outside of such specified ranges.
7. Although Renesas Electronics endeavors to improve the quality and reliability of Renesas Electronics products, semiconductor products have specific characteristics, such as the occurrence of failure at a certain rate and malfunctions under certain use conditions. Unless designated as a high reliability product or a product for harsh environments in a Renesas Electronics data sheet or other Renesas Electronics document, Renesas Electronics products are not subject to radiation resistance design. You are responsible for implementing safety measures to guard against the possibility of bodily injury, injury or damage caused by fire, and/or danger to the public in the event of a failure or malfunction of Renesas Electronics products, such as safety design for hardware and software, including but not limited to redundancy, fire control and malfunction prevention, appropriate treatment for aging degradation or any other appropriate measures. Because the evaluation of microcomputer software alone is very difficult and impractical, you are responsible for evaluating the safety of the final products or systems manufactured by you.
8. Please contact a Renesas Electronics sales office for details as to environmental matters such as the environmental compatibility of each Renesas Electronics product. You are responsible for carefully and sufficiently investigating applicable laws and regulations that regulate the inclusion or use of controlled substances, including without limitation, the EU RoHS Directive, and using Renesas Electronics products in compliance with all these applicable laws and regulations. Renesas Electronics disclaims any and all liability for damages or losses occurring as a result of your noncompliance with applicable laws and regulations.
9. Renesas Electronics products and technologies shall not be used for or incorporated into any products or systems whose manufacture, use, or sale is prohibited under any applicable domestic or foreign laws or regulations. You shall comply with any applicable export control laws and regulations promulgated and administered by the governments of any countries asserting jurisdiction over the parties or transactions.
10. It is the responsibility of the buyer or distributor of Renesas Electronics products, or any other party who distributes, disposes of, or otherwise sells or transfers the product to a third party, to notify such third party in advance of the contents and conditions set forth in this document.
11. This document shall not be reprinted, reproduced or duplicated in any form, in whole or in part, without prior written consent of Renesas Electronics.
12. Please contact a Renesas Electronics sales office if you have any questions regarding the information contained in this document or Renesas Electronics products.

(Note1) "Renesas Electronics" as used in this document means Renesas Electronics Corporation and also includes its directly or indirectly controlled subsidiaries.

(Note2) "Renesas Electronics product(s)" means any product developed or manufactured by or for Renesas Electronics.

(Rev.4.0-1 November 2017)

Corporate Headquarters

TOYOSU FORESIA, 3-2-24 Toyosu,
Koto-ku, Tokyo 135-0061, Japan
www.renesas.com

Contact Information

For further information on a product, technology, the most up-to-date version of a document, or your nearest sales office, please visit:
www.renesas.com/contact/

Trademarks

Renesas and the Renesas logo are trademarks of Renesas Electronics Corporation. All trademarks and registered trademarks are the property of their respective owners.