

Introduction

Many recent consumer-electronic devices use multiple power sources for operation. For example, tablet PCs can work from an internal Li-chemistry battery and an external 5V power supply (such as a USB port) during battery charging. In these devices, it is very important to switch between two power rails without a disruptive output voltage drop and at the same time prevent reverse current flowing from the higher voltage rail to the lower voltage rail. Renesas' dual-channel SLG59M1639V or a pair of single-channel, WLCSP SLG59M1748Cs are excellent choices for these types of applications.

Multiplexing Two Power Rails Circuit Design and Analysis

Fig 1 shows circuit examples of multiplexing two power rails to one common output using a dual-channel load switch (Fig 1a) or a pair of single channel load switches (Fig 1b). The SLG59M1639V is a dual-channel, 45-mΩ PMOS load switch designed to switch 1.5V to 5V power rails up to 2A in each channel, while the SLG59M1748C is a single-channel, 35-mΩ PMOS load switch designed to switch 1.6V to 5V power rails up to 2.2A. Both load switches' feature true reverse current blocking and fast reverse-current detection response time. If $V_{OUT} > V_{IN}$ by 50mV, the switch is automatically turned off.

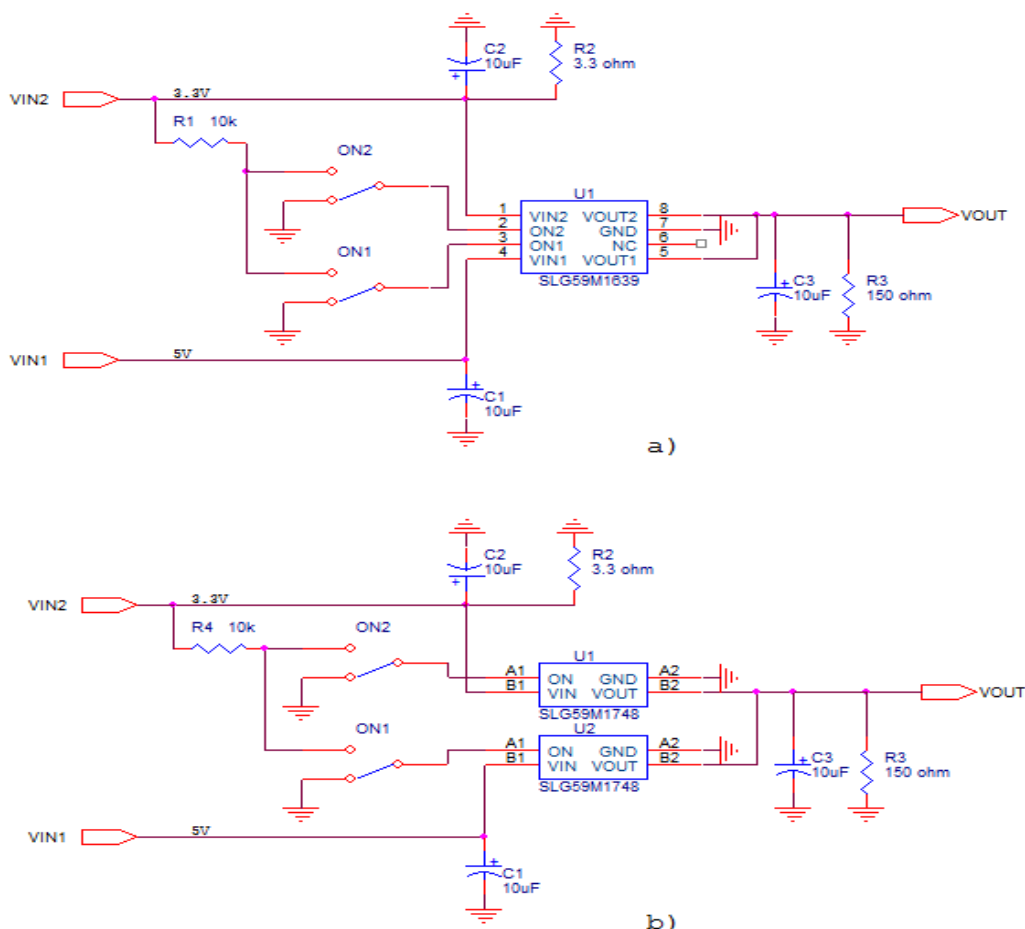

Figure 1. Multiplexing Two Power Rails using GreenFET Load Switch

Since the $R_{DS(ON)}$ of either load switch is very small, the power sources must be tolerant to 1-1.1A reverse-current levels during switch over, as voltage drop in those cases can be less than the 50mV the reverse-current detect threshold.

In some applications, there are a number of components at the VIN2 terminal where the total current at that node will be approximate to or higher than 1A. In this case, it may not be necessary to use R2. In the case where VIN1 (the higher power rail) is already turned ON and it needs to switch to VIN2 (lower power rail) and toggling ON2 High, it is obligatory to toggle ON1 Low, otherwise VOUT will still be closed to the VIN1 rail. An example of such an operation is illustrated in the waveform of Figure 5. To minimize 5V → 3.3V → 5V switchover transients, ON1 can be toggled Low or High while ON2 is always high. Examples of such operation is illustrated in the waveforms shown in Figures 3 and 4. To reduce voltage drop during a 5V to 3.3V switchover, it is possible to use a larger C_{LOAD} (C3) or a larger R_{LOAD} (R3). An example of such improvement is illustrated in the waveform shown in Figure 7.

Operation waveforms

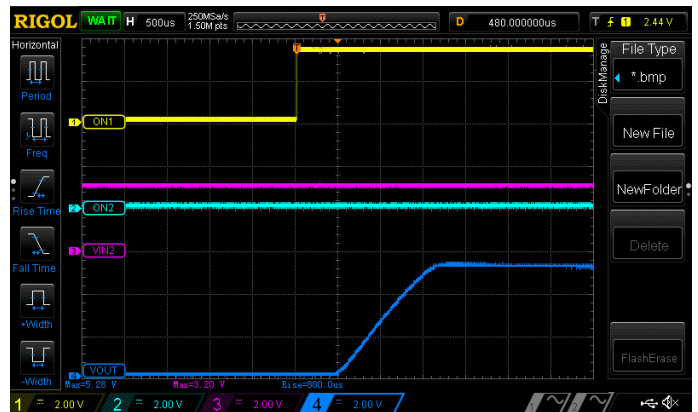

Figure 3. Waveform 2: 5V Power-up Operation

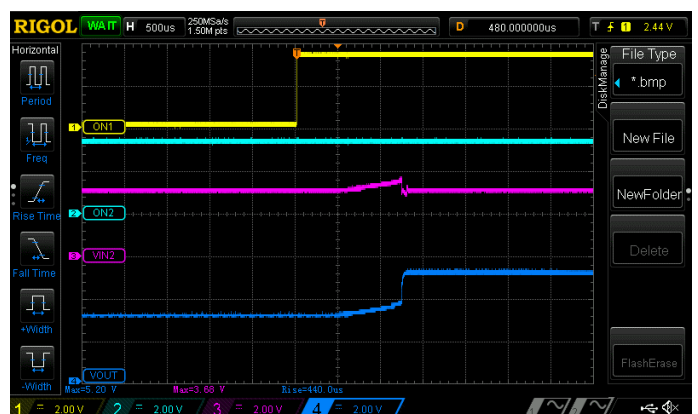

Figure 4. Waveform 3: 3.3V to 5V VOUT Switchover Transient Behavior

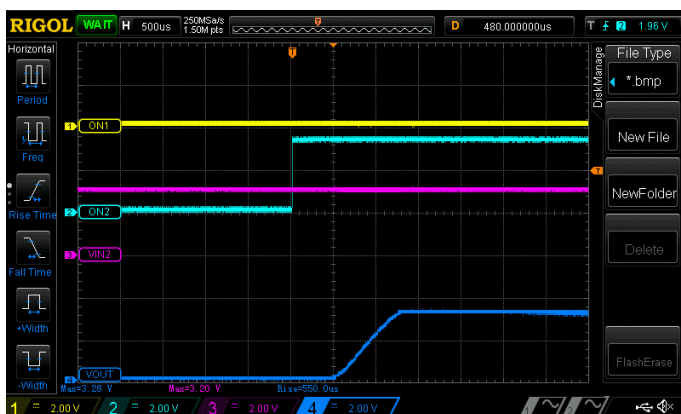

Figure 2. Waveform 1: 3.3V Power-up Operation

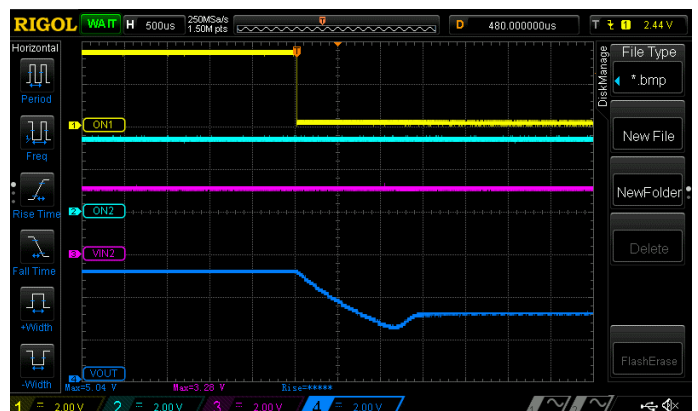

Figure 5. Waveform 4: 5V to 3.3V VOUT Switchover Transient Behavior

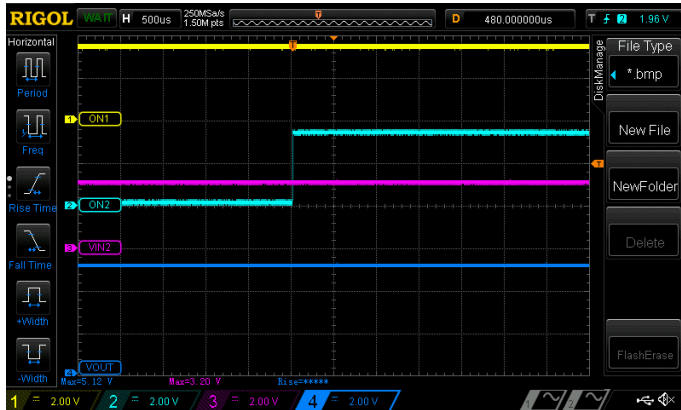

Figure 6. Waveform 5: Not switching to VIN2 if VIN1 turned on

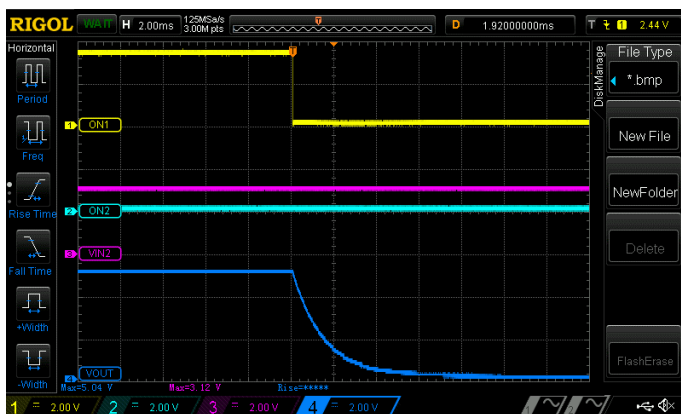

Figure 7. Waveform 6: 5V VOUT Power-down Behavior

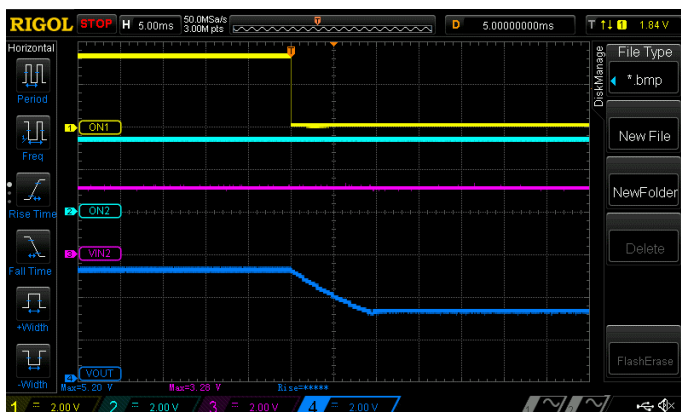

Figure 8. Waveform 7: 5V to 3.3V VOUT Switchover Transient Behavior with C3 = 100μF, R3 = 150Ω

Conclusion

Using Renesas' dual-channel SLG59M1639V or a pair of single-channel SLG59M1748C devices makes it easy to multiplex two power rails to one common output. This application is very often used for switching between external and internal power sources in tablet PCs, smartphones, and other consumer electronic products. Also, it is possible to implement a similar solution using Renesas' SLG59M1641V with active LOW ON-OFF control and faster turn on/off times instead of the SLG59M1639V.

IMPORTANT NOTICE AND DISCLAIMER

RENESAS ELECTRONICS CORPORATION AND ITS SUBSIDIARIES (“RENESAS”) PROVIDES TECHNICAL SPECIFICATIONS AND RELIABILITY DATA (INCLUDING DATASHEETS), DESIGN RESOURCES (INCLUDING REFERENCE DESIGNS), APPLICATION OR OTHER DESIGN ADVICE, WEB TOOLS, SAFETY INFORMATION, AND OTHER RESOURCES “AS IS” AND WITH ALL FAULTS, AND DISCLAIMS ALL WARRANTIES, EXPRESS OR IMPLIED, INCLUDING, WITHOUT LIMITATION, ANY IMPLIED WARRANTIES OF MERCHANTABILITY, FITNESS FOR A PARTICULAR PURPOSE, OR NON-INFRINGEMENT OF THIRD-PARTY INTELLECTUAL PROPERTY RIGHTS.

These resources are intended for developers who are designing with Renesas products. You are solely responsible for (1) selecting the appropriate products for your application, (2) designing, validating, and testing your application, and (3) ensuring your application meets applicable standards, and any other safety, security, or other requirements. These resources are subject to change without notice. Renesas grants you permission to use these resources only to develop an application that uses Renesas products. Other reproduction or use of these resources is strictly prohibited. No license is granted to any other Renesas intellectual property or to any third-party intellectual property. Renesas disclaims responsibility for, and you will fully indemnify Renesas and its representatives against, any claims, damages, costs, losses, or liabilities arising from your use of these resources. Renesas' products are provided only subject to Renesas' Terms and Conditions of Sale or other applicable terms agreed to in writing. No use of any Renesas resources expands or otherwise alters any applicable warranties or warranty disclaimers for these products.

(Disclaimer Rev.1.01 Jan 2024)

Corporate Headquarters

TOYOSU FORESIA, 3-2-24 Toyosu,
Koto-ku, Tokyo 135-0061, Japan
www.renesas.com

Trademarks

Renesas and the Renesas logo are trademarks of Renesas Electronics Corporation. All trademarks and registered trademarks are the property of their respective owners.

Contact Information

For further information on a product, technology, the most up-to-date version of a document, or your nearest sales office, please visit www.renesas.com/contact-us/.